

2J7050BGFa

CELLULAR/LTE MIMO, 2.4/5.0 GHz ISM MIMO and GNSS

Key Features

Cable 1 and 2: CELLULAR / LTE

Cable 3 and 4: 2.4/5.0 GHz ISM

Cable 5: GPS/GLONASS/QZSS/Galileo

Screw Mount

Heavy Duty antenna

High Performance

Ground Plane Independent

Anti-Rotation Mounting

Customizable Cable and Connector

Dimensions: Ø 96 x H 90 mm

Certificates: IP67, IP69, IK09

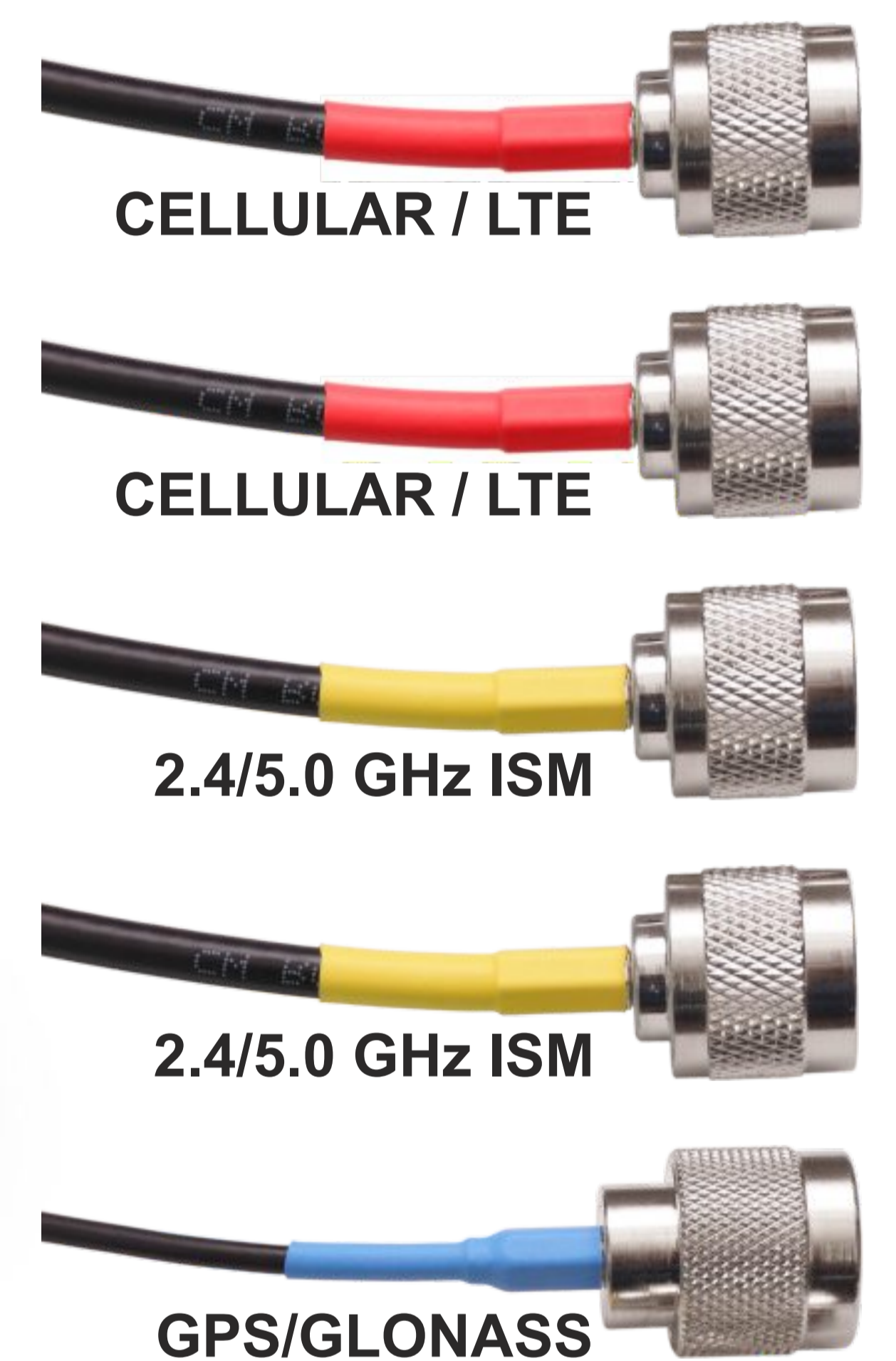

1. Antenna Description

2J7050BGFa

The heavy-duty antenna that offers multiple technologies in one small form factor

With one of the smallest form factor designs, this antenna is packed with a 5-in-1 configuration. Providing connectivity for LTE-MIMO, Dual WiFi-MIMO, GNSS, GPS and GLONASS, it makes it ideal for international use in applications where data integrity is a must. With a high gain and up to 60% efficiency across worldwide 4G LTE, 3G and 2G bands, the 2J7050BGFa antenna makes a superior candidate for high-end public safety applications such as police, ambulance, fire services, HD video broadcasting, resource management, transportation, critical communications and other industries.

Having an extremely low ECC (Envelope Correlation Coefficient) allows for low latency and high data transfer rates. High gain, low noise and post-filtered GNSS allow for more accurate geo-location and navigation, as well as high performance dual WI-FI-MIMO antennas for better signal reception.

The 2J7050BGFa system provides five output cables connected to the respective antennas. Cables one and two allow access to the Cellular/LTE antenna creating the MIMO configuration for this application. Cables three and four are allocated to 2.4GHz and 5.0GHz ISM antennas providing the same MIMO configuration. Cable five serves access to the GPS/GLONASS/GNSS antenna.

Installation

This screw mount antenna comes with low loss cables thread through a single mounting hole for easy installation. This antenna provides an anti-rotation mounting design, removing the possibility of cables getting cut through the lifetime of the product. Cables and connectors can be customized to specific requirements based on the end-use application and needs.

Durability

The IP67 and IP69 ingress ratings provide this compact antenna with maximum protection against dust and water penetration, while the IK09 rating adds an extra level of anti-vandal security, with high impact resistance. This antenna design has also been tested to comply with EN61373 (Vibration and Shock) and EN45545-2 (Fire Protection) for use in railway applications while the UV stable housing material is available in a range of colored finishes.

Typical applications

- Infotainment systems
- WiFi hotspot
- HD video transmission
- Dash cameras
- Connected cars
- Self-driving cars
- Fleet management
- Gateways
- Routers
- Public transportation
- Logistics
- And others

Compatibility Standards

LTE Cables

- CAT 1 2 3 4 5 6 7 8 9 10 11 12
- NB-IoT, LTE-NB1, CAT-M1, CAT-M2WCDMA, UMTS, HSPA,
- EDGE GRPS, GSM, CDMA

2.4/5.0 Cables

- WiFi, Bluetooth, BLE, ISM
- DSRC, V2V, V2X
- Sigfox, LoRa, ZigBee, RPMA, LPWAN

GPS/GLO Cable

- GPS, GLONASS,
- Galileo, QZSS, L1, E1

2. Antenna and electrical specifications

Cable 1

Parameters	CELLULAR / LTE Antenna		
Standards	2G,3G and 4G		
Band (MHz)	700/850/900	1700/1800/1900/2100	2600
Frequency (MHz)	698-960	1710-2170	2500-2700
Return Loss (dB)	~-10.6	~-15.6	~-11.7
VSWR	~1.9:1	~1.6:1	~1.7:1
Efficiency (%)	~57	~57	~47
Peak Gain (dBi)	~2.1	~4.2	~3.1
Average Gain (dB)	~-2.4	~-2.5	~-3.3
Impedance (Ohm)	50		
Polarisation	Linear		
Radiation Pattern	Omni-Directional		
Max. Input Power (W)	25		
Connector Type	Most RF Connectors (SMA-Male Standard)		
Cable Length	Any Cable Length (300 cm Standard)		
Cable Type	Other Cables Available (LMR195 Standard)		

Cable 2

Parameters	CELLULAR / LTE Antenna		
Standards	2G,3G and 4G		
Band (MHz)	700/850/900	1700/1800/1900/2100	2600
Frequency (MHz)	698-960	1710-2170	2500-2700
Return Loss (dB)	~-11.0	~-14.3	~-16.5
VSWR	~1.9:1	~1.6:1	~1.4:1
Efficiency (%)	~63	~54	~57
Peak Gain (dBi)	~3.0	~3.2	~4.0
Average Gain (dB)	~-2.0	~-2.6	~-2.4
Impedance (Ohm)	50		
Polarisation	Linear		
Radiation Pattern	Omni-Directional		
Max. Input Power (W)	25		
Connector Type	Most RF Connectors (SMA-Male Standard)		
Cable Length	Any Cable Length (300 cm Standard)		
Cable Type	Other Cables Available (LMR195 Standard)		

Antenna Measurement Conditions:

Mounted on Metal Plate of 30 x 30 cm

200 cm of LMR195 Cable

Measured in Certified CTIA 3D Anechoic Chamber

Cable 3

Parameters	2.4/5.0 GHz ISM Antenna	
Standards	WiFi, BT, ZigBee, ISM	
Band (MHz)	2.4 GHz	5.0 GHz
Frequency (MHz)	2410-2490	4920-5925
Return Loss (dB)	~-10.4	~-13.6
VSWR	~1.9:1	~1.6:1
Efficiency (%)	~58	~64
Peak Gain (dBi)	~5.6	~5.5
Average Gain (dB)	~-2.3	~-1.9
Impedance (Ohm)	50	
Polarisation	Linear	
Radiation Pattern	Omni-Directional	
Max. Input Power (W)	25	
Connector Type	Most RF Connectors (SMA-Male Standard)	
Cable Length	Any Cable Length (300 cm Standard)	
Cable Type	Other Cables Available (LMR195 Standard)	

Cable 4

Parameters	2.4/5.0 GHz ISM Antenna	
Standards	WiFi, BT, ZigBee, ISM	
Band (MHz)	2.4 GHz	5.0 GHz
Frequency (MHz)	2410-2490	4920-5925
Return Loss (dB)	~-8.9	~-13.6
VSWR	~2.1:1	~1.6:1
Efficiency (%)	~57	~59
Peak Gain (dBi)	~5.5	~4.4
Average Gain (dB)	~-2.4	~-2.3
Impedance (Ohm)	50	
Polarisation	Linear	
Radiation Pattern	Omni-Directional	
Max. Input Power (W)	25	
Connector Type	Most RF Connectors (SMA-Male Standard)	
Cable Length	Any Cable Length (300 cm Standard)	
Cable Type	Other Cables Available (LMR195 Standard)	

Antenna Measurement Conditions:

Mounted on Metal Plate of 30 x 30 cm

200 cm of LMR195 Cable

Measured in Certified CTIA 3D Anechoic Chamber

Cable 5	GPS/GLONASS Antenna	
Parameters	GPS/QZSS/Galileo	GLONASS
Standard	1575	1602
Band (MHz)	1575.42	1598-1610
Frequency(MHz)	<=-14	
Return Loss (dB)	<=1.5:1	
VSWR	50	
Impedance	Hemispherical	
Radiation Pattern	RHCP	
Polarization	Post-Filter	
Saw Filter	23 @ 3 V, 24 @ 5 V	
Active Gain (dB)	1.2	
Noise Figure (dB)	2.7 - 5.5	
Voltage (V)	15 - 25	
Current Consumption (mA)	40.5 - 137.5	
Power Consumption (mW)	~32	
Out of Band Rejection (dBc)	SMA-Male Standard (Other Connectors Available)	
Connector Type	300 cm Standard (Any Cable Length Available)	
Cable Length	LMR100 Standard (Other Cables Available)	
Cable Type		

3. Mechanical and environmental specifications

Specifications	2J7050BGFa
Mounting Type	Screw Mount
Dimensions (mm)	Ø 96 x H 90
Max. Tighten Torque (Nm)	15 Nm
Radome	ASA
Radome color	White, Black
Antenna Base	Alluminium alloy
Operating Temperature (C)	-40 to +85
Storage Temperature (C)	-40 to +85
Substance Compliance	RoHS
Certificates	IP67, IP69, IK09

4. Antenna parameters

Cable 1: CELLULAR/LTE

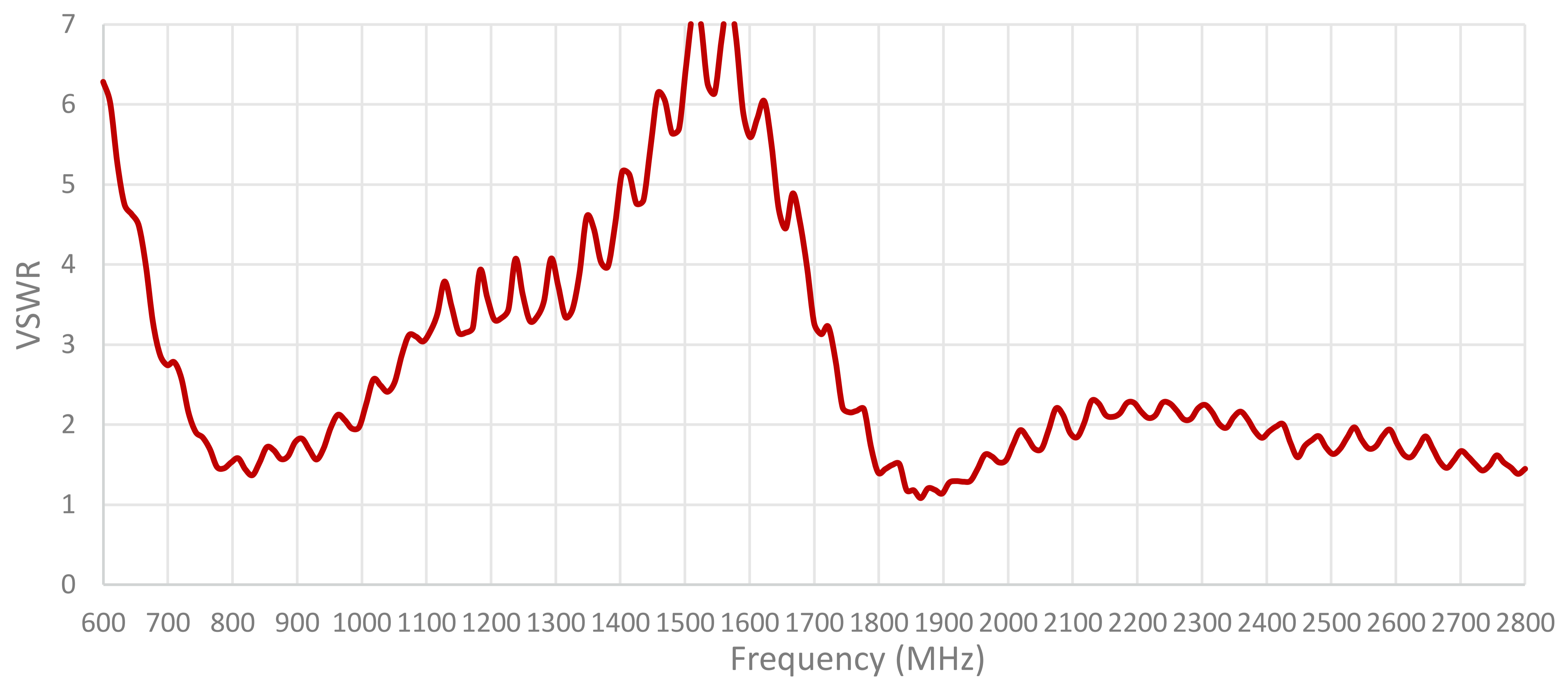
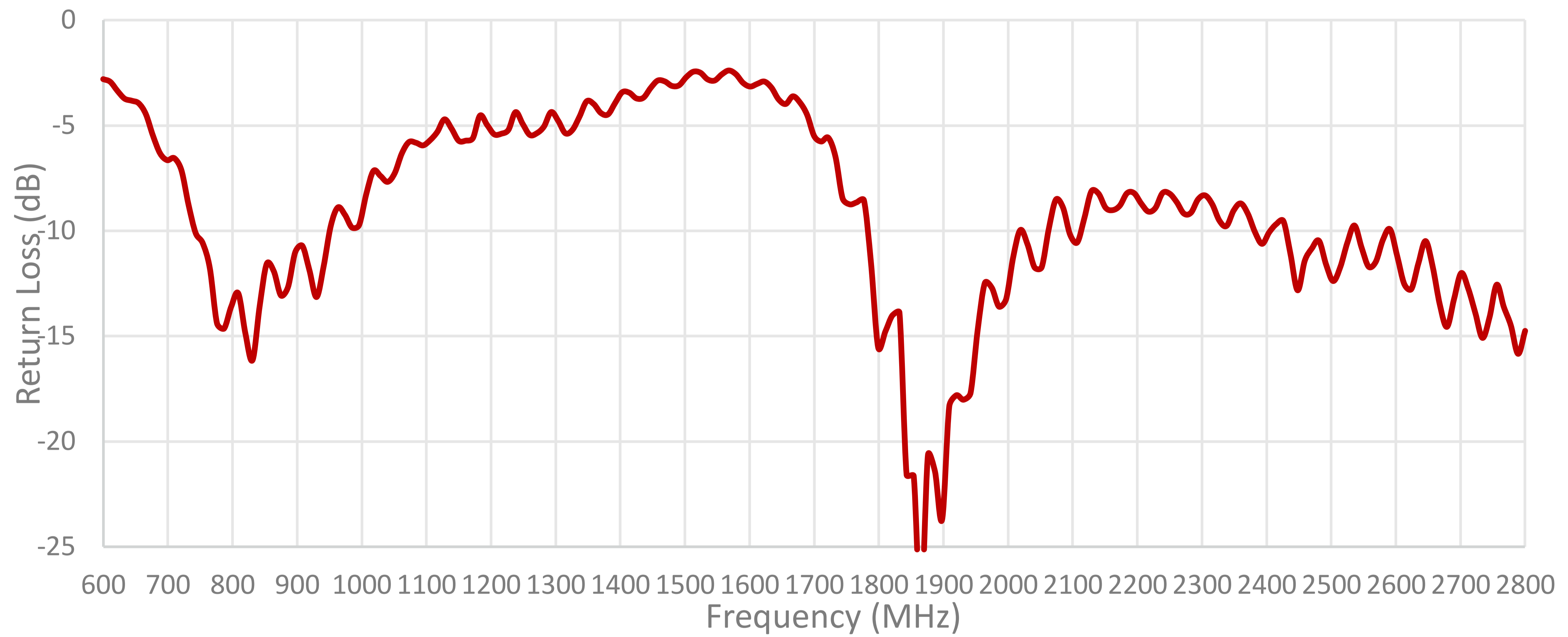

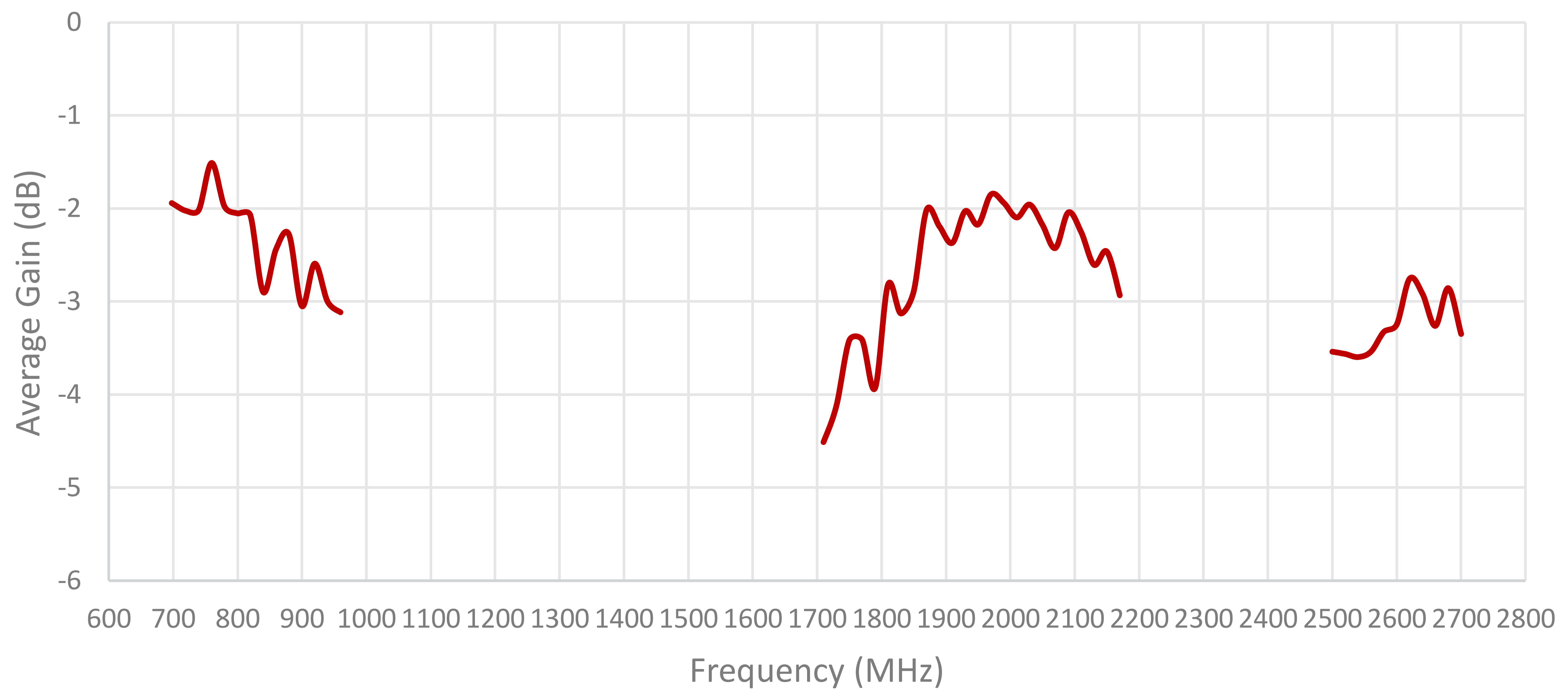
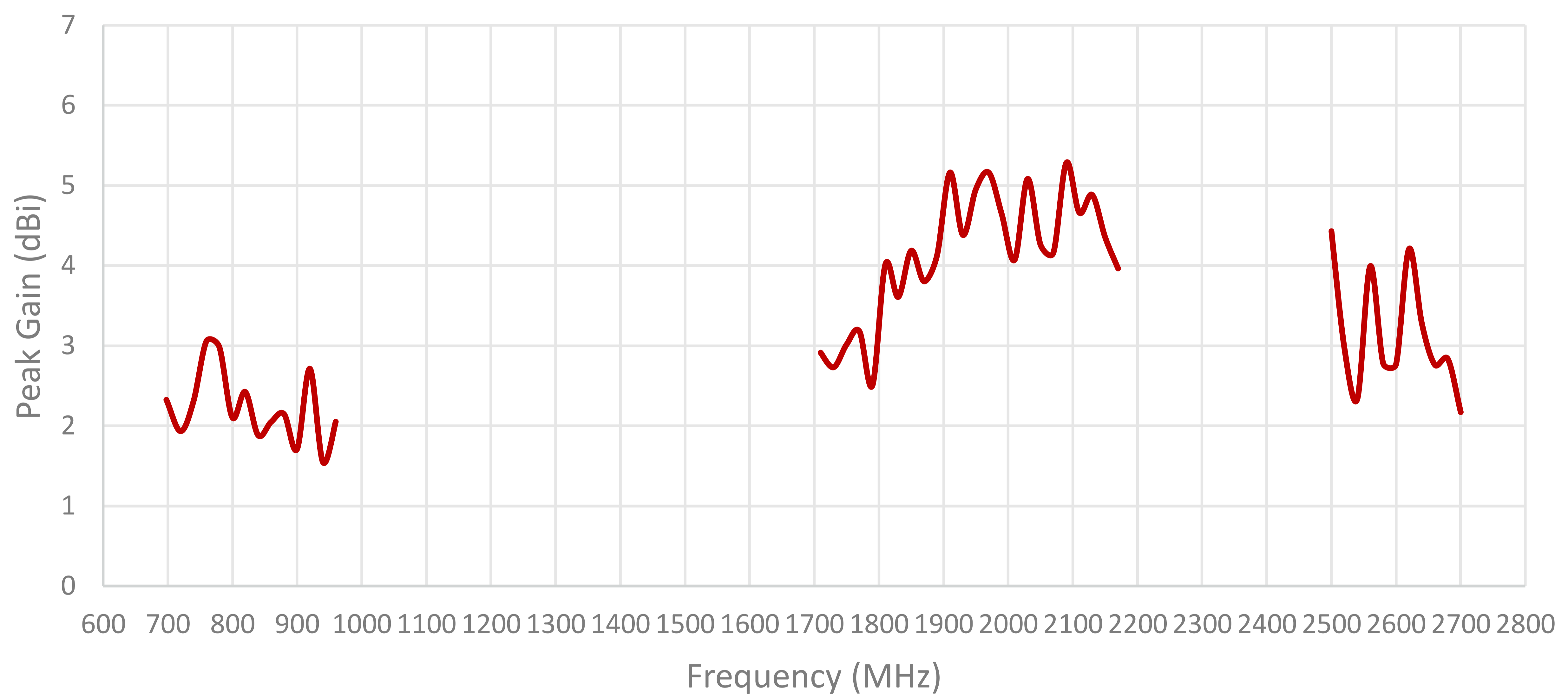
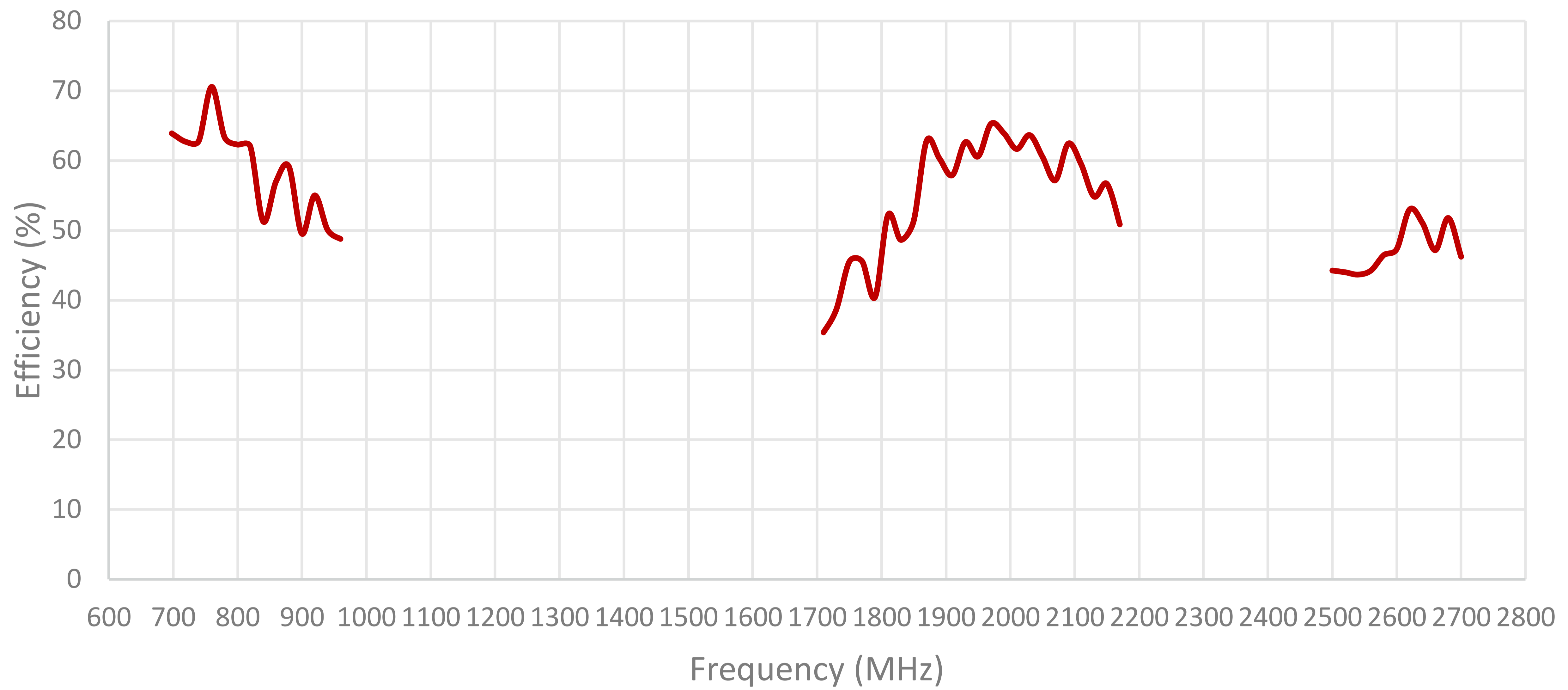

Cable 2: CELLULAR/LTE

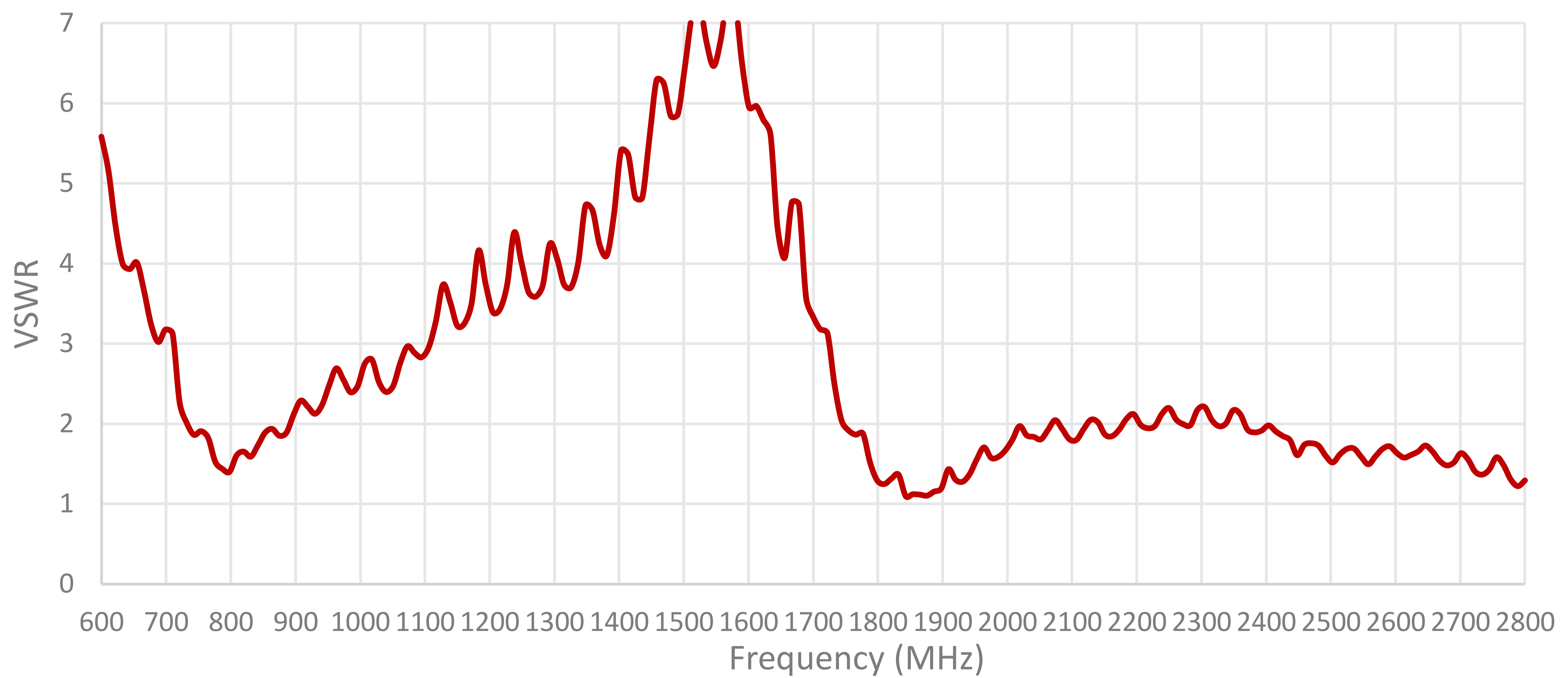
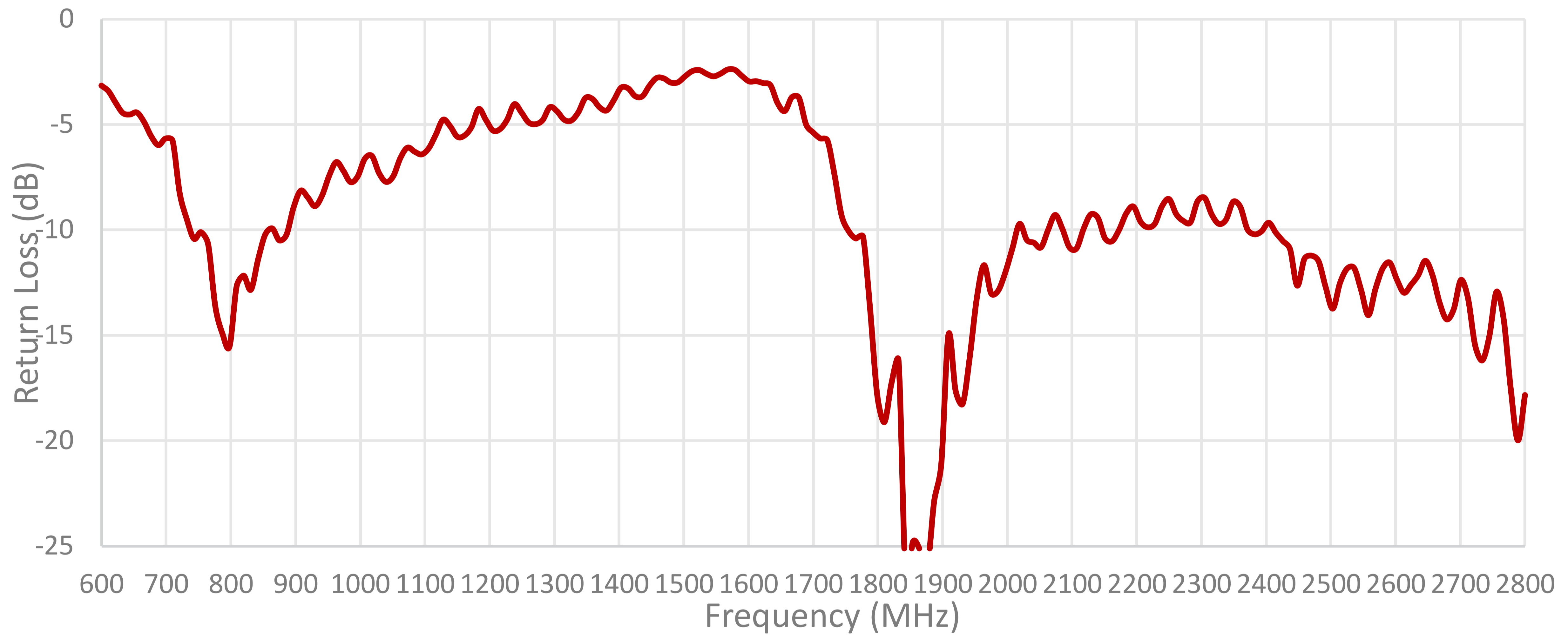

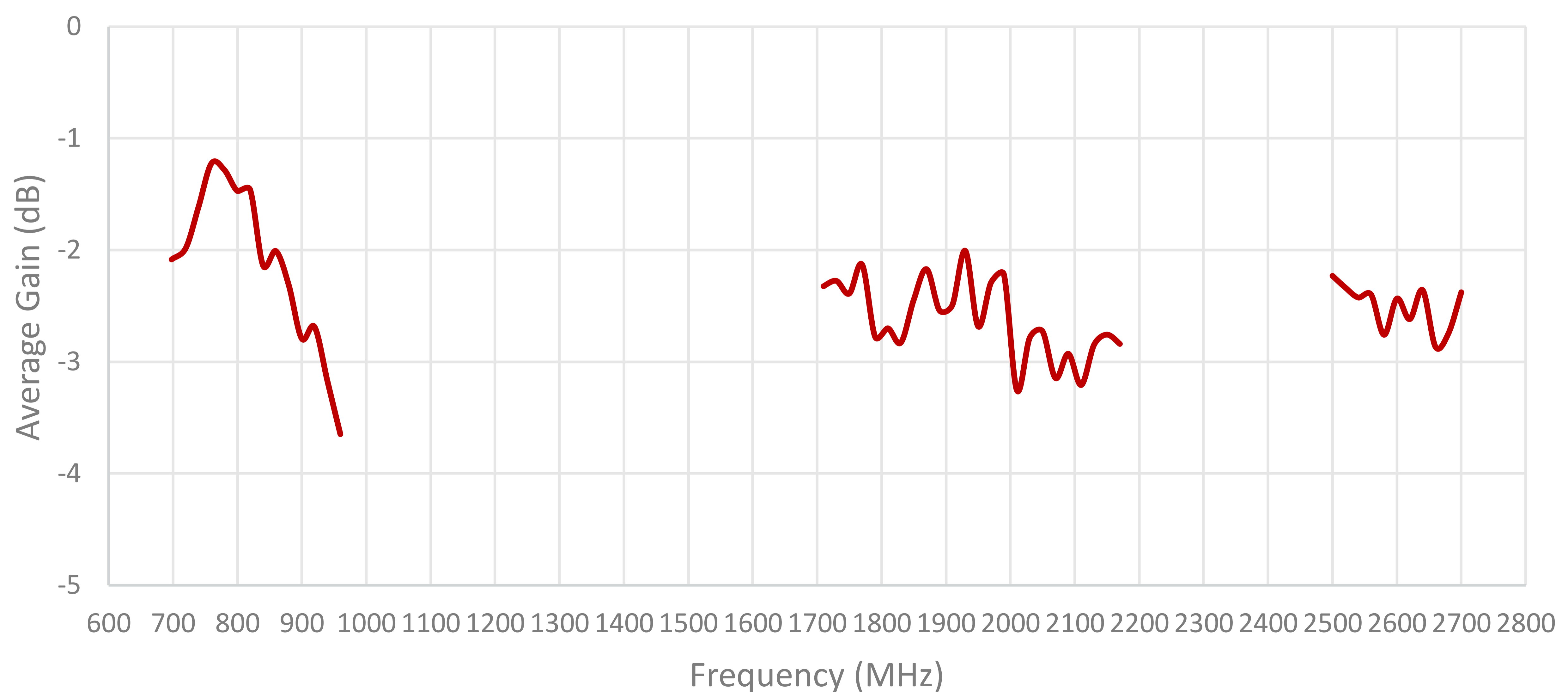
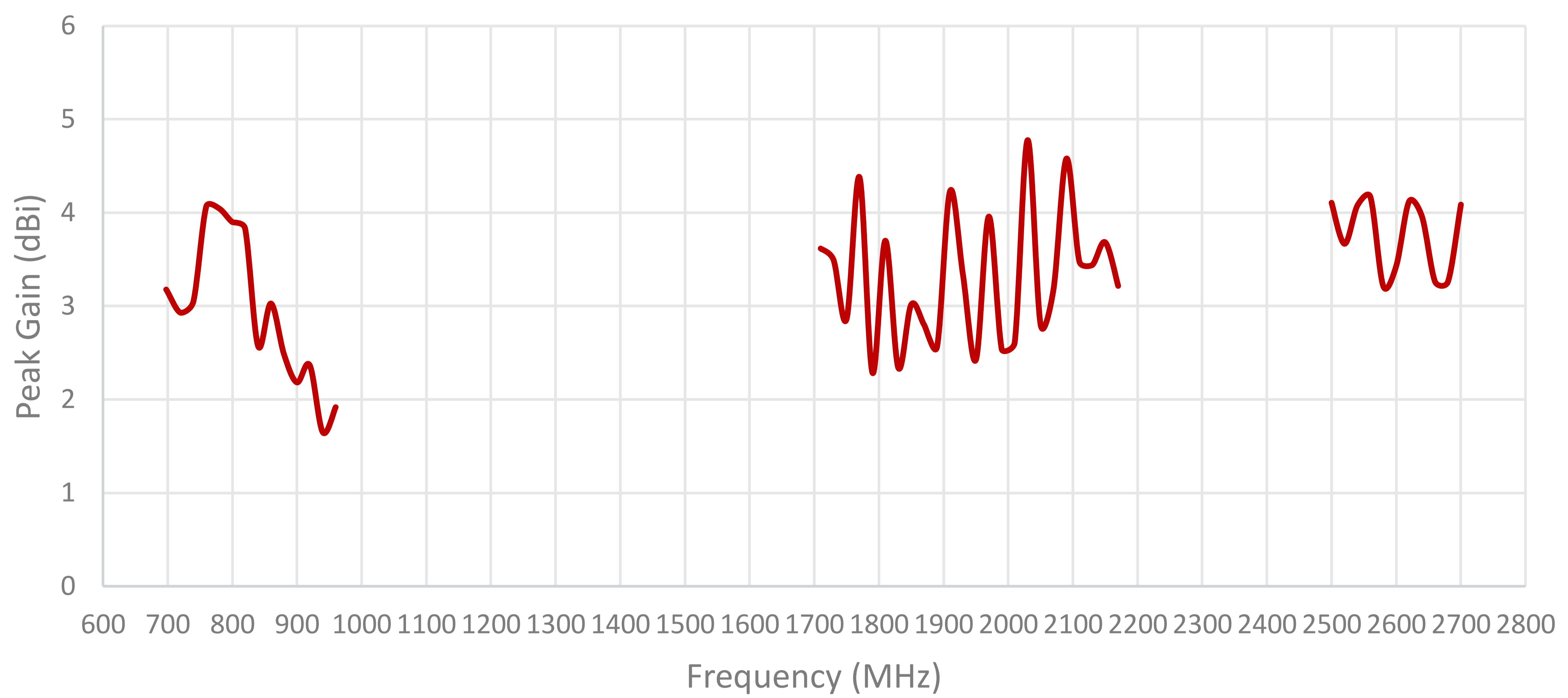
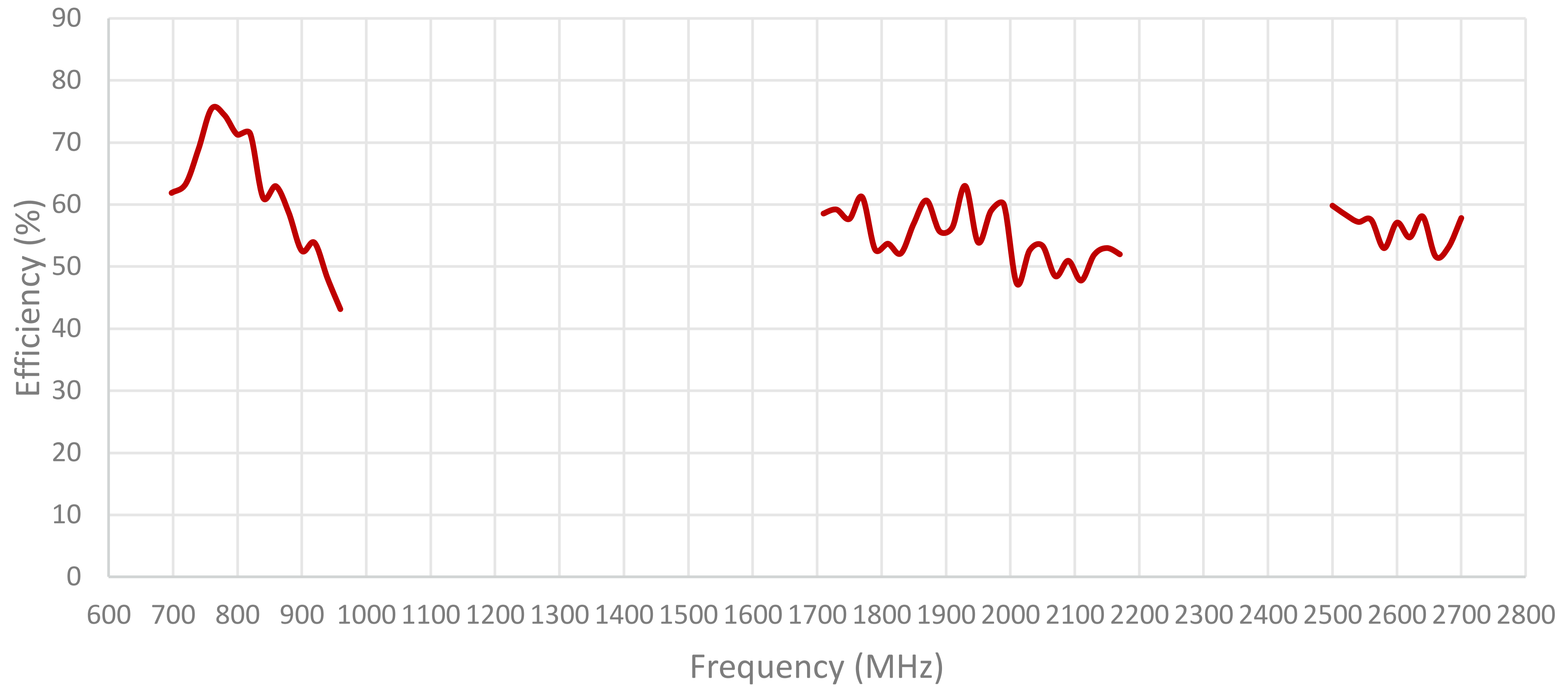

ISOLATION FOR CABLES 1 AND 2

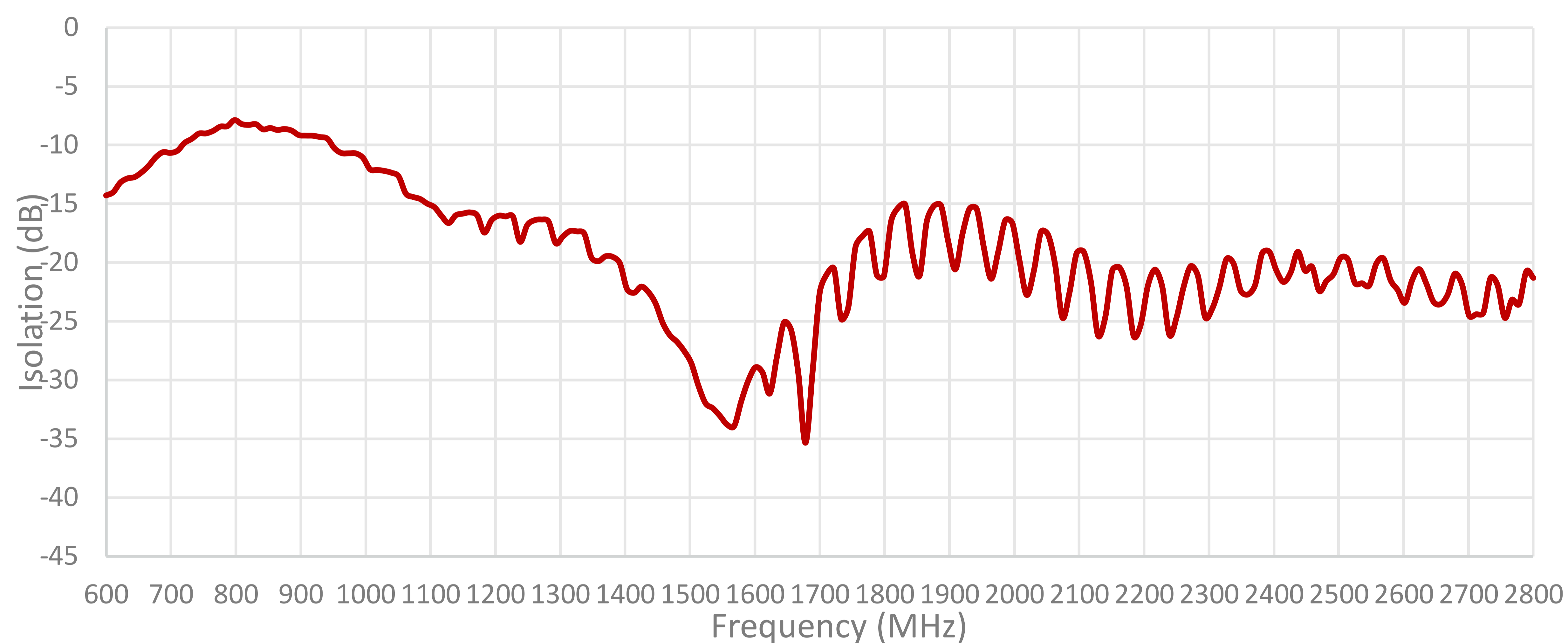

ENVELOPE CORRELATION COEFFICIENT FOR CABLES 1 AND 2

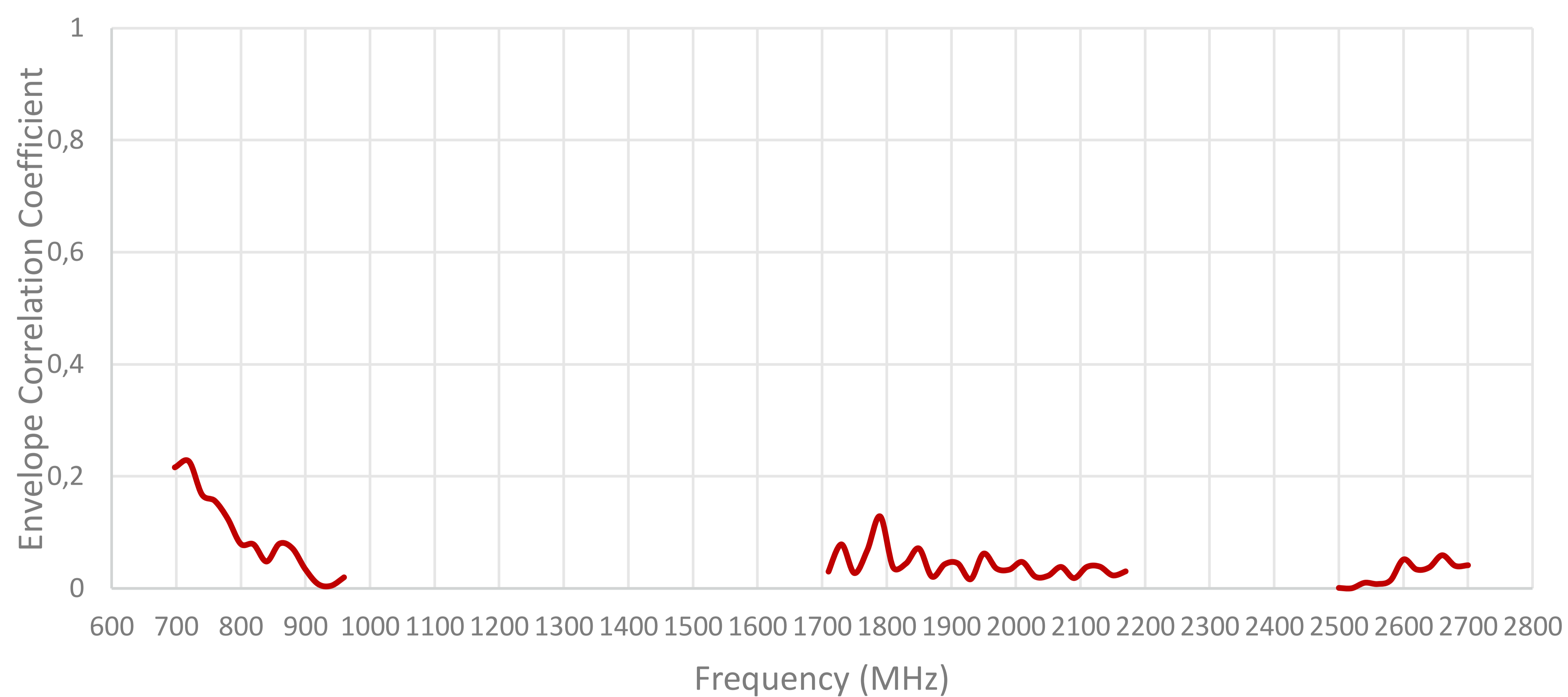

Cable 3: 2.4/5.0 GHz ISM

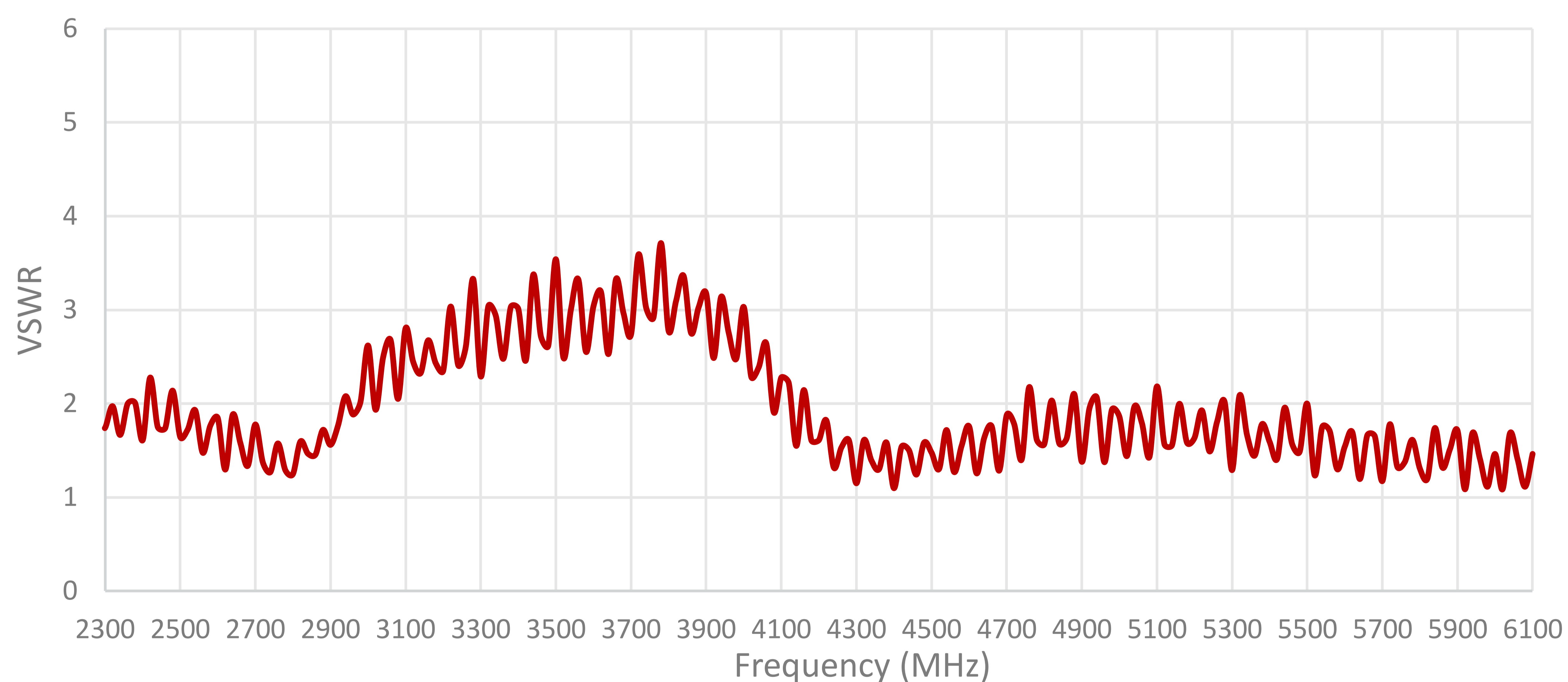
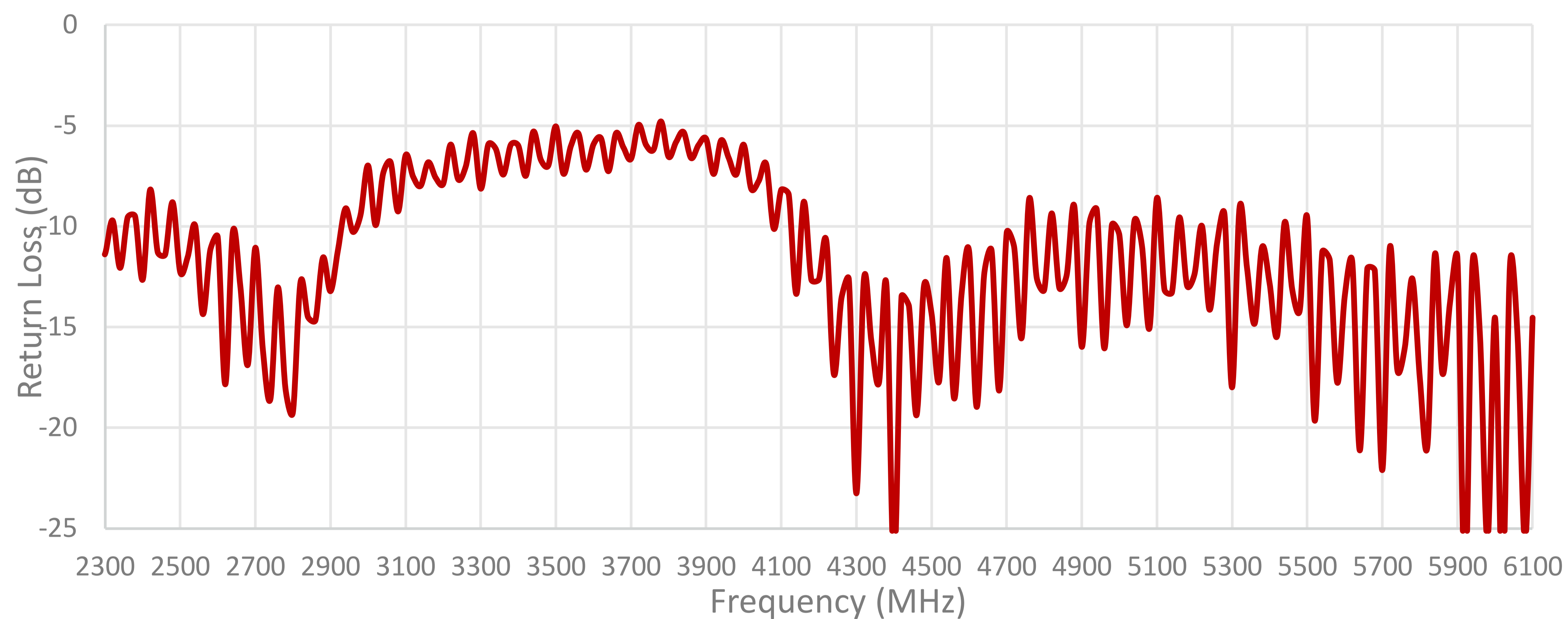

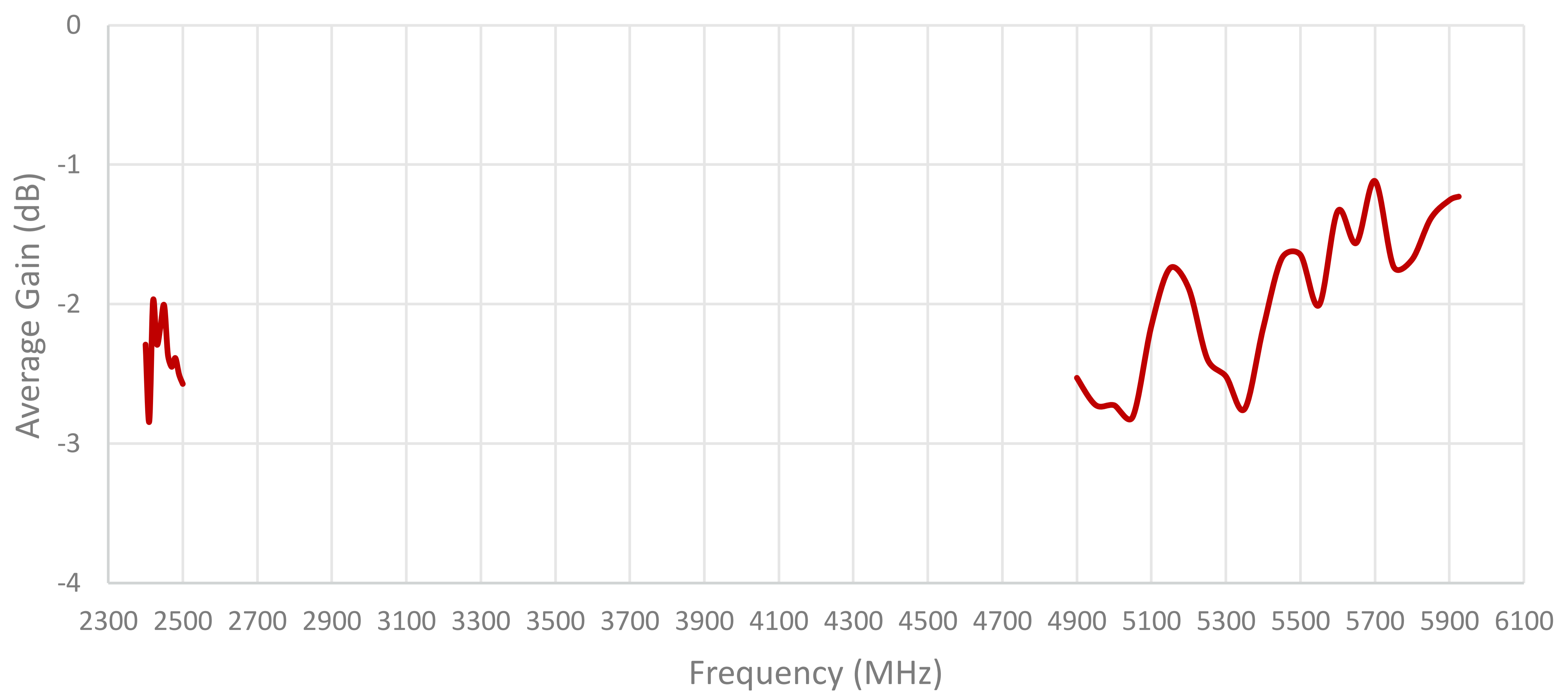
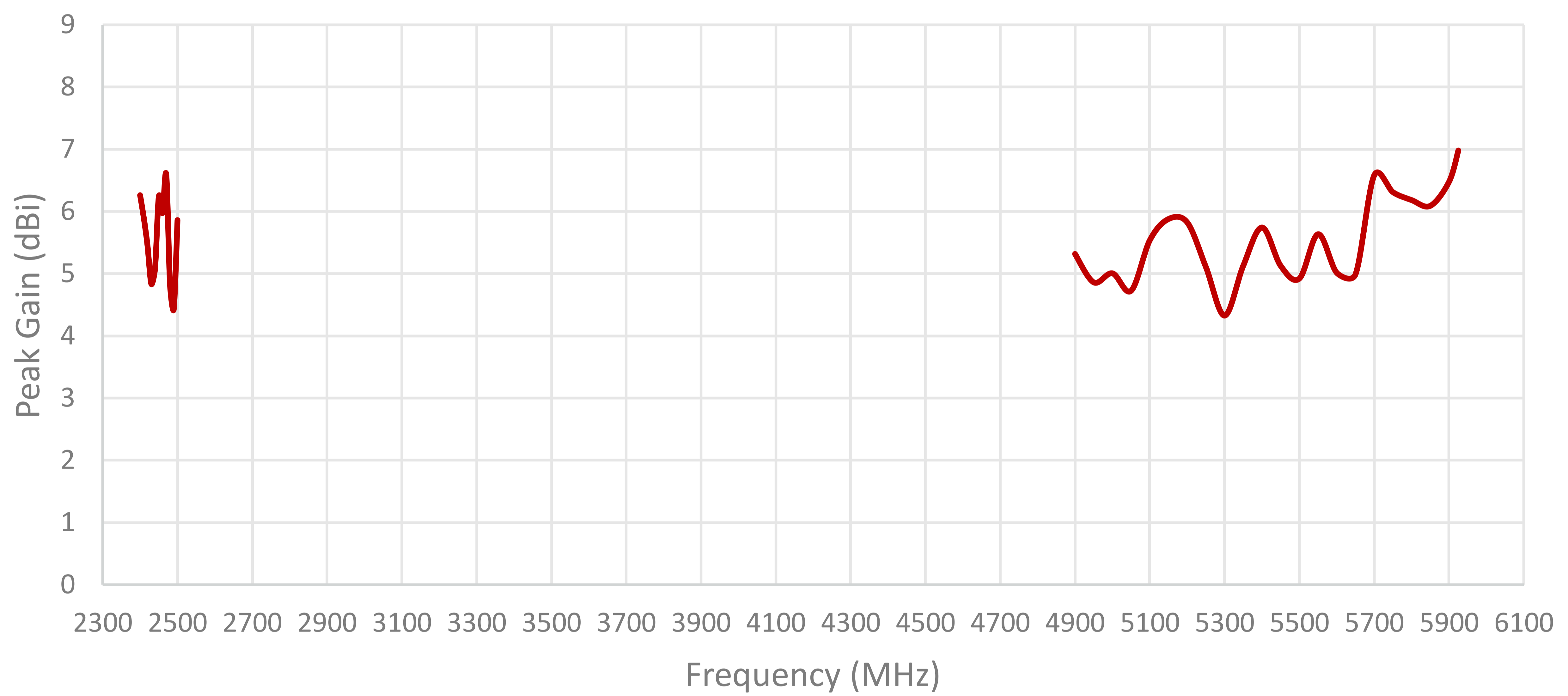
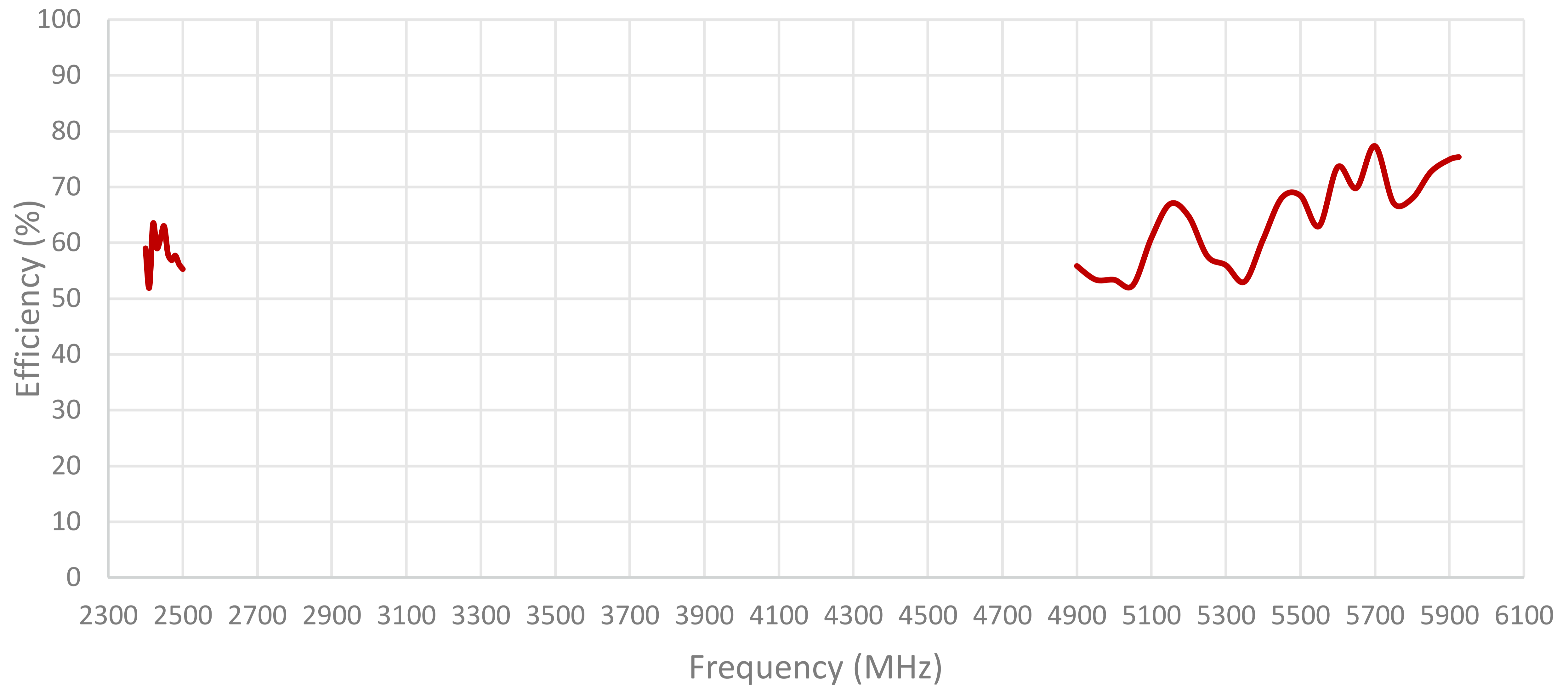

Cable 4: 2.4/5.0 GHz ISM

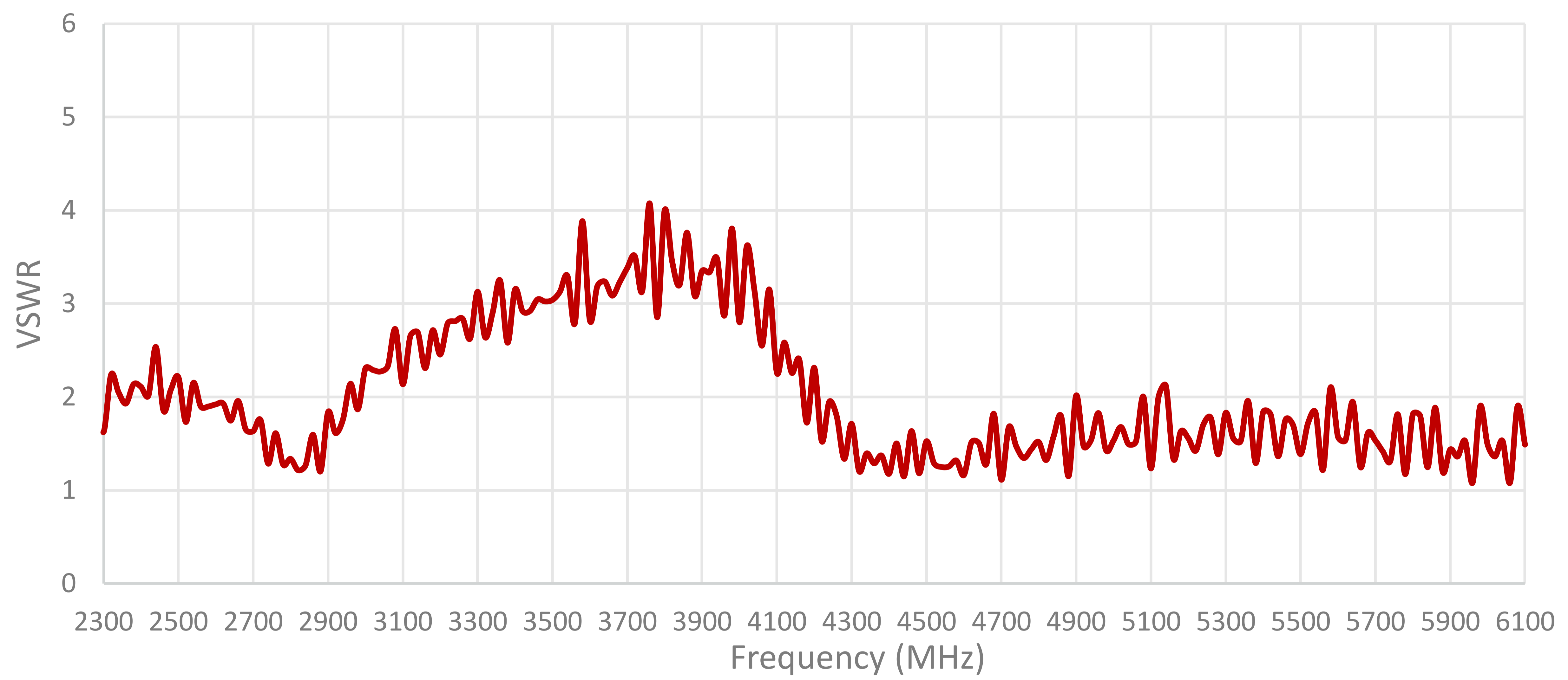
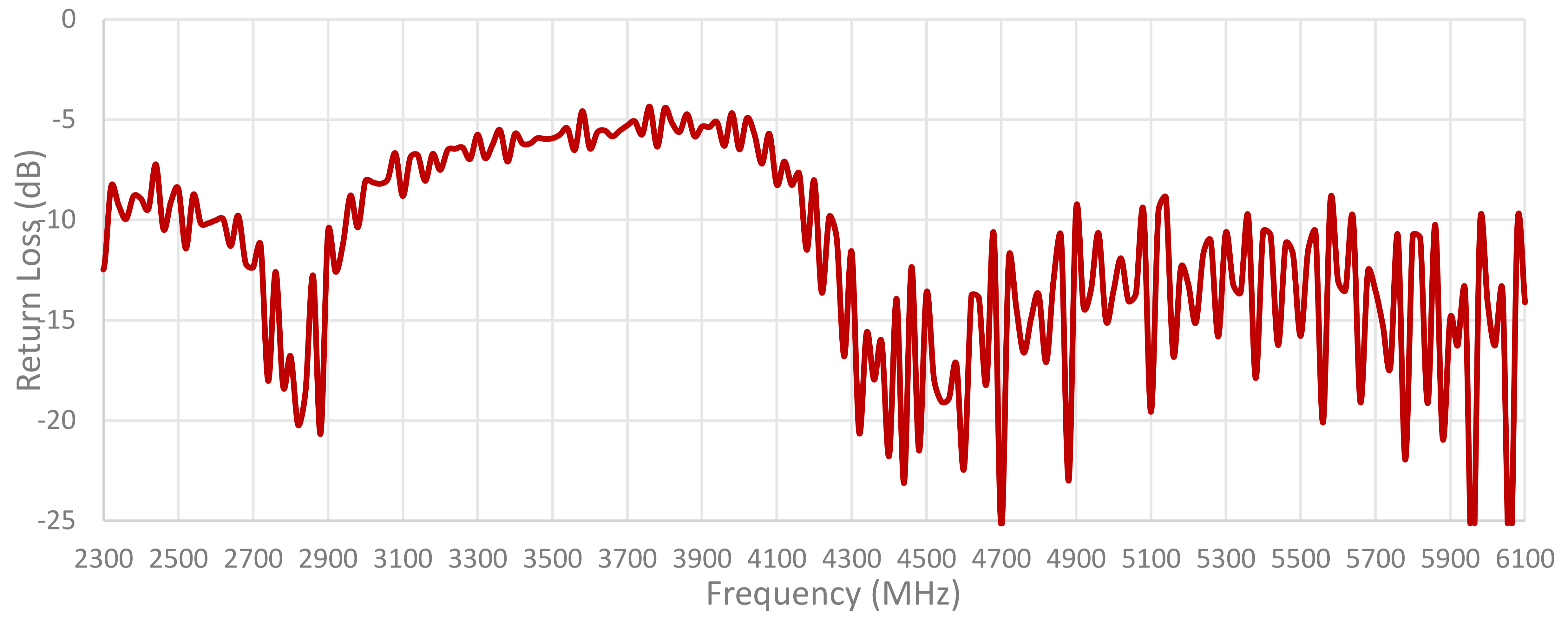

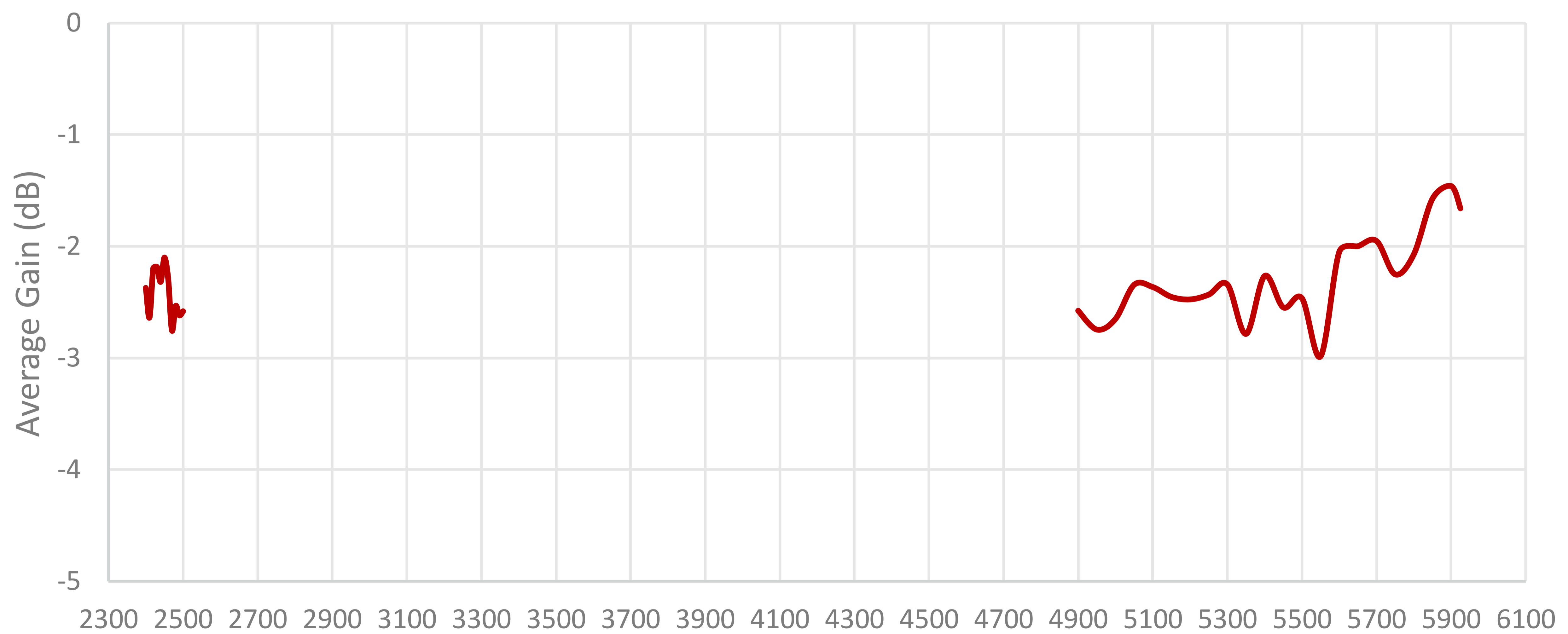
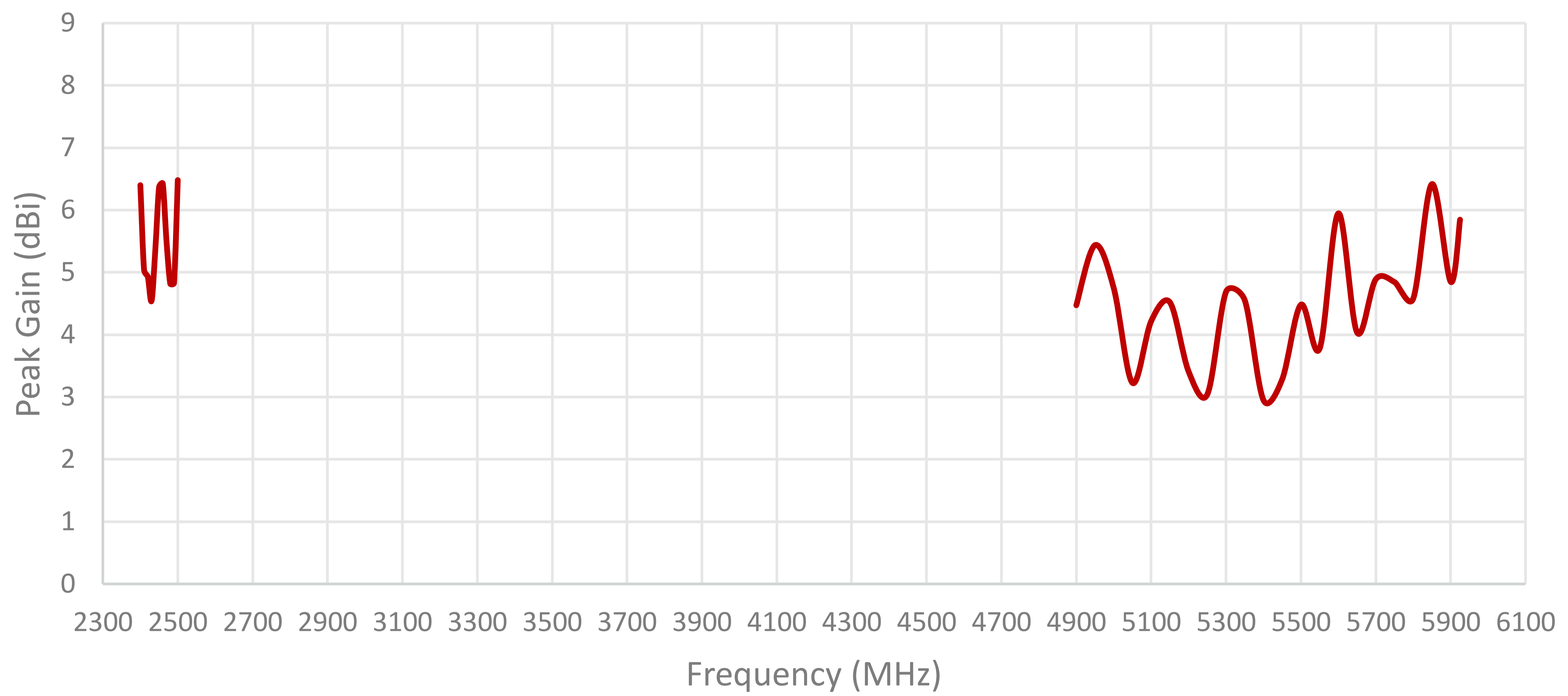
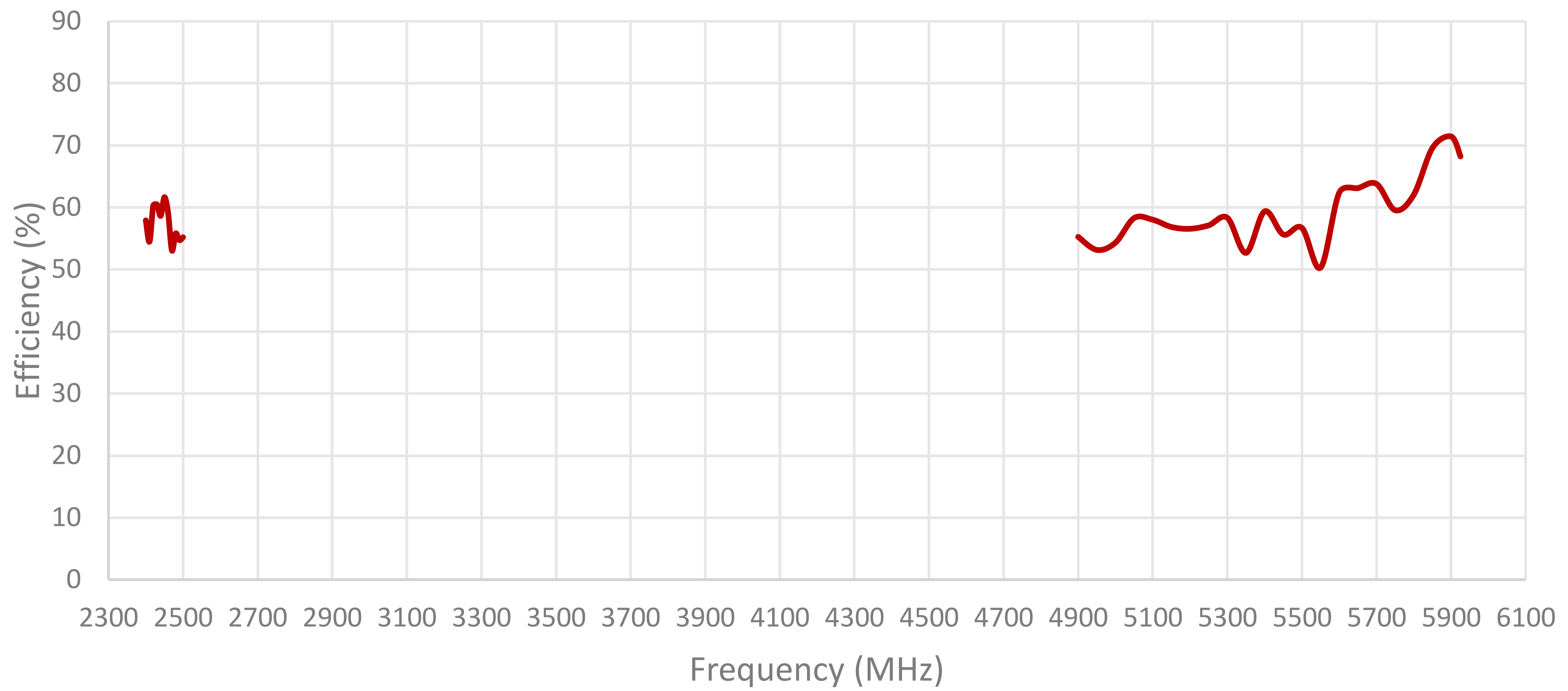

ISOLATION FOR CABLES 3 AND 4

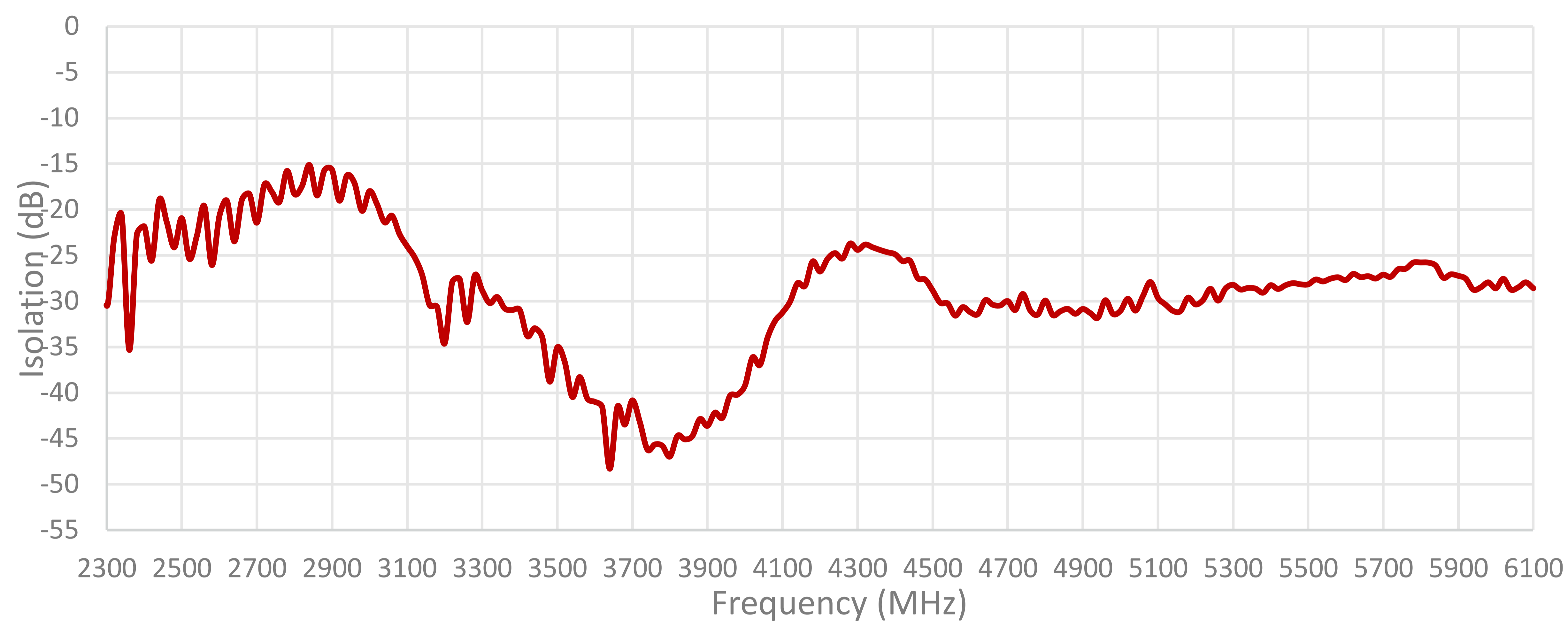

ENVELOPE CORRELATION COEFFICIENT FOR CABLES 3 AND 4

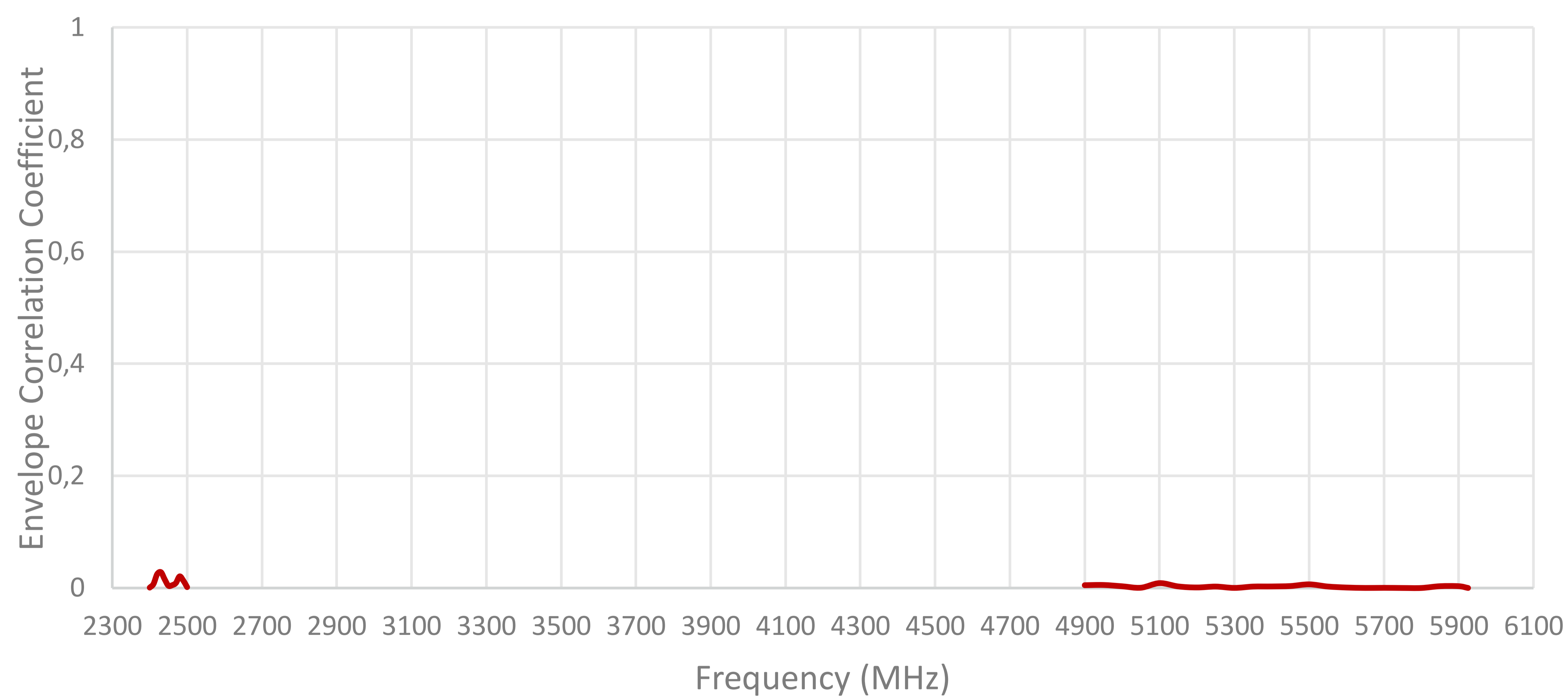

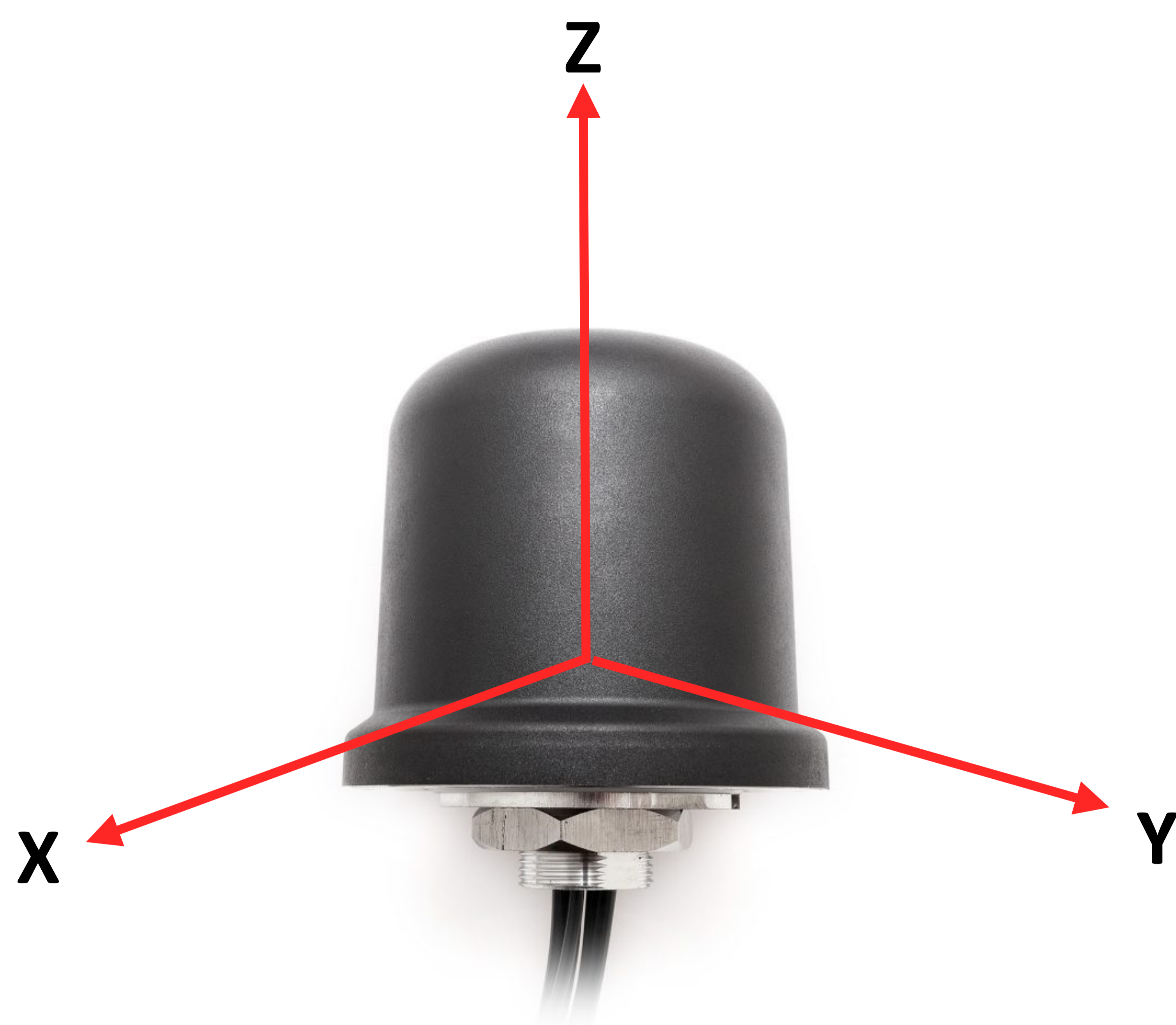

Radiation pattern reference

Cable 1: CELLULAR/LTE

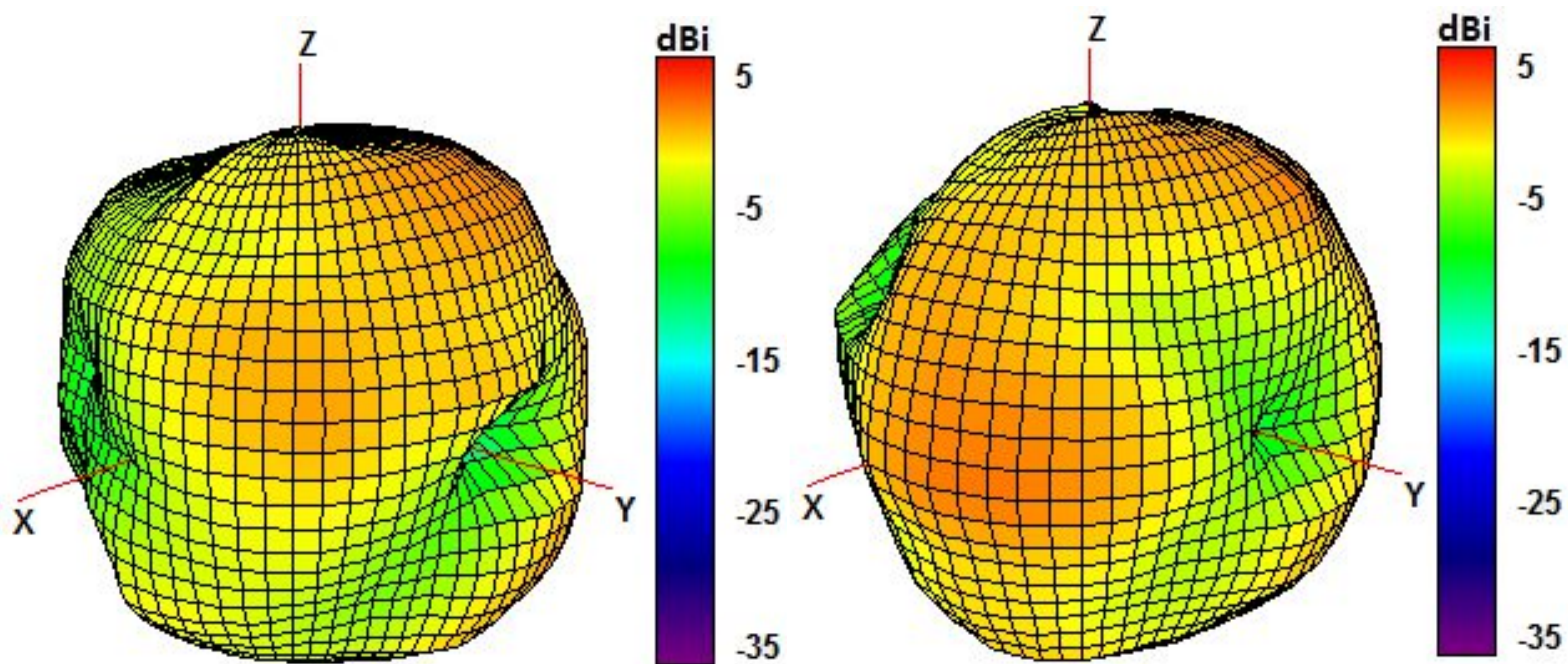

750 and 850 MHz Radiation pattern

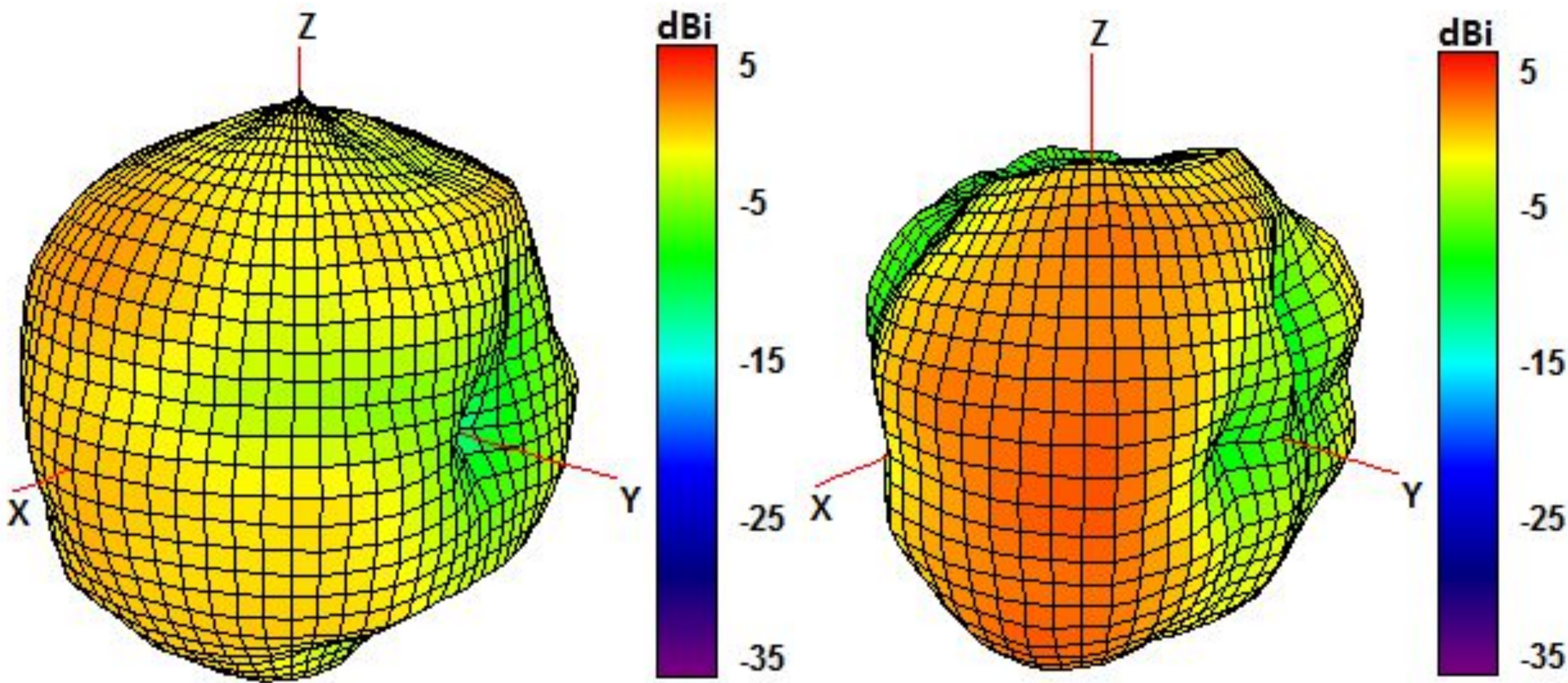

940 and 1750 MHz Radiation pattern

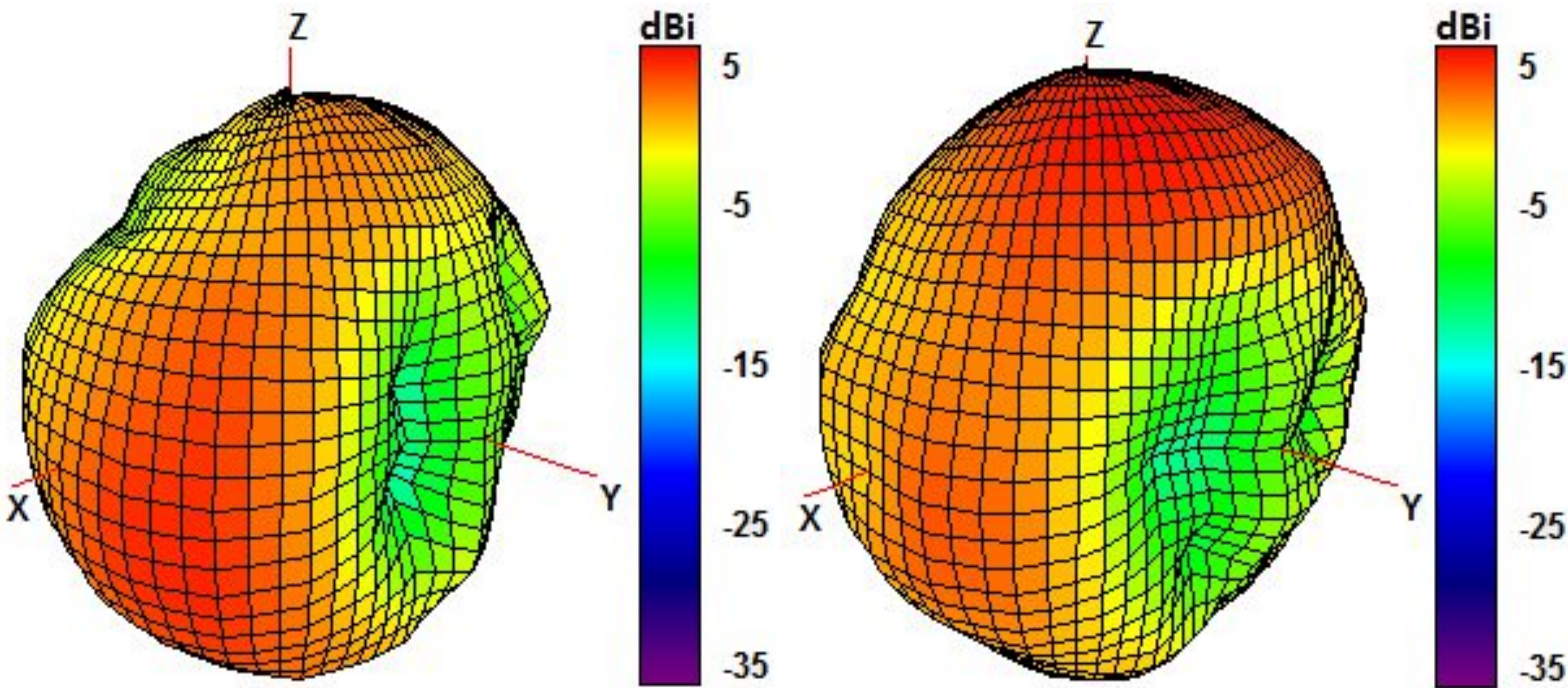

1850 and 1950 MHz Radiation pattern

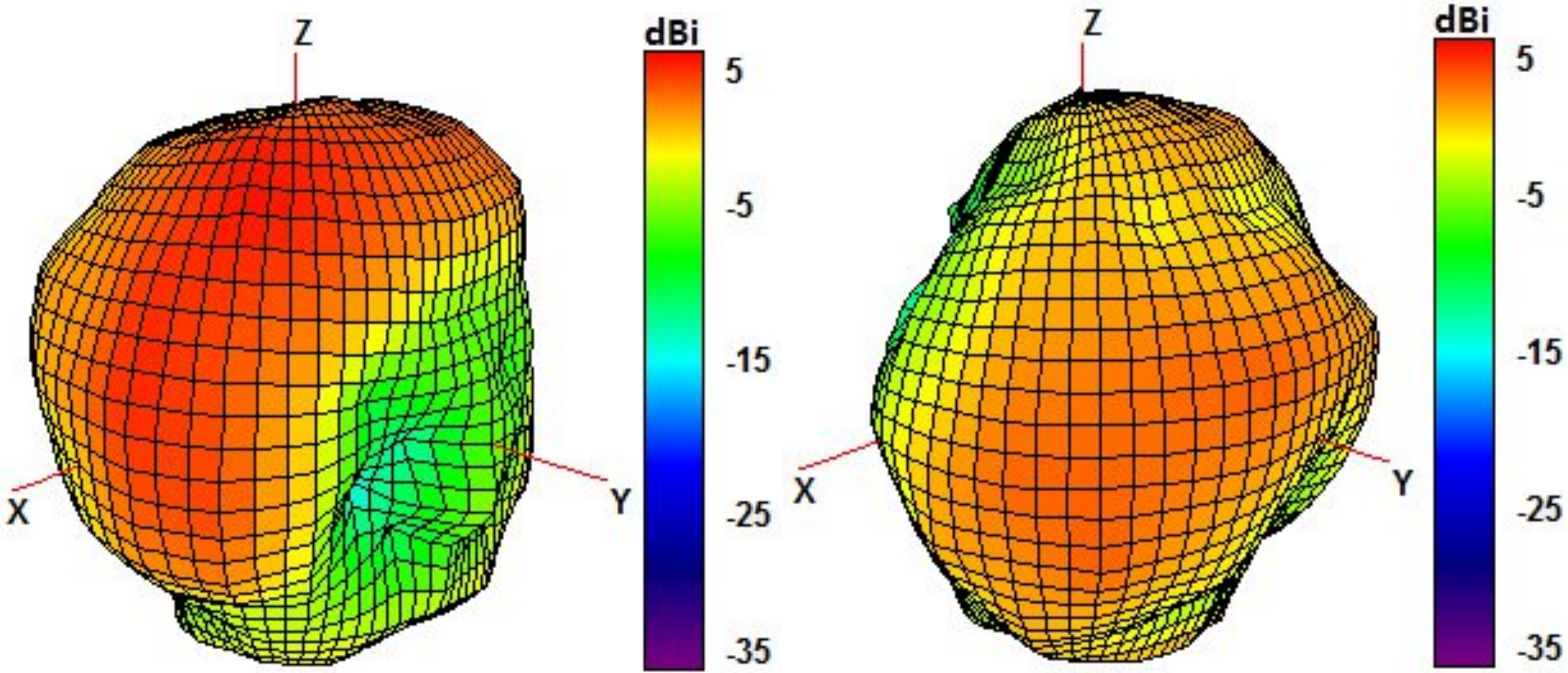

2100 and 2600 MHz Radiation pattern

Cable 2: CELLULAR/LTE

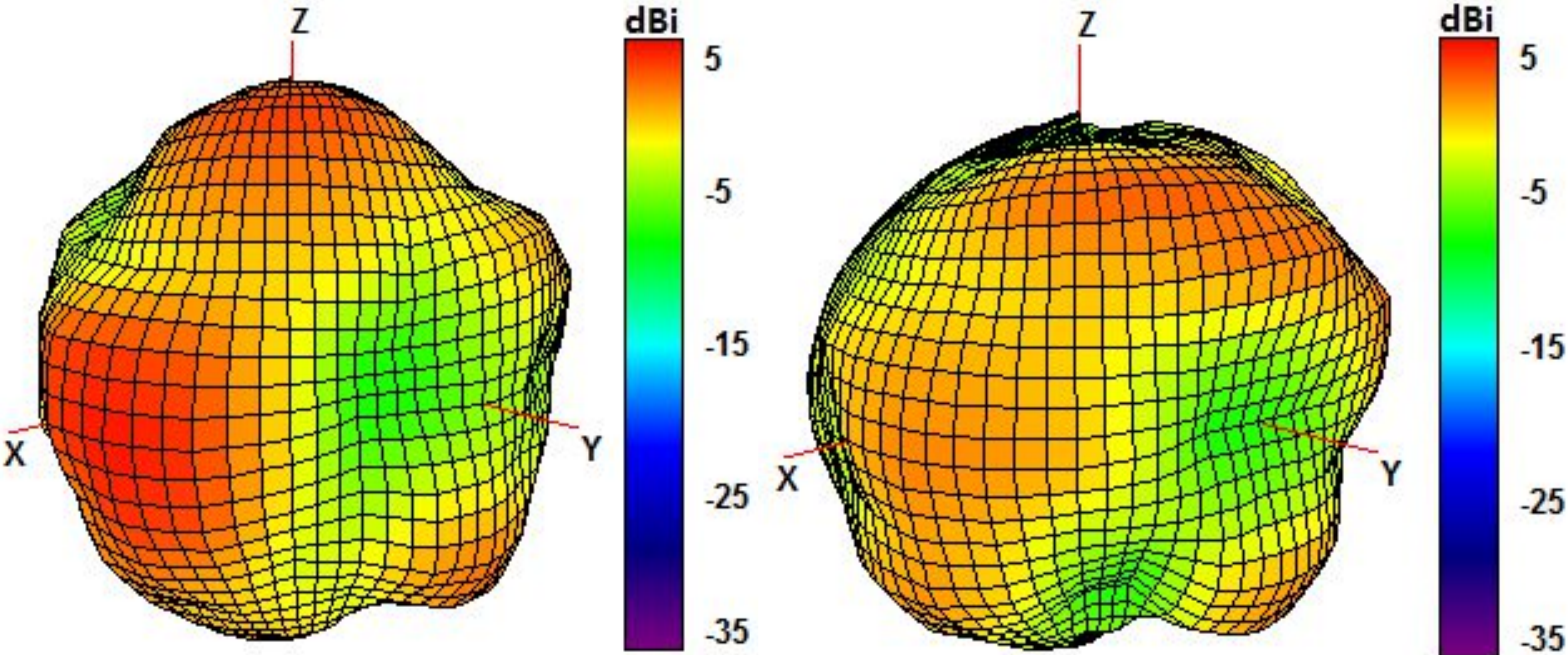

750 and 850 MHz Radiation pattern

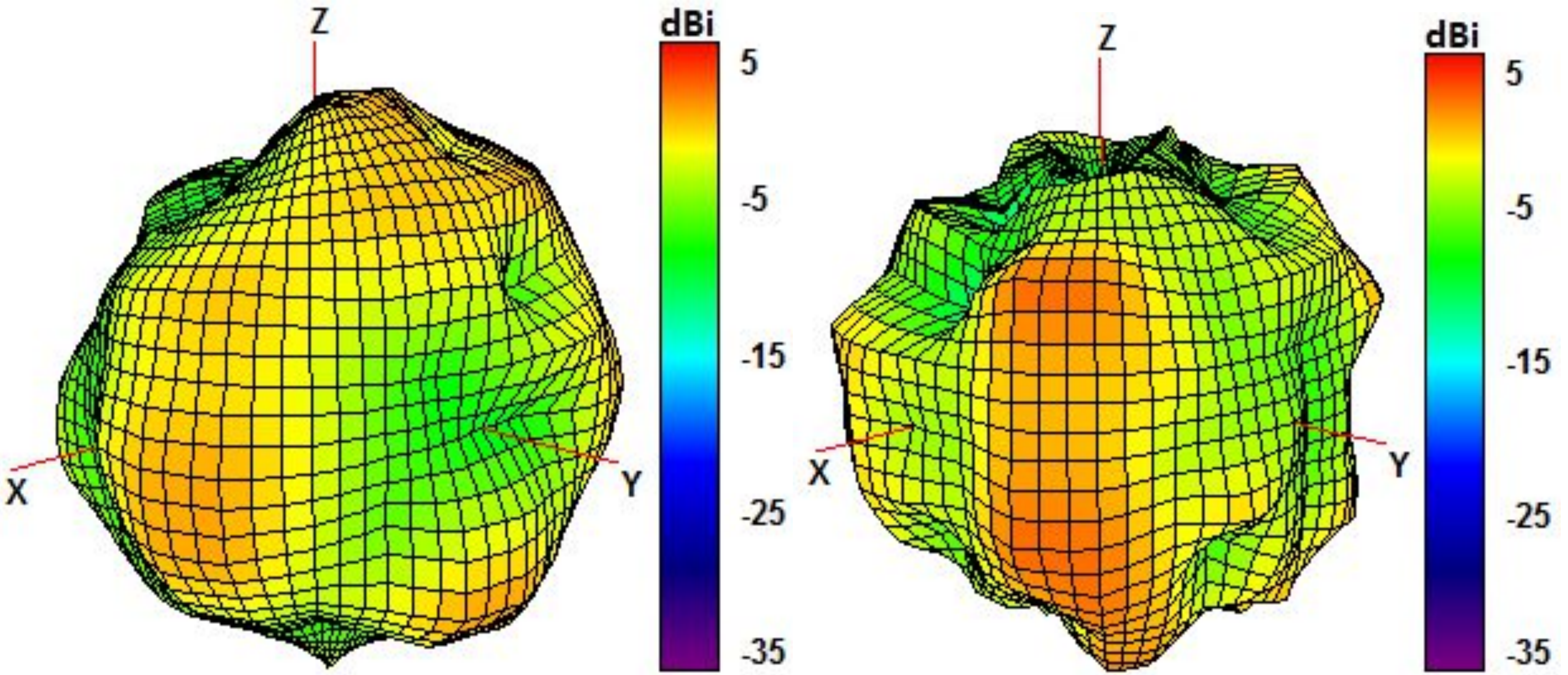

940 and 1750 MHz Radiation pattern

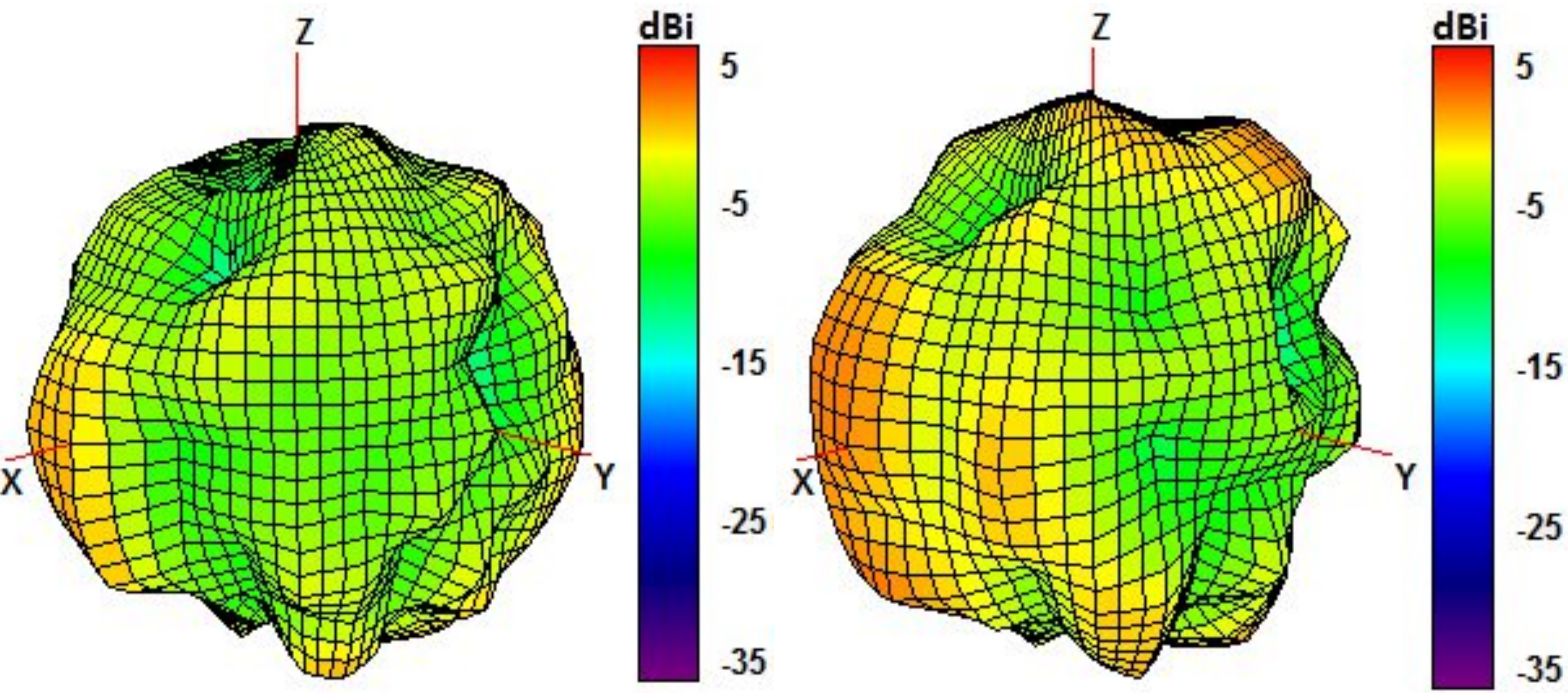

1850 and 1950 MHz Radiation pattern

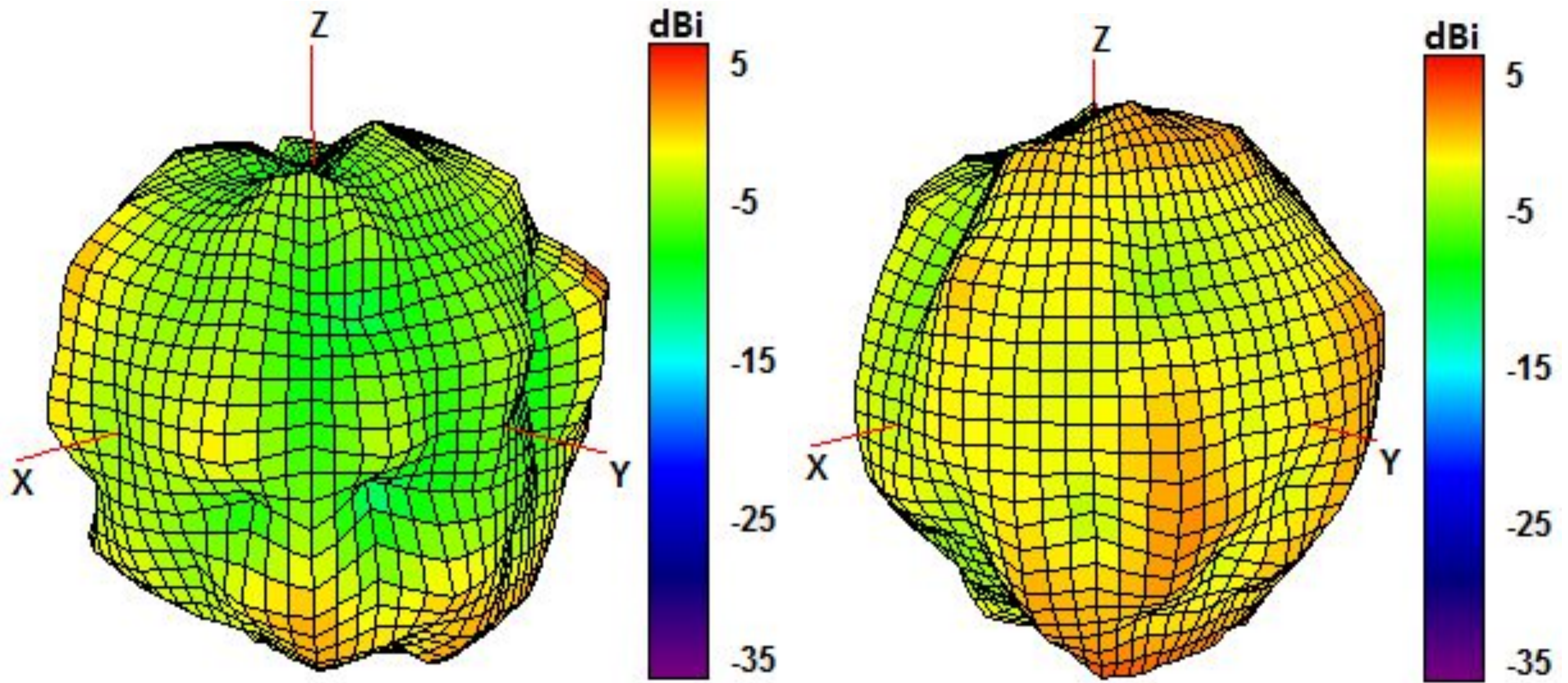

2100 and 2600 MHz Radiation pattern

Cable 3: 2.4/5.0 GHz ISM

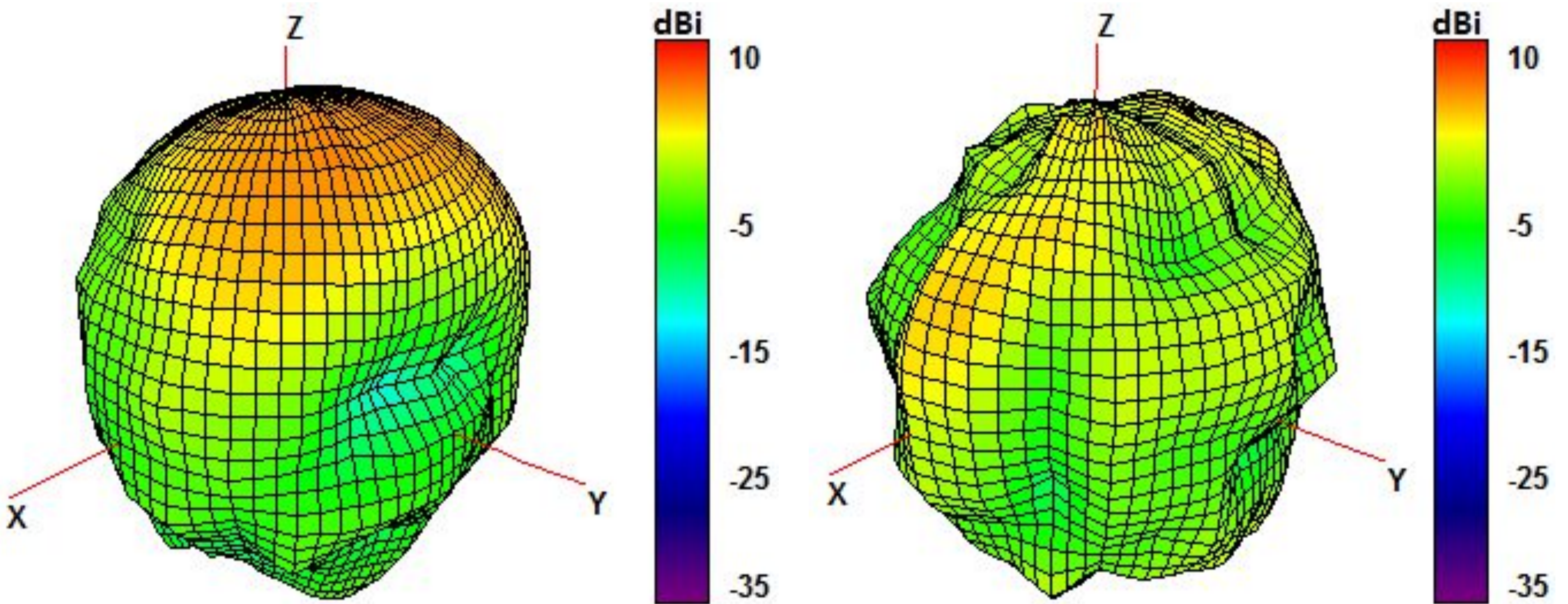

2450 and 5500 MHz Radiation pattern

Cable 4: 2.4/5.0 GHz ISM

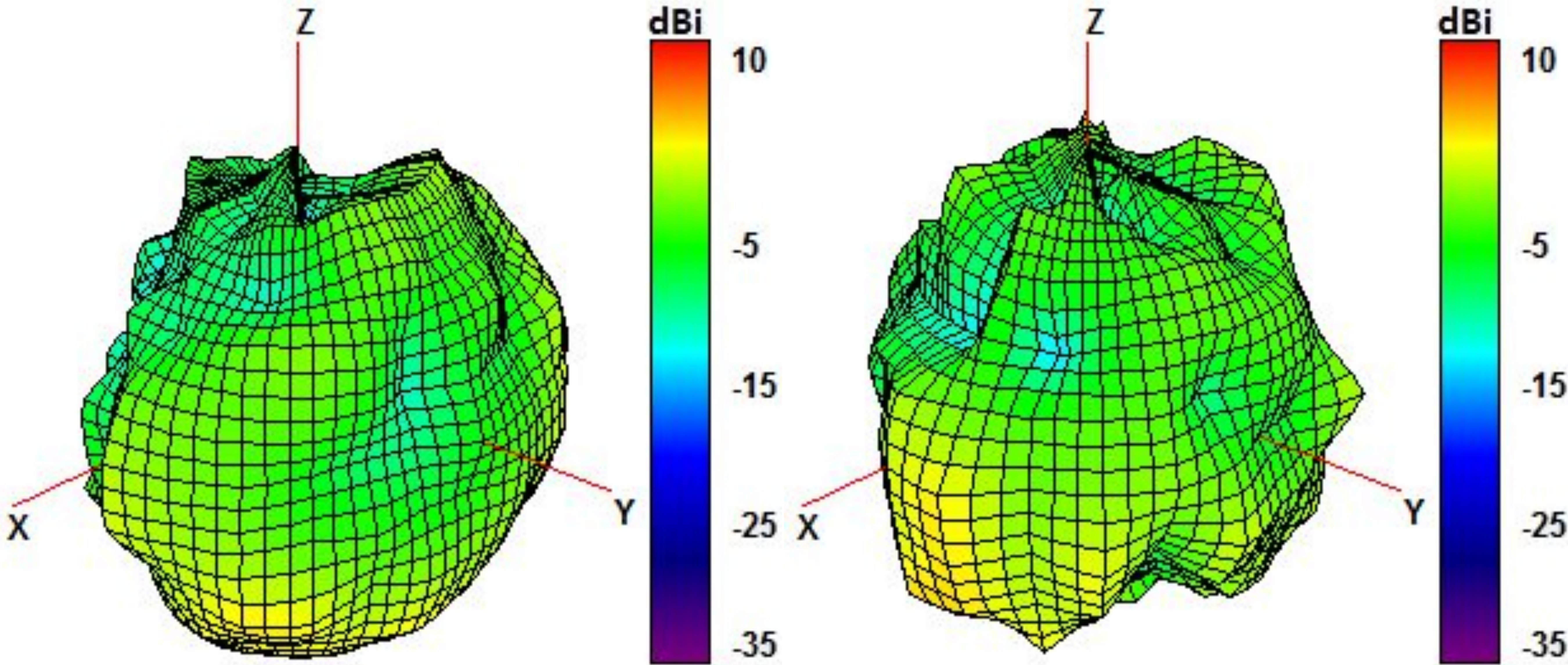

2450 and 5500 MHz Radiation pattern

5. Antenna drawings

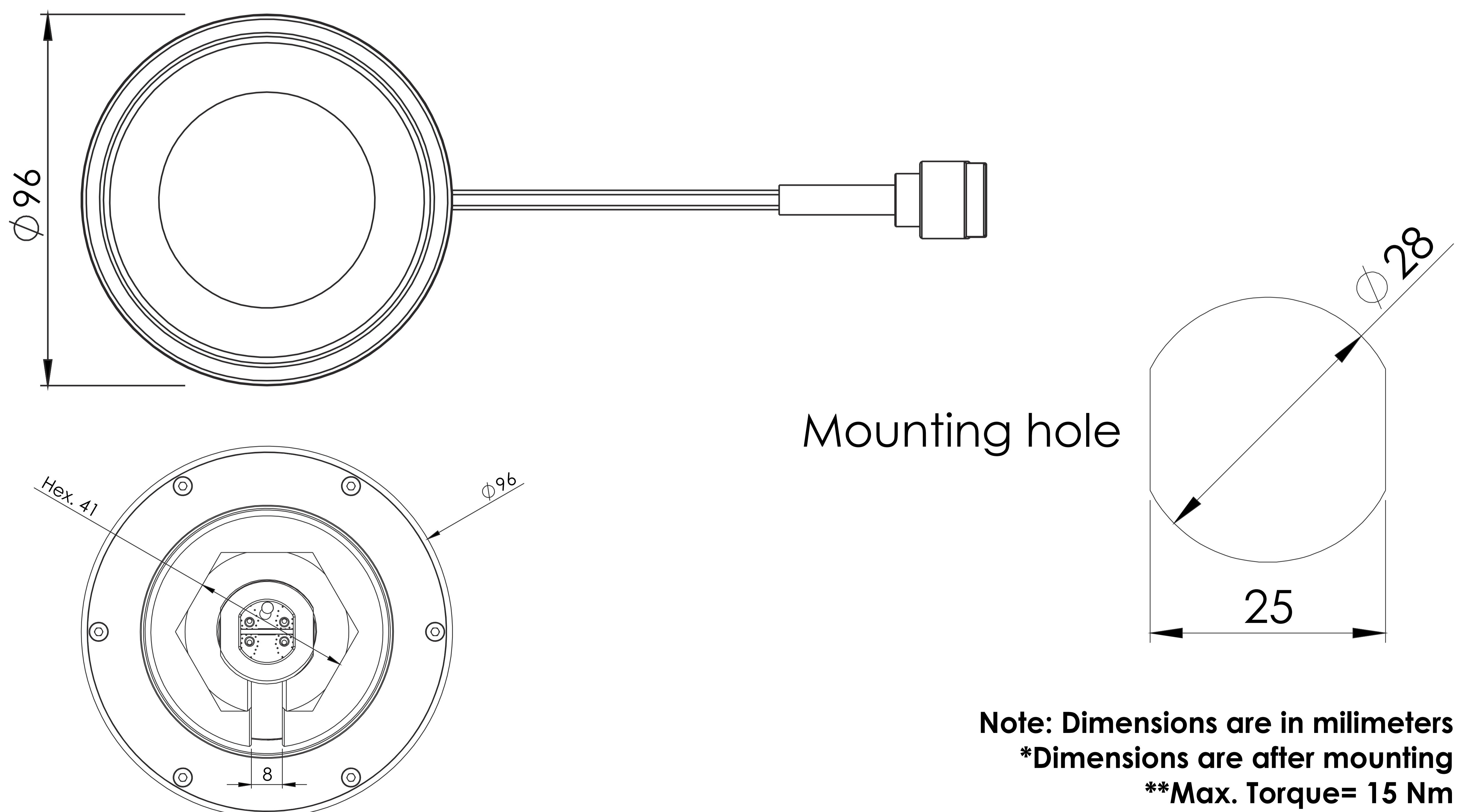
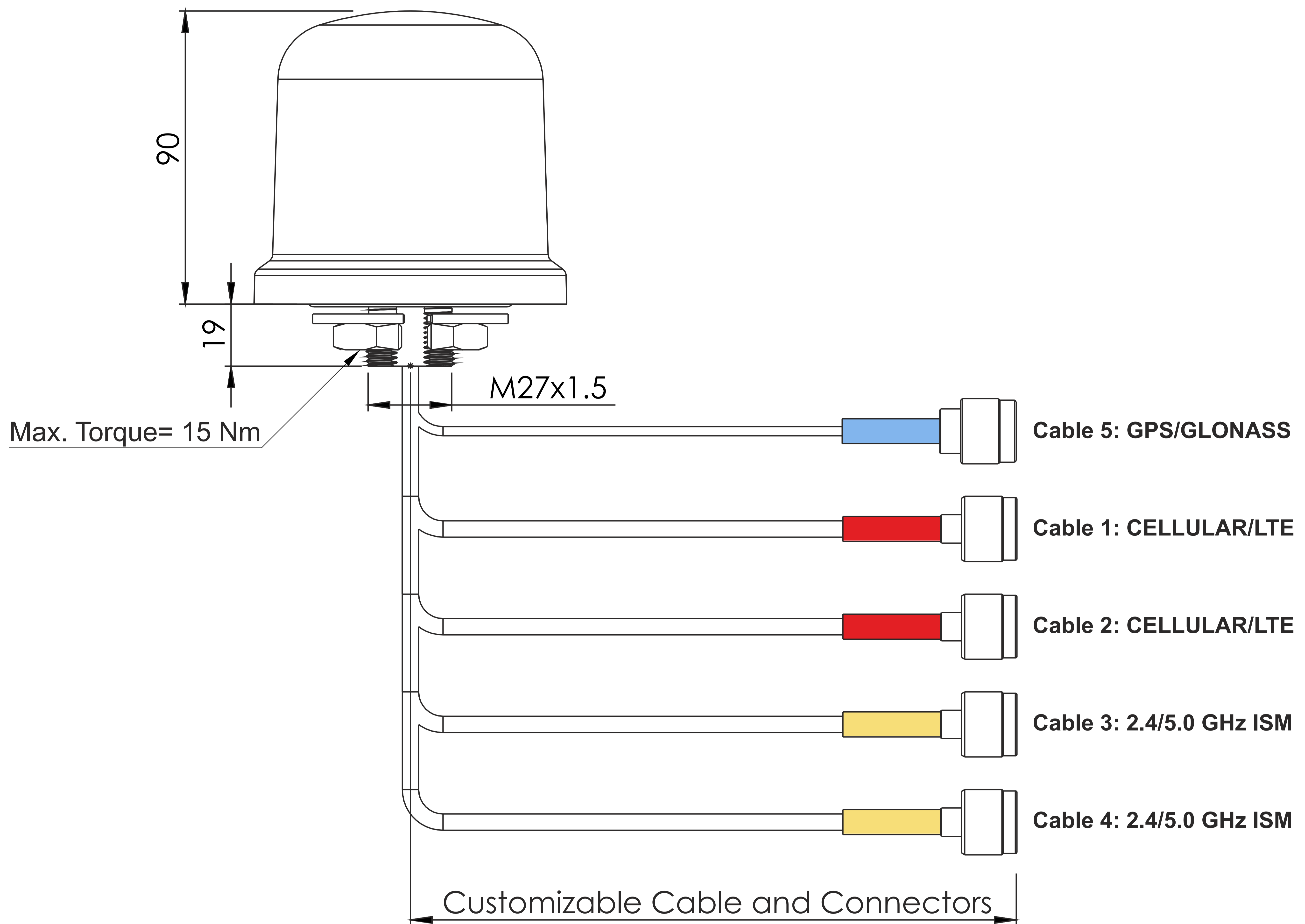

6. Jumper cables drawings - Optional

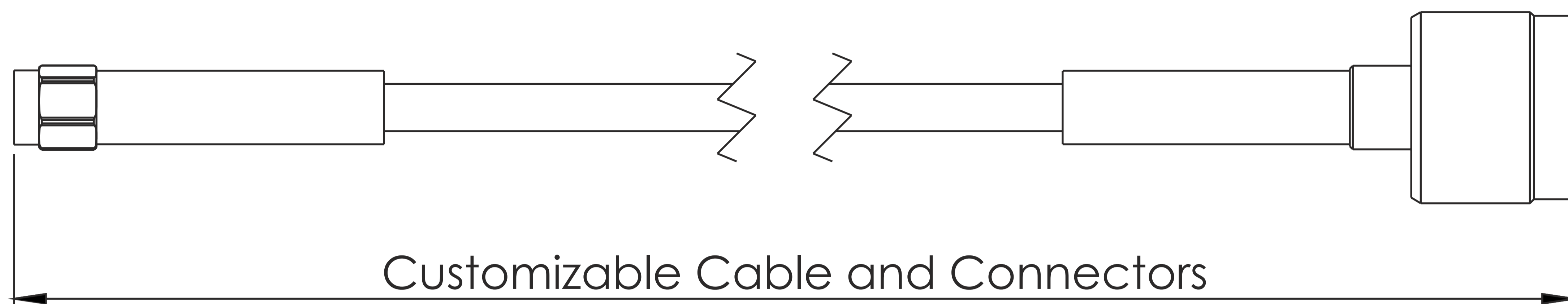

C318N-LMR195-C91N OST - 2x

Cable 1 and 2: CELLULAR/LTE - Shrink tube Orange d6,4

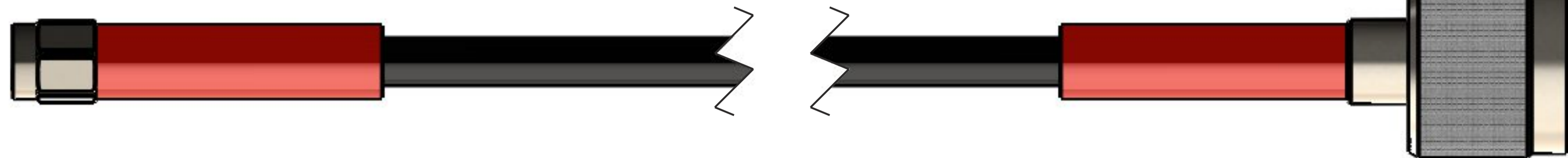

C318N-LMR195-C91N BST

Cable 5: GPS/GLONASS - Shrink tube Light blue d6,4

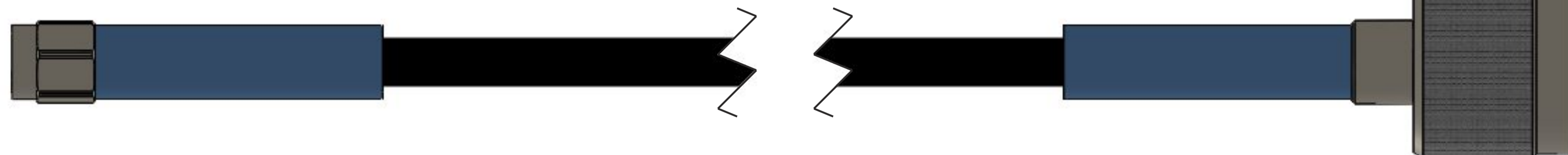

C318N-LMR195-C151N GST - 2x

Cable 3 and 4: 2.4/5.0 GHz ISM - Shrink tube yellow d6,4

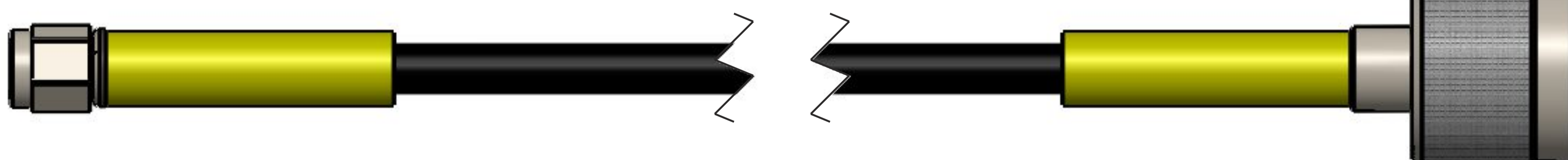

7. Antenna Images

