

TOWER KITS INSTRUCTION



Contents

Overview	2
1. Safety precautions	3
2. Open the case for inspection	4
3. The assembly drawing	4
4. Component list	5
5. Install and remove tools	6
6. Installation steps	7
7. Method of use	8
8. Specification for keg and cylinder system modelconfiguration	10
9. Cleaning method	11
10. Packing details	15
11. Product selection	19

OVERVIEW

This manual is an important part of product, is an indispensable part, please keep properly.

The notes recorded in this manual are very important information, please read it carefully, use and clean it correctly, any use beyond the specified use is considered improper and dangerous.

The manufacturer will not accept any loss caused by improper installation or improper use the company has no responsibility

In order to provide better service to customers, TALOS will continue to develop more products, and continue to optimize and improve product quality, may improve the appearance and parts details, etc. If there is any difference, forgive us without prior notice and without any obligation or liability.

If you have any questions, please contact American Talos Inc

Toll-free hotline :(626) 923-9266

1. SAFETY PRECAUTIONS

- ⊙ Be sure to wear safety glasses and gloves when handling chemicals
- ⊙ Cylinders should be stored in a cool, dry, away from heat sources (such as sunlight, heat, fire), not more than 70°F, so as not to increase the temperature of the liquid CO₂, volume expansion and the formation of high-pressure gas, resulting in explosion risk
- ⊙ Gas cylinders are not allowed to lie down. If the cylinder is lying down and the regulator is opened, the CO₂ liquid is rapidly vaporized. It is easy to happen the accident of gas line burst and a lot of leakage of CO₂
- ⊙ It is forbidden to move and knock gas cylinders at will. When allowed to move, it should be done to move and put gently. After installation, gas cylinders are not allowed there may be a drop collision
- ⊙ Make sure that the cylinders will not fall or collide after installation
- ⊙ If the CO₂ leaks, headaches and breathing difficulties occur, the CO₂ content in the room can be high. Please air the area immediately and leave the room.







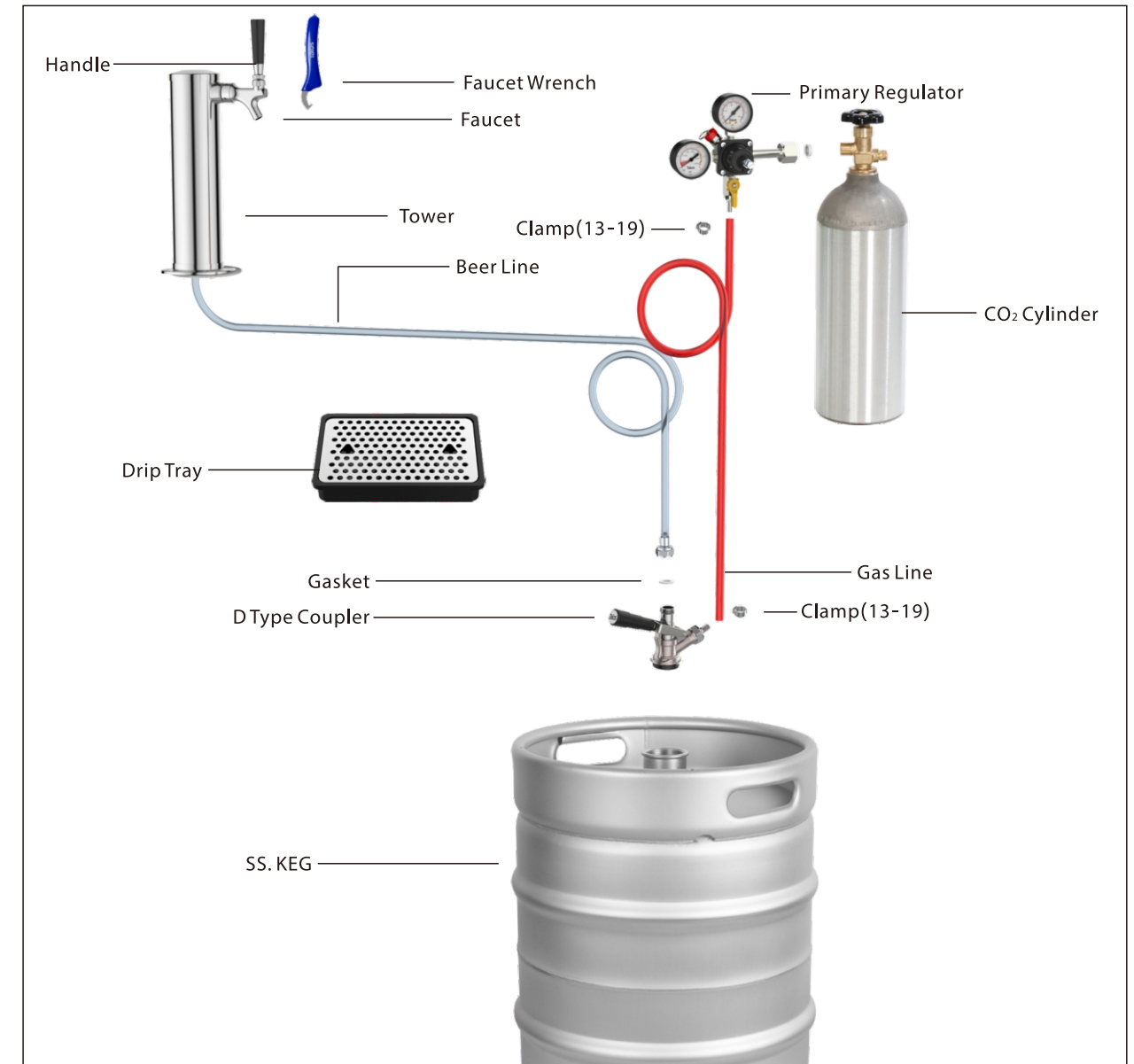







2. OPEN THE CASE FOR INSPECTION

- ⊙ Check whether the outer packing is intact, if there is serious damage to refuse or contact customer service;
- ⊙ Cut open the sealing tape on the carton with the cutter, please pay attention not to scratch the product surface when cutting;
- ⊙ Check whether the product is in good condition. If the appearance of the product is damaged during transportation, please contact the customer take care of;
- ⊙ Take out the products in the box in turn, count the number of products according to the list of components, if there is a shortage.

3. THE ASSEMBLY DRAWING



4. COMPONENT LIST

Item No.	Image	Description	Qty	Remark
1		Faucet	1 or 2	Necessary, according to the number of the selection 1 tap come with 1, 2 taps with 2
2		Coupler	1 or 2	Necessary, according to the number of the selection 1 tap come with 1, 2 taps with 2
3		Drip Tray	1	Necessary
4		Wrench	1	Necessary
5		Gas Line	1 or 2	Necessary, Gas line's length base on the number of tower, 1 way come with 1 (5"/Line), 2 ways with 2
6		Beer line	1 or 2	Necessary, Gas line's length base on the number of tower, 1 way come with 1 (5"/Line), 2 ways with 2
7		5 Lbs Cylinder	1	Necessary
8		Clamp(13-19)	4 or 8	Necessary, Quantity base on the number of tower, 1 way come with 4 pieces, 2 ways with 8 pieces
9		Primary Regulator one way	1	Necessary, optional base on the number of tower, 1 way come with 1 barb, 2 ways with 2 barbs
		Primary Regulator two way		
10		One way tower	1	Base on your option
		Two way tower	1	
11		Manul cleaning pump	1	Optional
12		Cleaning liquid	1	Optional

5. INSTALL AND REMOVE TOOLS

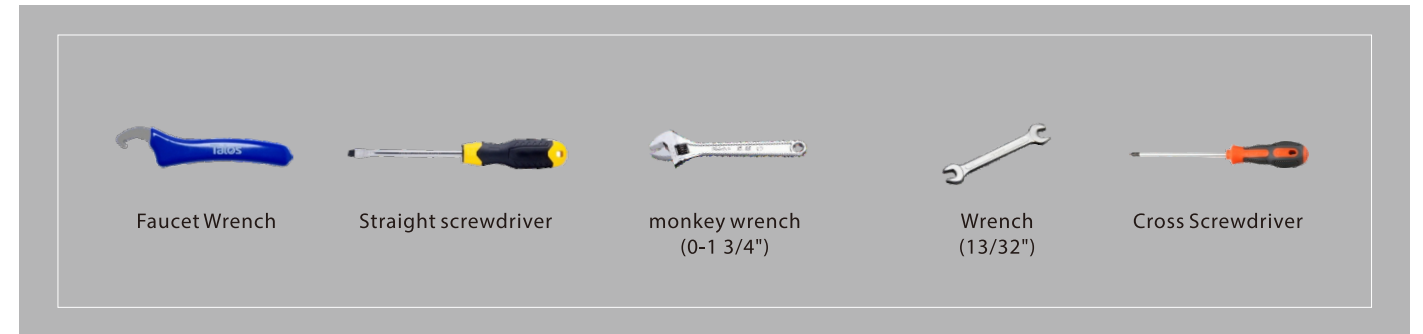

6. INSTALLATION STEPS

1 Beer column installation: ①Put the hose on the column into the beer machine flat on the orifice of the plane; ②The four holes of the black gasket and the column alignment of four holes in the upper flange; ③With the four kegerator align the holes and put them in place.

2 Beer column installation: ①Take out the screws in the column accessory package, respectively place into the four holes in the stem flange (head up). ②Take out the nut and gasket of the accessory package and match them to the top screw of the machine on, twist in place by hand (position as shown below).

3 Beer column installation: with a wrench on the hexagon nut, and then use ten the screwdriver is tightened on the cross screw.

4 Faucet installation: the first faucet and column on the connection of the teeth of the pipe (make sure the faucet outlet is facing down), and tighten the four-hole nut. Finally tighten with a faucet wrench

5 Coupler joint installation: match the joint to the coupler tighten the needle with a monkey wrench

6 Coupler pipeline connection: (1) put adjustable clamp on the gas pipe, at the same time to the joint, and then use a screwdriver to tighten (joint slotted position) the other end of the beer column out of the nut directly to the part metering probe

7 Regulator line connection: the coupler out of the other end of the pipe fit the clamp on the small ball valve of the regulator(gas outlet), tighten with a screwdriver (joint with slot position)

8 Cylinder installation: connect the matched regulator to the cylinder and use tighten the adjustable wrench and dial the regulator to the person

9 Connect the coupler to the keg: align with the lugs on the keg at the bottom of the coupler and rotate clockwise in place

7. METHOD OF USE

7.1 TAPPING OPERATION METHOD

- 1) open the cylinder valve (rotate counterclockwise).
- 2) use a word screwdriver to turn the screw clockwise slowly rotate the direction to set the output pressure of the regulator, conventional beer set at 30~40 PSI, others not the same variety of beer according to the requirements set different pressure;
- 3) rotate the small ball valve to the "open" position;
- 4) while serving, pull out the coupler handle and press down, Until it clicks.

2 Adjust the pressure 30~40PSI

1 Open

3 Turn off

4 Pull out the handle and press down until it is tight

7.2 OPERATION METHOD OF REPLACING GAS CYLINDER

1. Remove the gas cylinder;

- 1) turn "A" clockwise to close the cylinder valve;
- 2) close ball valve "B";
- 3) remove the nut at "C" of the regulator and remove the gas cylinder.

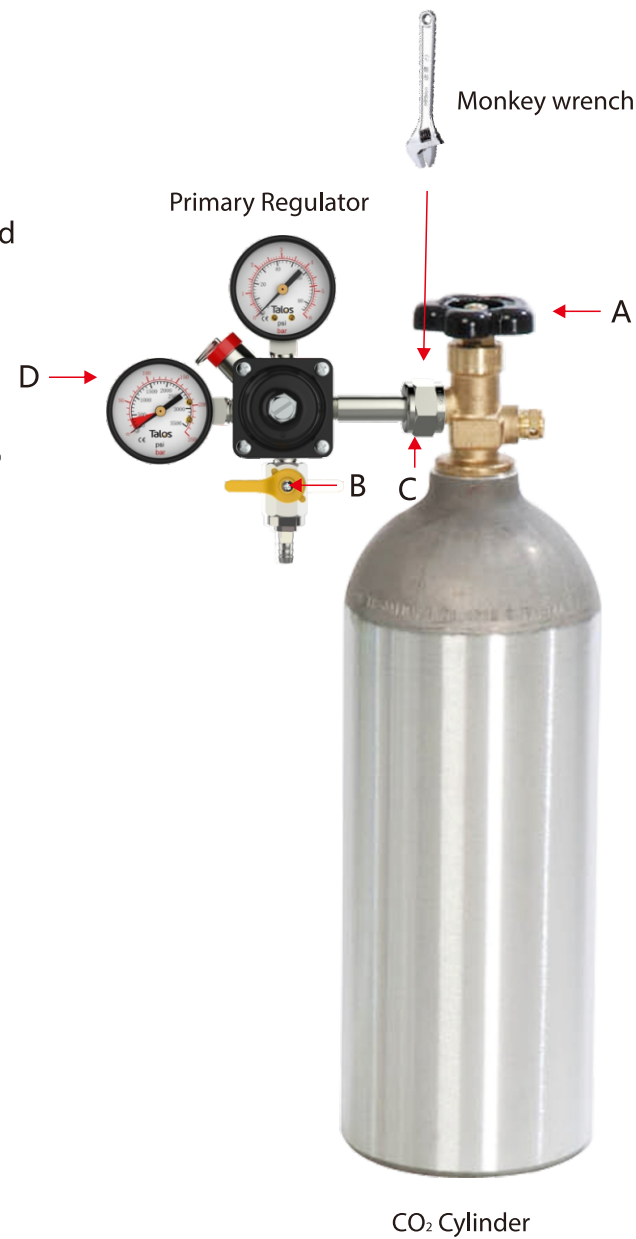

2. Reload gas cylinders

- 1) directly screw the nut on the regulator to the new air; On the bottle (check the nut for washer before installation);
- 2) close "B";
- 3) open valve "A";
- 4) check the air pressure "D" to see if the air pressure is sufficient.

8. SPECIFICATION FOR KEG AND CYLINDER SYSTEM MODEL CONFIGURATION

Selection of kegs and cylinders: kegs and cylinders can be placed upright in the refrigerator (see the keg specification table), Keep it at least 8 inches from the top of the refrigerator.



Specification of keg and cylinder

Name	Keg				Cylinder				
Model	1/2 Barrel	1/14 Barrel	1/4 Slim	1/6 Keg	20 LBS	15 LBS	10 LBS	5 LBS	2.5 LBS
Height	23.3"	14.8"	23.3"	23.3"	23 3/16"	23 1/8"	16 1/2"	14 3/16"	10 5/16"
Dimeter	17"	17"	11"	9.25"	8"	6 7/8"	6 7/8"	5 1/4"	4 3/8"
Capacity	15.5 Gal.	7.75	7.75	5.23	29.40	22.10	14.70	7.40	3.70

9. CLEANING METHOD

Cleaning tool



water



bucket



glove



safety goggle

9.1 REMOVE ACCESSORIES

- 1. Close the gas cylinder:** close the gas cylinder clockwise (as shown in figure 1) and close it close regulator's valve;
- 2. Splitter:**
 - 1) hold the coupler and screw it out counterclockwise (as shown in the serial number)
 - 2) use a monkey wrench to separate the nut from the beer line in a counterclockwise direction screw out the inlet nut on the adapter. (keep the seals and one-way silicon (3) glue, as shown in FIG. 1);
 - 3) use a screwdriver to screw out the cross screw in a counterclockwise direction here, pull out the handle, pull the probe up (as shown in FIG. 2, the two o-rings on the body are in the correct position.
- 3. Remove tap:**
 - 1) place the faucet wrench on the four-hole nut of the panel, turn the tap out in a clockwise direction (see figure 1, keep the seal on the tap);
 - 2) first screw out the plastic handle, then screw out the upper nut in half.Screw the nut out counterclockwise and pull the handle out (keep the ball bearing), and finally move the piston out (make sure the seal is in the correct position.

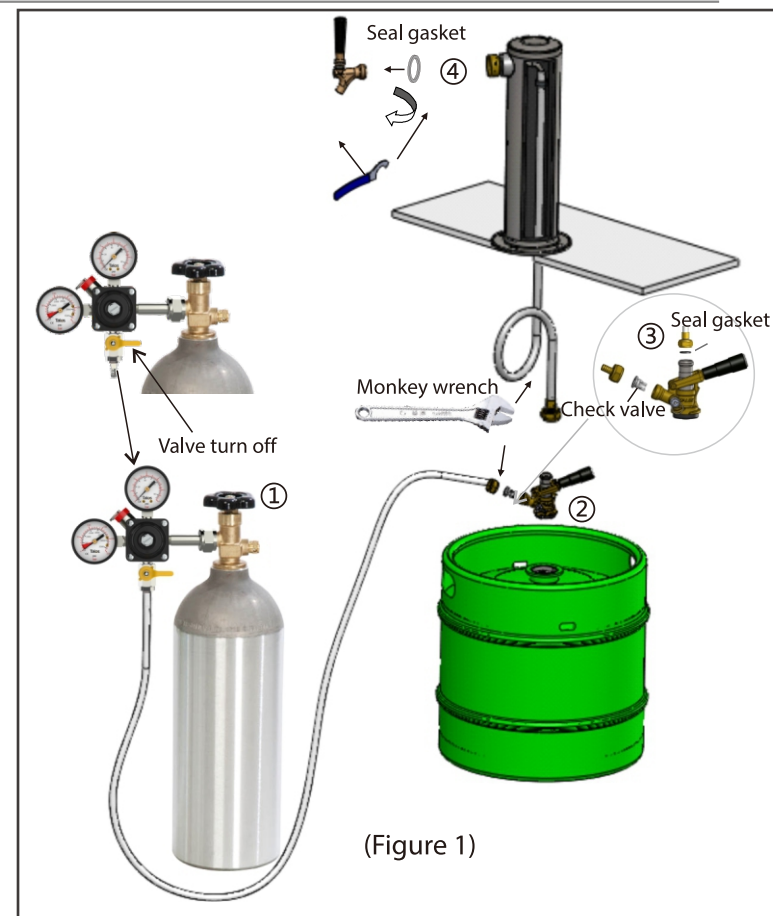

(Figure 1)

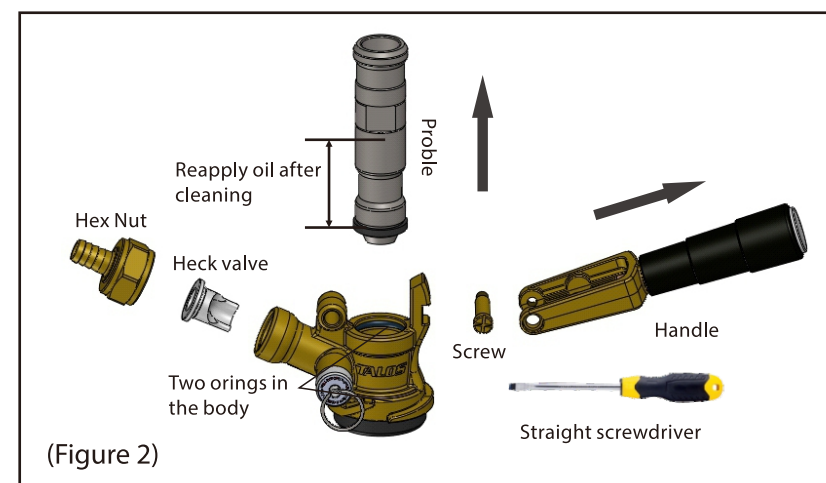

(Figure 2)

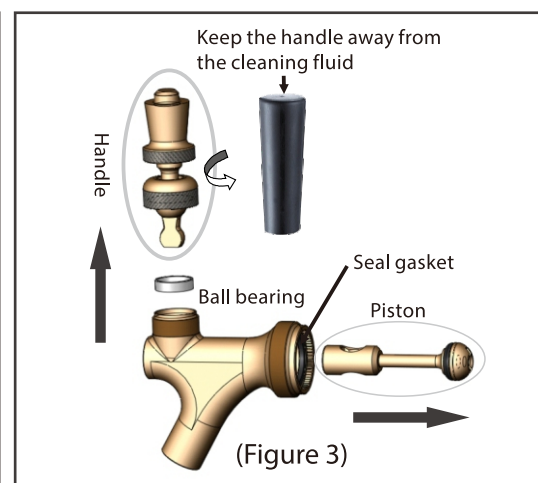

(Figure 3)

9.2 CLEANING ACCESSORIES (AS SHOWN IN THE RIGHT PICTURE)

- 1. Configure the cleaning liquid:** according to the cleaning liquid manual after matching, pour into the cleaning bottle and bucket (such as serial number ①);
- 2. Cleaning faucet and dispenser:** place in the bucket and remove the dispenser instruments and faucet parts, soak after ten minutes (plastic do not soak the handle) rinse with clean water and brush the inner hole to clean (serial numbers ② and ③);
- 3. Pipeline cleaning:**
 - 1) First place 4 sponge balls into the cold storage of the faucet connection position the box is connected to the inner hole, and then the gasket in the accessory package is put in the clean wash the connection of the pump and connect to the cooler connection (e.g serial number④, tap removal position);
 - 2) Lift up the outlet joint at pipe A (above connect the faucet B), repeatedly press the cleaning pump, clean the liquid through the pressure input pipe drives the sponge ball in the liquor pipe medium cleaning, the cleaning fluid to stay in the pipeline 5-10 minutes clock around, so that the dirty pipe and cleaning fluid up chemical reaction, and then put the beer line A joint go into the bucket and rinse repeatedly until there is no stain (as the serial number⑤);
- 4. Rinse:**
 - 1) Unscrew the lid of the cleaning bottle and rinse the bottle thoroughly and refill with clear water (such as serial number ⑥);
 - 2) Press the cleaning pump several times and run cold water through the beer line the cleaning fluid rushes into the bucket. Rinse repeatedly for more than 3 times. Then disconnect the connection between the cleaning pump and the refrigerator (such as serial number ⑦).

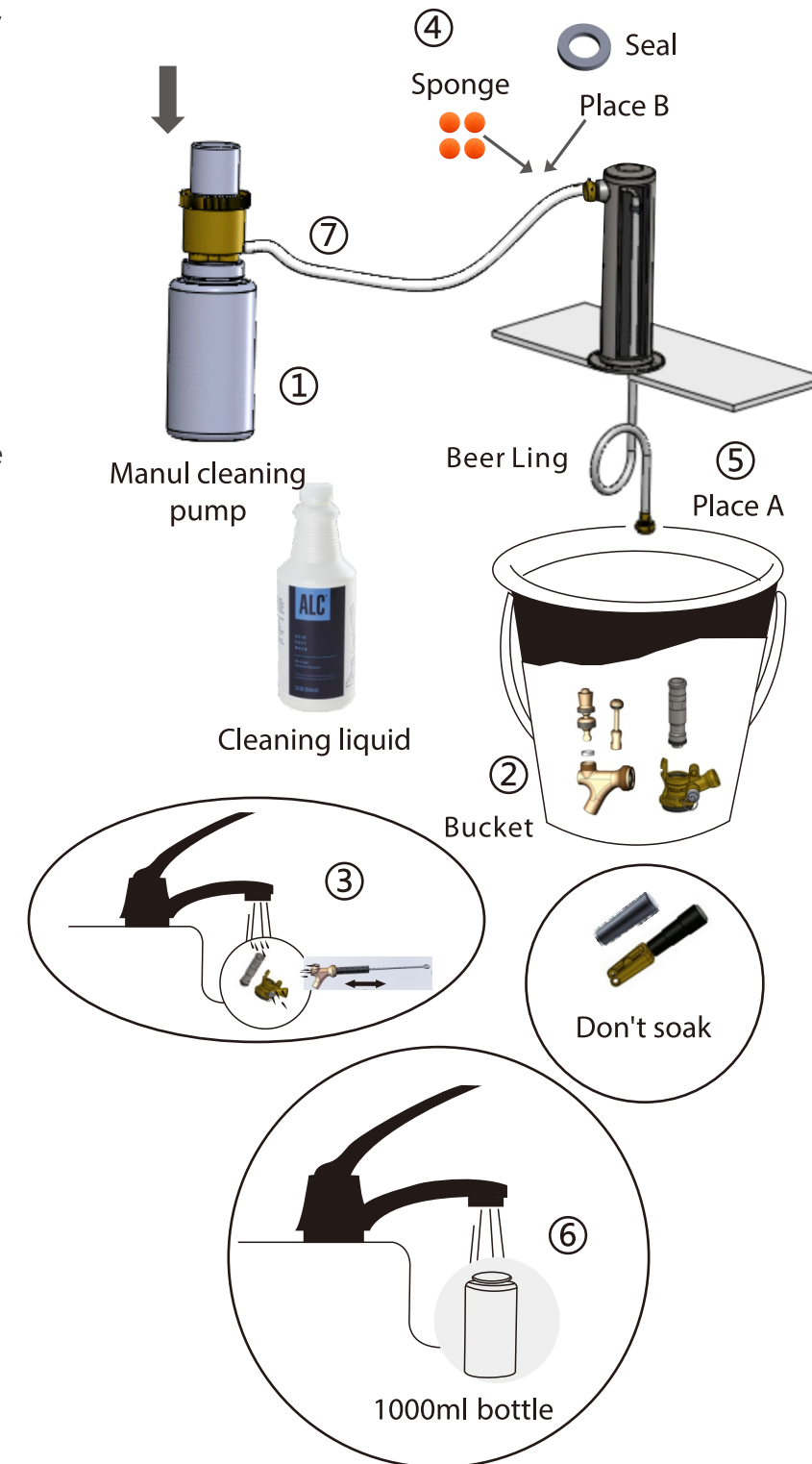

9.3 ASSEMBLY FAUCET

1. **Check the faucet seal:** check the pad on the faucet piston after cleaning are the washers on the ring and handle rods in good condition (figure 1)

2. **Faucet assembly:**

- 1) insert the piston into the inner hole of the valve body in the direction shown in FIG. 2 (note the flat side facing up);
- 2) put the ball bearing into the handle hole of the valve body (note R Angle is up), then small handle into the valve body, and then tighten the nut, and when appropriate tighten the nut with the needle and finally attach the plastic handle to the handle rod (e.g Figure 2).

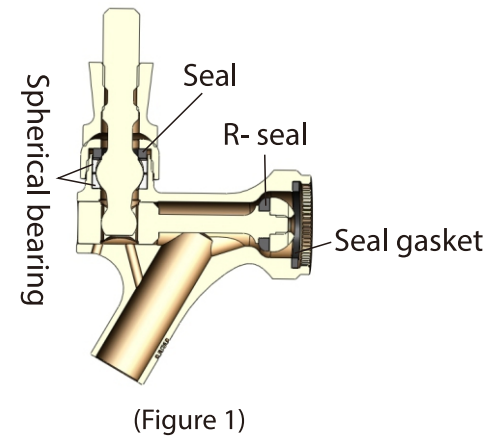

9.4 ASSEMBLE THE COUPLER

1. **Check coupler seals:** after cleaning, check two on the valve body are the o-rings, seals and gaskets on the bottom of the probe in place in good condition;

2. **Coupler assembly:**

- 1) coat the cleaned probe with oil (see FIG. 3, Note: flat side to relief valve position) to enable coupler probe enough to move freely;
- 2) load the probe vertically into the inner hole of the valve body as shown in FIG. 3;
- 3) install the handle to align the probe in place hand hole to pressure relief valve position), then insert the screw, and use a screw knife tight;
- 4) install one-way silica gel into the inlet of the valve body, and then use the inlet nut to tighten the needle.

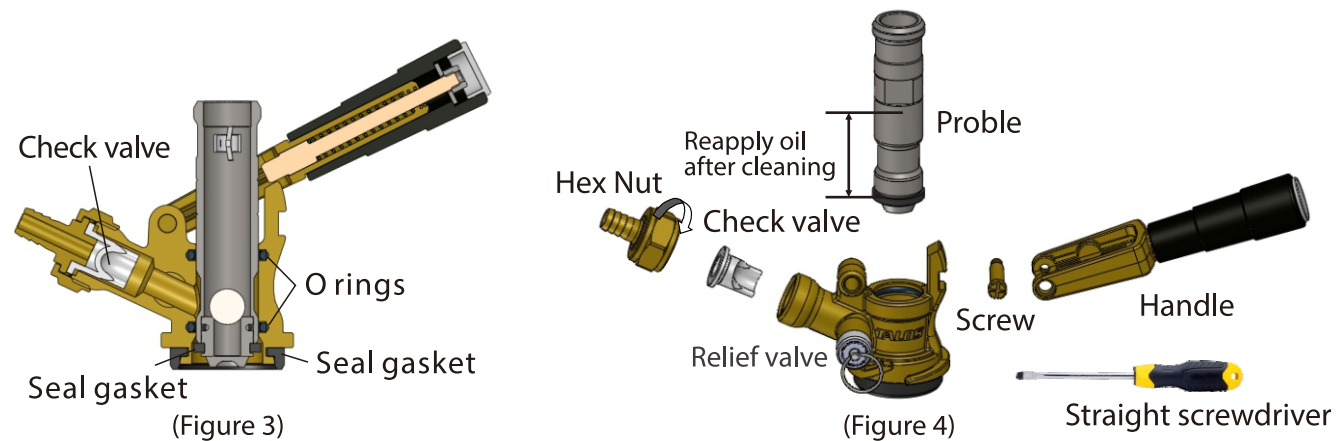
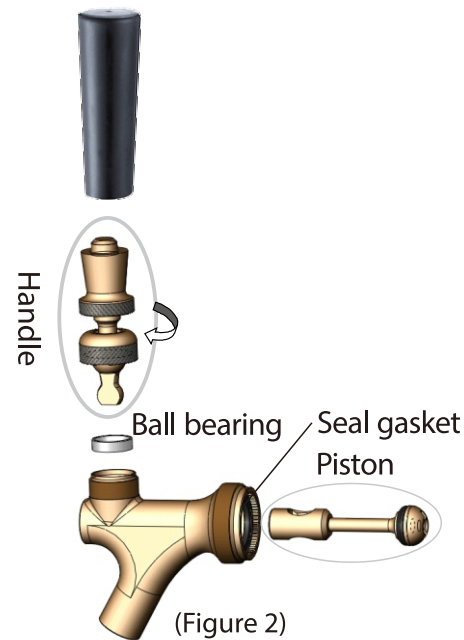

9.5 REINSTALL ACCESSORIES

1. **Install the faucet:** put the matched faucet on the connecting hose of the refrigerator and use a wrench to reverse the time tighten the four-hole nut (e.g. serial number)

2. **Install coupler:**

- 1) match the beer line to the coupler and tighten it by hand to remove the relevant accessories of the intake hose to the coupler, and then with a monkey wrench to tighten (such as the number to ensure that install upper gasket and one-way silica gel);
- 2) install the coupler clockwise on the keg

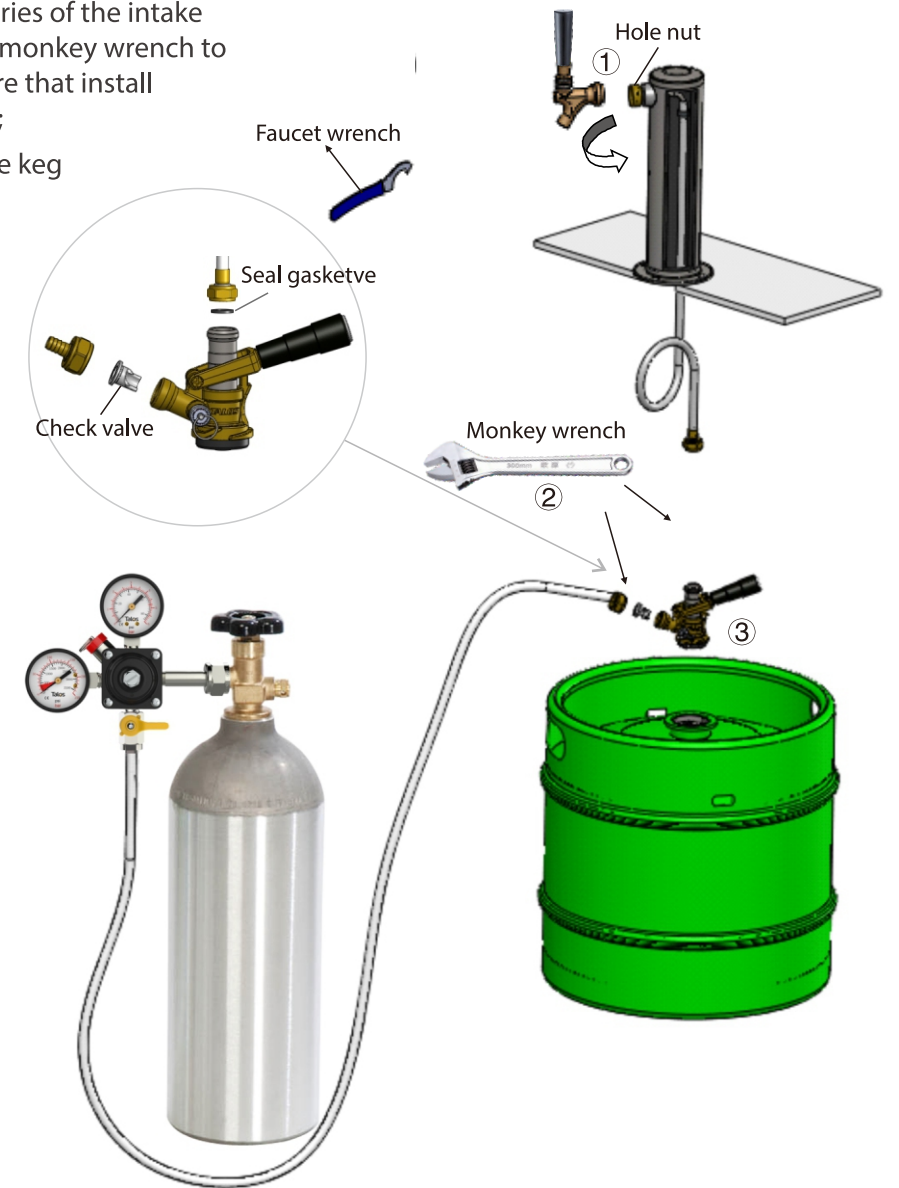

10.PACKING DETAIL

Optional 1

Handle — Faucet Wrench
Faucet
Tower
Beer line
Drip Tray
Primary Regulator
Cylinder
Clamp(13-19)
Gas Line
Gasket
D Type Coupler

Name	Qty
Products	1
Instruction	1
Certification	1

Graphic Description

Optional 2

Handle — Faucet Wrench
Faucet
Tower
Beer line
Drip Tray
Primary Regulator
Cylinder
Gas Line
Clamp(13-19)
Gasket
D Type Coupler
Manul Cleaning Pump
Cleaning liquid
Brush

Name	Qty
Products	1
Instruction	1
Certification	1

Graphic Description

Optional 3

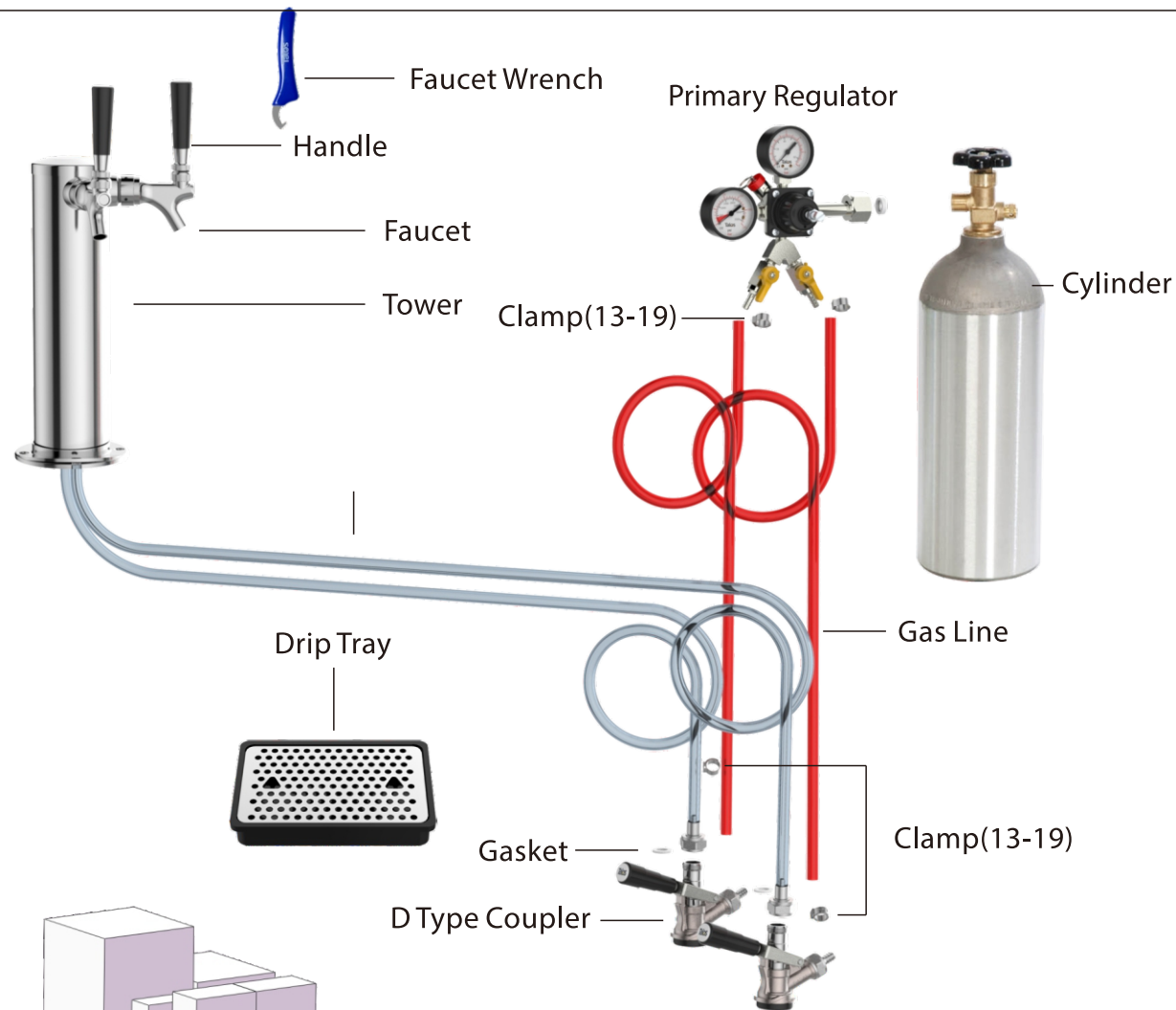

Graphic Description

Name	Qty
Products	1
Instruction	1
Certification	1

Optional 4

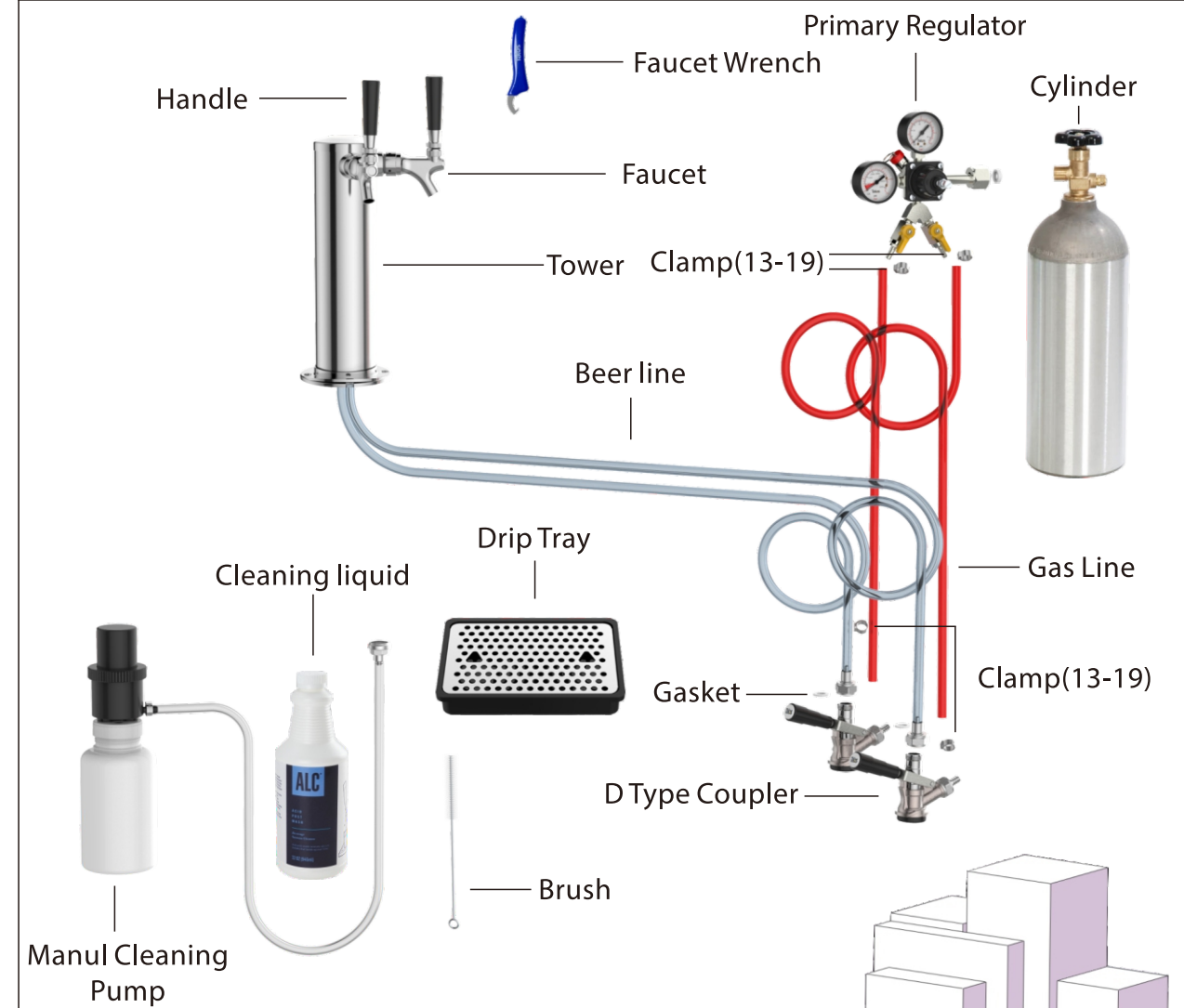

Graphic Description

Name	Qty
Products	1
Instruction	1
Certification	1

11.PRODUCTION SELECTION

(1) Faucet



Model: 1011001
Material: Brass
Thread: 1-1/8-18unef



Model: 1011302
Material: 304 S.S
Thread: 1-1/8-18UNEF



Model: 1012622
Material: 304 S.S
Thread: 1-1/8-18UNEF



Model: 1013001
Material: 304 S.S
Thread: 1-1/8-18UNEF

(2) Handle



1011009-02



1011004-08



1011009-01



1011004-01

(3) Tower



Model: 1042160 / 1042108
Material: 304 S.S
Beer line: 304 S.S (5/16" O.D)
Hose:(7/16")O.Dx(3/16")I.D
Connection: 1/4" O.D / G 5/8



Model: 1042260 / 1042208
Material: 304 S.S
Beer line: 304 S.S (5/16" O.D)
Hose:(7/16")O.Dx(3/16")I.D
Connection: 1/4" O.D / G 5/8



Model: 1042360 / 1042305
Material: 304 S.S
Beer line: 304 S.S (5/16" O.D)
Hose:(7/16")O.Dx(3/16")I.D
Connection: 1/4" O.D / G 5/8

(4) Coupler



Model: D type 1022709
Baody Material: Brass
Probe: Brass
Thread: G 5/8



Model: D type 1022709
Baody Material: Brass
Probe: 304 S.S
Thread: G 5/8



Model: D type 1022720
Baody Material: 304 S.S
Probe: 304 S.S
Thread: G 5/8



Model: D type 1022719
Baody Material: Brass
Probe: Brass
Thread: gas in ϕ 10, beer out ϕ 6.5



Model: S type 1025709
Baody Material: Brass
Probe: Brass
Thread: G 5/8



Model: S type 1025709
Baody Material: Brass
Probe: 304 S.S
Thread: G 5/8



Model: S type 1025720
Baody Material: 304 S.S
Probe: 304 S.S
Thread: G 5/8



Model: A type 1021710
Baody Material: Brass
Probe: 304 S.S
Thread: G 5/8



Model: M type 1024701
Baody Material: Brass
Probe: 304 S.S
Thread: G 5/8



Model: G type 1023701
Baody Material: Brass
Probe: 304 S.S
Thread: G 5/8



Model: F type 1027701
Baody Material: Brass
Probe: 304 S.S
Thread: G 5/8



Model: U type 1026701
Baody Material: Brass
Probe: Brass
Thread: G 5/8

World standard keg match with Talos coupler

Type	D type	S type	M type	A type	G type	F type	U type
World standard keg type							
Talos coupler	 Model: 1022704	 Model: 1025704	 Model: 1024701	 Model: 1021701	 Model: 1023701	 Model: 1027701	 Model: 1026701

(5) Coupler components



Model: 1113127
Name: SS. MINI BALL VALVE

Model: 1111006
Name: SS.Adapter

Model: 1111005
Name: Probe and o-ring lubricant

(6) Soda fitting



Model: 1118101
Name: Gas in ball lock fitting



Model: 1118105
Name: Liquid out ball lock fitting

(7) Cleaning chemical



Model: 1112015
Name: Blc alkaline liquid cleaner



Model: 1112016
Name: Alc acid liquid cleaner



Model: 1112018
Name: Powder 16 oz tub



Model: 1112017
Name: Powder 40 lb bulk

Horizontal lines for notes or additional information.