

WINIX

User Manual

AIR PURIFIER

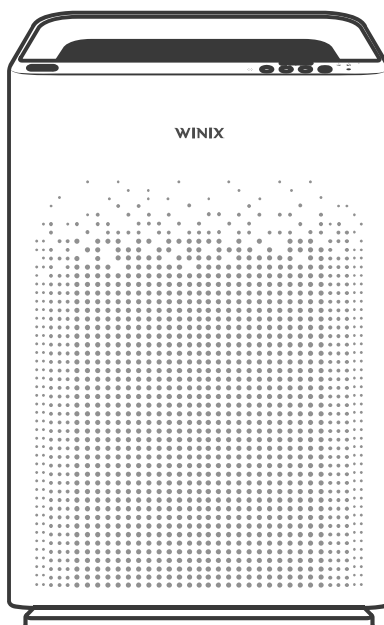

Model: Zero S (AZSU350-JWE)

EN AIR PURIFIER	User Manual	CZ ČISTIČKA VZDUCHU	Uživatelská příručka
FR PURIFICATEUR D'AIR	Manuel d'utilisation	SK ČISTIČKA VZDUCHU	Používateľská príručka
ES PURIFICADOR DE AIRE	Manual del usuario	TR HAVA TEMİZLEYİCİ	Kullanım Kılavuzu
DE LUFTREINIGER	Bedienungshandbuch	SV LUFTRENARE	Bruksanvisning
IT PURIFICATORE D'ARIA	Manuale d'uso	DA LUFTRENSER	Brugermanual
NL LUCHTREINIGER	Gebruikershandleiding	NO LUFTRENSER	Brukerhåndbok
PL OCZYSZCZACZ POWIETRZA	Instrukcja obsługi	RU ОЧИСТИТЕЛЬ ВОЗДУХА	Руководство пользователя

CONTENTS

English	4
Français	14
Español	24
Deutsche	34
Italiano	44
Nederlands	54
Polski	64
Čeština	74
Slovenčina	84
Türkçe	94
Svenska	104
Dansk	114
Norsk	124
Русский	134

EN	Use & Care Guide	<ul style="list-style-type: none"> • The product warranty is printed on the back of this guide. • This product is suitable for AC 220 V - 240 V only.
FR	Manuel d'entretien et d'utilisation	<ul style="list-style-type: none"> • La garantie du produit est imprimée au dos de ce guide. • Ce produit fonctionne uniquement avec CA 220 V - 240 V.
ES	Guía de uso y cuidado	<ul style="list-style-type: none"> • La garantía del producto está impresa al final de esta guía. • Este producto solo es adecuado para suministros de 220 V - 240 V.
DE	Bedienungs- und Pflegehandbuch	<ul style="list-style-type: none"> • Die Produktgarantie ist auf der Rückseite dieses Handbuchs abgedruckt. • Dieses Produkt ist nur für AC 220 V - 240 V geeignet.
IT	Manuale d'uso e manutenzione	<ul style="list-style-type: none"> • La garanzia del prodotto è stampata sul retro di questa guida. • Questo prodotto funziona solo a CA 220 V - 240 V.
NL	Gebruik- en onderhoud Gids	<ul style="list-style-type: none"> • De productgarantie staat afgedrukt op de achterkant van deze gids. • Dit product is uitsluitend geschikt voor 220 V - 240 V wisselspanning.
PL	Instrukcja użytkowania i pielęgnacji	<ul style="list-style-type: none"> • Gwarancja na produkt znajduje się na odwrocie niniejszej instrukcji. • Produkt można zasilać wyłącznie prądem o napięciu AC 220 V - 240 V.
CZ	Průvodce použitím a péčí	<ul style="list-style-type: none"> • Záruka na produkt je vytištěna na zadní straně této příručky. • Tento produkt je vhodný pouze pro napájení střídavým proudem o napětí 220–240 V.
SK	Spríevodca používaním a starostlivosťou	<ul style="list-style-type: none"> • Záručný list výrobku je vytlačený na zadnej strane tejto príručky. • Tento výrobok je určený len na striedavý prúd 220 V - 240 V.
TR	Kullanım ve Bakım Kılavuzu	<ul style="list-style-type: none"> • Ürünün garantisi bu kılavuzun arka kısmında yazılıdır. • Bu ürün yalnızca AC 220 V - 240 V için uygundur.
SV	Guide för användning och skötsel	<ul style="list-style-type: none"> • Produktgarantin är tryckt på baksidan av denna guide. • Denna produkt är endast lämplig för 220 - 240 VAC.
DA	Vejledning til brug og vedligeholdelse	<ul style="list-style-type: none"> • Produktgarantien er trykt bag på denne vejledning. • Dette produkt er kun egnet til AC 220 V - 240 V.
NO	Bruks- og vedlikeholdsveiledning	<ul style="list-style-type: none"> • Produktgarantien er trykket på baksiden av denne veiledningen. • Dette produktet er kun egnet for AC 220 V - 240 V.
RU	Руководство по использованию и уходу	<ul style="list-style-type: none"> • Бланк гарантии на изделие напечатан на обратной стороне данного руководства. • Данное изделие разрешено использовать только в сетях переменного тока напряжением 220–240 В.

MODEL PART DIAGRAM

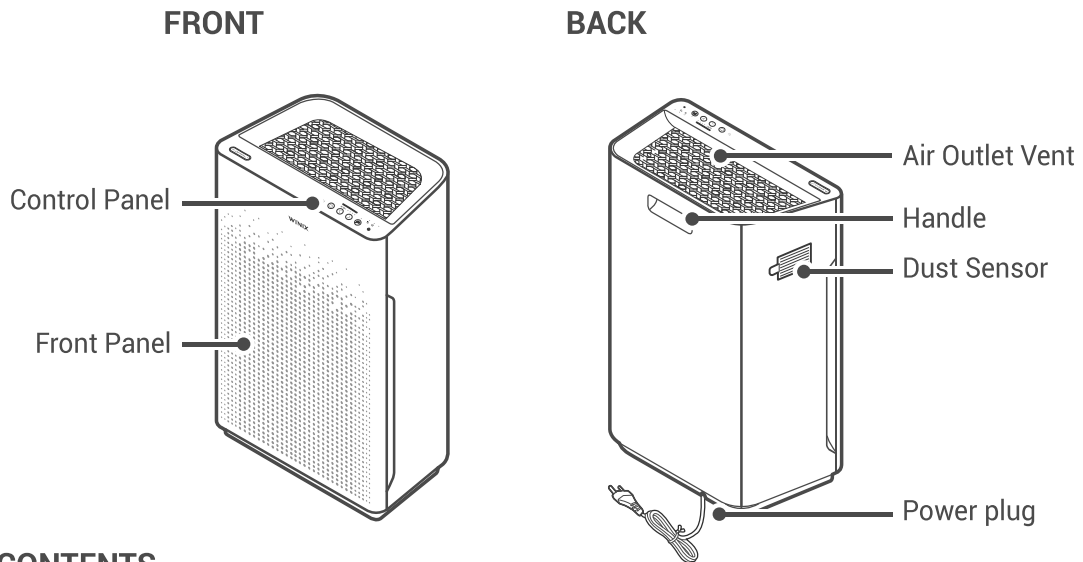

PACKAGE CONTENTS



Unit

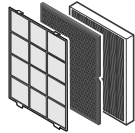

- (1) In front of Pre-Filter
- (1) Active Carbon Filter
- (1) True HEPA Filter



User Manual

WHERE TO USE

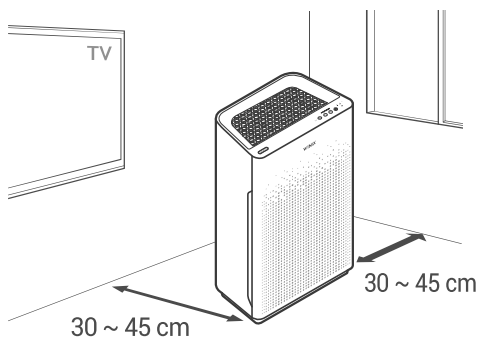

Allow 30 ~ 45 cm. of space between TVs, radios, and other electronics
Electromagnetic interference from certain electronics may cause product malfunction.

Place indoors away from direct sunlight
Direct exposure may cause product malfunction or failure.

Only place on hard, flat surfaces
Flimsy or slanted surfaces may result in abnormal noise and vibrations.

Allow 30 ~ 45 cm. from walls
For maximum air flow.

CONTROL PANEL

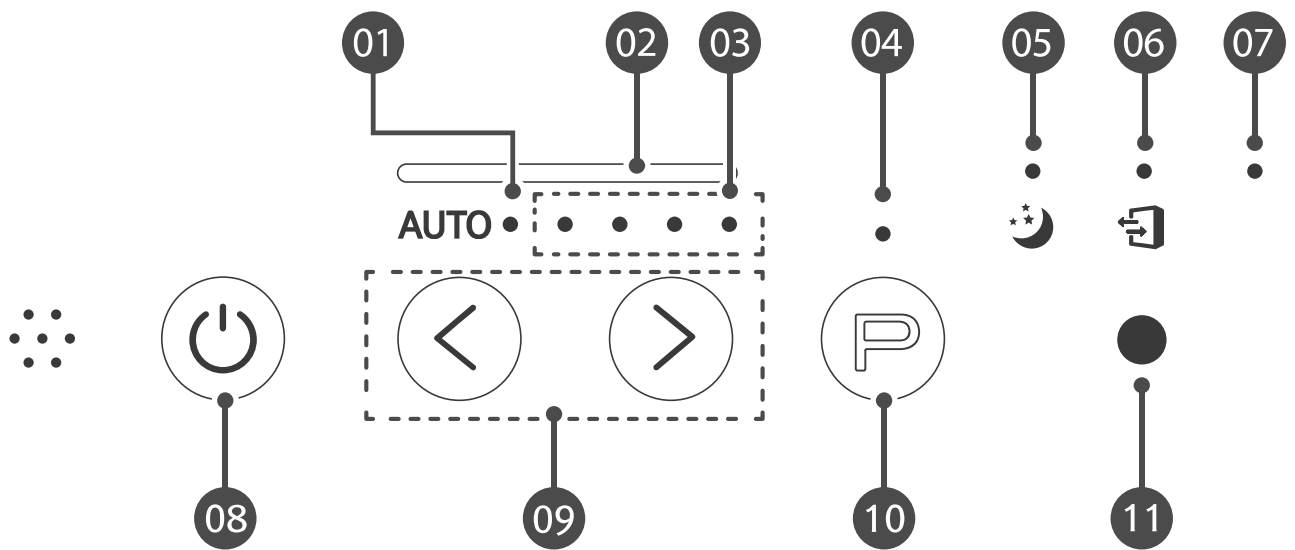

01. Auto Mode Indicator

The LED "Auto" light will indicate when Auto Mode is activated.

02. Air Quality Indicator

Color coded LED light indicates one of three levels of Air Quality: Red (poor), Amber (fair), and Blue (good).

03. Fan Speed Indicator

Indicates the current fan speed.

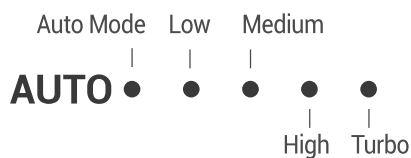

04. PlasmaWave® Indicator

Indicates whether PlasmaWave® is enabled or disabled.

05. Sleep Mode Indicator

When Sleep Mode is activated, the Air Quality Indicator LED light is disabled.

- Fan speed will automatically set to minimum speed (lower than 'Low') which will be nearly silent.
- When Sleep Mode is active, PlasmaWave® will be disabled, but it can be turned back on.

06. Filter Replacement Indicator

LED light indicates when it is time to change the filter.

07. Filter Reset Button

After replacing the True HEPA Filter, use a small object such as a paper clip, to press and hold the Filter Reset Button for at least 5 seconds until the Filter Replacement Indicator turns off.

08. Power Button

Turns the unit on or off. During the first 30 seconds of powering up, the Air Quality Indicator will cycle through Blue, Amber and Red colors.

- Dust Sensor takes approximately 30 seconds to gauge the air quality in the environment before normal detect begins.

09. Mode Button

Press to cycle through to set the mode of operation (Auto, Sleep). The unit will default to Auto with PlasmaWave® enabled when first powered on.

Auto Mode:

- Auto Mode automatically adjusts fan speeds according to your indoor air quality. The fan speed will adjust to low when air quality is good, medium when fair, and to high when poor.

Sleep Mode:

When Sleep Mode is activated, the Air Quality Indicator LED light is disabled.

- Fan speed will automatically set to minimum speed (lower than 'Low') which will be nearly silent.
- When Sleep Mode is active, PlasmaWave® will be disabled, but it can be turned back on.

10. PlasmaWave® Button

Press the Plasmawave® button when the unit is on to enable or disable this feature. By default, PlasmaWave® is enabled whenever the unit is powered on.

"When the unit is running, you may hear a chirping or buzzing sound. The sound is from large particles passing through PlasmaWave®, it is normal and does not signify product failure."

11. Light Sensor

Detects the amount of ambient light in the environment. When in Auto Mode, the Light Sensor detects when to put the unit into Sleep Mode.

4-STAGE AIR PURIFICATION

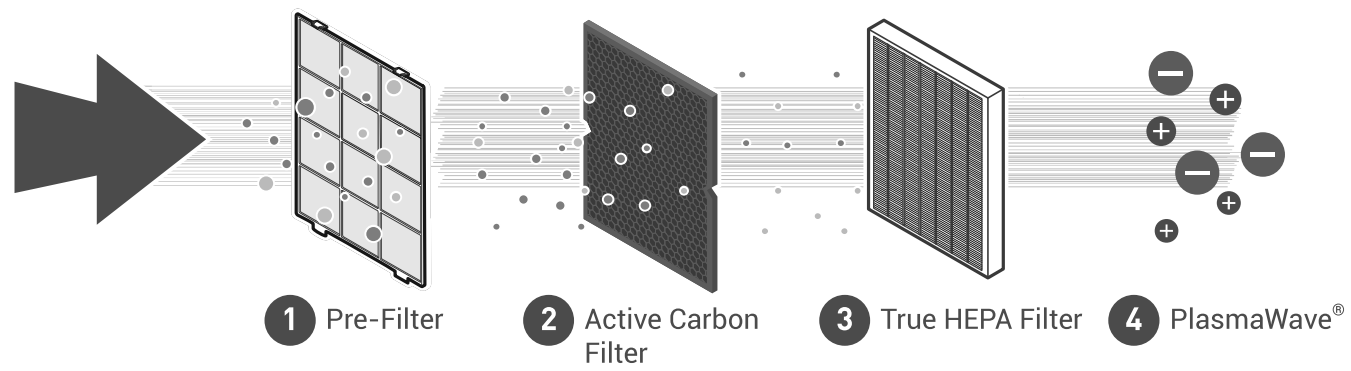

01. Pre-Filter

Designed to catch larger airborne particles found indoors.

02. Active Carbon Filter

Reduces VOCs and household odors from cooking, pets, and smoke.

03. True HEPA Filter

Captures 99.97%* of airborne allergens including; pollen, mold spores, dust, pet dander, microbes, and smoke (*Particles as small as 0.3 microns in size.)

04. PlasmaWave®

PlasmaWave® creates Hydroxyls which can help to reduce the presence of airborne Bacteria, Viruses* (*Based on independent laboratory test conducted on Influenza A Virus H3N2, E. coli, Pseudomonas aeruginosa, Staphylococcus aureus, Salmonella typhimurium.)

MAINTENANCE

When to Replace Filters

Filter	Indicator Light	When to service	When to replace
Pre-Filter	none	Clean once every 14 days	Permanent
Active Carbon Filter	none	Clean once every 3 months	Lasts Approx. 12 months
True HEPA Filter	 Check Filter	Can NOT be WASHED	

- When the Check Filter Indicator LED is on, it is time to replace the True HEPA Filter and Active Carbon Filter.
- Intervals between filter replacement may vary depending on environment.

INITIAL OPERATION

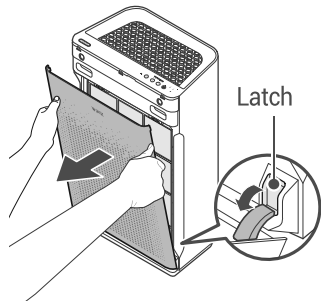

1. Remove the front panel by grasping its upper edge and gently pulling forward.

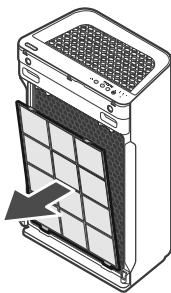

2. Remove the Pre-Filter, then the bag of filters behind it.

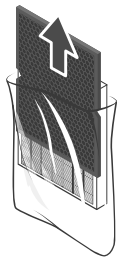

3. Remove filters from protective plastic bag.

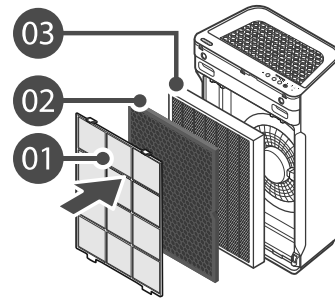

4. Install the filters until they fit securely in place.
03. True HEPA Filter (back)
02. Active Carbon Filter (middle)
01. Pre-Filter (front)

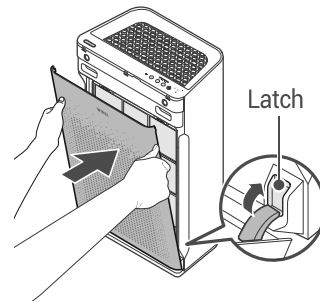

5. After filters are installed, close the front panel.

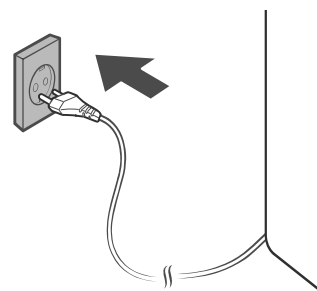

6. Insert the power cord into an electrical outlet.

REPLACING FILTERS

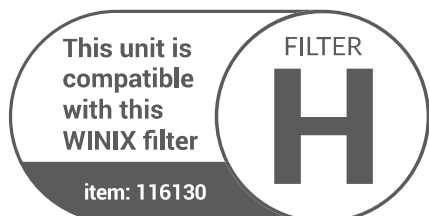

After replacing a filter, press the Filter Reset Button for at least 5 seconds.

CLEANING CARE

Cleaning the Filters:

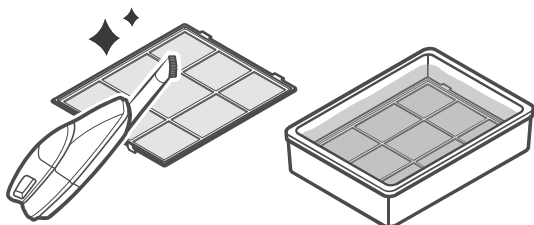

- Use a vacuum cleaner or soft brush to clean the Pre-Filter
- If it is excessively soiled, rinse in room temperature water.
 - Do not use detergent or soap.
 - Allow the filter to dry for 24 hours or more before using.
 - Intervals between filter cleaning may vary depending on the air quality in the environment.
 - Do not use hot water over 40°C.

Particle Sensors Care

1. Use a damp cotton swab to wipe the lens and intake area of the Particle Sensor.
 - To clean the sensor area, use only water. Do not use volatile substances such as alcohol or acetone.
2. Wipe away any remaining moisture with a dry cotton swab.

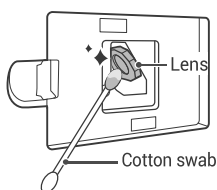

! NOTICE

- Do not use benzene, alcohol, or other volatile fluids, which may cause damage or discoloration.

Cleaning the Exterior & Interior:

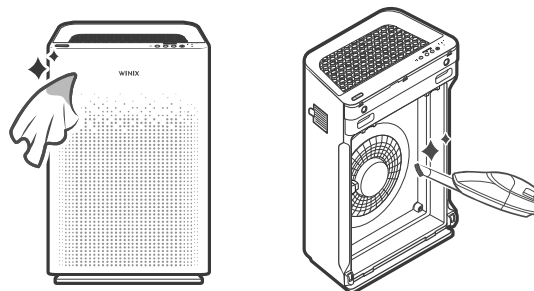

- Wipe with a soft damp cloth using room temperature water.
- Afterwards, wipe it down with a clean, dry cloth.

Open the front panel and clean the interior with a vacuum cleaner.

- For optimal performance, clean every 1 - 2 months.

! NOTICE

- When cleaning the unit, always unplug the power cord first and then wait until the unit has cooled down.
- Never disassemble, repair, or modify this unit yourself.
- Do not use flammable sprays or liquid detergents.
- Do not allow children to clean or maintain the unit.
- Before cleaning or maintaining, ensure unit is unplugged.

SAFETY AND CAUTIONS

Before operating this equipment, carefully read and follow these safety cautions.

Ensure filters are inserted before running unit.

Running the unit without filters can shorten the lifespan of the unit and cause electric shock or injury.

Be sure foreign objects are NOT inserted into the vents on the unit.

Objects can include pins, rods, and coins.

Do not touch any part of the interior of the unit with wet hands.

The high voltage may cause electric shock.

Ensure unit intake and outlet vents do not become blocked.

Blockage may lead to increased internal temperatures, causing product failure and deformation.

Do not use the unit as a step stool or place heavy objects on the unit.

Personal injury may occur or product failure and deformation.



WARNING

Follow these instructions to reduce the risk of serious injury or death and to reduce risk of damaging the unit.

- If the power cord is damaged, it must be replaced by a special cord. Reassembly is available from the manufacturer or its service agent.
- This appliance can be used by children aged from 8 years and above and persons with reduced physical, sensory or mental capabilities or lack of experience and knowledge if they have been given supervision or instruction concerning use of the appliance in a safe way and understand the hazards.
- Children should be supervised to ensure that they do not play with the appliance.
- This unit is not intended to be used to preserve documents or art conservation.



Do not pull on the power cord when unplugging the unit.



Do not tie or knot the power cord when unit is in operation.



If the unit becomes submerged in water, unplug it and contact customer service.



Do not unplug or move the unit while in operation.



Do not plug additional appliances into the same outlet or power supply.



Do not touch the plug with wet hands.



Unplug the unit when not in operation for extended periods of time.



Do not place around heating elements.



Do not use around mist or fumes from industrial oil or around large quantities of metallic dust.



The cord can become damaged by forcefully bending, pulling, twisting, bundling, pinching or placing heavy objects on it.



Do not install in any sort of motor or transport vehicle (trucks, boats, ships, etc.).



Do not place in an area with excessive amounts of noxious gases.



Do not place near any flammable materials (aerosols, fuel, gases, etc.).



Do not have the unit facing into wind or drafts.



Do not place below any electrical outlet.



Do not place in excessively humid areas where the unit may become wet.



To reduce the risk of fire or electric shock, do not use this fan with any solid-state speed control device.



Do not place unit closer than 30 cm from the wall during operation. It may cause condensation on the wall and the surrounding area.

SAFETY INSTRUCTIONS

Thank you for purchasing a Winix air purifier.

IMPORTANT CAUTIONS FOR USING YOUR AIR PURIFIER:

WARNING: Follow the instructions in this manual to reduce the risk of electric shock, short circuit, and/or fire.

- Do not repair or modify the unit. All repairs should be completed by a qualified technician.
- Do not use if the power cord or plug is damaged or the connection to the wall outlet is loose.
- Use AC 220 - 240 V only.
- Do not damage, break, forcefully bend, pull, twist, bundle, coat, pinch, or place heavy objects on the power cord.
- Periodically remove dust from the power plug. This will reduce the risk of shock due to humidity build up.
- Remove the power plug from the outlet before cleaning the unit. When removing the power plug, grasp by holding the plug itself, never hold by the cord.
- If the power plug is damaged, it must be replaced by the manufacturer or a qualified technician.
- Remove the power plug from the outlet when not in use.
- Do not handle the power plug with wet hands.
- Do not operate the unit when using indoor smoke-generating insecticides.
- Do not clean unit with benzene or paint thinner. Do not spray insecticides on the unit.
- Do not use the unit where it is humid or where the unit may become wet, such as the bathroom.
- Do not insert fingers or foreign objects into air intake or outlet.
- Do not use the unit near flammable gases. Do not use near cigarettes, incense, or other spark-creating items.
- Unit will not remove carbon monoxide emitted from heating appliances or other sources.

IMPORTANT PRECAUTIONS FOR USING YOUR AIR PURIFIER:

- Do not block the intake or outlet vents.
- Do not use near hot objects, such as a stove.
- Do not use where the unit may come into contact with steam.
- Do not use the unit on its side.
- Keep away from products that generate oily residue, such as a deep fryer.
- Do not use detergent to clean the unit.
- Do not operate without a filter.
- Do not wash and reuse the True HEPA Filter.
- Hold the handle on the back of the unit to transport.
- Do not hold by the front panel.
- Do not stick any small objects into the air outlet vents or fan.

FREQUENTLY ASKED QUESTIONS

The unit does not turn on at all

- Is the plug securely attached to the outlet?
 - Make sure the outlet has power going to it, and ensure the plug is secured.
- Is there a power outage?
 - Check to see if other lights and electrical equipment are working and try again.

The unit doesn't work in Auto Mode

- Has Auto Mode been selected?
 - Press the Fan Speed button until Auto Mode is selected.
- Is the sensor blocked or clogged?
 - Clean Dust Sensor with vacuum cleaner.

It vibrates and makes a lot of noise

- Is it running on a slanted or uneven surface?
 - Move the unit to a hard, flat, even area.

The power plug and outlet feel hot

- Is the plug securely plugged in?
 - Make sure the plug is properly plugged into the outlet.

There is a strange smell

- Is it being used in a place with a lot of smoke, dust, or odors?
 - Clean the air intakes on either side and clean the Pre-Filter.
 - Replace the Active Carbon Filter and the True HEPA filter.

The fan strength is weak. The unit is not purifying the air

- Is the Check Filter Indicator light on?
 - Change the filters as required.

The display panel is dim

- Is the Light Sensor blocked by debris?
 - When Auto Mode is on, Sleep Mode is automatically activated when the Light Sensor detects that the room is dark.

PRODUCT WARRANTY

The terms of the warranty are as follows:

1. This product is manufactured under stringent quality control and inspections.
2. The warranty will be voided if product failure is a result of negligence or misuse by the consumer.
3. A proof of purchase must be presented upon claiming a Product Warranty.
4. Store the proof of purchase in a safe place or register your product on winixeuropa.eu to upload your proof of purchase.
5. This warranty is valid only in the Europe.

Product Name		Air Purifier
Model Name		AZSU350-JWE
Purchase Date		
Warranty period		Two (2) Years
Place of purchase		
Place of Purchase tel.		
Customer	Address	
	Name	
	Tel.	