

WINIX AIR PURIFIER

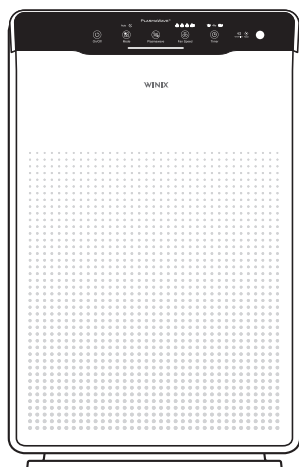

○ Model

ZERO (AZBU330-HWE)

○ Use & Care
Guide



- Please read and follow all safety rules and instructions in this manual before operating.
- The product warranty is printed on the back of this guide, so please keep it in a safe place for future use.

CONTENTS

4-STAGE AIR PURIFICATION	3
CONTROLS	4
WHERE TO USE	4
SAFETY AND CAUTIONS	5
INSTALLING FILTERS	6
INITIAL OPERATION	8
FEATURES	9
REPLACING FILTERS	10
CLEANING CARE	11
FREQUENTLY ASKED QUESTIONS	13
UNIT SPECIFICATIONS	14
PRODUCT WARRANTY	14

► This product is suitable for 220 - 240 V only.

4-STAGE AIR PURIFICATION

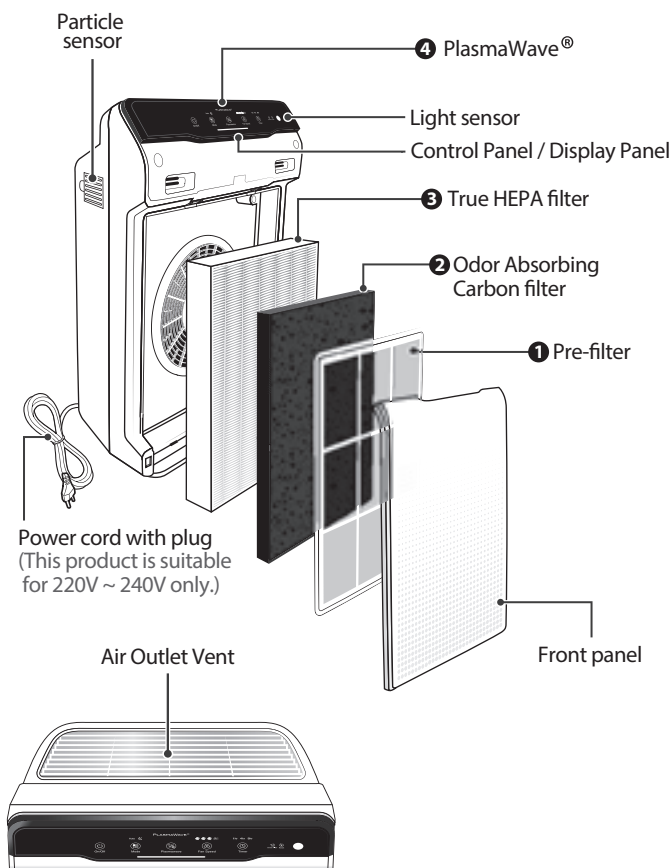

PACKAGE CONTENTS

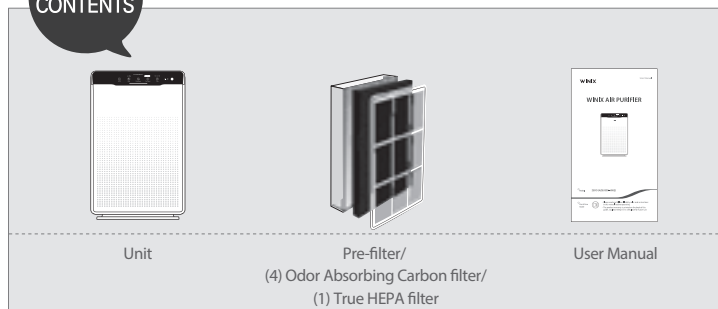

CONTROLS

PlasmaWave® Indicator
Indicates whether PlasmaWave® is enabled or disabled.

Timer Indicator
If timer has been set, the LED light indicates the set time of operation.

Mode Button
Press to cycle through and set the desired mode of operation (Auto, Sleep).

Fan Speed Indicator
Indicates the current fan speed.

Reset Button
After replacing a filter, press the RESET button for at least 5 seconds.

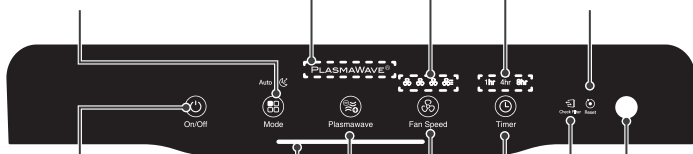

Power Button
Turns the unit on or off.

Air Quality Indicator
Color-coded LED indicates one of three levels of air quality.

PlasmaWave® Button
Enables or disables PlasmaWave®.

Timer Button
Press to cycle through and set desired length of operation (1hr, 4hr, 8hr, [NO TIMER])

Light Sensor
Detects the amount of ambient light within the environment, to adjust the brightness of the LED indicators.

Fan Speed Button
Enables Manual operation of the unit. Press to cycle through and set the desired fan speed (Low, Medium, High, Turbo).

Change Filter Indicator
LED light indicates when it is time to change the filter.

WHERE TO USE

Allow 30 - 45 cm. of space between TVs, radios, and other electronic products
electromagnetic interference from certain electronics may cause product malfunction.

Place indoors away from direct sun light
direct exposure may cause product malfunction or failure.

Only place on hard, flat surfaces
flimsy or slanted surfaces may result in abnormal noise and vibrations.

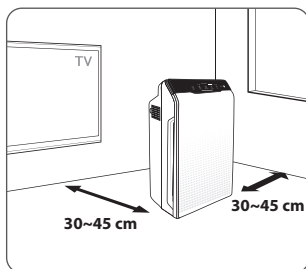

SAFETY AND CAUTIONS

Before operating this equipment, carefully read and follow these safety cautions

Ensure filters are inserted before running unit

running unit without filters can shorten the units life and cause electric shock or injury.

Be sure foreign objects are NOT inserted into the vents on the unit

objects can include pins, rods, and coins.

Do not touch any part of the interior of the unit with wet hands

the high voltage may cause electric shock.

Ensure unit intake and outlet vents do not become blocked

blockage may lead to increased internal temperatures causing product failure and deformation.

Do not use the unit as a step stool or place heavy objects on it

personal injury may occur or product failure and deformation.



WARNING

Follow these instructions to reduce the risk of serious injury or death and to reduce risk of damaging the unit.



Do not pull on the power cord when unplugging the unit



Do not tie or knot power cord when unit is in operation



If the unit becomes submerged in water, unplug it and contact customer service



Do not unplug or move the unit while in operation



Do not plug additional appliances into the same outlet or power supply



Do not touch the plug with wet hands



Unplug unit when not in operation for extended periods of time



Do not place around heating elements.



Do not use around mist or fumes from industrial oil or around large quantities of metallic dust.



Cord can become damaged by forcefully bending, pulling, twisting, bundling, pinching or placing heavy objects on it



Do not install in any sort of motor or transport vehicle (trucks, boats, ships, etc.).



Do not place in an area with excessive amounts of noxious gases.



Do not place near any flammable materials (aerosols, fuel, gases etc.)



Do not have unit facing into wind or draft.



Do not place below any electrical outlet.



Do not place in excessively humid areas where unit may become wet.

※ If the supply cord is damaged, it must be replaced by a special cord or assembly available from the manufacturer or its service agent.

※ This appliance can be used by children aged from 8 years and above and persons with reduced physical, sensory or mental capabilities or lack of experience and knowledge if they have been given supervision or instruction concerning use of the appliance in a safe way and understand the hazards.

※ Children should be supervised to ensure that they do not play with the appliance.

※ This unit is not intended to be used to preserve documents or in art conservation.

INSTALLING FILTERS

This product comes with all required filters. The protective plastic wrap must be removed from the filter before use.

- ※ Operating the unit without removing the plastic wrap may result in product failure.
- ※ Unplug and make sure the unit is turned off before installing filter.

- ① Remove the front panel by grasping its upper edge and gently pulling forward.

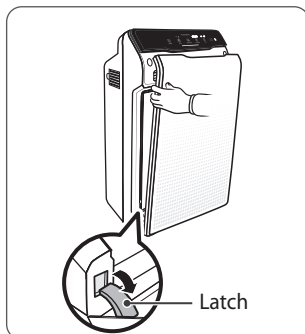

- ② Remove the filters from the unit, they are protected inside a plastic wrap

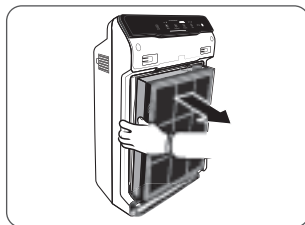

- ③ Remove filters from protective plastic wrap.
- Operating the unit without removing filters from plastic wrap may cause abnormal noise, deformation, or fire as a result of overheating.

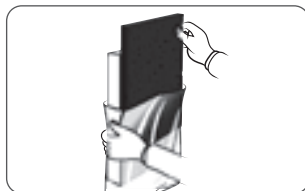

- ④ Install the filters until they fit securely in place.

Filters must be installed in this order:

3 True HEPA filter (rear)

2 Odor Absorbing Carbon filter (middle)

1 Pre-filter (front)

- To install the Pre-filter, insert bottom tabs into the slots on either side of the lower part of the unit, then rotate upward to insert the upper tabs into the slots at the top part of the unit until sides audibly click into place.

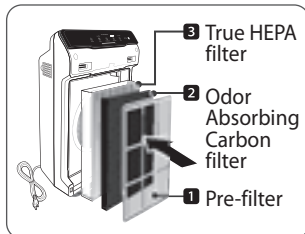

INSTALLING FILTERS

- ⑤ Replace the front panel by first inserting the latch at the bottom edge into the base of the unit, then rotate the panel upward toward the top of the unit until the magnets pull the lid closed.

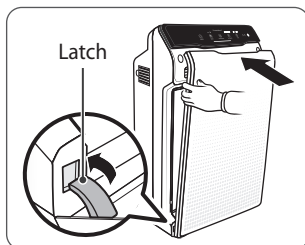

When to Replace Filters

When the Check Filter indicator LED is on, it is time to replace both the True HEPA.

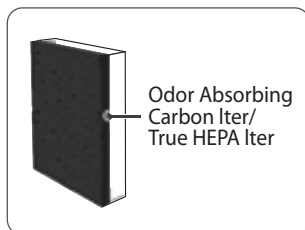

NOTE

- The filters' life varies depending on the level of pollutants in the air. The more dust present in the environment, the more dust accumulates in the filters, shortening the life.
- If the filters are heavily soiled or have a bad odour, or if the fan strength is significantly weakened, replace filters even if the Change Filter indicator has not yet turned on.

When to service and replace filter:

Filter	Indicator Light	When to service	When to replace
1 Pre-filter	none	Clean once every 14 days	Permanent
2 Odor Absorbing Carbon filter	none	Can NOT be WASHED	Replace every 3 months
3 True HEPA filter	 Check Filter		Lasts up to 6~12 months

- Intervals between filter replacement may vary depending on environment.
- For optimal use, Pre-filter can be cleaned once every 14 days which can extend the life of other filters.

To purchase replacement Winix filters:

contact your local dealer

this unit is compatible with this WINIX filter

item: 115115



INITIAL OPERATION

- ① Insert the power cord into an electrical outlet.

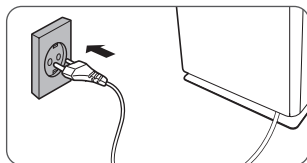

- ② Press the 'Power' button.
 - During the first 30 seconds of power up, the Air Quality Indicator will cycle through Blue, Yellow and Red colors.
 - Particle Sensors take approximately 30 seconds to gauge the air quality in the environment before normal operation begins.

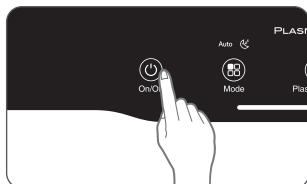

- ③ Set desired fan speed by using Auto or Manual Mode.
 - By default, when the unit first powers on, the mode will be set to Auto with PlasmaWave® enabled.



Auto Mode

Enables auto operation based on the unit's air quality Particle Sensor.

- ① Press the Mode button to select Auto mode.
 - The LED 'Auto' light will indicate when Auto mode is activated, and operation will begin.

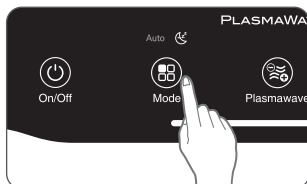

Manual Mode

Manually setting the fan speed.

- ① Press the Fan Speed button to set the desired fan speed to Low, Medium, High, or Turbo.
 - When Manual Mode is selected, Auto Mode and Sleep Mode is automatically disabled.

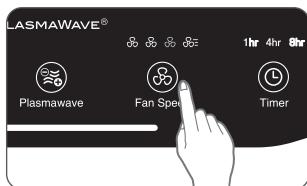

NOTE

- When in Auto mode the fan speed is automatically adjusted according to the indoor air quality.
- As the indoor air quality improves, the fan speed will automatically be reduced. If the indoor air quality decreases, the fan speed will automatically increase.

FEATURES

PlasmaWave®

By default, PlasmaWave® is enabled whenever the unit is powered on.

- 1 Press the Plasmawave button, when the unit is on, to enable or disable this feature.
 - PlasmaWave® works to remove harmful airborne contaminants.
 - When the unit is running, you may hear a chirping or buzzing sound. The sound is from large particles passing through PlasmaWave®, it is normal and does not signify product failure.

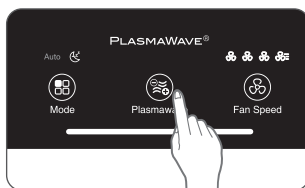

Air Quality Indicator

When the unit is on, the LED light will indicate the current indoor air quality according to three levels: BLUE (good), AMBER (fair), RED (poor).

- Air quality level is displayed on the indicator, based on the Particle Sensors.
- Depending on the immediate environment, the indicator may change frequently in color or stay the same for lengthy periods of time.

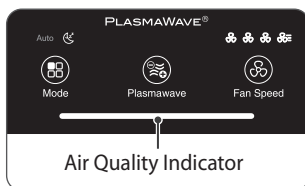

Sleep Mode

When Sleep mode is selected, the fan speed is automatically set to Low and the Air Quality Indicator LED light is disabled.

- 1 Press the Mode button to select Sleep mode.
 - The LED 'Sleep' light will indicate when Sleep mode is activated.
 - The fan speed can be manually changed by pressing the Fan Speed button, changing the unit into manual mode.
 - When Sleep Mode is activated, the Air Quality Indicator LED light is disabled.

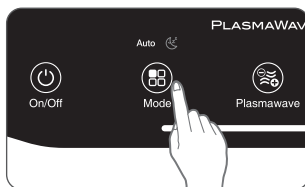

Timer

The timer can be set to let the unit run for a specified period of time.

- 1 Press the Timer button to select the desired length of time.
 - When the Timer LED light will indicate the selected length of operation.
 - Every time the Timer button is pressed, the Timer LED light will cycle through the settings, (1hr, 4hr, 8hr, [NO TIMER]).

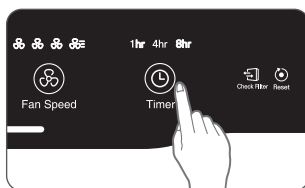

REPLACING FILTERS

1. Removing Filters

Turn the unit power off before removing filters.

Reference steps 1-2 on page 6 (Installing Filters) to remove all filters.

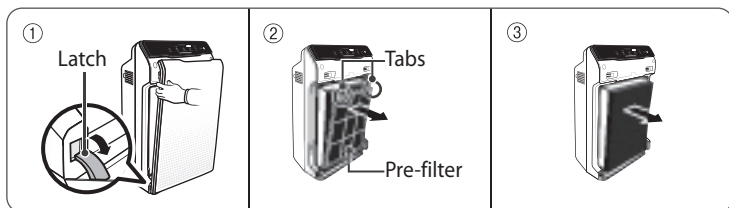

- ① Remove the front panel by grasping its upper edge and gently pulling forward. Press on the Pre-filter tabs.
- ② near the top of the filter, release and remove.
- ③ Pull out the Odor Absorbing Carbon filter and True HEPA filter.

2. Prepare New Filters

- ① **Remove filters from protective plastic wrap.**

- Operating the unit without removing filters from plastic wrap may cause abnormal noise, deformation, or fire as a result of overheating.

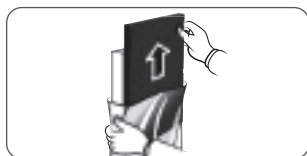

! NOTICE

- For optimal performance, only Winix filters should be used with this unit.

3. Insert New Filters

Install the filters until they fit securely in place. Reference Step 4 on page 6 (Installing Filters).

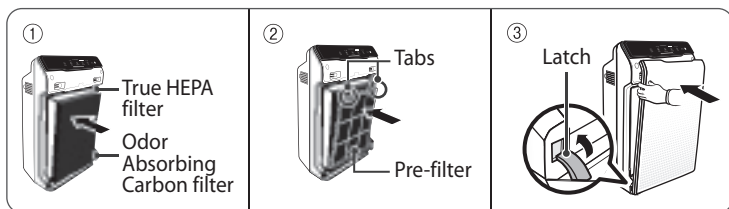

- ① Insert the True HEPA filter first, then the Odor Absorbing Carbon filter.
- ② Insert the Pre-filter.
- ③ Put the front panel back on.

4. Resetting the Unit

- ① After replacing the filters, turn the power onto the unit and then use a thin object, such as a paper clip, to press the RESET switch for 5 seconds.

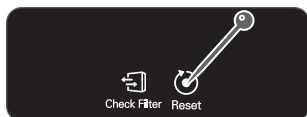

CLEANING CARE

1. Cleaning the filter

Intervals between filter cleaning may vary depending on the air quality.

- ① Use a vacuum cleaner or soft brush to clean the Pre-filter. If it is excessively soiled, rinse in room temperature water.
 - Do not use detergent or soap.
 - Allow the filter to dry for 24 hours or more before using.

※ If the pre-filter becomes damaged or in any way needs replacement:
Please contact your local dealer

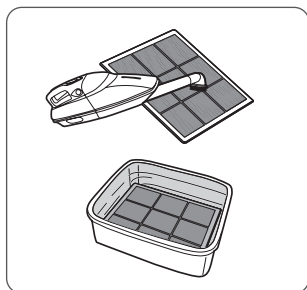

! NOTICE

- Do not use benzene, alcohol, or other volatile fluids, which may cause damage or discoloration.
- The Pre-filter is reusable after cleaning, ensuring it is completely dry.
- Do not use hot water over 40°C or volatile fluids such as paint thinner.
- After washing the filter, allow it to dry completely in a well ventilated area. Otherwise, it may develop a bad odour.

2. Cleaning the Exterior & Interior

- ① Wipe with a soft damp cloth using room temperature water. Afterwards, wipe it down with a clean dry cloth.
 - To keep unit in peak condition, clean every 1-2 months.
- ② Open the front panel and clean the interior with a vacuum cleaner.
 - For optimal performance, clean every 1-2 months.



! NOTICE

- When cleaning the unit, always unplug the power cord first and then wait until the unit has cooled down.
- Never disassemble, repair, or modify this unit yourself.
- Do not use flammable sprays or liquid detergents.
- Do not allow children to clean or maintain the unit.
- Before cleaning or maintaining, ensure unit is unplugged.

CLEANING CARE

3. Particle Sensors Care

For optimal performance of the Particle Sensor, which detects airborne dust and ultrafine particles, clean it every two months. Clean it more frequently when the unit is running in a place with high dust levels.

- ① Open the Particle Sensor cover.

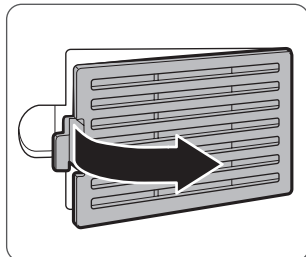

- ② Use a damp cotton swab to wipe the lens and intake area of the Particle Sensor.
 - To clean the sensor area, use only water. Do not use volatile substances such as alcohol or acetone

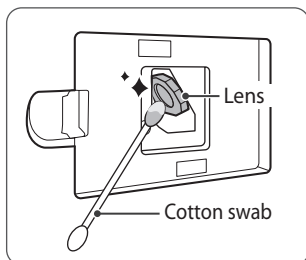

- ③ Wipe away any remaining moisture with a dry cotton swab.

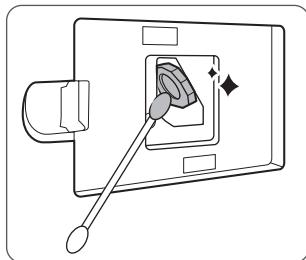

- ④ Close the Particle Sensor cover.
 - The Particle Sensors cover may be cleaned using a vacuum cleaner

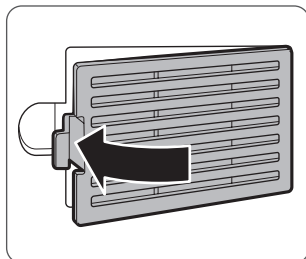

FREQUENTLY ASKED QUESTIONS

Problem	Check / Actions to take
<p>It does not turn on at all.</p>	<ul style="list-style-type: none"> • Is the plug securely attached to the outlet? <ul style="list-style-type: none"> – Make sure the outlet has power going to it, and ensure the plug is secured. • Is there a power outage? <ul style="list-style-type: none"> – Check to see if other lights and electrical equipment are working and try again.
<p>It doesn't work in Auto Mode.</p>	<ul style="list-style-type: none"> • Has Auto Mode been selected? <ul style="list-style-type: none"> – Press the Mode button until Auto Mode is selected. • Is the sensor blocked or clogged? <ul style="list-style-type: none"> – Wipe Odour Sensor with wet cloth, then dry.
<p>It vibrates and makes a lot of noise.</p>	<ul style="list-style-type: none"> • Is it running on a slanted or uneven surface? <ul style="list-style-type: none"> – Move the unit to a hard, flat, even area of the floor.
<p>The power plug and outlet feel hot.</p>	<ul style="list-style-type: none"> • Is the plug securely plugged in? <ul style="list-style-type: none"> – Make sure the plug is properly plugged into the outlet.
<p>There is a strange smell.</p>	<ul style="list-style-type: none"> • Is it being used in a place with a lot of smoke, dust, or odours? <ul style="list-style-type: none"> – Clean the air intakes on either side and clean the pre-filter. – Clean or change the filter.
<p>The fan strength is weak. The unit is not purifying the air.</p>	<ul style="list-style-type: none"> • Is the Check Filter indicator light on? <ul style="list-style-type: none"> – Change the filters as required.
<p>The display panel is dim.</p>	<ul style="list-style-type: none"> • Is the Light Sensor blocked by debris? <ul style="list-style-type: none"> – When Auto Mode is on, Sleep Mode is automatically activated when the Light Sensor detects that the room is dark.

UNIT SPECIFICATIONS

Model Name	ZERO (AZBU330-HWE)
Power Voltage	AC 220 - 240 V, 50 / 60 Hz
Power Rate	70 W
Max Room Capacity	99 m ²
Dimensions	380 mm(W) x 208 mm(D) x 600 mm(H)
Weight	6.7 kg
Replacement Filter	Filter A / item : 115115
Pre-filter	Part # : 4521-0012-01

※ The exterior, design, and product specifications may be changed without prior notice to improve product performance.

PRODUCT WARRANTY

The terms of the warranty are as follows.

- 1 This product is manufactured under stringent quality control and inspections.
- 2 Warranty void if product failure is a result of negligence or misuse by the consumer, shipping and service fees may be incurred even during the warranty period.
- 3 The warranty must be presented upon bringing the product for service.
- 4 Store the warranty in a safe place, as it cannot be reissued.
- 5 This warranty is valid only in the Europe.

Product Name	Air Purifier	
Model Name	ZERO	
Purchase Date		
Warranty period	Two (2) Years	
Place of purchase		
Place of purchase Tel.		
Customer	Address	
	Name	
	Tel.	

※ After purchase, be sure to complete all of the above information.



WINIX

2610-0296-00 Rev.00

○ Contact your local
dealer for product
related inquiries and
customer service

www.winix.com/eu