

FKC08 SERIES

DC-DC CONVERTER

2:1 WIDE INPUT RANGE
UP TO 8 Watts

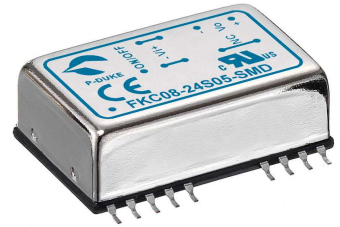
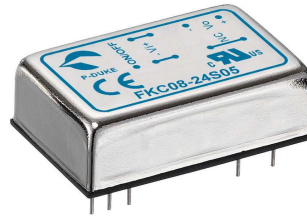

FEATURES

- NO MINIMUM LOAD REQUIRED
- 1600VDC INPUT TO OUTPUT ISOLATION
- STANDARD 1.25 X 0.80 X 0.40 INCH 24 PIN DIP AND SMD PACKAGE
- UL60950-1, EN60950-1, & IEC60950-1 SAFETY APPROVALS
- CE MARKED
- COMPLIANT TO RoHS II & REACH

APPLICATIONS

- WIRELESS NETWORK
- TELECOM/DATACOM
- INDUSTRY CONTROL SYSTEM
- DISTRIBUTED POWER ARCHITECTURES
- SEMICONDUCTOR EQUIPMENT

1600VDC ISOLATION	REMOTE CONTROL	OCP	SCP
-------------------	----------------	-----	-----

TECHNICAL SPECIFICATION

All specifications are typical at nominal input, full load and 25°C otherwise noted

Model Number	Input Range VDC	Output Voltage VDC	Output Current @Full Load mA	Input Current @ No Load mA	Efficiency %	Maximum Capacitor Load µF
FKC08-12S33	9 ~ 18	3.3	2000	10	80	3300
FKC08-12S05	9 ~ 18	5	1500	15	83	1600
FKC08-12S12	9 ~ 18	12	666	13	88	350
FKC08-12S15	9 ~ 18	15	533	20	87	240
FKC08-12D05	9 ~ 18	±5	±800	15	83	±1000
FKC08-12D12	9 ~ 18	±12	±333	20	87	±160
FKC08-12D15	9 ~ 18	±15	±267	20	85	±100
FKC08-24S33	18 ~ 36	3.3	2000	10	80	3300
FKC08-24S05	18 ~ 36	5	1500	30	83	1600
FKC08-24S12	18 ~ 36	12	666	13	86	350
FKC08-24S15	18 ~ 36	15	533	15	85	240
FKC08-24D05	18 ~ 36	±5	±800	15	82	±1000
FKC08-24D12	18 ~ 36	±12	±333	15	86	±160
FKC08-24D15	18 ~ 36	±15	±267	13	85	±100
FKC08-48S33	36 ~ 75	3.3	2000	7	80	3300
FKC08-48S05	36 ~ 75	5	1500	8	83	1600
FKC08-48S12	36 ~ 75	12	666	10	86	350
FKC08-48S15	36 ~ 75	15	533	10	86	240
FKC08-48D05	36 ~ 75	±5	±800	8	85	±1000
FKC08-48D12	36 ~ 75	±12	±333	8	87	±160
FKC08-48D15	36 ~ 75	±15	±267	7	87	±100

PART NUMBER STRUCTURE

FKC08 -	48	S	05	-	SMD
Series Name	Input Voltage (VDC)	Output Quantity	Output Voltage (VDC)		Mounting Type Option
	12: 9~18 24: 18~36 48: 36~75	S: Single	33: 3.3 05: 5 12: 12 15: 15		D: DIP type SMD: SMD type
		D: Dual	05: ± 5 12: ±12 15: ±15		

INPUT SPECIFICATIONS

Parameter	Conditions		Min.	Typ.	Max.	Unit
Operating input voltage range	12Vin(nom)		9	12	18	VDC
	24Vin(nom)		18	24	36	
	48Vin(nom)		36	48	75	
Start up time	Constant resistive load	Power up Remote ON/OFF		700 5		ms
Input surge voltage	100 ms, max.	12Vin(nom) 24Vin(nom) 48Vin(nom)			36 50 100	VDC
Input reflected ripple current				20		mAp-p
Input filter				Pi type		
Remote ON/OFF	Referred to -Vin pin	Positive logic DC-DC ON DC-DC OFF			Open or 3.5 ~ 12VDC Short or 0 ~ 1.2VDC	
		Input current of Ctrl pin Remote off input current	-0.5		+0.5	mA mA
				2.5		

OUTPUT SPECIFICATIONS

Parameter	Conditions		Min.	Typ.	Max.	Unit
Voltage accuracy			-1.0		+1.0	%
Line regulation	Low Line to High Line at Full Load		-0.2		+0.2	%
Load regulation	No Load to Full Load	DIP type	-0.5		+0.5	%
		SMD type	-1.0		+1.0	
		Single	-1.0		+1.0	
		Dual	-1.0		+1.0	
Cross regulation	Asymmetrical load 25%/100% FL	Dual	-5.0		+5.0	%
Ripple and noise	20MHz bandwidth			50		mVp-p
Temperature coefficient			-0.02		+0.02	%/°C
Transient response recovery time	25% load step change			200		µs
Over load protection	% of Iout rated			150		%
Short circuit protection			Continuous, automatic recovery			

GENERAL SPECIFICATIONS

Parameter	Conditions		Min.	Typ.	Max.	Unit
Isolation voltage	1 minute	DIP type	1600			VDC
		SMD type	1600			
		Input to Output	1600			
		Input (Output) to Case	1000			
Isolation resistance	500VDC		1			GΩ
Isolation capacitance					300	pF
Switching frequency			270	300	330	kHz
Safety approvals			UL60950-1 EN60950-1 IEC60950-1			
Case material			Nickel-coated copper			
Base material			Non-conductive black plastic			
Potting material			Epoxy (UL94 V-0)			
Weight			18g (0.62oz)			
MTBF	MIL-HDBK-217F		3.543 x 10 ⁶ hrs			

ENVIRONMENTAL SPECIFICATIONS

Parameter	Conditions		Min.	Typ.	Max.	Unit
Operating ambient temperature	Without derating		-40		+70	°C
	With derating		+70		+100	
Maximum case temperature					100	°C
Storage temperature range			-55		+125	°C
Thermal impedance	Natural convection			20		°C/W
Thermal shock			MIL-STD-810F			
Vibration			MIL-STD-810F			
Relative humidity			5% to 95% RH			

EMC SPECIFICATIONS

Parameter	Conditions		Level
EMI ⁽¹⁾	EN55022		Class A · Class B
ESD	EN61000-4-2	Air ± 8kV and Contact ± 6kV	Perf. Criteria A
Radiated immunity	EN61000-4-3	10 V/m	Perf. Criteria A
Fast transient ⁽²⁾	EN61000-4-4	± 2kV	Perf. Criteria A
Surge ⁽²⁾	EN61000-4-5	± 1kV	Perf. Criteria A
Conducted immunity	EN61000-4-6	10 Vr.m.s	Perf. Criteria A
Power frequency magnetic field	EN61000-4-8	100A/m continuous; 1000A/m 1 second	Perf. Criteria A

Note:

- The standard modules meet EMI Class A or Class B with external components. For further information, please contact with P-DUKE.
- An external input filter capacitor is required if the module has to meet EN61000-4-4, EN61000-4-5. The filter Power Mate suggests: Nippon chemi-con KY series, 220µF/100V.

CAUTION: This power module is not internally fused. An input line fuse must always be used.

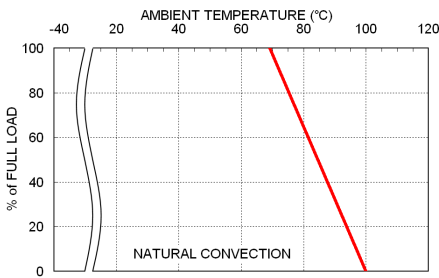
CHARACTERISTIC CURVE

FKC08-48S05 Derating Curve

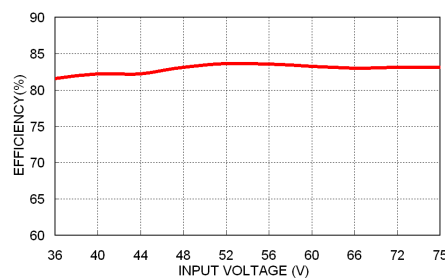

FKC08-48S05 Efficiency vs. Input Voltage

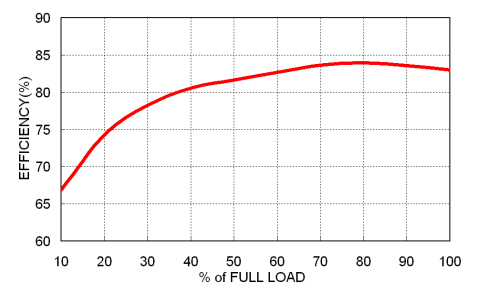

FKC08-48S05 Efficiency vs. Output Load

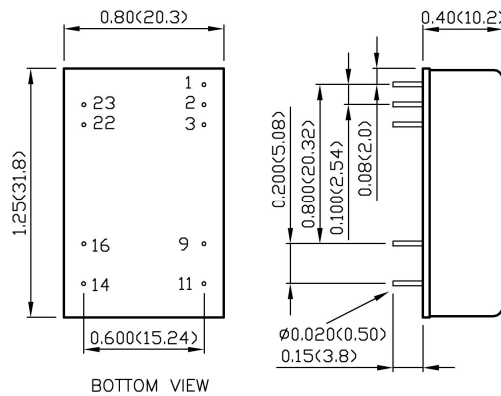
MECHANICAL DRAWING
DIP type

BOTTOM VIEW

PIN CONNECTION

PIN	SINGLE	DUAL	PIN	SINGLE	DUAL
1	Ctrl	Ctrl			
2	-Vin	-Vin	23	+Vin	+Vin
3	-Vin	-Vin	22	+Vin	+Vin
9	NC	Common	16	-Vout	Common
11	NC	-Vout	14	+Vout	+Vout

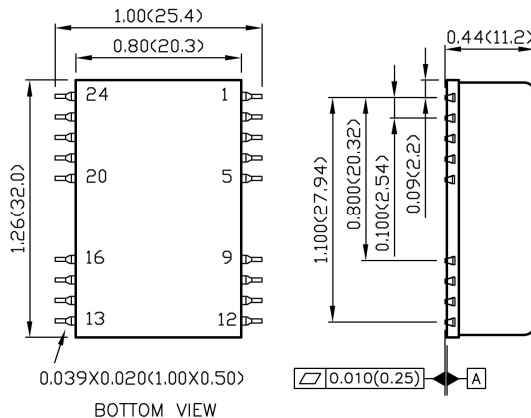
SMD type

BOTTOM VIEW

PIN CONNECTION

PIN	SINGLE	DUAL	PIN	SINGLE	DUAL
1	Ctrl	Ctrl			
2	-Vin	-Vin	23	+Vin	+Vin
3	-Vin	-Vin	22	+Vin	+Vin
9	NC	Common	16	-Vout	Common
11	NC	-Vout	14	+Vout	+Vout
Others	NC	NC			

- All dimensions in inch (mm)
- Tolerance :x.xx±0.02 (x.x±0.5)
x.xxx±0.01 (x.xx±0.25)
- Pin pitch tolerance ±0.01 (0.25)
- Pin dimension tolerance ±0.004(0.1)