

16-port Coax + 2-port 10/100/1000T + 2-port 100/1000X SFP Long Reach PoE over Coaxial Managed Switch



PLANET Long Reach PoE Solution enables all enterprises and network service providers to set up an IP infrastructure in a remote location where 802.3af/at PoE compliant powered devices can receive both data and power via PLANET switches, and PLANET LRP extenders and injectors over a long distance but not limited to the normal 100 meters.

Intelligent Long Reach PoE Switch on Coaxial-based Network

PLANET LRP-1622CS, a brand-new Multi-channel Long Reach PoE Switch, features an extended Ethernet and PoE networking of up to 1 kilometer over the existing coaxial cables going to multiple PoE compliant devices. It provides IPv6/IPv4 dual stack management and built-in L2/L4 Gigabit Switching engine along with 16 BNC ports with Long Reach PoE Injector function, 2 Gigabit copper ports and 2 extra 100/1000BASE-X SFP fiber slots. Each of the 16 BNC ports provides 36 watts of power with a total power budget of up to 440 watts. As an advanced PoE switch, the LRP-1622CS features intelligent PoE functions to improve the availability of critical applications. It provides a quick, safe and cost-effective PoE network solution to upgrading the existing coaxial cable infrastructure from the analog system to the HD IP surveillance system.

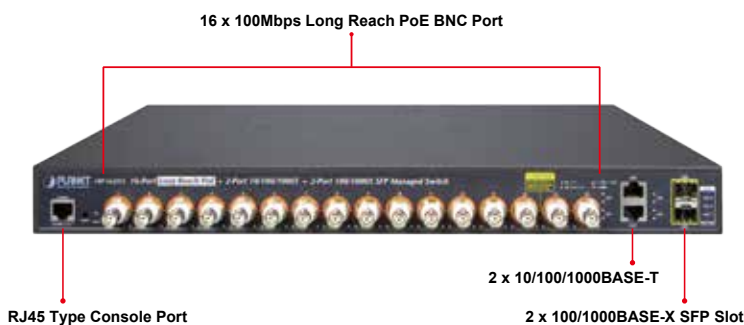

Physical Port

- 16 100Mbps BNC female ports with Long Reach PoE Injector function
- 2 10/100/1000BASE-T Gigabit RJ45 copper ports
- 2 100/1000BASE-X mini-GBIC/SFP slots
- RJ45 console interface for switch basic management and setup

Long Reach Power over Ethernet

- Supports PoE power up to 36 watts for each PoE port
- Remote power feeding up to 1 kilometer with 5C2V/RG6 75Ω coaxial cable
- Long Reach PoE Management
 - Total Long Reach PoE power budget control
 - Per port Long Reach PoE function enable/disable
 - Long Reach PoE port power feeding priority
 - Per Long Reach PoE port power limitation
 - Long Reach PD alive check
 - Long Reach PoE schedule

Layer 2 Features

- Prevents packet loss with back pressure (half-duplex) and IEEE 802.3x pause frame flow control (full-duplex)
- High performance Store and Forward architecture, broadcast storm control, runt/CRC filtering that eliminates erroneous packets to optimize the network bandwidth
- Supports VLAN
 - IEEE 802.1Q tagged VLAN
 - Provider Bridging (VLAN Q-in-Q, IEEE 802.1ad) support
 - Protocol VLAN
 - Voice VLAN
 - Private VLAN
 - Management VLAN
 - GVRP
- Supports Spanning Tree Protocol
 - STP (Spanning Tree Protocol)
 - RSTP (Rapid Spanning Tree Protocol)
 - MSTP (Multiple Spanning Tree Protocol)
 - STP BPDU Guard, BPDU Filtering and BPDU Forwarding
- Supports Link Aggregation
 - IEEE 802.3ad Link Aggregation Control Protocol (LACP)
 - Cisco ether-channel (static trunk)
 - Maximum 4 trunk groups, up to 4 ports per trunk group
- Provides port mirror (many-to-1)
- Loop protection to avoid broadcast loops

Quality of Service

- Ingress/egress rate limit per port bandwidth control
- Storm control support
 - Broadcast / unknown unicast / unknown multicast

Multi-channel Long Reach Power over Ethernet

To support the enterprises in easily building a multi-channel and centrally-controlled Long Reach PoE system, the LRP-1622CS works with the Long Reach PoE Extenders, LRP-101CE, via its 16 BNC ports being the Long Reach PoE injectors for all connected LRP Extenders. Each of the BNC port features long range data and power transmission for distance up to 1,000m (3,280ft) over coaxial cable to the LRP Extender, and another 100m over Ethernet cable to remote PoE IP camera, PoE wireless AP or access control systems complied with 802.3af/at PoE.

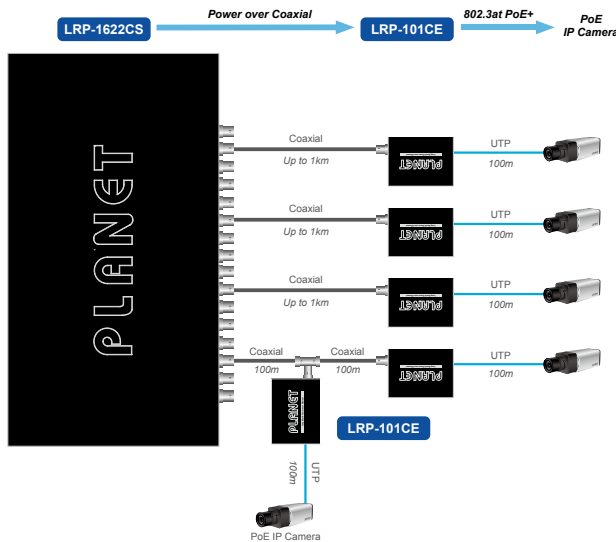

Centralized Power Management

With the centrally-managed 440-watt PoE budget, the LRP-1622CS eliminates the need for an additional remote site power while allowing a single power source to provide power to both LRP extenders and the PoE powered devices at long range. The Long Reach PoE capabilities provided help to reduce installation time and deployment costs for network devices as a result of freeing from restrictions of power outlet locations.

Daisy-chaining Multiple Nodes

PLANET Long Reach PoE solution can easily build a power system for centrally-controlled IP cameras in a high availability network infrastructure. It gives users the flexibility to expand small area network with BNC T-connector for sharing four nodes per port when needed, making the LRP-1622CS with 16 BNC Long Reach PoE Ports an ideal support for up to 64 IP cameras.

Built-in Unique PoE Functions for Powered Devices Management

As a managed PoE switch for surveillance, wireless and VoIP networks, the LRP-1622CS particularly features the following special PoE Management functions to accomplish a highly-efficient Long Reach network:

- PD Alive Check
- Scheduled Power Recycling
- PoE Schedule
- PoE Usage Monitoring
- PoE Over-temperature Protection

Intelligent Powered Device Alive Check

The LRP-1622CS can be configured to monitor connected PD (Powered Device) status in real time via ping action. Once the PD stops working and responding, the LRP-1622CS will resume the PoE port power and bring the PD back to work. It will greatly enhance the network reliability through the PoE port resetting the PD's power source and reducing administrator management burden.

- Traffic classification
 - IEEE 802.1p CoS
 - ToS/DSCP/IP Precedence of IPv4/IPv6 packets
- Strict priority and Weighted Round Robin (WRR) CoS policies

Multicast

- Supports IGMP snooping v2 and v3
- Supports MLD snooping v1, v2
- IGMP querier mode support
- IGMP snooping port filtering
- MLD snooping port filtering

Security

- Authentication
 - IEEE 802.1X Port-based network access authentication
 - Built-in RADIUS client to co-operate with the RADIUS servers
 - RADIUS/TACACS+ login user access authentication
- Access Control List
 - IPv4/IPv6 IP-based ACL
 - MAC-based ACL
- MAC Security
 - Static MAC
 - MAC filtering
- Port security for source MAC address entries filtering
- DHCP snooping to filter untrusted DHCP messages
- Dynamic ARP inspection discards ARP packets with invalid MAC address to IP address binding
- IP source guard prevents IP spoofing attacks
- DoS attack prevention
- SSH/SSL

Management

- IPv4 and IPv6 dual stack management
- Switch management interface
 - Web switch management
 - Telnet command line interface
 - SNMP v1, v2c and v3
 - SSH/SSL secure access
- User privilege levels control
- Built-in Trivial File Transfer Protocol (TFTP) client
- BOOTP and DHCP for IP address assignment
- System maintenance
 - Firmware upload/download via HTTP/TFTP
 - Configuration upload/download through Web interface
 - Dual images
 - Hardware reset button for system reboot or reset to factory default
- SNMP Network Time Protocol
- Cable diagnostics
- Link Layer Discovery Protocol (LLDP) and LLDP-MED
- SNMP trap for interface linkup and linkdown notification
- Event message logging to remote Syslog server
- Four RMON groups (history, statistics, alarms and events)
- PLANET Smart Discovery utility
- Smart fan with speed control

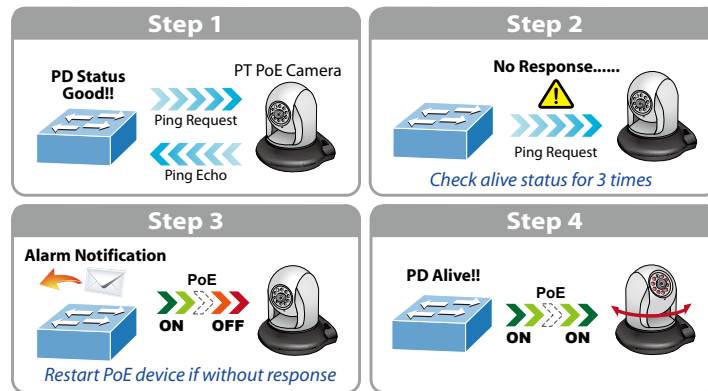

Scheduled Power Recycling

The LRP-1622CS allows each of the connected PoE IP cameras or PoE wireless access points via the LRP-101CE Long Reach PoE Extender to reboot at a specific time each week. Therefore, it will reduce the chance of IP camera or wireless AP crash resulting from buffer overflow.

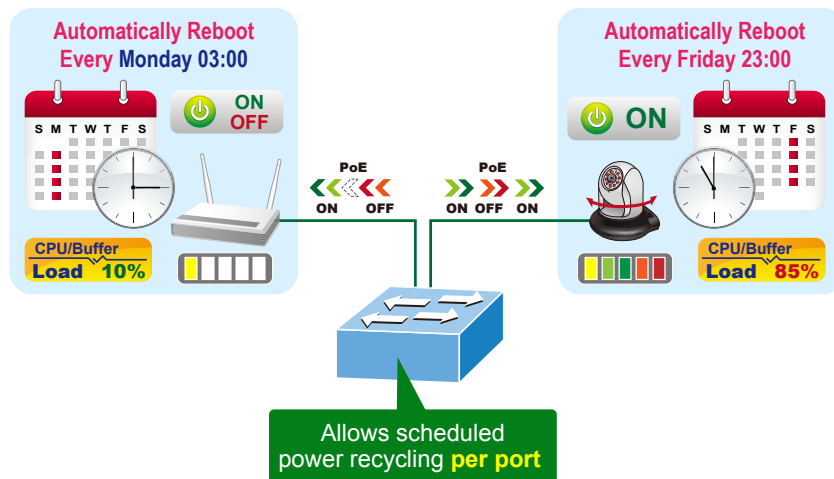

PoE Schedule for Energy Saving

Under the trend of energy saving worldwide and contributing to environmental protection, the LRP-1622CS can effectively control the power supply besides its capability of giving high watts power. The “PoE schedule” function helps you to enable or disable PoE power feeding for each PoE port during specified time intervals and it is a powerful function to help SMBs or enterprises save power and money. It also increases security by powering off PDs that should not be in use during non-business hours.

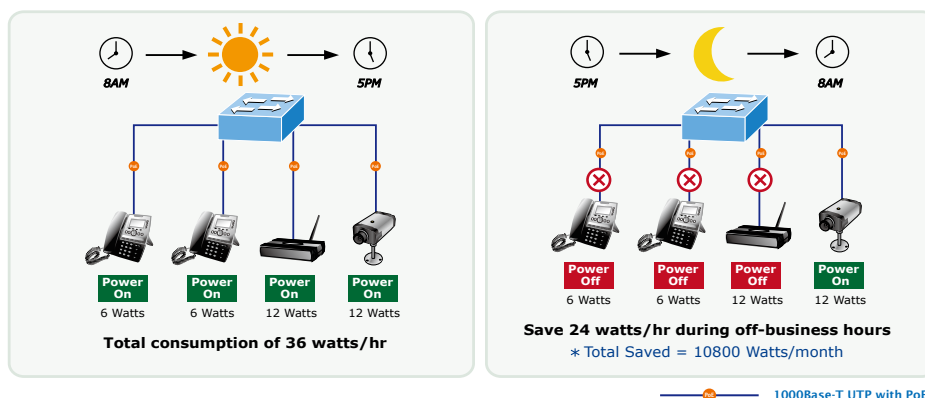

PoE Usage Monitoring

Via the power usage chart in the web management interface, the LRP-1622CS enables the administrator to monitor the status of the power usage of the connected PDs in real time. Thus, it greatly enhances the management efficiency of the facilities.

PoE Over-temperature Protection System

The over-temperature protection of the LRP-1622CS offers a safe and stable PoE operation by limiting the output power in order to avoid destructive breakdown due to unexpected overheating.

Environment-friendly, Smart Fan Design for Silent Operation

The LRP-1622CS features a 19-inch metal housing, a low noise design and an effective ventilation system. It supports the smart fan technology to automatically control the speed of the built-in fan to reduce noise and maintain the appropriate temperature of the PoE switch for optimal power output capability. The LRP-1622CS is able to operate reliably, stably and quietly in any environment without affecting its performance.

IPv6/IPv4 Dual Stack

Supporting both IPv6 and IPv4 protocols, the LRP-1622CS helps the SMBs to step in the IPv6 era with the lowest investment as its network facilities need not be replaced or overhauled if the IPv6 FTTx edge network is set up.

Robust Layer 2 Features

The LRP-1622CS can be programmed for advanced switch management functions such as dynamic port link aggregation, 802.1Q VLAN and Q-in-Q VLAN, Multiple Spanning Tree Protocol (MSTP), Loop and BPDU Guard, IGMP Snooping, and MLD Snooping. Via the link aggregation, the LRP-1622CS allows the operation of a high-speed trunk to combine with multiple ports such as an 8Gbps fat pipe, and supports fail-over as well. Also, the Link Layer Discovery Protocol (LLDP) is the Layer 2 Protocol included to help discover basic information about neighboring devices on the local broadcast domain.

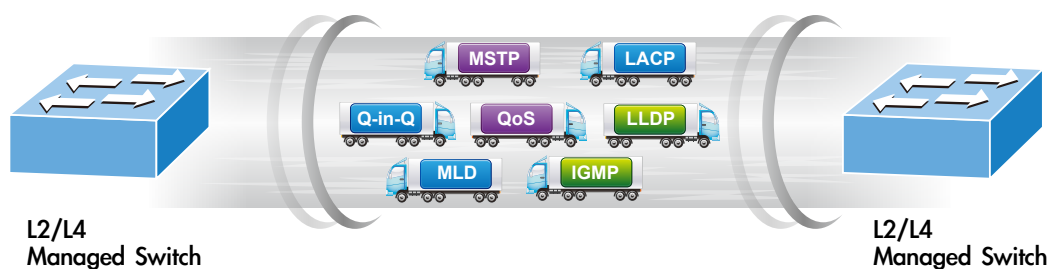

Efficient Traffic Control

The LRP-1622CS is loaded with robust QoS features and powerful traffic management to enhance services to business-class data, voice, and video solutions. The functionality includes broadcast/multicast storm control, per port bandwidth control, IP DSCP QoS priority and remarking. It guarantees the best performance for VoIP and video stream transmission, and empowers the enterprises to take full advantage of the limited network resources.

Powerful Security

PLANET LRP-1622CS offers comprehensive IPv4/IPv6 Layer 2 to Layer 4 Access Control List (ACL) for enforcing security to the edge. It can be used to restrict network access by denying packets based on source and destination IP address, TCP/UDP ports or defined typical network applications. Its protection mechanism also comprises 802.1X port-based user and device authentication, which can be deployed with RADIUS to ensure the port level security and block illegal users. With the Protected Port function, communication between edge ports can be prevented to guarantee user privacy. Furthermore, Port Security function allows to limit the number of network devices on a given port.

Advanced Network Security

The LRP-1622CS also provides DHCP Snooping, IP Source Guard and Dynamic ARP Inspection functions to prevent IP snooping from attack and discard ARP packets with invalid MAC address. The network administrators can now build highly-secured corporate networks with considerably less time and effort than before.

Friendly and Secure Management

For efficient management, the LRP-1622CS is equipped with console, Web, Telnet and SNMP management interfaces. With the built-in Web-based management interface, the LRP-1622CS offers an easy-to-use, platform-independent management and configuration facility. By supporting the standard Simple Network Management Protocol (SNMP), the switch can be managed via any standard management software. For text-based management, the switch can be accessed via Telnet and the console port. Moreover, the LRP-1622CS offers secure remote management by supporting SSH, SSL and SNMP v3 connections which encrypt the packet content at each session.

Flexibility and Long-distance Extension Solution

The LRP-1622CS provides two Gigabit TP interfaces supporting 10/100/1000BASE-T RJ45 copper to be connected with surveillance network devices such as NVR, Video Streaming Server or NAS to facilitate surveillance management. Or through another two dual-speed fiber SFP slots, it can connect with the 100BASE-FX/1000BASE-SX/LX SFP (Small Form-factor Pluggable) fiber transceiver to uplink to backbone switch and monitoring center in long distance. The distance can be extended from 550 meters to 2 kilometers (multi-mode fiber) and up to 10/20/30/40/50/70/120 kilometers (single-mode fiber or WDM fiber). The LRP-1622CS is well suited for applications within the enterprise data centers and distributions.

Intelligent SFP Diagnosis Mechanism

The LRP-1622CS also supports SFP-DDM (Digital Diagnostic Monitor) function that can easily monitor real-time parameters of the SFP for network administrator, such as optical output power, optical input power, temperature, laser bias current and transceiver supply voltage.

Applications

Long Reach PoE IP Surveillance Solution

The LRP-1622CS provides robust Long Reach PoE features to prevent network interruptions and extend the transmission of data and power via coaxial cable for up to 1km by working with the LRP-101CE Long Reach PoE Extender. It incorporates PLANET's new Long Reach PoE technology into customer's IP surveillance network to increase the distance of system transmission but to decrease the cost of installation. Applying the Long Reach Power over Ethernet functions in the LRP-1622CS, the LRP-101CE can directly connect with any IEEE 802.3at/af end-nodes like IP cameras. Furthermore, the power management of the IP camera system can be centrally controlled by the LRP-1622CS.

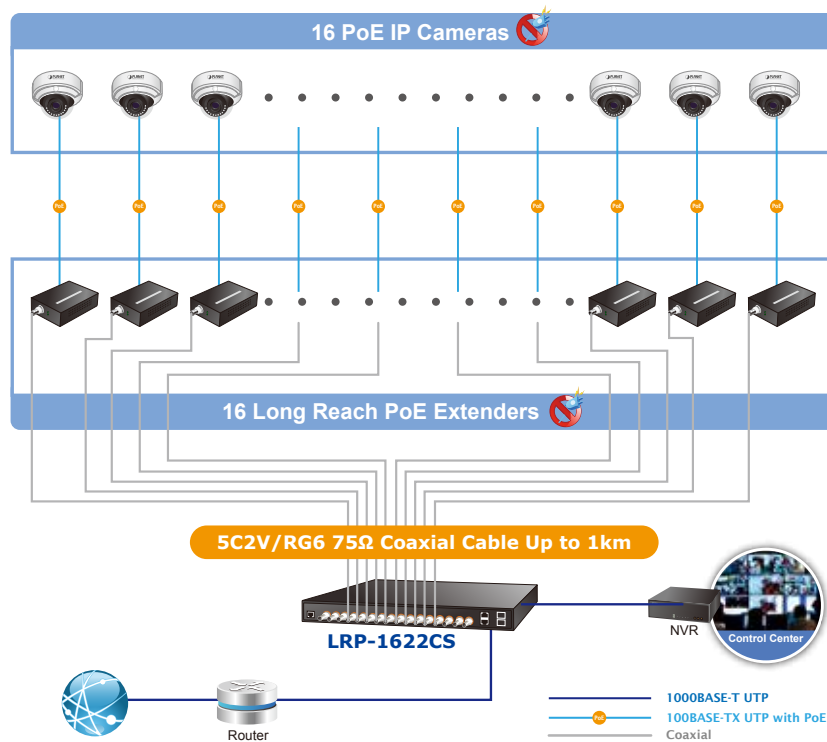

Highly-scalable Solution for Robotic Automation System

The LRP-1622CS brings network infrastructure higher flexibility but lower in cost. Providing 16 Fast Ethernet Long Reach PoE coaxial ports, two Gigabit TP ports and two Gigabit SFP slots, the LRP-1622CS can easily build a Long Reach Ethernet (LRE) networking area consisting of 1km coaxial cable on the robotic automation system for the factory. Obviously, the Long Reach PoE system also gives you the flexibility to expand small area network with BNC Tee Connector for sharing four nodes per port when needed.

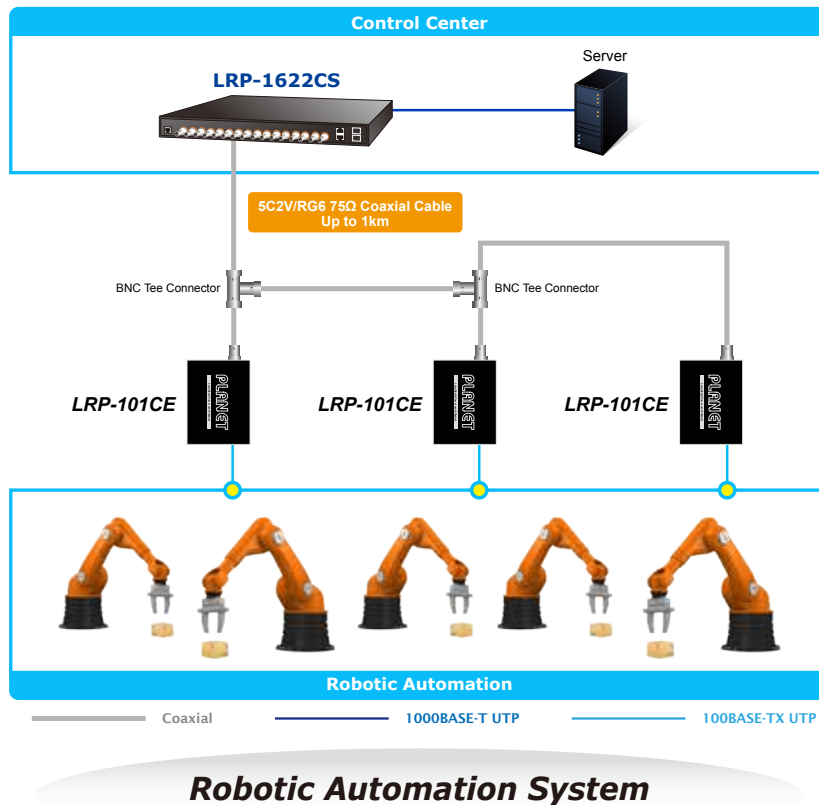

Specifications

| | | | | |
|--|------------------------------|---|------------|-------|
| Model | | LRP-1622CS | | |
| Hardware Specifications | | | | |
| Ethernet Interfaces | Copper | 2 x 10/100/1000BASE-T RJ45 Auto-negotiation/ Auto-MDI/MDI-X | | |
| | Fiber Optic | 2 x 100/1000BASE-X SFP slot Supports 100/1000Mbps dual mode and DDM | | |
| | Jumbo Frame | 10Kbytes with GE1 to GE4 | | |
| Long Reach PoE Interfaces | Connectivity | 16 x BNC female connectors Long Reach PoE over coaxial PSE (Power Source Equipment) – BNC center pole : DC+/Hi – BNC shield : DC -/Lo | | |
| | Power Output | Per port 52V DC, 36 watts (max.) | | |
| | Total Power Budget | 440 watts (max.) @ 25 degrees C 380 watts (max.) @ 50 degrees C | | |
| | Cabling | Coaxial cable: 75 ohm RG-6/U cable (Recommended) | | |
| | Maximum Distance | Max. 200m with PoE+ output (1,640ft.) Max. 400m with PoE output (2,624ft.) Max. 1200m without PoE output (3,937ft.) | | |
| | Long Reach Ethernet Standard | IEEE 1901 | | |
| | Modulation Type | Wavelet-OFDM | | |
| | Security | 128-bit AES encryption | | |
| | Frequency Band | 2 ~ 28MHz | | |
| | Performance | Distance | Data Rate* | |
| | | | TX** | RX** |
| 200m | | 74.8Mbps | 81.7Mbps | 19.8W |
| 400m | | 62.5Mbps | 75.2Mbps | 15.8W |
| 600m | | 57.8Mbps | 70.3Mbps | 11.8W |
| 800m | | 41.7Mbps | 67.1Mbps | 7.9W |
| 1000m | | 31.7Mbps | 58.8Mbps | 6.7W |
| 1200m | | 14.9Mbps | 22.5Mbps | --- |
| * The actual data rate and PoE output vary on the quality of the copper wire and environmental factors. The performance result above is based on the testing via the RG-6/U coaxial cable. | | | | |
| ** TX: The LRP-1622CS to the LRP-101CE RX: The LRP-101CE to the LRP-1622CS. | | | | |
| | Multiple Nodes | Up to 4 LRP extenders within 1km RG-6/U coaxial cable* * The actual extender nodes vary on the quality of the copper wire and environmental factors. | | |
| | LRP Compatibility | LRP-101CE: 1-Port 10/100TX PoE PSE + 1-Port Coax Long Reach PoE Extender | | |
| Console | | 1 x RS232-to-RJ45 serial port (115200, 8, N, 1) | | |
| Switch Architecture | | Store-and-Forward | | |
| Switch Fabric | | 11.2Gbps/non-blocking | | |
| Address Table | | 8K entries | | |
| Shared Data Buffer | | 4.1 megabits | | |
| Flow Control | | IEEE 802.3x pause frame for full-duplex Back pressure for half-duplex | | |
| Reset Button | | < 5 sec: System reboot > 5 sec: Factory default | | |
| LED | | PWR, SYS, LNK, PoE-in-Use, 1000, LNK/ACK, Fan 1 Alert, Fan 2 Alert, PoE PWR Alert | | |
| Dimensions (W x D x H) | | 440 x 300 x 44.5 mm, 1U height | | |
| Weight | | 4,430g | | |
| Power Requirements | | AC 100~240V, 50/60Hz, auto-sensing | | |
| ESD Protection | | 6KV DC | | |
| Power Consumption | | 540 watts/1843 BTU | | |
| Enclosure | | Metal | | |
| Layer 2 Functions | | | | |
| Port Mirroring | | TX/RX/both Many-to-1 monitor | | |

| | |
|------------------------------|--|
| VLAN | 802.1Q tagged-based VLAN Up to 256 VLAN groups, out of 4094 VLAN IDs 802.1ad Q-in-Q tunneling Voice VLAN Protocol VLAN Private VLAN (Protected port) GVRP |
| Link Aggregation | IEEE 802.3ad LACP and static trunk Supports 4 trunk groups with 4 ports for each group |
| Spanning Tree Protocol | STP/RSTP/MSTP |
| IGMP Snooping | IGMP (v2/v3) Snooping IGMP Querier Up to 256 multicast groups |
| MLD Snooping | MLD (v1/v2) Snooping, up to 256 multicast groups |
| Access Control List | IPv4/IPv6 IP-based ACL/MAC-based ACL |
| QoS | 8 mapping ID to 8 level priority queues - Port number - 802.1p priority - 802.1Q VLAN tag - DSCP field in IP packet Traffic classification based, strict priority and WRR |
| Security | IEEE 802.1X port-based authentication Built-in RADIUS client to co-operate with RADIUS server RADIUS/TACACS+ user access authentication IP-MAC port binding MAC filter Static MAC address DHCP Snooping and DHCP Option82 STP BPDU guard, BPDU filtering and BPDU forwarding DoS attack prevention ARP inspection IP source guard |
| Management Functions | |
| Basic Management Interfaces | Web browser / Telnet / SNMP v1, v2c Firmware upgrade by HTTP/TFTP protocol through Ethernet network Remote/Local Syslog System log LLDP protocol SNTP |
| Secure Management Interfaces | SSH, SSL, SNMP v3 |
| SNMP MIBs | RFC 1213 MIB-II RFC 1215 Generic Traps RFC 1493 Bridge MIB RFC 2674 Bridge MIB Extensions RFC 2737 Entity MIB (Version 2) RFC 2819 RMON (1, 2, 3, 9) RFC 2863 Interface Group MIB RFC 3635 Ethernet-like MIB |
| Standards Conformance | |
| Regulation Compliance | FCC Part 15 Class A, CE |
| Standards Compliance | IEEE 1901 Broadband Power Line IEEE 802.3 10BASE-T IEEE 802.3u 100BASE-TX/100BASE-FX IEEE 802.3z Gigabit SX/LX IEEE 802.3ab Gigabit 1000T IEEE 802.3x flow control and back pressure IEEE 802.3ad port trunk with LACP IEEE 802.1D Spanning Tree Protocol IEEE 802.1w Rapid Spanning Tree Protocol IEEE 802.1s Multiple Spanning Tree Protocol IEEE 802.1p Class of Service IEEE 802.1Q VLAN tagging IEEE 802.1X Port Authentication Network Control IEEE 802.1ab LLDP RFC 768 UDP RFC 793 TFTP RFC 791 IP RFC 792 ICMP RFC 2068 HTTP RFC 1112 IGMP version 1 RFC 2236 IGMP version 2 RFC 3376 IGMP version 3 RFC 2710 MLD version 1 RFC 3810 MLD version 2 |
| Environment | |
| Operating | Temperature: 0 ~ 50 degrees C Relative Humidity: 5 ~ 95% (non-condensing) |
| Storage | Temperature: -10 ~ 70 degrees C Relative Humidity: 5 ~ 95% (non-condensing) |

Ordering Information

| | |
|------------|--|
| LRP-1622CS | 16-port Coax + 2-port 10/100/1000T + 2-port 100/1000X SFP Long Reach PoE over Coaxial Managed Switch |
|------------|--|

Related Products

| | |
|-----------|---|
| LRP-822CS | 8-port Coax + 2-port 10/100/1000T + 2-port 100/1000X SFP Long Reach PoE over Coaxial Managed Switch |
| LRP-101CE | 1-port 10/100TX PoE PSE + 1-port Coax Long Reach PoE Extender |

Available Modules

| | |
|----------|--|
| MGB-GT | SFP-port 1000BASE-T Module |
| MGB-SX | SFP-port 1000BASE-SX mini-GBIC module - 220/550m |
| MGB-LX | SFP-port 1000BASE-LX mini-GBIC module - 10km |
| MGB-L30 | SFP-port 1000BASE-LX mini-GBIC module - 30km |
| MGB-L50 | SFP-port 1000BASE-LX mini-GBIC module - 50km |
| MGB-L70 | SFP-port 1000BASE-LX mini-GBIC module - 70km |
| MGB-L120 | SFP-port 1000BASE-LX mini-GBIC module - 120km |
| MGB-LA10 | SFP-port 1000BASE-LX (WDM,TX:1310nm) mini-GBIC module - 10km |
| MGB-LB10 | SFP-port 1000BASE-LX (WDM,TX:1550nm) mini-GBIC module - 10km |
| MGB-LA20 | SFP-port 1000BASE-LX (WDM,TX:1310nm) mini-GBIC module - 20km |
| MGB-LB20 | SFP-port 1000BASE-LX (WDM,TX:1550nm) mini-GBIC module - 20km |
| MGB-LA40 | SFP-port 1000BASE-LX (WDM,TX:1310nm) mini-GBIC module - 40km |
| MGB-LB40 | SFP-port 1000BASE-LX (WDM,TX:1550nm) mini-GBIC module - 40km |

Available 100Mbps Modules

| | |
|----------|--|
| MFB-FX | SFP-port 100BASE-FX Transceiver (1310nm) - 2km |
| MFB-F20 | SFP-port 100BASE-FX Transceiver (1310nm) - 20km |
| MFB-F40 | SFP-port 100BASE-FX Transceiver (1310nm) - 40km |
| MFB-F60 | SFP-port 100BASE-FX Transceiver (1310nm) - 60km |
| MFB-FA20 | SFP-port 100BASE-BX Transceiver (WDM,TX:1310nm) - 20km |
| MFB-FB20 | SFP-port 100BASE-BX Transceiver (WDM,TX:1550nm) - 20km |