



Version: V1.00.000
Revision Date: 11-11-2020

Statement: LAUNCH owns the complete intellectual property rights for the software used by this product. For any reverse engineering or cracking actions against the software, LAUNCH will block the use of this product and reserve the right to pursue their legal liabilities.

Copyright Information

Copyright © 2020 by LAUNCH TECH CO., LTD. All rights reserved. No part of this publication may be reproduced, stored in a retrieval system, or transmitted in any form or by any means, electronic, mechanical, photocopying, recording or otherwise, without the prior written permission of LAUNCH. The information contained herein is designed only for the use of this unit. LAUNCH is not responsible for any use of this information as applied to other units.

Neither LAUNCH nor its affiliates shall be liable to the purchaser of this unit or third parties for damages, losses, costs, or expenses incurred by purchaser or third parties as a result of: Accident, misuse, or abuse of this unit, or unauthorized modifications, repairs, or alterations to this unit, or failure to strictly comply with LAUNCH operating and maintenance instructions. LAUNCH shall not be liable for any damages or problems arising from the use of any options or any consumable products other than those designated as Original LAUNCH Products or LAUNCH Approved Products by LAUNCH.

Trademark Information

LAUNCH is a registered trademark of LAUNCH TECH CO., LTD. (LAUNCH) in China and other countries. All other LAUNCH trademarks, service marks, domain names, logos, and company names referred to in this manual are either trademarks, registered trademarks, service marks, domain names, logos, company names of or are otherwise the property of LAUNCH or its affiliates. In countries where any of the LAUNCH trademarks, service marks, domain names, logos and company names are not registered, LAUNCH claims other rights associated with unregistered trademarks, service marks, domain names, logos, and company names. Other products or company names referred to in this manual may be trademarks of their respective owners. You may not use any trademark, service mark, domain name, logo, or company name of LAUNCH or any third party without permission from the owner of the applicable trademark, service mark, domain name, logo, or company name. You may contact LAUNCH by visiting the website at www.cnlaunch.com, or writing to LAUNCH TECH CO., LTD., Launch Industrial Park, North of Wuhe Avenue, Banxuegang, Bantian, Longgang, Shenzhen, Guangdong, P.R.China, to request written permission to use Materials on this manual for purposes or for all other questions relating to this manual.

Important safety and operation information

To avoid personal injury, property loss, or accidental damage to the product, please read all the information in this section before using the product.

Handle device carefully.

Do not drop, bend, puncture, insert foreign objects, or place heavy objects on the device. The inside fragile components may be damaged.

Connect and Disconnect Properly.

Do not connect or disconnect probes or test leads while they are connected to a voltage source.

Observe All Terminal Ratings.

To avoid fire or shock hazard, observe all ratings and markings on the product. Consult the product manual for further ratings information before making connections to the product.

Use Proper Probe.

To avoid shock hazard, use a properly rated probe for your measurement.

Avoid Circuit or Wire Exposure.

Do not touch exposed connections and components when power is on.

Do Not Operate With Suspected Failures.

If suspected damage occurs with the device, have it inspected by qualified service personnel before further operations.

Do not operate in Wet/Damp Conditions.**Do not operate in an Explosive Atmosphere.****Keep product surfaces Clean and Dry.****Do not disassemble or refit the device.**

The device is a sealing device and there are no end-user serviceable parts inside. All internal repairs must be carried out by authorized maintenance agencies or authorized technicians. Attempts to disassemble or refit the device will void the warranty.

Do not try to replace the internal battery.

The internal rechargeable battery must be replaced by authorized maintenance agencies or authorized technicians.

Precautions for vehicle ECU operation

When performing diagnostic operations on a vehicle equipped with the ECU, pay attention to the following items:

- When the ignition switch is turned on, the vehicle internal electrical units must not be disconnected. Otherwise, a high instantaneous voltage will be generated due to the self-inductance of the coil, which will cause damage to the sensor and ECU.
- Do not place magnetic objects such as radio speakers close to the computer, because the speaker magnets can damage the circuits and components in the ECU.
- Do disconnect the ECU system power supply when welding on the vehicle.
- When performing repair work near a computer or sensor, pay more attention to avoiding damage to the ECU and sensor.

- Ground yourself when you disassemble the programmable ROM. Otherwise, ECU circuits can be damaged by static electricity.
- Unless otherwise specified in the test procedure, the ECU and sensor should not be tested with a pointer ohmmeter, but with a high-impedance digital meter.
- Do not use test lamps to test ECU related electrical units in order to prevent ECU or sensor damage, unless otherwise noted.
- When people enter or exit the vehicle, the electrostatic discharge of human body can generate a high voltage of up to 10000V. Therefore, when performing maintenance operations on the digital meter controlled by the ECU or near this meter, be sure to wear a grounded metal strap with one end around the wrist and the other end clamped on the vehicle body.
- Reliably connect the ECU harness connector to avoid damage to the electronic components such as the integrated circuits inside the ECU.

FCC Statement

This device complies with Part 15 of the FCC Rules. Operation is subject to the following two conditions: (1) This device may not cause harmful interference, and (2) this device must accept any interference received, including interference that may cause undesired operation.

CONTENTS

1 INTRODUCTION	1
1.1 PRODUCT INTRODUCTION	1
1.2 ACCESSORY INCLUDED	1
1.3 TECHNICAL PARAMETERS	3
2 COMPONENTS & CONTROLS	5
3 INITIAL USE	6
3.1 GETTING STARTED	6
3.2 PROBE COMPENSATION	9
3.3 SELF-CALIBRATION	11
3.4 CONNECTION	12
4 OPERATIONS	15
4.1 CHANNEL SELECTION	15
4.2 CHANNEL ATTRIBUTES & TRIGGER SETTING	15
4.2.1 Horizontal Settings	16
4.2.2 Vertical Settings	16
4.2.3 Trigger Setting	17
4.3 AUTO-SET	19
4.4 MENU OPERATIONS	19
4.4.1 Measure	19
4.4.2 Save	21
4.4.3 Display	21
4.4.4 Trigger	22
4.4.5 Userset	22
4.4.6 About	23
4.5 ZOOM	23
4.6 CURSOR OPERATIONS	23
4.7 QUICK SAVE	24
4.8 AUTOMOTIVE OPERATIONS	24
4.9 MATH & REF	25
4.9.1 MATH	25
4.9.2 REF	26
4.10 PHASE RULER	27
5 IGNITION	28
5.1 SECONDARY-DISTRIBUTOR IGNITION ANALYSIS	28
5.2 SECONDARY-SIMULTANEOUS IGNITION ANALYSIS	29
5.3 SECONDARY-DIRECT IGNITION ANALYSIS	31
5.4 WAVEFORM ANALYSIS MODE	32
6 CARE & MAINTENANCE	36

1 Introduction

1.1 Product Introduction



The Scopebox is an optional add-on module, including automotive oscilloscope and automotive ignition waveform.



Automotive oscilloscope can make the auto repair technician quickly judge the faults on automotive electronic equipment and wiring, and the oscilloscope sweep speed is far greater than the signal frequency of such vehicles, usually 5-10 times of the measured signal. The automotive oscilloscope not only can quickly acquire the circuit signal, but also can slowly display the waveform to observe and analyze. It can also record and store the tested signal waveform which can be recalled to observe for the fast signal, having great convenience to failure analysis. Either high-speed signal (e.g.: Injection nozzle, intermittent fault signal) or the slow-speed signal (e.g. the throttle position change and the oxygen sensor signal) can be observed through automotive oscilloscope in an appropriate waveform.





The electronic signal can be compared and judged via measuring five parameters indexes. The five parameters are the amplitude (the maximum voltage of signal), the frequency (the cycle time of signal), the shape (the appearance of signal), the pulse width (the duty cycle or the time range of signal), and the array (the repetition characteristic of signal), which can be tested, displayed, saved by the automotive oscilloscope. Via the waveform analysis can further detect the circuit fault on sensors, actuators, circuits, and electronic control units, etc.

1.2 Accessory Included

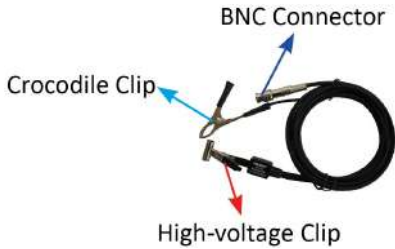
Common accessories are same, but for different destinations, the accessories may vary. Please consult from the local agency or check the package list supplied with this tool together.

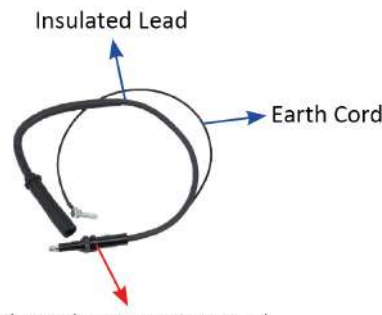
No.	Name	Picture
1	BNC to 4mm Test Leads	 <p data-bbox="719 1442 1385 1666">Test lead of a male BNC connector to (2) 4mm connectors. It is a kind of special line for assisting the Scopebox to test various types of signals. 4mm connectors are coded in two colors: black (earth wire) and red (positive pole which should be connected with the 6-way Breakout Leads). Moreover, it can also work with the 20:1 Attenuator.</p>
2	6-way Breakout Leads	 <p data-bbox="719 1874 1374 2018">Each lead has 6 blades wired to 6 sockets, allowing you to insert it between a plug and socket pair, other ends are 6 (4 mm) sockets which can be connected to the BNC to 4mm Test Lead.</p>

		<p>With these 6-way leads, you will be able to test most of the sensors and actuators on all makes and models of vehicle, including MAP, temperature, throttle position and airflow sensors, fuel pumps, primary ignition circuits and fuel injectors.</p>
3	USB cable	 <p>Connects the Scopebox and diagnostic tool so that the sampled signal can be displayed on the diagnostic tool.</p>
4	Battery clamps cable	 <p>To supply power to the Scopebox through connection to vehicle's battery.</p>
5	20:1 Attenuator	 <p>It allows the Scopebox to measure fuel injector and primary ignition waveforms.</p> <p>*Note: Please note this attenuator should be not used for any high voltage measurements other than fuel injectors and primary ignition.</p>
6	Secondary ignition pick-up	 <p>This ignition pick-up is applied in the following situations: Secondary-distributor ignition analysis, Secondary-simultaneous ignition analysis and Secondary-direct ignition analysis.</p> <p>It has three ends: BNC connector (for connecting to CH1/CH2/CH3/CH4), crocodile clip (for Grounding) and high-voltage clip (for connecting high-voltage line), near which has an attenuator equipped for high-pressure attenuation to prevent the Scopebox from being impacted.</p> <p>*Notes:</p> <ol style="list-style-type: none"> 1). The high voltage clip should be clamped on the insulated lead (COP Extension Cord, see Item 8) instead of on the spark plug to prevent breakdown and electric shock.

		2). Please try to keep an instance of 2 inch from other high-voltage line to avoid the interference.
7	COP (Coil-on-Plug) Extension Cord	 <p>Coil-on-Plug extension cord (including earth cord) allows you to take accurate secondary ignition measurements on secondary-direct (Coil-on-Plug) ignition systems. It can be applied in the condition that there are no, or limited access to any spark plug leads.</p>
8	Multimeter probes	
9	Crocodile clips	 <p>Designed to connect the bare terminals or leads.</p>
10	Back Probe Pins Suite	 <p>They are mainly used for piercing the insulation of wires to allow for automotive electrical measurements without causing damage to the wires. Additionally they can be used as pin-tip probes while working with small circuit boards.</p>

1.3 Technical Parameters

Item	Range
Channels	4
Bandwidth	100MHz
Rising time	≤3.5ns(typical)
Max. sample rate	1Gbps(for four channels)

Input impedance	1M Ω \pm 1.5%
Storage depth	50M(for four channels)
Sample bit	8bit
Horizontal precision	3%
Horizontal scale	5mV~10V
Horizontal offset range	\pm 2.5V(in case of probe switch "x1", <500mV/div), \pm 120V(in case of probe switch "x1", \geq 500mV/div)
Invert	Support
Coupling	DC, AC
Timebase	50ns~1ks (1 channel), 100ns~1ks (2 channels), 200ns~1ks (4 channels)
Timebase precision	20ppm
Acquisition mode	Normal
Line decoding	CAN, LIN
Trigger type	Edge, Pulse width
Trigger mode	Normal, Auto and Single SEQ
Trigger Coupling	DC, Noise rejection
Display	YT、Zoom、Roll
Roll mode	200ms/div~1000s/div
Auto set	Support
Auto measure	23
Cursor	Horizontal cursor, Vertical cursor
Power interface	USB port, DC IN port
Data exchange via	USB
Compatible operating system	Android
Automotive	Circuits, sensor, actuators, ignition
Working temperature	0 $^{\circ}$ C~50 $^{\circ}$ C
Storage temperature	-30 $^{\circ}$ C~70 $^{\circ}$ C

2 Components & Controls

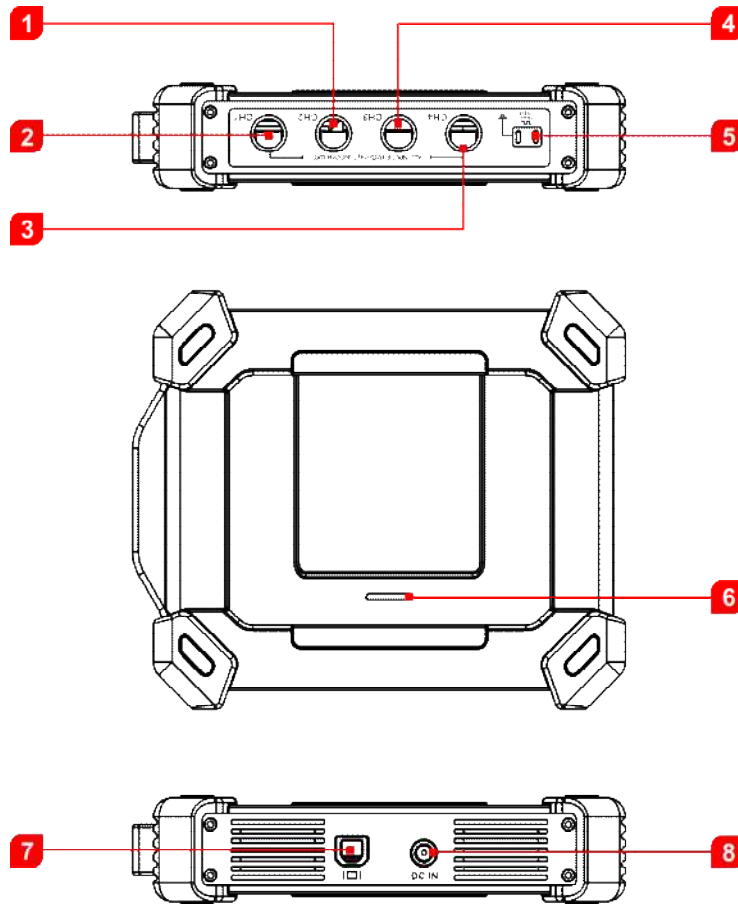

No.	Name	Description
1	CH2	Channel 2
2	CH1	Channel 1
3	CH4	Channel 4
4	CH3	Channel 3
5	Fixed signal generator	Generate a square signal with fixed 1K frequency.
6	Working LED	<ul style="list-style-type: none"> It illuminates solid green when it is powered up. It flashes when it is communicating with the diagnostic tool. If an error occurs, it will flash more quickly.
7	B-shaped USB Port	Connect to the diagnostic tool via USB cable so that the signal can be displayed on the tool.
8	DC IN port	To provide power to it via the battery clamps cable.







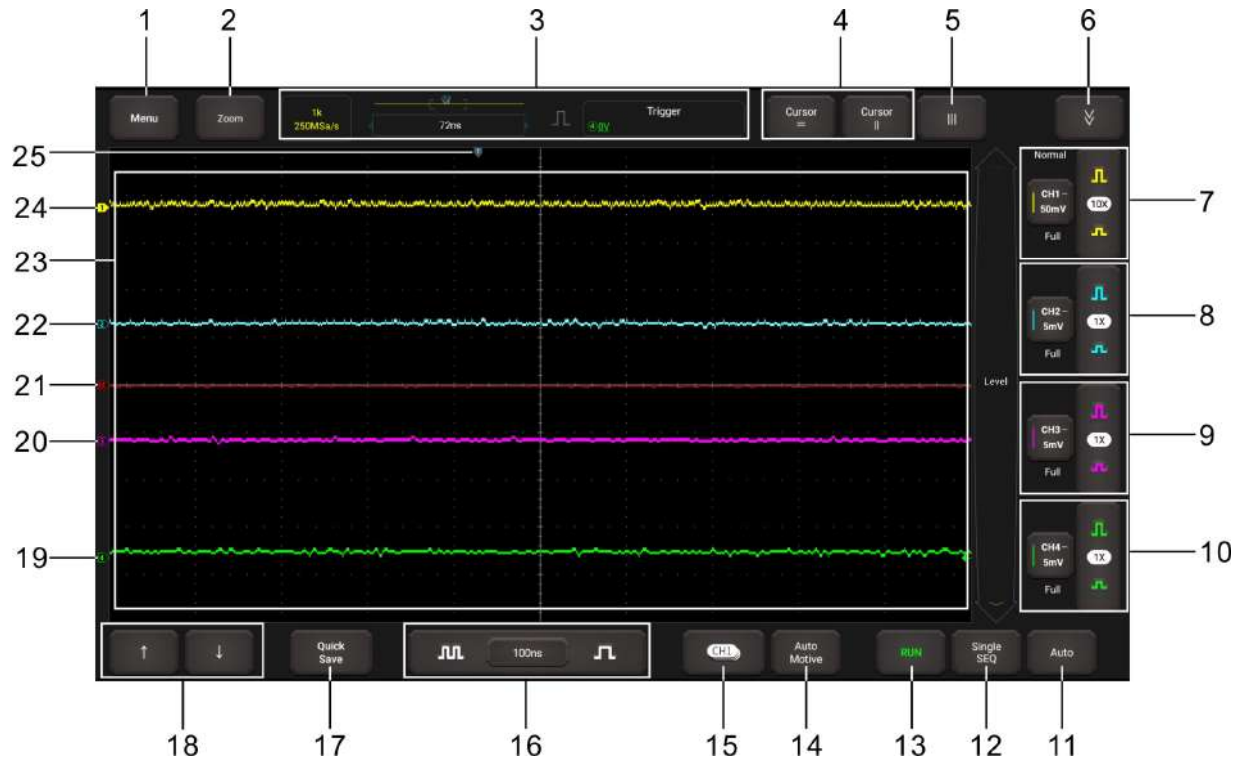



3 Initial Use





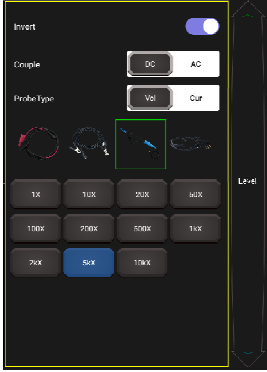

3.1 Getting Started

















Tap the application icon to launch it, the following screen will appear:



No.	Descriptions	Operation tips
1	<p>Menu</p> <p>It includes the following options:</p> <ul style="list-style-type: none"> • Measure: It provides 23 parametric measurement items. • Save: It allows you to save the current setup before you close the software. • Display: Sets the display mode of the waveform. • Trigger: In this panel, the user can change the trigger mode, sweep, source and slope. • Userset: The following items are available: storage depth, factory reset, self-adjust (self-calibration) and save & recovery. • About: Displays the detailed information of the app. 	<p>Tap this button once to enter the submenu. Tap it again to fold the submenu.</p> <p>For detailed operations on the submenus, refer to Chapter 4.4.</p>
2	<p>Zoom</p> <p>The user can change the waveform display by adjusting the scale and position. When you change the scale, the waveform display will increase or decrease in size. When you change the position, the waveform will move up,</p>	<p>Tap this button once to enter the submenu. Tap it again to fold the submenu.</p>

	down, right, or left.	
3	<p>Trigger information of the current channel</p> <p>Readouts indicate the storage depth, sample rate, cursor position indicator and trigger information.</p>	It shows the working status and cannot be adjusted by tapping it directly.
4	<p> Cursor settings</p> <p>Turn on/off the horizontal/vertical cursor measurement function. When set to ON, two horizontal/vertical reference lines named with Y1 & Y2/X1 & X2 will be displayed on the waveform display area. The user can use  or  to fine tune the line or drag the line directly to move it.</p>	Tap this button once to start the cursor calculation function. Tap it again to disable it.
5	<p> Phase ruler</p>	Tap this button once to activate it. Tap it again to exit. See Chapter 4.10 for details.
6	<p> More channel settings</p> <p>Sets more channels. It includes: MATH, REF, S1 LIN and S2 LIN.</p>	Tap this button once to enter the submenu. Tap it again to fold the submenu.
7	<p>Channel 1 Vertical Settings Panel</p> <p>Controls the amplitude of the displayed signal. User can change Invert, coupling and probe attenuation of the CH1.</p>	Take Channel 2 for example to explain how to operate the vertical setting panel. Tap  once – turns on the channel and sets it as the current channel.
8	<p>Channel 2 Vertical Settings Panel</p> <p>Controls the amplitude of the displayed signal. User can change Invert, coupling and probe attenuation of the CH2.</p>	 Tap  twice – Calls out the channel vertical settings.
9	<p>Channel 3 Vertical Settings Panel</p> <p>Controls the amplitude of the displayed signal. User can change Invert, coupling and probe attenuation of the CH3.</p>	
10	<p>Channel 4 Vertical Settings Panel</p> <p>Controls the amplitude of the displayed signal. User can</p>	

	change Invert, coupling and probe attenuation of the CH4.	Tap  for three times - turns off the channel. 
11	Auto It automatically adjusts the vertical scale, horizontal scale and trigger settings.	Tap this button to start auto-set.
12	Single SEQ In this mode, it only acquires the waveform that generates for the first time the trigger conditions are met, and then stops after finishing capture.	
13	RUN/STOP/WAIT <ul style="list-style-type: none"> • WAIT: All pre-triggered data has been acquired and the Scopebox is ready to accept a trigger. • STOP: The Scopebox has stopped acquiring waveform data. • RUN: The Scopebox is running. 	
14	Automotive Provides all kinds of the testing applications on the automotive parts (including circuits, sensors, actuators, ignition etc.) and detailed connection methods.	Tap this button once to enter the submenu. Tap it again to fold the submenu.
15	 Channel selection button Tap it to select the desired channel.	Tap this button once, the channel (only the channels that have been turned on) selection pop-up will appear. Tap it again to fold the submenu.
16	Horizontal settings Controls the time base.	Tap this button once to enter the submenu. Tap it again to fold the submenu.
17	Quick Save Quickly saves the waveforms of all channels as the reference waveforms and capture the current screen as screenshots. To change the save path and file type, go to Menu -> Save .	
18	 or  Fine-tuning button Fine tunes the vertical/horizontal reference line.	When the horizontal cursor is ON, the fine tuning buttons display  and  . If the vertical cursor is ON, the fine tuning buttons will

		change into  and  .
19	CH4 marker Shows the reference points of the displayed waveforms. If there is no marker, the channel is not displayed.	If the marker is displayed as  , it indicates the channel is not the current channel. Tap the marker  , it will change into  , it indicates the channel is the current channel.
20	CH3 marker Shows the reference points of the displayed waveforms. If there is no marker, the channel is not displayed.	If the marker is displayed as  , it indicates the channel is not the current channel. Tap the marker  , it will change into  , it indicates the channel is the current channel.
21	Math marker Shows the reference points of the displayed waveforms. If there is no marker, the channel is turned off and not displayed.	The MATH channel is hidden under the  tab.
22	CH2 marker Shows the reference points of the displayed waveforms. If there is no marker, the channel is not displayed.	If the marker is displayed as  , it indicates the channel is not the current channel. Tap the marker  , it will change into  , it indicates the channel is the current channel.
23	Waveform display area	
24	CH1 marker Shows the reference points of the displayed waveforms. If there is no marker, the channel is not displayed.	If the marker is displayed as  , it indicates the channel is not the current channel. Tap the marker  , it will change into  , it indicates the channel is the current channel.
25	 Horizontal trigger position marker	

3.2 Probe Compensation

Perform this function to match the characteristics of the probe (optional) and the channel input. The probe that has not been compensated may cause measurement tolerance or error.

1. Power the Scopebox on: Power is provided to the Scopebox in either of the following ways:

- **Battery clamps cable:** Plug one end of the power adaptor into the DC-IN port of the Scopebox, and then clamp the other two terminals to the vehicle's battery (Red to +, and Black to -) respectively.



Note: This connection only applies to the condition that the diagnostic tool cannot provide enough power to the Scopebox via USB cable.

- **USB cable (optional):** Insert one end of the power adaptor into the Power interface of the Scopebox,

and the other end to the AC outlet.

 Note: This connection only applies to the condition that the diagnostic tool can supply enough power to the Scopebox directly via USB cable.

2. Connect the B-shaped plug of the USB cable to the USB port of the Scopebox, and the other end to the USB port of the diagnostic tool.
3. Launch the OS2-1 Scopebox App to run it.
4. From the "Vertical Setting" panel, select the corresponding channel and set the Probe attenuation to **10X**.

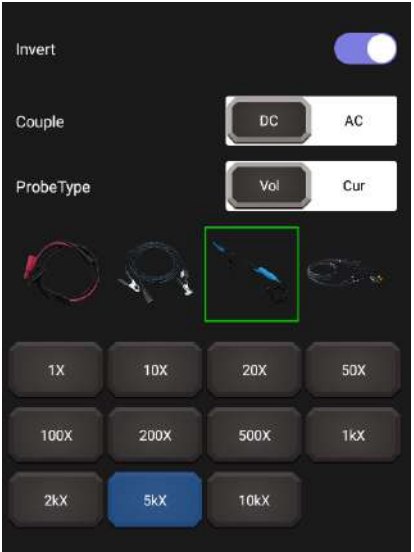
	Settings	Corresponding attenuation proportion
	1x	1:1
	10x	10:1
	20x	20:1
	50x	50:1
	100x	100:1
	200x	200:1
	500x	500:1
	1kx	1000:1
	2kx	2000:1
	5kx	5000:1
	10kx	10000:1

5. Set the switch to "X10" (the default is X1) on the probe and connect it to the CH1 of the Scopebox.
6. Attach the probe tip to the Probe Compensator and the ground nip of the reference lead to the ground connector. When using the probe hook-tip, insert the tip onto the probe compensator firmly to ensure a proper connection.

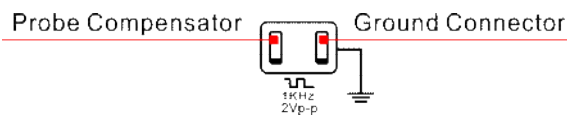



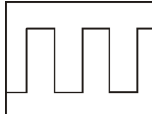

7. Tap the **Auto** button located on the bottom of the screen, a square wave (approximately 1kHzm 2V peak-to-peak) will be displayed within several seconds.

 Note: The above steps also can be applied to check whether the signal input/output of other Channels are normal or not.

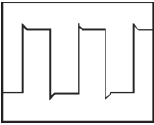
8. Check the shape of the displayed waveform to determine whether the probe is correctly compensated.

Correctly Compensated		
-----------------------	---	--

Over Compensated		<p> Note: If necessary, use a non-metallic tool to adjust the trimmer capacitor of the probe for the fattest square wave being displayed on the Scopebox.</p>
Under Compensated		

 Warning: To avoid electric shock while using the probe, make sure the insulated cable is perfect, and do not touch the metallic portions of the probe head while it is connected with a high-voltage source.

9. Inspect CH2 ,CH3 and CH4 with the same method.

3.3 Self-Calibration

The self-calibration routine lets you optimize the oscilloscope signal path for maximum measurement accuracy. You can run the routine at any time but you should always run the routine if the ambient temperature changes by 10°C or more.

For accurate calibration, power on the Scopebox and wait twenty minutes to ensure it is warmed up.

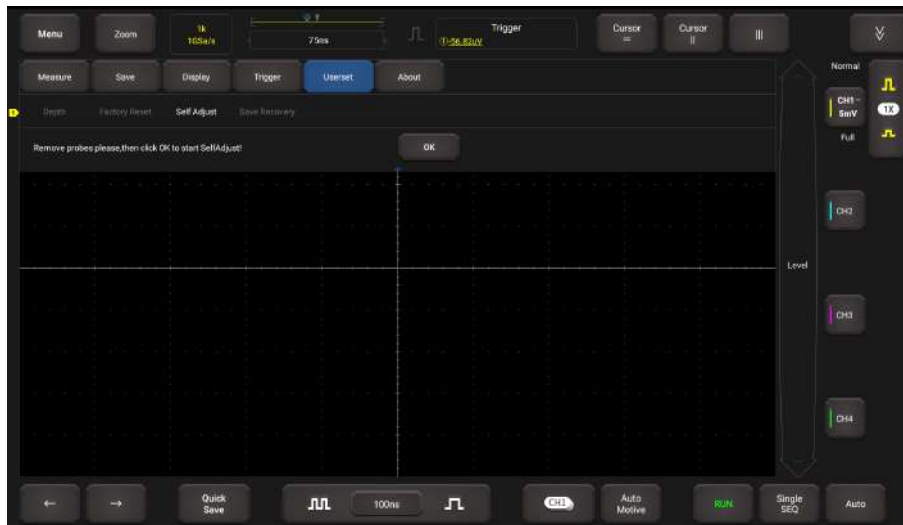

 Note: To compensate the signal path, disconnect any probes or cables from the input connectors.

Then, access **Menu -> Userset**, tap **Self Adjust**.



Tap **OK** on the pop-up message box to start calibration. The LED on the Scopebox starts flashing and the prompt message “Self Adjust is running” will appear on the upper left corner of the screen.



 Note: While calibrating, a lock icon  will appear on the upper right corner of the screen. In this case, no operations are allowed to perform until the calibration process is successfully finished. After the calibration is complete, the lock icon will disappear.

The self-calibration routine takes about several minutes. After calibration is complete, the prompt message “Self Adjust is successful” will pop up on the screen.

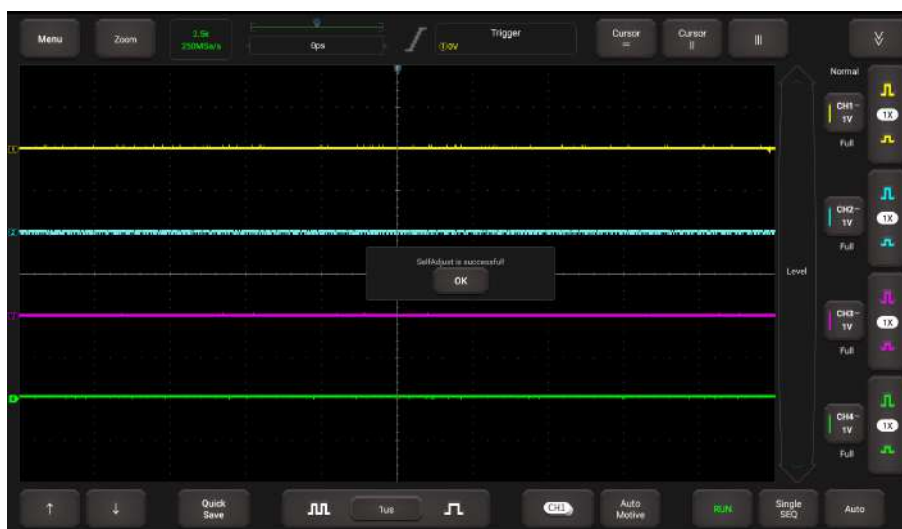

Tap **OK** to finish the self-calibration.

3.4 Connection

For different applications, the connection methods may vary.

1. Power the Scopebox on: Power is provided to the Scopebox in either of the following ways:

- **Battery clamps cable:** Plug one end of the power adaptor into the DC-IN port of the Scopebox, and then clamp the other two terminals to the vehicle's battery (Red to +, and Black to -) respectively.

 Note: This connection only applies to the condition that the diagnostic tool cannot provide enough power to the Scopebox via USB cable.

- **USB cable (optional):** Insert one end of the power adaptor into the Power interface of the Scopebox, and the other end to the AC outlet.

 Note: This connection only applies to the condition that the diagnostic tool can supply enough power to the Scopebox directly via USB cable.

2. Connect the B-shaped plug of the USB cable to the USB port of the Scopebox, and the other end to the USB port of the diagnostic tool.

A. While testing sensors or actuators.

3. Connect the BNC connector of the BNC to 4mm test lead to the CH1/CH2/CH3/CH4, and plug the black (GND) and red (SIGNAL) 4mm connectors into the Black (GND) and other color (SIGNAL) banana sockets of the 6-way breakout leads respectively.

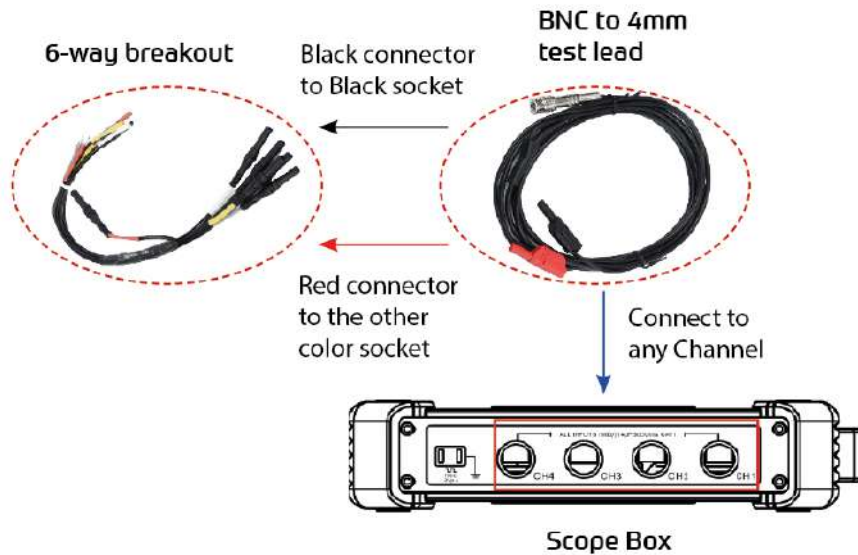

4. Connect the black terminal and signal wire (its other end connected to the red 4mm connector) of the 6-way breakout lead to the GND and signal terminal of the vehicle sensor.

B. While testing Secondary-distributor ignition analysis/Secondary-simultaneous ignition analysis.

3. Connect the BNC connector of the secondary ignition pick-up to any channel of the Scopebox, and clamp the crocodile clips and high-voltage clips onto the vehicle ground and high-voltage line respectively.

The connection is as follows:

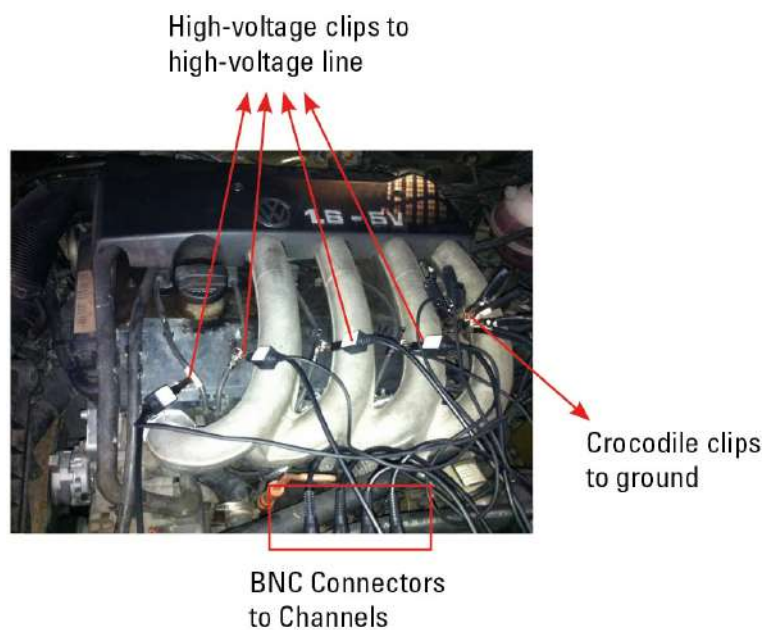

For detailed operations, please refer to Chapter 5.

C. While testing Secondary-direct ignition analysis.

3. *When the high-voltage wire is exposed*, plug the BNC end of secondary ignition pickup into CH1/CH2/CH3/CH4 channel of Scopebox, then connect the high-voltage clip to high-voltage line, and crocodile clips to ground.
4. *If no high-voltage wire is exposed*, dismantle ignition coil of tested cylinder. Connect one end of the COP extension cord to the ignition coil which should be grounded via COP earth cord, and insert the other end into the cylinder to joint with spark plug. Then plug the BNC end of secondary ignition pickup into CH1/CH2/CH3/CH4 channel of Scopebox, and then connect the high-voltage clip to high-voltage line, and crocodile clips to ground.

The connection is as follows:

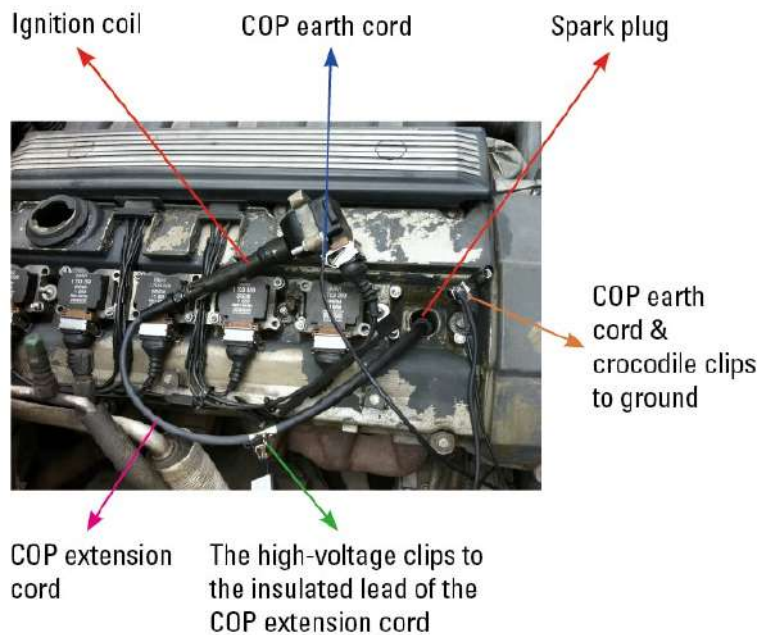







For detailed operations, please refer to Chapter 5.

4 Operations

4.1 Channel Selection

Total 6 channels are available. By default 4 channels (CH1, CH2, CH3 and CH4) are displayed on the right side of the screen. MATH and REF are rarely used and folded, which can be called out by tapping .

Follow the methods to select a channel:



Select CH1/CH2/CH3/CH4	Select Channel MATH/REF
<p>There are two methods for your opt:</p> <p>A. Tap the channel tab shown on the right edge of the screen.</p>  <p>B. Tap  to select the desired channel. In this mode, only the channels that are turned on can be selected.</p> <p> Note: For better comparison and identification, each channel and waveform are marked in different colors.</p>	<p>Tap .</p>  <p> Note: For detailed operations on the Channel MATH and REF, refer to Chapter 4.9.</p>

The Scopebox can display multiple waveforms simultaneously, but only one waveform is allowed to display at top. The toppest channel is called current channel. The marker of the current channel is displayed as , otherwise it is non-current channel.



4.2 Channel Attributes & Trigger Setting

Channel attributes can be set via horizontal settings and vertical settings.

4.2.1 Horizontal Settings

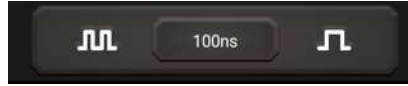
User can change the horizontal time/division scale by tapping  or  directly or by tapping the time/division value to select it from the pull-down list.



If the waveform acquisition is stopped, the time/division selector (/) expands or compresses the waveform.

4.2.2 Vertical Settings

The trigger determines when the Scopebox starts to acquire data and display a waveform. When a trigger is set up properly, it can convert unstable displays or blank screens into meaningful waveforms.

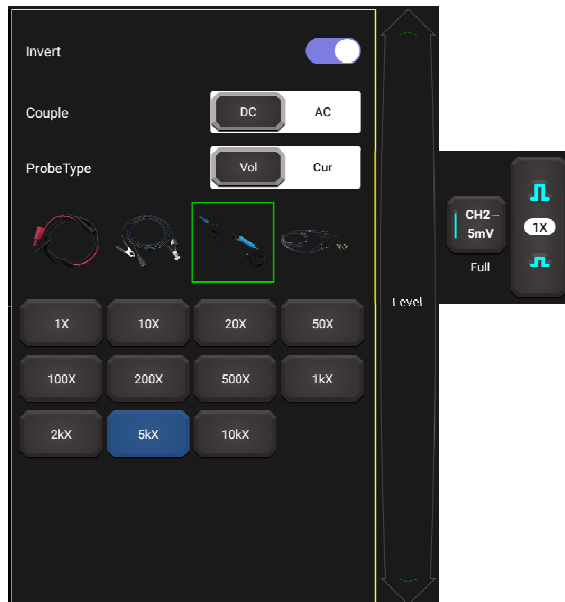

When the Scopebox starts to acquire a waveform, it collects enough data so that it can draw the waveform to the left of the trigger point. The Scopebox continues to acquire data while waiting for the trigger condition to occur. After it detects a trigger, the Scopebox continues to acquire enough data so that it can draw the waveform to the right of the trigger point.

Tap certain channel to call out the vertical setting option.



Options descriptions:

Menu	Comments/Settings
Invert	<u>ON</u> : Turn on the invert function. <u>OFF</u> : Restore to the original display of the waveform.
Couple	Trigger coupling determines what part of the signal passes to the trigger circuit. AC and DC are included: <u>AC</u> : Blocks the DC component of the input signal. <u>DC</u> : Passes both AC and DC components of the input signal.
Probe Type	Choose the probe type. Vol and Cur are included: <u>Vol</u> : Voltage probe. <u>Cur</u> : Current probe. After choosing the desired probe type, the system will automatically

configure to the preset attenuation factor.
 The attenuation factor changes the vertical scaling of the Scopebox so that the measurement results reflect the actual voltage levels at the probe tip.
 The user also can set the factor from the options manually or tapping the   to change it.

4.2.3 Trigger Setting

Trigger indicates that when certain waveform meets the conditions that are predefined according to the requirements, the Scopebox acquires the waveform and its adjacent section, and then presents it on the screen.

Go to **Menu** -> **Trigger**, the following screen will appear:

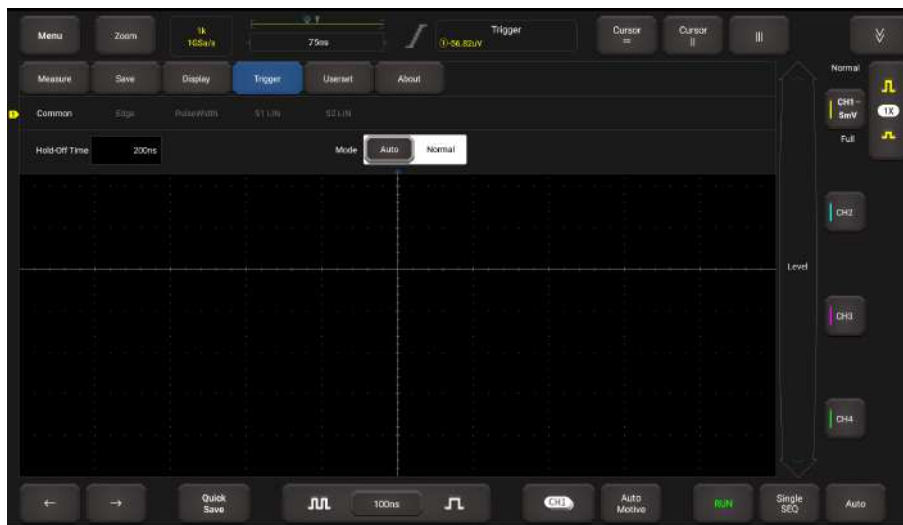

Common allows you to set the sweep mode. The sweep mode determines how the Scopebox behaves in the absence of a trigger event. The Scopebox provides two trigger modes: Auto, Normal.



Auto: It allows the Scopebox to acquire waveforms even when it does not detect a trigger condition. If no trigger condition occurs while the Scopebox is waiting for a specific period, it will force itself to trigger. When forcing invalid triggers, the Scopebox can not synchronize the waveform, and then waveform seems to roll across the display. If valid triggers occur, the display becomes stable on the screen.

Normal: This mode allows the Scopebox to acquire a waveform only when it is triggered. If no trigger occurs, the Scopebox keeps waiting, and the previous waveform, if any, will remain on the display.

If **Edge** trigger is selected (An edge trigger determines whether the Scopebox finds the trigger point on the rising/falling/dual edge of a signal.):



Menu	Comments/Settings
Source	Select which channel as trigger signal.
Edge	Rise: Trigger on rising edge. Fall: Trigger on falling edge. Dual: Trigger on dual edges.
Couple	Trigger coupling determines what part of the signal passes to the trigger circuit.
Noise Rejection	Reject high frequency noise when selected.

In this mode, the user can set the trigger level by directly dragging the Level scroll bar on the right side of the waveform display area.



If **Pulse Width** trigger is selected (Pulse trigger occurs according to the width of pulse. The abnormal signals can be detected through setting up the pulse width condition):



Menu	Comments/Settings
Source	Select which channel as trigger signal.
Condition	To select pulse condition. It mainly includes: +More, +Less, +Equal, -More, -Less, -Equal etc.
Pulse Width	Set required pulse width.
Noise Rejection	Reject high frequency noise when selected.

S1 LIN and **S2 LIN** refer to the measurement settings of LIN and CAN, which are used in the automotive communication BUS.

4.3 Auto-Set

The Scopebox has an Auto-set feature that sets up the Scopebox automatically to display the input signal in a best fit.

Tap **Auto**, the Scopebox may change the current settings to display the signal. It automatically adjusts the vertical and horizontal scaling, as well as the trigger coupling, position, slope, level and mode settings.

4.4 Menu Operations

4.4.1 Measure

The Scopebox provides 23 parametric auto measurements. Tap **Measure**, the following screen will appear:



Tap to select the desired measurement item (Maximum 10 items can be selected at the same time). All selected items will be shown on the left side (see red field shown below) of the **Clear** button.

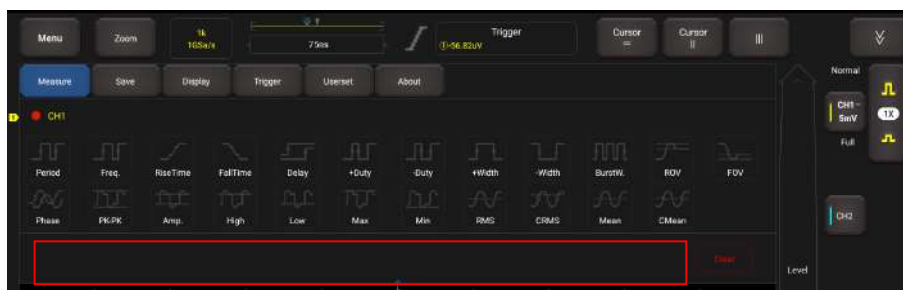

Tap it to remove the measurement item. The values corresponding to the selected items will be displayed on the bottom of the screen.

- Period: Time to take for the first signal cycle to complete in the waveform.
- Frequency: Reciprocal of the period of the first cycle in the waveform.
- Rise Time: Time taken from lower threshold to upper threshold.
- Fall Time: Time taken from upper threshold to lower threshold.

- +Duty: Positive Duty Cycle = (Positive Pulse Width)/Period x 100%, Measured of the first cycle in waveform.
- -Duty: Negative Duty Cycle = (Negative Pulse Width)/Period x 100%, Measured of the first cycle in waveform.
- +Width: Measured of the first positive pulse in the waveform. The time between the 50% amplitude points.
- -Width: Measured of the first negative pulse in the waveform. The time between the 50% amplitude points.
- PK-PK: Peak-to-peak = Max-Min, Measured over the entire waveform.
- Amp.: Amplitude = Base-Top, Measured over the entire waveform.
- High: Voltage of the statistical maximum level, Measured over the entire waveform.
- Low: Voltage of the statistical minimum level, Measured over the entire waveform.
- Max: Voltage of the absolute maximum level, Measured over the entire waveform.
- Min: Voltage of the absolute minimum level, Measured over the entire waveform.
- RMS: The Root Mean Square voltage over the entire waveform.
- Mean: The arithmetic mean over the entire waveform.
- CMean: Cycle Mean. The arithmetic mean over the first cycle in the waveform.

The following illustrations explain some common measurement items for your reference.

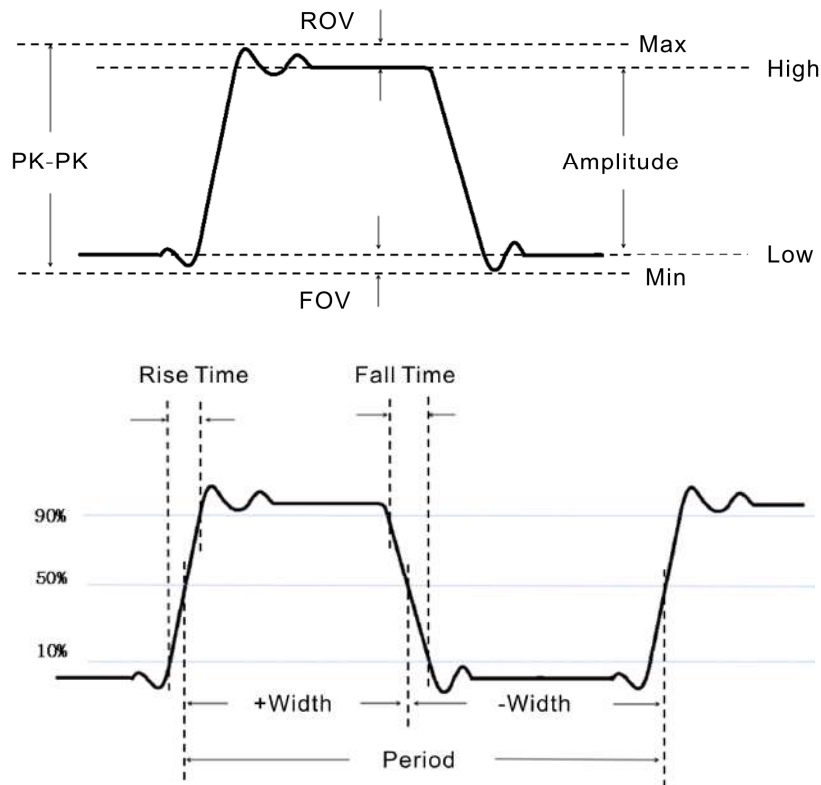

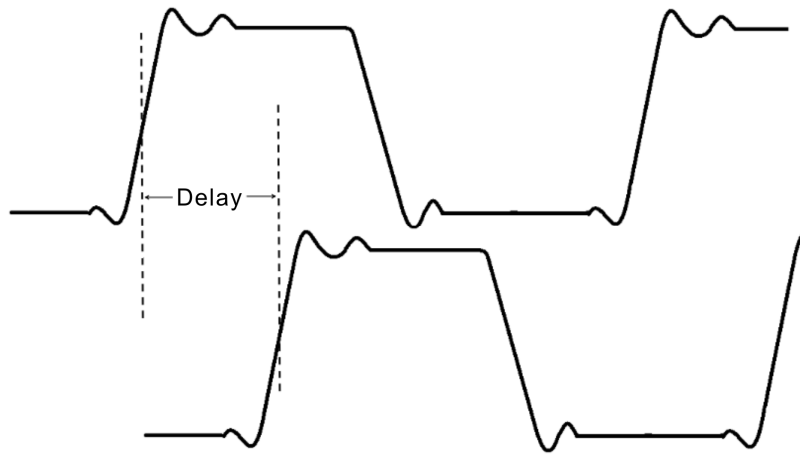

Tap **Clear** to clear all measurement items on the screen.

 Note: The results of the automatic measurements will be displayed on the bottom of the screen. Maximum 10 results could be displayed at the same time.

4.4.2 Save

This function allows you to save the waveforms of the channels.

Tap **Save**, the following screen will appear:



Select the desired measurement channel and save type (.WAV or .CSV), tap the default file name to revise it. Tap **Save** to save it. Alternatively, the user can save the waveform files to the designated folder (R1, R2, R3 and R4). **If the files are saved under the folder, the user can recall the saved files (go to [Userset](#) -> [Save Recovery](#)) for reference and play back.**

4.4.3 Display

This function enables you to set the display form in which the waveforms are displayed. Tap **Display**, the following screen will appear:



There are two options available: Common and Graticule.

Common allows you to set the horizontal reference, brightness of the waveform.

Graticule includes the display mode settings (including Full, Grid, Retical and Frame) and waveform color intensity.

4.4.4 Trigger

This function is used to set the trigger condition and settings. For details, refer to Chapter 4.2.3.

4.4.5 Userset

This function enables you to make some system settings. Tap **Userset**, the following screen will appear:



It mainly includes the following options:

Depth: Storage depth.

Factory Reset: The Scopebox app is set up for normal operation when it is shipped from the factory. This is the factory setup. This option allows you to recall this setup.

Self Adjust: The self-calibration routine lets you optimize the oscilloscope signal path for maximum measurement accuracy. Refer to Chapter 3.3 for detailed operations.

Save & Recovery: Save allows user to save some settings that have been made as a system configuration file. Recovery allows user to directly recall the configuration file to avoid repeated setups.

4.4.6 About

Displays the basic information of the app.

4.5 Zoom

If the displayed waveform contains some valuable information of the collected data, the user can stop acquiring data and zoom in to analyze. Meanwhile, the Zoom mode also allows user to observe the whole waveform and partial details in case of larger storage depth.

Zoom mode provides one main window and one Zoom window. The selected segment of the main window will be zoomed in and displayed in the Zoom window.



Note: This function only applies to the acquired data or the data that has been stopped.

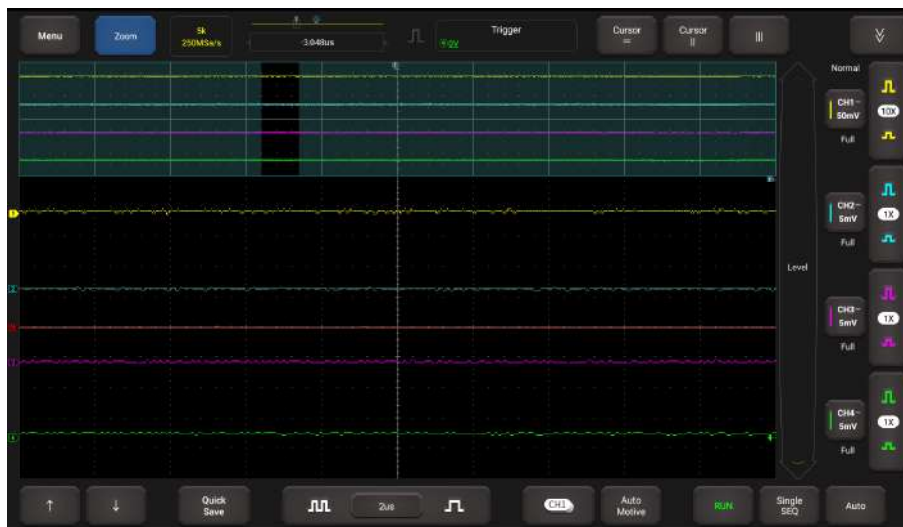

4.6 Cursor Operations

The Cursor function can be used for assisting in measurement.

Tap to turn on the cursor function and place the cursor on the measurement point to read the waveform measurement value.

There are two types of cursors: horizontal cursor and vertical cursor. The horizontal cursor measures the value in the vertical direction, and the vertical cursor can measure the value in the horizontal direction.

When set to ON, two horizontal/vertical reference lines named with Y1 & Y2/X1 & X2 will be displayed on the waveform display area. The user can use or to fine tune the line or drag the line directly to move it.

Tap again to turn it off.



Notes:

Δ Reading: indicates the difference between the two cursor positions.

The voltage reading after Y1, Y2: indicates the position of the activated cursor in the horizontal cursor relative to the zero level.

The time reading after X1, X2: indicates the position of the activated cursor in the vertical cursor relative to the trigger point.

1/ ΔX : Frequency

4.7 Quick Save

This function is used to quickly save the currently running measurement waveform. The Scopebox can save the analog channel or math channel waveform to the local folder, and the file type can be WAV or CSV.

The Scopebox provides 4 reference (REF) channels (R1, R2, R3 and R4). The user can load WAV files into the REF channel, and open the REF channel to display the reference waveform.

4.8 Automotive Operations

This function provides all kinds of the testing applications on the automotive parts (including circuits, sensors, actuators, ignition etc.) and detailed connection methods.

Tap **Automotive**, the following screen will appear:

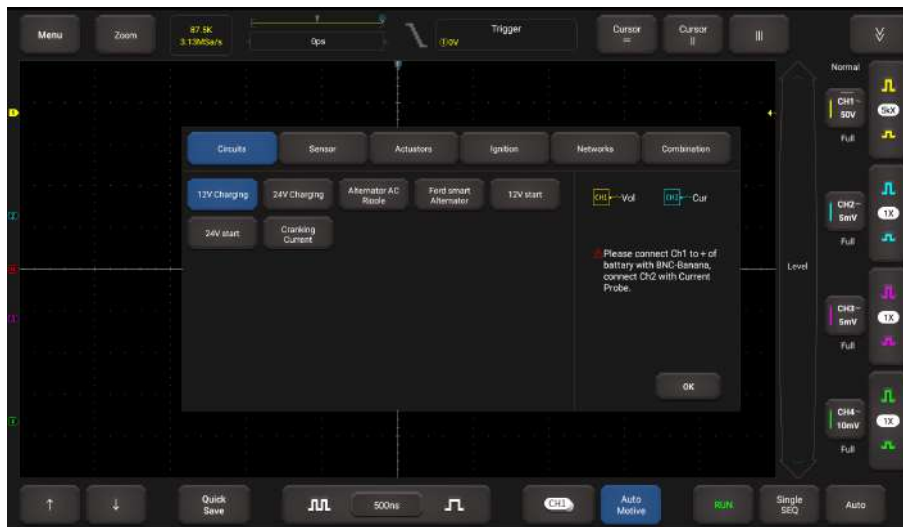

Tap to select the desired automotive part, the system will automatically configure the option to the preset parameters. The user does not need to make any settings. Just follow the on-screen instructions to make connections and proceed.

4.9 MATH & REF

MATH and REF are rarely used and folded, which can be called out by tapping

Tap , the following screen will appear:



4.9.1 MATH

In this function, the user can use the addition, subtraction, multiplication and FFT function to operate and analyze the waveform.

Tap **MATH**, the MATH channel will work as the current channel and the marker will appear on the screen.



Four Types:

A + B Add source 1 and source 2

A - B Subtract source 2 from source 1

A × B Multiply source 1 by source 2

A ÷ B Divide source 2 with source 1

FFT Convert a time-domain signal into its frequency components (spectrum).

Select operate type, Source 1 and 2, then adjust the vertical scale to view the math channel clearly. The mathematic result can be measured by the measure and the cursor.

Tips on MATH calculations

- If the analog channel or math function is clipped (not completely displayed on the screen), the resulting math function will also be clipped.
- After the math waveform is displayed, tap the channel marker to close the source channel to better view the math waveform.
- You can adjust the vertical sensitivity and offset of each channel participating in the math function to facilitate viewing and measuring math waveforms.
- Use the **Cursor** and **Measure** to measure math function waveforms.

4.9.2 REF

This function enables you to load the reference waveform from the R1/R2/R3/R4 from your tablet.

Tap **REF**, the following screen will appear:



Slide the switch of R1/R2/R3/R4, the system will recall the waveform that was previously saved in this folder. Tap the waveform in line with the Recall, a small window displaying this waveform will pop up on the screen.

4.10 Phase Ruler

It can be used to help measure the timing time of the cyclic waveform.

Tap , a dialog box will pop up on the screen. Set the number of cylinder and angle, tap **OK** to confirm.



You can drag the two phase rulers to the appropriate position to mark the start and end of the loop. The bottom of the ruler shows the default phase start point 0° and end point 360° , which can be edited to any value. For example, when measuring the timing of a four-stroke cylinder, the end of the phase is usually displayed as 720° , because one cycle includes two crankshaft rotations.

5 Ignition



The ignition system is the system which has greatest impact on the performances of gasoline engine, as the statistical data shows that nearly half of the failures are caused by poor work of electrical system. And the performance tests of engine often start from the ignition system. Nowadays ignition system includes distributor and distributorless. Distributorless includes independent ignition and simultaneous ignition.

1. Distributor ignition system i.e. contact breaker with contact-controlled ignition system (commonly known as the platinum) and contact breaker with noncontact-controlled ignition system combined with magnet, hall components or infrared.
2. Independent ignition system: crankshaft sensor send out the ignition timing signal and cylinder identification signal so that the ignition system can send out ignition signal to specified cylinder in specified time, each cylinder has its independent ignition coil.
3. Simultaneous ignition system: two cylinders share one ignition coil, when two cylinder pistons reach top dead center at the same time (one is compression, another is the exhaust), two spark plugs will be ignited at the same time, at this time, the ignition for the former cylinder is in high-pressure low temperature gas mixture, the ignition is valid, while for the latter one is in low-pressure high temperature exhaust gas, the ignition is invalid.

This app can test and analyze the secondary signal for various engine ignition systems.

5.1 Secondary-distributor ignition analysis

The following connection should be made before performing it:

1. Power the Scopebox on: Power is provided to the Scopebox in either of the following ways:
 - **Battery clamps cable:** Plug one end of the power adaptor into the DC-IN port of the Scopebox, and then clamp the other two terminals to the vehicle's battery (Red to +, and Black to -) respectively.
 Note: This connection only applies to the condition that the diagnostic tool cannot provide enough power to the Scopebox via USB cable.
 - **USB cable (optional):** Insert one end of the power adaptor into the Power interface of the Scopebox, and the other end to the AC outlet.
 Note: This connection only applies to the condition that the diagnostic tool can supply enough power to the Scopebox directly via USB cable.
2. Connect the B-shaped terminal of the USB cable to the USB port of the Scopebox, and the other end to the USB port of the diagnostic tool.
3. Plug the BNC end of secondary ignition pickup into CH1/CH2/CH3/CH4 channel of the Scopebox, and connect the high-voltage clip to high-voltage line, and crocodile clips to ground.

 Note: Common ignition sequence (the specific sequence is subject to the actual engine ignition sequence)

Four-stroke in-line four-cylinder: 1-2-4-3, or 1-3-4-2

Four-stroke in-line six-cylinder: 1-5-3-6-2-4, or 1-4-2-6-3-5

Four-stroke in-line eight-cylinder: 1-8-4-3-6-5-7-2

Five-cylinder: 1-2-4-5-3

V 6 engine: generally speaking, based on the person sitting on the driver cab, if the right side cylinder numbers on the right side, from the front to the back are as follows: 1, 3, 5; and the cylinder numbers on the left side, from the front to the back are as follows: 2, 4, 6; then the ignition sequence is: 1-4-5-2-3-6. If the cylinder numbers on the right side, from the front to the back are as follows: 2, 4, 6; and cylinder numbers on the left side, from the front to the back are as follows: 1, 3, 5; then the ignition sequence is: 1-6-5-4-3-2.

Figure 5-1 below shows the normal ignition waveform of distributor ignition system, the upper one is the

secondary waveform, and the lower one is the primary waveform.

The secondary waveform

A section is contact open period; B section is make contact period, which is the magnetizing field of ignition coil.

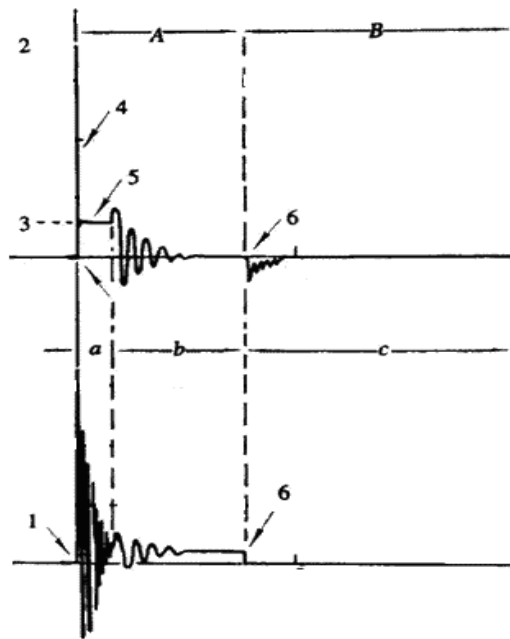

Fig. 5-1

- 1) Contact break point: the primary circuit of ignition coil cut off, the secondary voltage was sensed and increased sharply.
- 2) Ignition voltage: secondary coil voltage overcome the damper of high voltage line, the contact breaker gap and the spark plug gap to release magnetizing energy, 1-2 section is the breakdown voltage
- 3) Spark voltage: For the capacitor discharge voltage
- 4) Ignition voltage pulse: For the charge and discharge sections
- 5) Spark line: The inductance discharge process, i.e. the mutual inductance voltage of ignition coil maintains the conduction of secondary circuit
- 6) Contact point close the current flow into primary coil, the primary coil oscillates due to the mutual inductance.

Primary ignition waveform

Section **a** shows the voltage oscillation on the primary circuit due to the magnetic induction of spark in the duration;

Section **b** shows the damped oscillation generated by remaining magnetic field energy after the spark;

Section **c** shows the make contact magnetizing period of primary coil.

Seen from the waveform, the amplitudes of breaker contact closed angle, break angle and breakdown voltage and spark voltage are very clear, besides, the spark delay period and two oscillations can also be tested. For the ignition system without faults, compared with the whole cycle, the contact closed angle just 45%-50% (four-cylinder), 63%-70% (six-cylinder), or 64%-71% (eight-cylinder); the breakdown voltage is over 15kv; the spark voltage is about 9kv, the spark period is greater than 0.8ms. If these values or waveform are abnormal, it means there is fault or the system needs to be adjusted.

5.2 Secondary-simultaneous ignition analysis

The following connection should be made before performing it:

1. Power the Scopebox on: Power is provided to the Scopebox in either of the following ways:

- **Battery clamps cable:** Plug one end of the power adaptor into the DC-IN port of the Scopebox, and then clamp the other two terminals to the vehicle's battery (Red to +, and Black to -) respectively.

 Note: This connection only applies to the condition that the diagnostic tool cannot provide enough power to the Scopebox via USB cable.

- **USB cable (optional):** Insert one end of the power adaptor into the Power interface of the Scopebox, and the other end to the AC outlet.

 Note: This connection only applies to the condition that the diagnostic tool can supply enough power to the Scopebox directly via USB cable.

2. Connect the B-shaped terminal of the USB cable to the USB port of the Scopebox, and the other end to the USB port of the diagnostic tool.
3. Connect the BNC connector of the secondary ignition pick-up to any channel of the Scopebox, and clamp the crocodile clips and high-voltage clips onto the vehicle ground and high-voltage line respectively.

The connection is as follows:

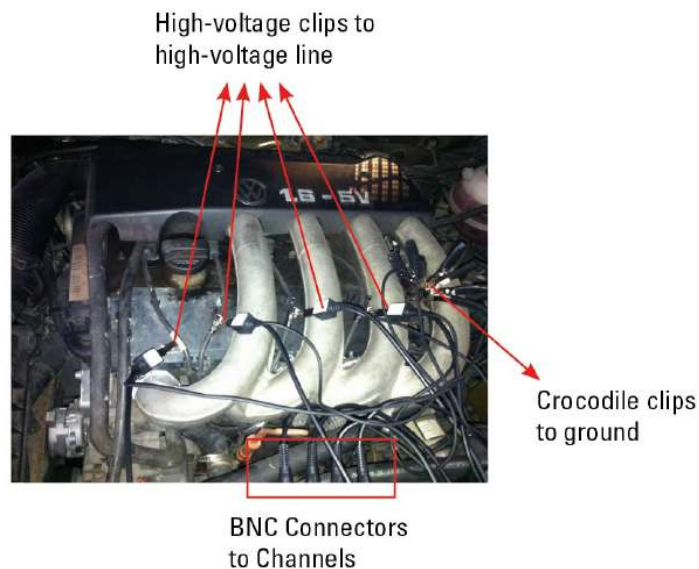

Fig. 5-2 below shows the valid and invalid ignition waveforms. Under the working status of valid ignition, the breakdown voltage and spark voltage are higher because the cylinder is filled with fresh combustible mixture gas, which has a lower ionization level and vice versa.

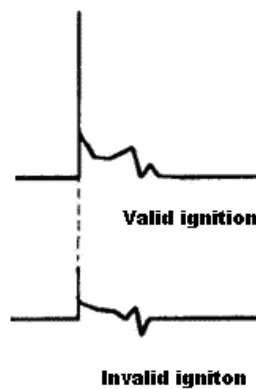



Fig. 5-2

5.3 Secondary-direct ignition analysis

Connection:

1. Power the Scopebox on: Power is provided to the Scopebox in either of the following ways:
 - **Battery clamps cable:** Plug one end of the power adaptor into the DC-IN port of the Scopebox, and then clamp the other two terminals to the vehicle's battery (Red to +, and Black to -) respectively.

 Note: This connection only applies to the condition that the diagnostic tool cannot provide enough power to the Scopebox via USB cable.
 - **USB cable (optional):** Insert one end of the power adaptor into the Power interface of the Scopebox, and the other end to the AC outlet.

 Note: This connection only applies to the condition that the diagnostic tool can supply enough power to the Scopebox directly via USB cable.
2. Connect the B-shaped terminal of the USB cable to the USB port of the Scopebox, and the other end to the USB port of the diagnostic tool.
3. *When the high-voltage wire is exposed*, plug the BNC end of secondary ignition pickup into CH1/CH2/CH3/CH4 channel of Scopebox, then connect the high-voltage clip to high-voltage line, and crocodile clips to ground.
4. *If no high-voltage wire is exposed*, dismantle ignition coil of tested cylinder. Connect one end of the COP extension cord to the ignition coil which should be grounded via COP earth cord, and insert the other end into the cylinder to joint with spark plug. Then plug the BNC end of secondary ignition pickup into CH1/CH2/CH3/CH4 channel of Scopebox, and then connect the high-voltage clip to high-voltage line, and crocodile clips to ground.

The connection is as follows:

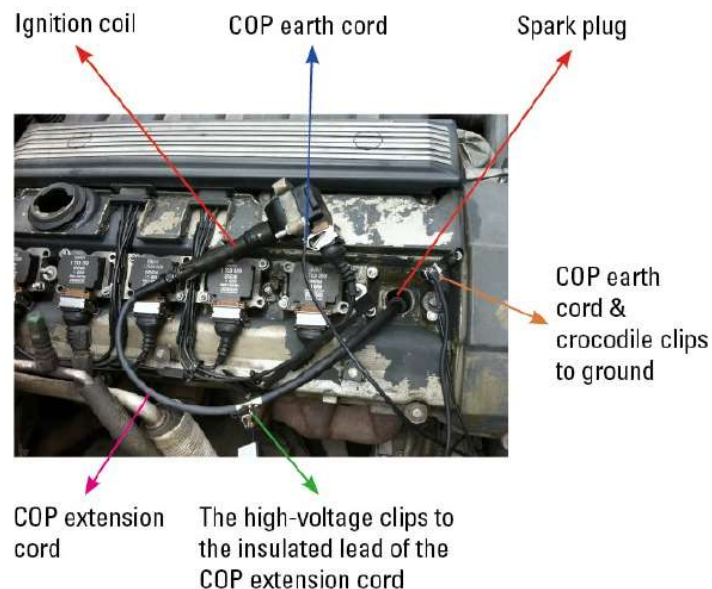

Fig. 5-3 shows the normal secondary (the upper one) and (the lower one) primary ignition waveform of direct ignition system. Because the on/off of primary circuit is not opening/closing of mechanical contact, but the conduction of transistor. The primary voltage has no obvious oscillations within the duration, but the voltage increases during the magnetization process due to current limiting, and this change can cause corresponding fluctuations of secondary voltage line as a result of induction of ignition coil.

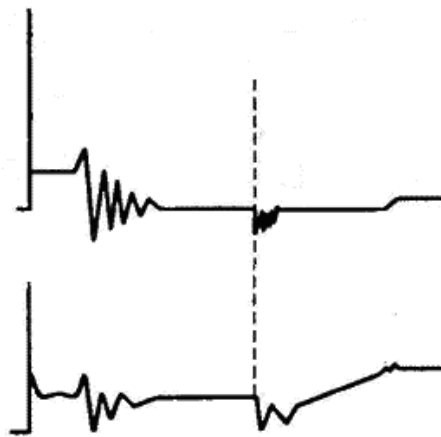

Fig. 5-3

5.4 Waveform analysis mode

The ignition secondary single-cylinder waveform test is mainly used to:

- Analyze the ignition dwell angle of single cylinder.(ignition coil charging time)
- Analyze the capability of ignition coil and secondary high tension circuit (from ignition line to ignition voltage line).
- Find the improper mixture A/F ratio of single cylinder (from combustion line).
- Analyze the capability of capacitance (platinum or ignition system).
- Find the spark plug that causes misfire of the cylinder (from combustion line).

This test can provide very meaningful information about the combustion quality for each cylinder. If necessary, this test can also be performed during driving. Since the secondary ignition waveform is significantly affected by different engines, fuel systems and ignition conditions, it is useful for detecting the faults of engine mechanical parts, fuel system components, and ignition system components. Different parts of the waveform can specify that some components and systems on the specific cylinder have faults. Refer to the instructions for various parts of waveform for the related component working status of specific waveform section.

Test methods and conditions:

Start the engine or drive the vehicle according to the driving performance fault or poor ignition, etc. Confirm the consistence of judgment standard (the amplitude, frequency, shape and pulse width, etc., for each cylinder), check the fault of the waveform for corresponding components.

Waveform results: observe the ignition coil at the beginning of charging, the relative consistent falling edge represents the dwell angle and ignition timing of each cylinder are precise.

Ignition line:

Observe the height consistence of flashover voltage. Too high flashover voltage (even out of the oscilloscope screen) represents a high resistance existed in the ignition secondary circuit (for example, open circuit, or damaged spark plug or high voltage line, or too large time gap on spark plug), while the too short sparking voltage represents the resistance of ignition secondary circuit is lower than normal value (due to pollutant and broken spark plug or the high voltage line of spark plug has electrical leakage, etc.).

Spark or combustion voltage:

Observe the consistence of spark or combustion voltage, as it represents the consistence of spark plug and the air-fuel ratio of each cylinder. In case that the mixing ratio is too lean, the combustion voltage will be lower than normal value.

Combustion line:

Observe the spark or the combustion line which shall be clean with few clutter, as lots of clutter indicates the cylinder has poor ignition due to ignite too early, damaged nozzle, pollutant spark plug, or other reasons. The duration of combustion line indicates the mixing ratio of the cylinder is abnormal lean or rich. Too long combustion line (usually greater than 2ms) represents the mixing ratio is rich, whereas too short of combustion line (usually less than 0.75ms) represents the mixing ratio is lean.

Ignition coil oscillation:

Observe at least two oscillation waveforms after the combustion line, which will be better if more than three oscillation waveforms, as it represents the ignition coil and capacitor (on Platinum or ignition system) are normal.

Primary voltage analysis

According to the faulty primary voltage waveform collected by the ignition analysis, the related components and mechanical equipment status of ignition system electrical circuit can be analyzed, which provides a reliable basis for the adjustment and maintenance of power circuit to avoid the blind demolition.

The waveform shown on Fig. 5-4, appears a lot of clutter on the contact break point, which is obviously caused by the serious erosion on contact break point. It can be verified via burnishing the contact or changing the circuit breaker.

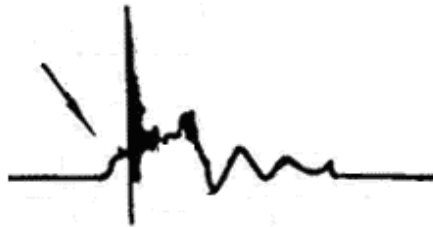

Fig. 5-4

For the primary voltage waveform shown on Fig. 5-5, the damped attenuation cycles obviously reduced on the spark period, the amplitude became lower, which is evidently caused by capacitor leakage.

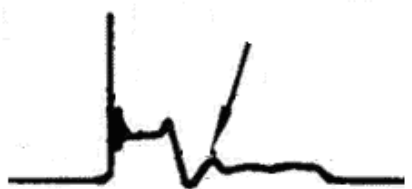

Fig. 5-5

The waveform on Fig. 5-6 shows the accidental pumping during contact closing period. The irregular beating is caused by insufficient spring force.



Fig. 5-6

The curve on Fig. 5-7 shows the contact angle is too small during the magnetizing period, which is caused by too large contact gap.



Fig. 5-7

A lot of clutter will be displayed on the horizontal section of primary waveform if contact has poor grounding, as shown below Fig. 5-8.

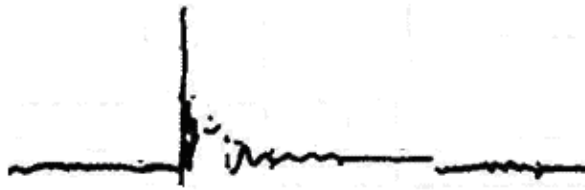

Fig. 5-8

Fig. 5-9 shows the fault of low-voltage waveform in electronic ignition system. The voltage does not rise during magnetizing, which indicates that the effect of limitation of the circuit failed and no components on distributorless ignition system can be adjusted. When this waveform is abnormal, you can only replace the ignition coils, igniter, ignition signal generator and cam position sensor, etc., one by one, to find out the faulty component or module.



Fig. 5-9

The secondary waveform is also affected by the spark plug, the combustion process, mixture gas composition, the engine thermal state of the ignition coil, etc., which is more complicated. The following lists a large number of measured secondary faulty waveform for reference. Since various factors lead to the failures, Fig. 5-10 just shows the major possible factors for the failures.

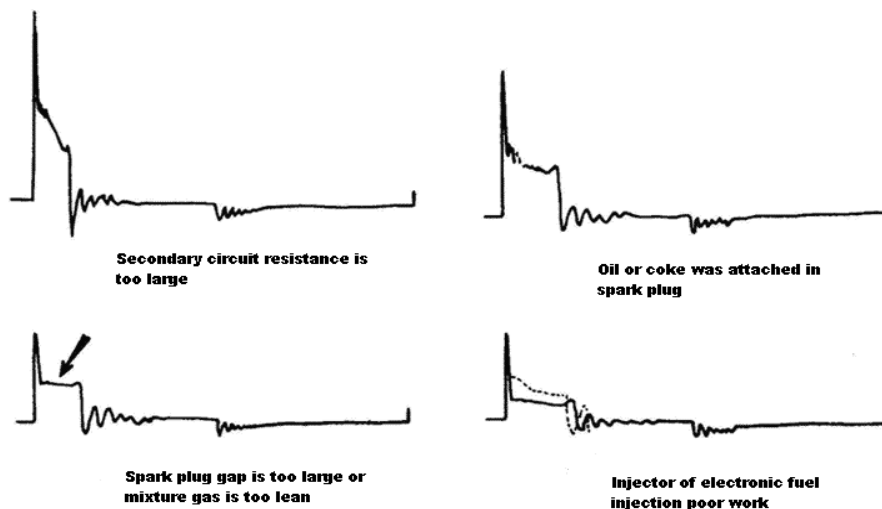

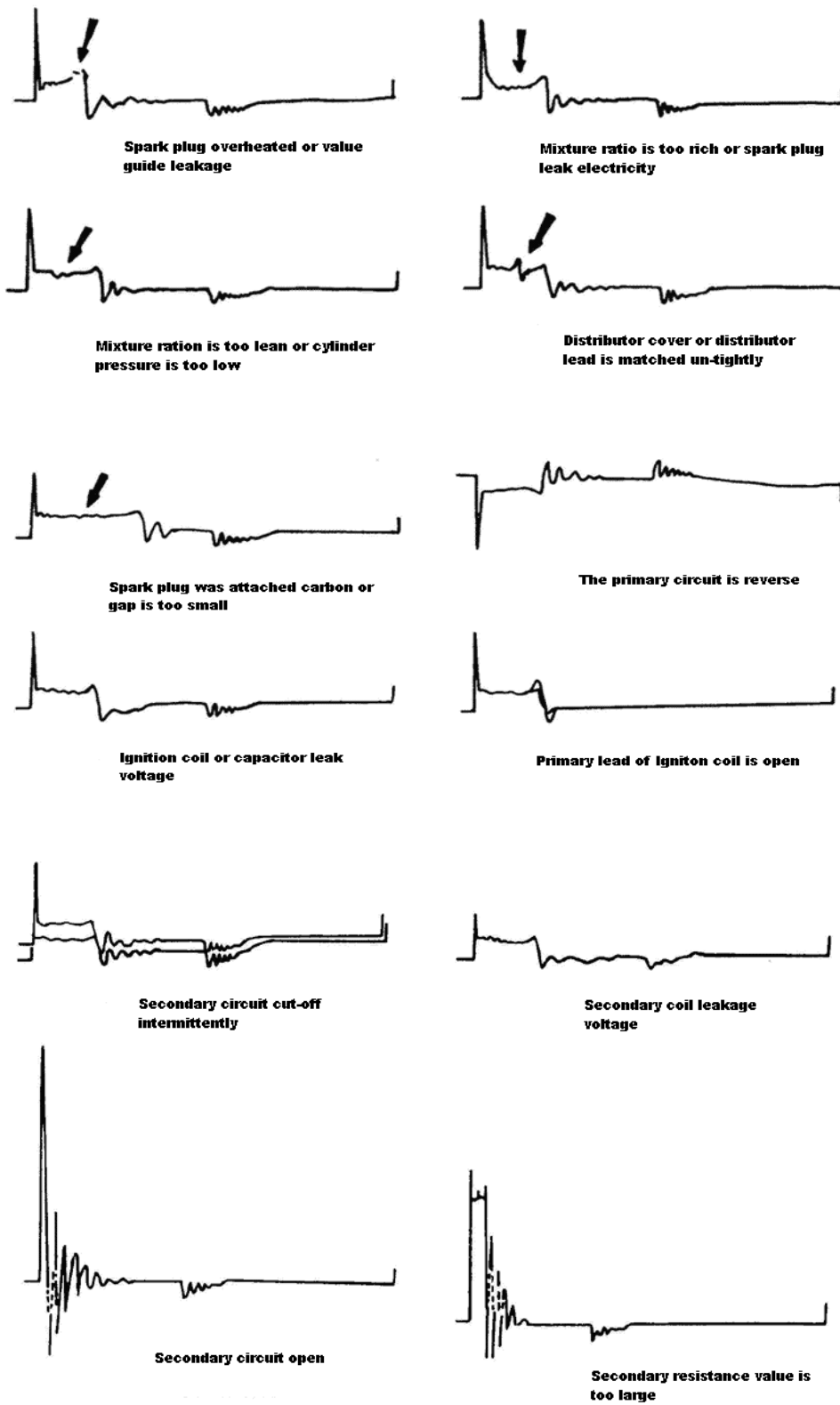

Fig. 5-10

6 Care & Maintenance

General Care

Do not store or leave the oscilloscope where the device will be exposed to direct sunlight for long periods of time.

Caution

To avoid damages to the device or probes, do not expose them to sprays, liquids or solvents.

Cleaning

Inspect the device and probes as often as operating conditions require. Make sure the device disconnect from all power sources.

To clean the exterior surface, perform the following steps:

1. Remove loose dust on the outside of the oscilloscope and probes with a lint-free cloth. Use care to avoid scratching the clear glass display filter.
2. Use a soft cloth dampened with water to clean the device.

Caution

To avoid damages to the surface of the device or probes not use any abrasive or chemical cleaning agents.