

X-881 PRO

Professional Mobile Wheel Aligner

User Manual

**LAUNCH
TECH USA**
CREATE • CHANGE

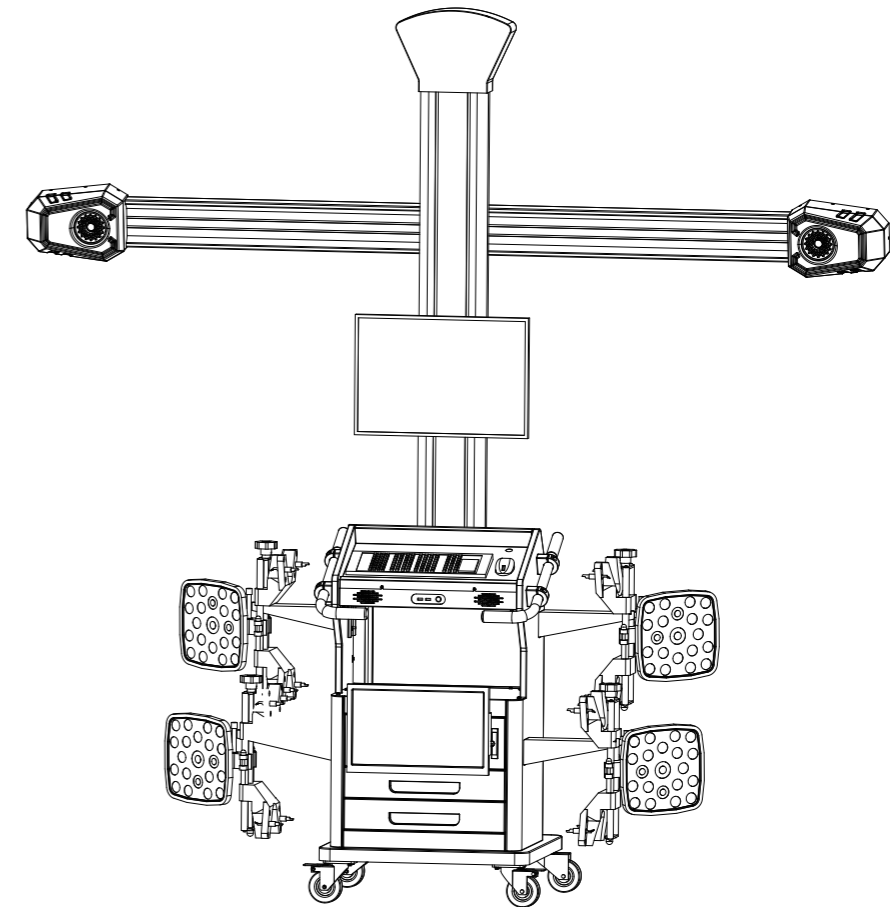

LAUNCH TECH USA INC.

Address: 1820 S. Milliken Ave Ontario, CA 91761
<http://www.launchtechusa.com>
Toll Free: 1-877-528-6249
Phone: 562-463-1580

⚠ WARNING

Read this material before using this product.
Failure to do so can result in serious injury.

制作要求：

| | |
|----|----------------------------|
| 尺寸 | 210x297mm（210x285mm亦可） |
| 印刷 | 黑白印刷 |
| 材质 | 封面采用157g双铜纸+过哑胶，内页采用80g书写纸 |
| 装订 | 骑马钉 |

All rights reserved! Any company or individual person shall not copy or backup this user manual in any format (electronic, mechanical, photocopying, recording or other formats) without written permission from Launch Tech USA Inc (hereinafter referred to as "Launch Tech USA"). The manual is for the use of the products manufactured by Launch Tech USA, which shall not assume any responsibility for the consequences arising from the use of it to guide the operations of other equipment.

Launch Tech USA and its branches will not bear any liability for the fees and expenses incurred by equipment damage or loss due to accidents caused by users or third parties, misuses and abuses, unauthorized modifications and repairs, or operations and services not following Launch Tech USA's instructions.

Launch Tech USA assumes no responsibility for device damages or problems resulted from the usage of other parts or consumables, rather than original products of Launch Tech USA or products approved by the company.

Official statement: the mentioning of the names of other products in this manual is to illustrate how to use the device, with the ownership of the registered trademarks belonging to the owners.

The device is intended for the use of professional technicians or maintenance and repair personnel.

Registered Trademark

Launch Tech USA has registered its trademark in china and several other countries, and the logo is



. Other trademarks, service marks, dot names, icons, company names of Launch Tech USA mentioned in the user manual all belong to Launch Tech USA and its subsidiaries. In those countries where trademarks, service marks, dot names, icons, company names of Launch Tech USA have not been registered yet, Launch Tech USA disclaims the right for its unregistered trademarks, service marks, dot names, icons, and company names. Trademarks of other products and company names mentioned in this manual are still owned by the original registered companies. Without written agreement from the owner, no person is allowed to use the trademarks, service marks, domain names, icons and company names of Launch Tech USA or of other mentioned companies. You can visit <http://www.launchtechusa.com>, or write to Customer Service Center of Launch Tech USA at 1820 S. Milliken Ave Ontario, CA 91761, to get contact with Launch Tech USA for the written agreement on the usage of the user manual.

Precautions

- Please read the User's Manual carefully, and check the packing list before the installation and commissioning. For any questions, please do not hesitate to contact us or our distributors.
- Only the qualified technician who has been trained in the relevant installation skills by Launch Tech USA can install the wheel aligner.
- Only the qualified technician who has been trained in the relevant product technology can operate the wheel aligner.
- The operator must have knowledge of computer application and basic theory of wheel alignment.
- The operator must have the common sense of safety in the use of lifter and vehicle maintenance.
- The power voltage of X-881 PRO professional mobile wheel aligner is 1PH AC220V±10% 50Hz AC110V±10% 60Hz.
- Check the power cable regularly for its reliability to ensure good contact and no breakage. If the power voltage is not stable, please purchase and use AC voltage stabilizer.

- After the vehicle maintenance, check all loosen screws and parts are properly tightened as required.
- X-881 PRO professional mobile wheel aligner is operated with image sensing; by analyzing the target images recorded by high-resolution video camera. Therefore, during the operation, avoid shading the light path between the target and the camera for long time.
- Do not place the X-881 PRO professional mobile wheel aligner on a slanted or vibrating surface. Avoid moisture and direct sunlight.
- X-881 PRO wheel aligner's targets are the major components. Be careful in storage and operation. Clean the dirt with neutral detergent or ethanol.
- Wires inside the wheel aligner's column and camera beam are tightly connected. Do not touch the wires at random after the installation completed.
- Accurate calibration is made during manufacturing. Do NOT open or adjust the cameras during or after the operation.
- Do NOT disassemble the column, the beam or the target, or else the warranty is expired automatically, and end user will bear the cost of damage.
- When install the wheel clamp, choose a correct installation method according to the actual situation of the wheel rim; tighten with even force, afterwards, lightly pull the wheel clamp to confirm it is securely fixed.
- X-881 PRO professional mobile wheel aligner's cameras are the major optical components for detection. Do keep the filters clean. Gently wipe off the dirt with lens paper.
- Apply even force when using the knobs. Do not tighten too hard to avoid damage to the locking mechanism.
- Turn off the power after operation.

Safety Instructions



The wheel aligner system may not be operated in flammable and explosion-prone surroundings.



The operator must provide appropriate fire protection measures at the measuring platform. In particular, any flammable or self-combusting items (such as cloths soaked in solvents or oil) and fluids, or other ignition sources, should not be stored in the tool trolley.

Operators are expected to be considerate during the operation to avoid negligent acts:

The operator must specifically verify that:

- The machine is only used according to the specifications.
- The necessary personal safety equipment for operation and maintenance personnel is available and not aged or worn.
- The operating instructions are always in a legible condition and are completely available at the machine location.
- The machine is only operated, maintained and repaired by qualified and authorized personnel.
- This personnel is instructed routinely in all pertaining questions of work safety and environmental protection, and knows the operating instructions, especially the safety instructions contained therein.

- All safety and warning labels attached to the machine are not removed and are legible.

Basic safety measures during normal operations:

The machine may only be operated by trained and authorized personnel who know the operating instructions and capable of working with the equipment!

Prior to switching the machine on, check and verify that:

Only authorized personnel are located within the working range of the machine.

No one can be injured when the machine is activated!

Check the machine for visible damages prior to use and verify that it is only operated in perfect condition!

Report any problems immediately to the supervisor!

Prior to each operating start, check and verify that all safety equipment operates perfectly!

Basic safety measures during service and maintenance:

Adhere to the inspection and maintenance intervals specified in the operating instructions!



Block access to the working area of the machine to unauthorized personnel prior to performing maintenance or repairs! Attach or set up a warning sign that points out maintenance or repair work!

Contents

| | |
|---|-----------|
| Chapter 1 Introduction | 1 |
| 1.1 Definition | 1 |
| 1.2 When wheel alignment will be needed | 1 |
| 1.3 Major alignment parameters | 1 |
| 1.4 Function and Feature | 4 |
| 1.5 Technical Specifications | 5 |
| 1.6 Requirement on Surroundings | 5 |
| 1.7 Working Principle | 6 |
| Chapter 2 Hardware Structure | 7 |
| 2.1 Overall Structure | 7 |
| 2.2 Target and Clamps | 7 |
| 2.3 Communication Cable | 7 |
| 2.4 Turntable and Transit Bridge | 7 |
| 2.5 Steering Wheel Holder | 7 |
| 2.6 Brake Pedal Depressor | 7 |
| Chapter 3 Basic Operation Procedure | 8 |
| 3.1 Pre-check | 8 |
| 3.2 Alignment Measurement | 8 |
| 3.3 Adjustment | 8 |
| 3.4 Test Run | 8 |
| Chapter 4 Operation Instruction | 9 |
| 4.1 Preparation before Test | 9 |
| 4.2 Software Operation | 9 |
| Chapter 5 FAQ | 24 |
| 5.1 Computer Operation | 24 |
| 5.2 Standard Measurement | 24 |
| Chapter 6 Maintenance | 25 |
| 6.1 Computer Maintenance | 25 |
| 6.2 Printer Maintenance | 26 |
| 6.3 Target and Clamp Maintenance | 26 |
| 6.4 Column, Lateral Beam and Signal Cable Maintenance | 26 |
| 6.5 Turntable Maintenance | 26 |
| Warranty | 27 |

Chapter 1 Introduction

1.1 Definition

X-881 PRO professional mobile wheel aligner is used to test the wheel parameters and provide reference of manufacturer specifications. By comparing the two set of parameters, operator can adjust the vehicle wheel parameters to reasonable range, to achieve ideal driving performance and avoid unreasonable tire wear.

1.2 When wheel alignment will be needed

Wheel alignment will be necessary when any one of the following occurs:

- Vehicle pull to one side when release steering wheel.
- Uneven tire wear.
- Steering wheel too heavy, too light or shake when driving at high speed.
- After tire change, chassis parts replacement.
- After collision.
- After 3000 km's drive of new car.
- At regular vehicle maintenance.

1.3 Major alignment parameters

Wheel alignment angles are relative angles of the chassis parts, which make the vehicle running stable and reduce tire wear.

Major wheel alignment angles include: Camber, Toe-in, Caster, Steering Axle Inclination, etc.

1.3.1 Camber

Camber is the angle of the wheel relative to vertical, as viewed from the front or the rear of the car. If the wheel leans in towards the chassis, it has negative camber; if it leans away from the car, it has positive camber. See Fig.1.1. This angle determines the contact point and force point between the wheel and the road, directly affecting the tire adhesion and wear status, and changing the load distribution on the axle to avoid abnormal wear to the bearing. In addition, the camber can counteract the angle change generated by mechanical deformation of suspension system and clearance of active surface after load applied to the body. It also affects the heading direction, just like a motorcycle turns by leaning the body. Therefore, the left and right wheel cambers must be equal. Together with the Toe-in, it could enhance the straight-line running stability and avoid uneven tire wear. Without camber, the wheels will tilt to the inside at full load, which increases the possibility of uneven tire wear and wheel bearing wear. Hence, this parameter can extend the life of tire and wheel bearing.

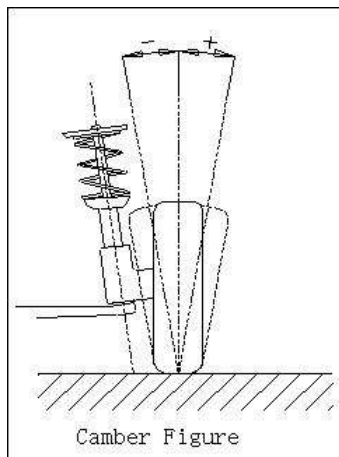

Fig.1.1

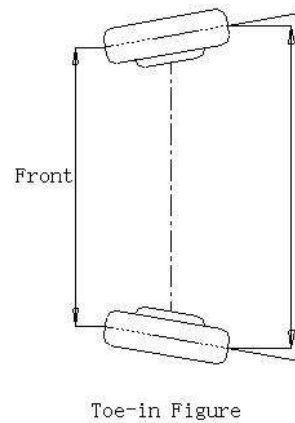

Fig.1.2

1.3.2 Toe-in

When a pair of wheels is set so that their leading edges are pointed slightly towards each other, as viewed from the top, the wheel pair is said to have toe-in. Toe-in figures are given a positive value. Conversely when the wheels point outwards they are toe-out and the figures are shown as a negative value. See Fig.1.2. The total toe-in value is equal to the sum of the toe-in values of the two wheels, that is, the angle between the two tire centerlines. The purpose of toe-in is to ensure the straight-line running stability by compensating the tendency of the tire rolling inward or outward due to the camber and the road resistance.

1.3.3 Steering Axle Inclination

Steering Axle Inclination (SAI) is the angle of the steering axle relative to vertical, as viewed from the front of the car. See Fig.1.3. Correct SAI can equalize the loads applied on the bearings, so that the life of bearings can be prolonged and the controllability of steering is improved. Without the SAI, the controllability of the steering may be affected; further more, the vehicle weight and the ground counterforce may cause significant stress in the axle and finally damage the axle. Correct SAI is also helpful for the vehicle to restore its straight-ahead position after steering. The inclination is determined when the vehicle suspension is designed. It is usually not service adjustable.

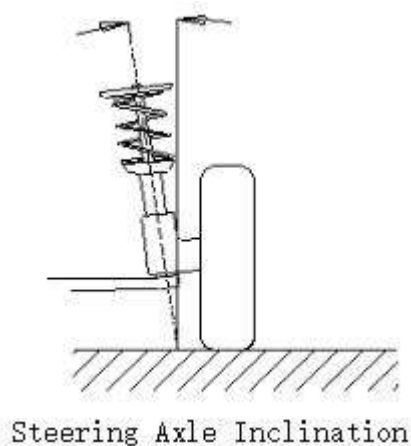

Fig.1.3

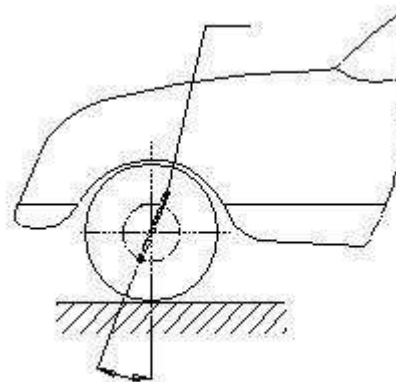

Fig.1.4

1.3.4 Caster

Caster is the angle to which the steering pivot axis is tilted forward or rearward from vertical, as viewed from the side. If the pivot axis is tilted backward, then the caster is positive; if it's tilted forward, then the caster is negative. See Fig.1.4. The caster can make the intersection of the steering axis and the road surface forward of where the wheel contacts the ground, the same effect as seen in the shopping cart, whose front wheels will automatically turn to the direction of the force and keep going straight. The greater the caster angle, the better the straight-line running stability. Greater angle also makes it easier to restore its straight-ahead position after steering, however, the steering may become heavy. Normally caster angle of a vehicle is between 1~4 degrees.

1.3.5 Toe-out on turn

Toe-out on Turn is defined as the difference of the steering angle between the two front wheels when turning left or right by 20°. See Figure 1.5. When the vehicle turns, the inner wheel angle is always bigger than the outer wheel, difference is about 2 degrees. The purpose is to make the vehicle turn smoothly by reference to the instant center point of the extension line of rear axis. The greater the inner wheel angle, the greater the resistance. It makes the vehicle turn easily to the side with larger resistance.

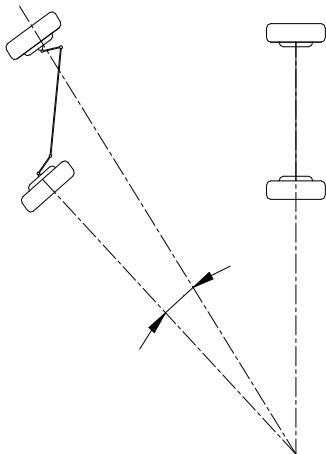

Fig.1.5

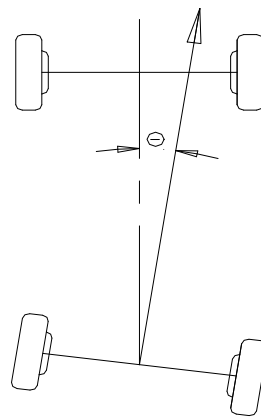

Fig.1.6

1.3.6 Thrust Angle

Thrust Angle is the angle between the vehicle's centerline and the vehicle's thrust line. See Fig.1.6. When the thrust line is at the left side of the vehicle's centerline, the thrust angle is positive, otherwise is negative. The front wheels and the rear wheels should pull to the same side if the thrust angle is not zero. When this happens, adjust the rear toe.

1.3.7 Wheelbase Difference

Wheelbase difference is defined as the angle between the joint line of the centre of two rear wheels and that of the front wheels. It is positive when distance between the centre of the right wheels is larger than that of left wheels; and negative otherwise. If the tread is available from the vehicle specifications, then the wheelbase difference can be also expressed by angle. See Figure 1.7.

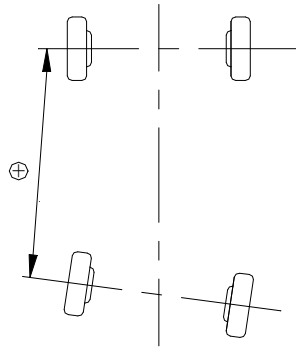

Fig.1.7

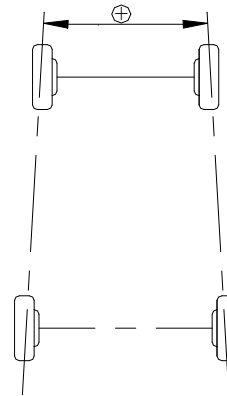

Fig.1.8

1.3.8 Tread Difference

Tread Difference (also called as track width difference) is the angle between the joint line of the ground-contact point of left wheels and that of the right wheels. It is positive when distance between the centre of the rear wheels is larger than that of front wheels; and negative otherwise. If the wheelbases are available from the vehicle specifications, then the tread difference can be also expressed by angle. See Figure 1.8.

1.3.9 Left (right) lateral offset (angle)

It is the relative offset of rear left (right) wheel and front left (right) wheel at the vehicle's lateral direction. When rear left (right) wheel is outside of front left (right) wheel, left (right) lateral offset is positive, otherwise, it's negative. The angle between the thrust line and the joint line of the center of the left (right) front/rear wheels is the left (right) lateral offset angle.

1.3.10 Axle Offset (Angle)

The relative offset of front axle and rear axle at the vehicle's lateral direction is defined as Axle offset. When rear axle is more to the right side than front axle, axle offset is positive, otherwise, it's negative. The angle between the center line of the tread difference angle and the thrust line is defined as axle offset angle.

1.3.11 Delay (Angle)

The same axle's relative offset in longitudinal direction of the vehicle is called the delay. When the right wheel is behind of the left wheel on the same axle, the delay is positive, otherwise, it's negative. The angle between the wheel center line and the vehicle longitudinal geometric center line vertical is called the delay angle.

1.3.12 Included Angle

The sum of kingpin inclination angle and camber angle is called the included angle.

1.4 Function and Feature

- Brand new three dimension computer visual measurement: Adopted high performance camera to

automatically detect the alignment parameter. The camera has been calibrated at production, no need of on-site calibration at installation.

- Passive target: No electric component or wiring on the target, which ensure the equipment to be more convenient and durable.
- X-881 PRO professional mobile wheel aligner can be installed at any height according to user's interest.
- X-881 PRO professional mobile wheel aligner, detect the target height automatically and follow the lift to move up and down freely, to ensure the equipment always in best working height.
- X-881 PRO professional mobile wheel aligner, manually adjust the height to follow the lift, to ensure the equipment always in best working height.
- Extremely simplified test procedure, with human-friendly prompts.
- Complete parameter measurement: Capable of test of front/rear toe-in, front/rear camber, thrust angle, caster, SAI/Kingpin (additional measurement of wheelbase, tread, diagonal angle) etc.
- Large database: More than 20,000 records of vehicle all over the world, and user can add data at will.
- Historical data storage for client management.
- Real-time help system.

1.5 Technical Specifications

Power Supply: AC 1PH AC220V±10% 50Hz AC110V±10% 60Hz

Computer Host: Launch Tech USA customized brand

Monitor: Great Wall 24/32 inch color LCD monitor

Toe-in: Test range 0 ~ ±20°

Camber: Test range 0 ~ ±20°

SAI/Kingpin: Test range 0 ~ ±20°

Caster: Test range 0 ~ ±20°

Thrust Angle: Test range 0 ~ ±5°

Rim diameter: 10" ~ 23"

Caution: *The measure range can only be assured when operate the wheel aligner according to this user manual.*

1.6 Requirement on Surroundings

Ambient temperature: 0 ~ 50°C

Relative humidity: ≤85%

Light condition: No direct Infrared light to the targets

Lift platform height difference: front/end height difference < 2mm

1.7 Working Principle

X-881 PRO professional mobile wheel aligner working principle is as shown in figure 1.9. The entire system can be divided into two categories: data acquisition and data processing.

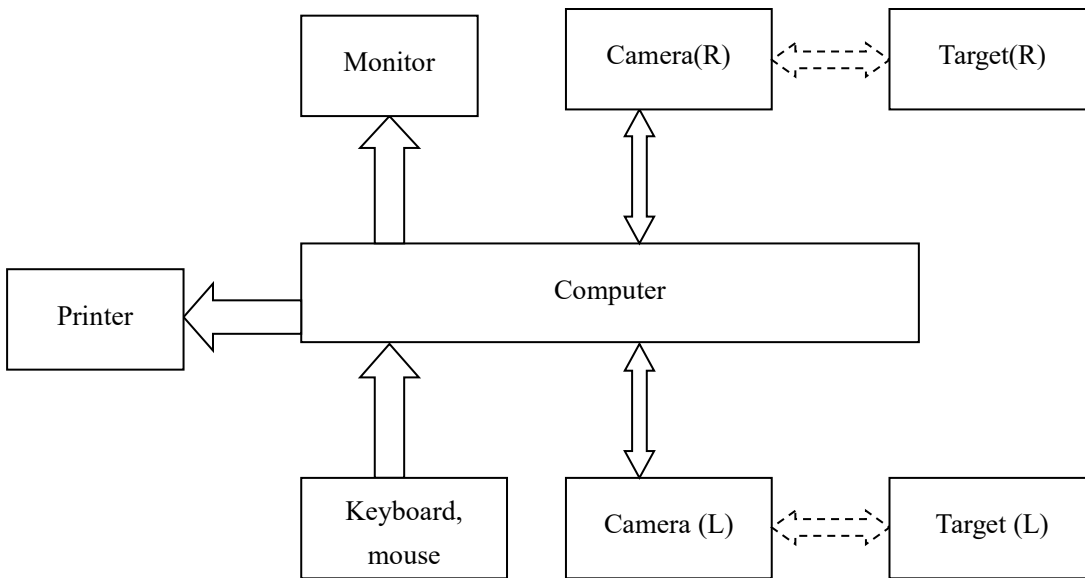

Fig.1.9

Data acquisition category consists of 2 high definition cameras and 4 targets. Left and right side camera get target image and send to data processing category. Target was mounted onto the wheel via clamps, thus to calculate the wheel position by the target point and confirm the wheel alignment parameter.

Data processing category is the core component of X-881 PRO professional mobile wheel aligner, consisting of computer system, power supply system and interface system. The function is to realize operator's instruction, automatically guide the measurement, and calculate the data and display together with OEM data, at the same time, guide the operator to do adjustment on the vehicle. Finally, print out the report.

Since wheel aligner needs to compare the tested data with OEM data, and provide guidance for the adjustment, the database is very important to provide reference data. X-881 PRO professional mobile wheel aligner database covers wheel alignment data of over 20,000 models of vehicle worldwide. At the same time, it provides function for operator to input and save wheel alignment parameter of a new car model.

Chapter 2 Hardware Structure

2.1 Overall Structure

X-881 PRO professional mobile wheel aligner mainly consists of column assembly, lateral beam assembly (includes camera), cabinet, computer host, monitor, printer, targets, clamps, communication cables, turntables (standard), steering wheel holder, brake pedal depressor etc.

Note: The components and accessories of different models of products are different. For details, please consult the dealer or refer to the product packing list.

2.2 Target and Clamps

X-881 PRO professional mobile wheel aligner has 4 targets (come together with 4 clamps). It is a key component for acquiring raw data of wheel alignment. Cameras will capture target image for data processing. On the back of the target, there's identification label for target position.

2.3 Communication Cable

X-881 PRO professional mobile wheel aligner has two cables between computer and lateral beam, one is USB data cable, and another one is power supply cable. Please keep them in good condition to avoid damage to the entire alignment system.

2.4 Turntable and Transit Bridge

X-881 PRO professional mobile wheel aligner comes with 2 mechanical turntables. Turntable shall be placed on the front wheel position on the lift. Each turntable has a pair of transit bridges and a pair of brake blocks, placed between the turntable and the lift, to ensure the vehicle move smoothly when do rolling compensation.

2.5 Steering Wheel Holder

X-881 PRO professional mobile wheel aligner is equipped with a steering wheel holder. During the test, it is required to place the steering wheel holder as prompted, to ensure the vehicle direction will not change during the process.

2.6 Brake Pedal Depressor

X-881 PRO professional mobile wheel aligner is equipped with a brake pedal depressor. It is used to press down the brake pedal, to prevent vehicle from moving at certain measurement stage, e.g., caster swing.

Chapter 3 Basic Operation Procedure

3.1 Pre-check

Ask the owner for vehicle drivability problems, symptoms, and wheel alignment history, and find out vehicle information such as country of origin, make, model and year, etc. Check each chassis part carefully, including dust cover, bearing, rock arm, tripod-ball, shock absorber, tie rod ball and steering mechanism, for any loose or wear. Then check whether the tire pressure, tire size and treads of the left and right wheels are alike. Communicate with the owner in case of any abnormal conditions found. Run the test together with the owner if necessary, to confirm the problem and take measures to ensure the accuracy of the measurement.

3.2 Alignment Measurement

Start the alignment measurement after the precheck.

3.3 Adjustment

In the alignment measurement, based on the measurement results, combined with the actual vehicle alignment fault phenomena, with reference of the OEM data, make corresponding adjustments according to the actual situation.

3.4 Test Run

Perform test drive after alignment adjustment is complete, to confirm if the fault phenomena are eliminated. Otherwise, redo the adjustment.

Chapter 4 Operation Instruction

4.1 Preparation before Test

- 1) Ask the owner for vehicle drivability problems, symptoms, and wheel alignment history, and find out vehicle information such as country of origin, make, model and year, etc., test drive the vehicle together with the owner if necessary.
- 2) Check and lock turntables and side slip plates, place the passing bridge, drive the vehicle onto the lift, letting front wheel about to be in the center of the turntable. When the vehicle is well on the desired position, center the steering wheel, lock the steering wheel with steering wheel holder. Place the wheel chock at the rear wheels to keep the vehicle from sliding, then release handbrake. Lift the vehicle up to the alignment height.
- 3) Check each chassis part carefully, including dust cover, bearing, rock arm, tripod-ball, shock absorber, tie rod ball and steering mechanism, for any loose or wear. Then check whether the tire pressure, tire size and treads of the left and right wheels are alike.
- 4) Mount the clamps and target onto the wheels, and lock the clamps.
- 5) Plug the power plug of the wheel aligner into a standard three-terminal power outlet.

4.2 Software Operation

Switch on the power, boot the computer, it will enter the main interface of the measurement program. There are 6 function buttons on the main interface: **Alignment Check**, **System Settings**, **General Settings**, **Report**, **Help**, **Exit**. See Figure 4.1:



Fig. 4.1

4.2.1 Alignment Check

Click **Alignment check** on the main interface to enter the measurement interface.

4.2.1.1 Select vehicle model

Before alignment measurement, reference vehicle data shall be selected, as shown below:

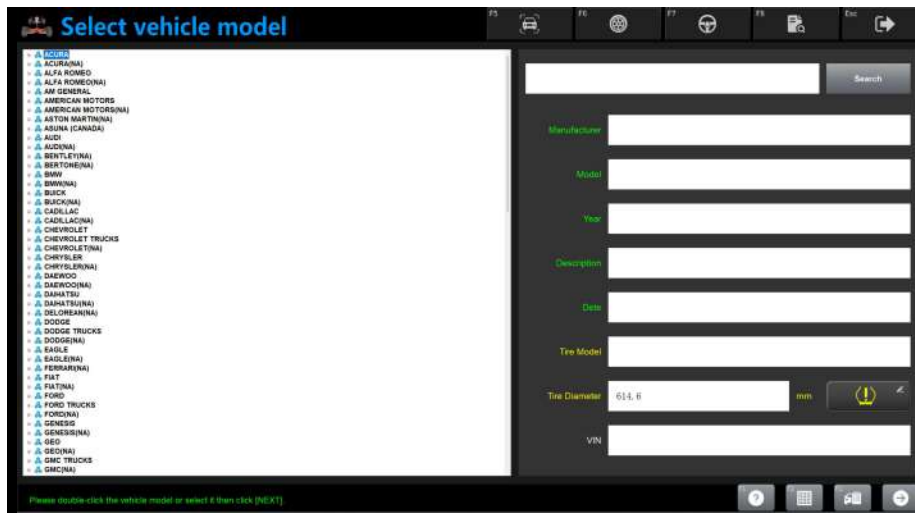

Fig. 4.2

| Item | Description |
|---------------------------------|--|
| Navigation Bar | Access to independent measurement steps instead of follow the default sequence. |
| Manufacturer, Model List | Select the desired model in the list for next step. If it's the first time to use, this list shall be empty. Click a certain manufacturer and select from the model list. |
| Quick Searching Box | Input box is provided at the top of the screen. Input the vehicle information to search the vehicle model quickly. |
| Help (F1) | Operation and tips for current page. |
| Target Monitor (F2) | Find out the reason in target monitor screen when system prompts target blocked. Or adjust the lateral beam height manually or automatically in this screen. |
| Quick Measurement (F3) | In case of unexpected exit after pushing or a secondary measurement after test drive, apply this quick measurement. However, the result might be a bit inaccurate as the rolling compensation is not yet done. |
| Next | To make the measurement follow the default sequence. |

After selecting the vehicle model, please double-click it or click **Next** to the display the following page as below:

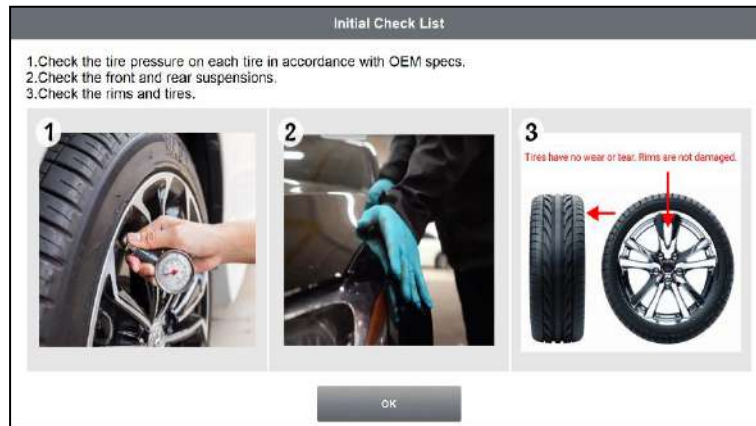

Fig. 4.3

Perform the inspection according to the initial check list and then click **OK** to enter the following page as below:

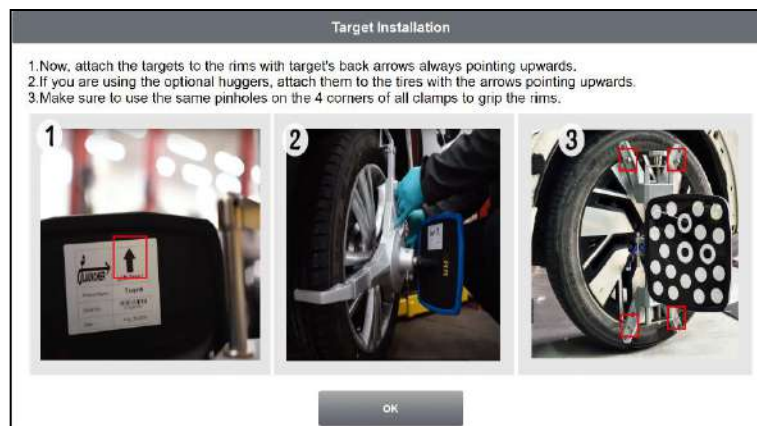

Fig. 4.4

Install the target according to the screen prompts and then click **OK** to enter the following page as below:

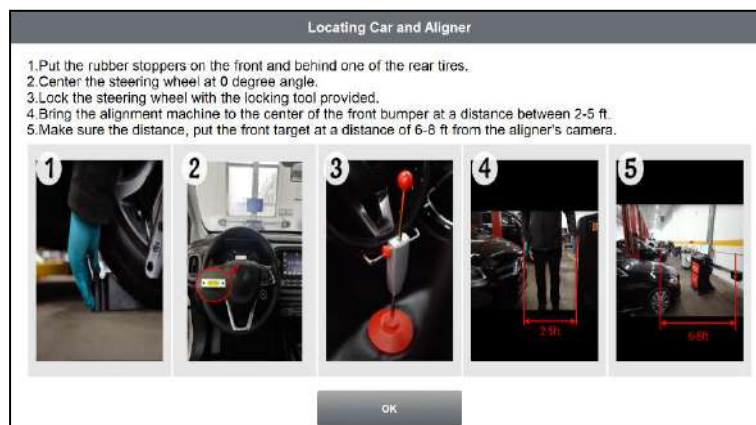

Fig. 4.5

Locate the vehicle and aligner according to the screen prompts and then click **OK** to enter the following page as below:

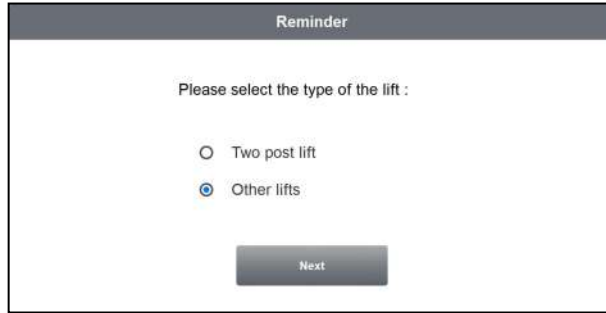

Fig. 4.6

Select the type of the lift (takes Other lifts as an example) and click **Next**.

Note: The Caster Swing test is not available for two post list.

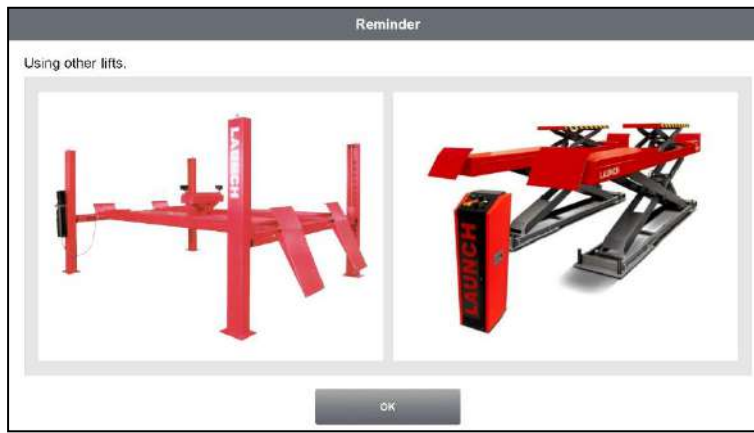

Fig. 4.7

Click **OK** to enter the following page as below:

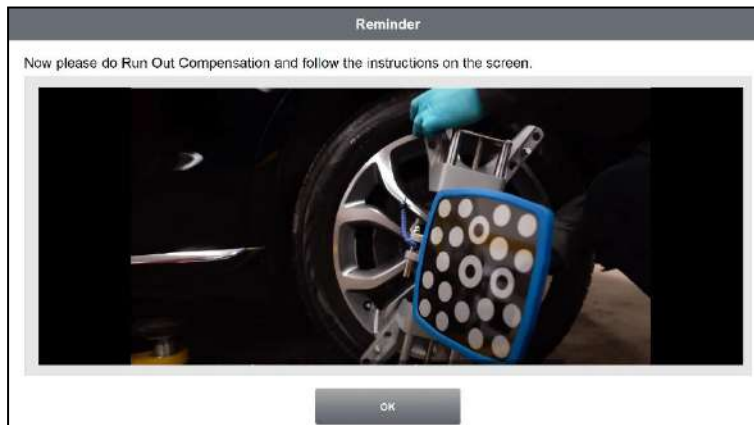

Fig. 4.8

Click **OK** to enter the following page as below:

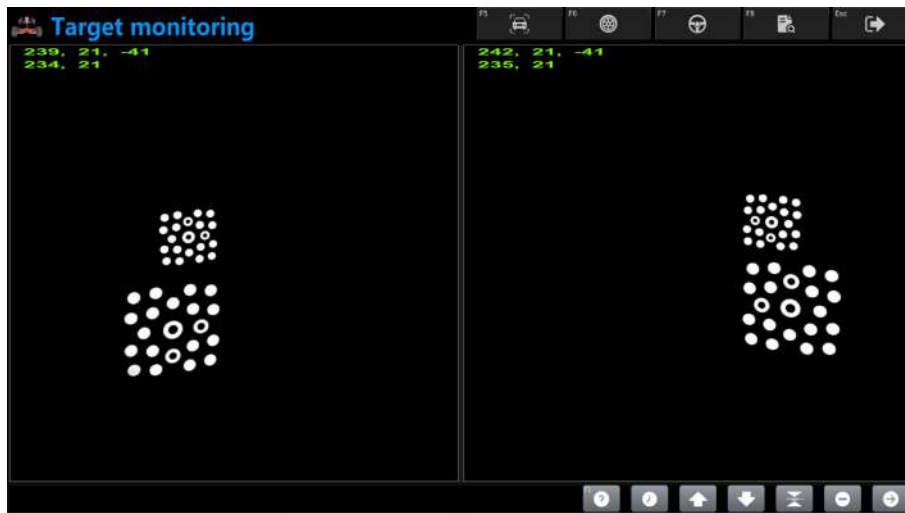

Fig. 4.9

Click **Next** to start the rolling run-out compensation.

4.2.1.2 Rolling Run-out Compensation

Rolling Run-out Compensation is to eliminate the error caused by the physical defect of rim and tire as well as the installation of clamps. Operation directly using wheel motion axis for alignment, the interface is as shown below:

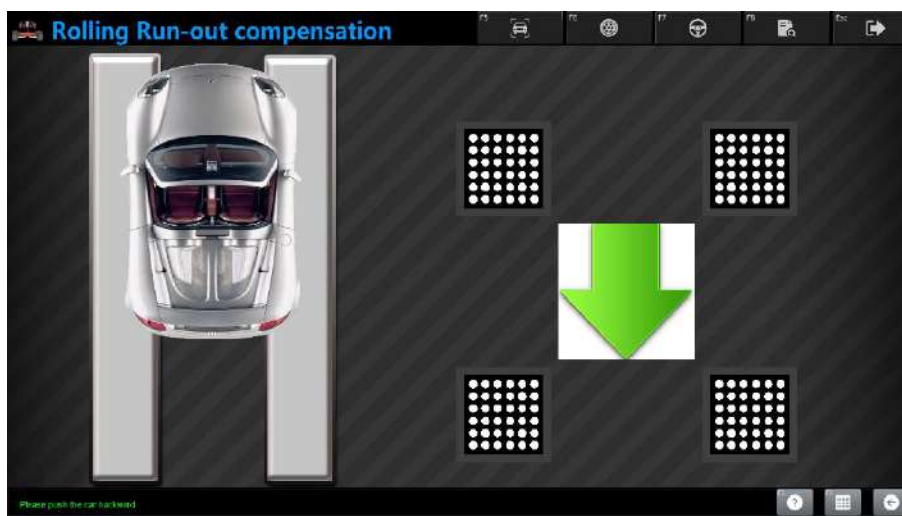

Fig. 4.10

| Item | Description |
|--------------------------------|--|
| Target red color status | This indicates the captured image is not applicable for measurement; possible reason shall be blockage between camera and target. |
| Help (F1) | Operation and tips for current page. |
| Target Monitor (F2) | Find out the reason in target monitor screen when system prompts target blocked. Or adjust the lateral beam height manually or automatically in this screen. |
| Previous | Return to the previous step to do the rolling compensation again. |

Operation Procedure:

- 1) Mount the clamps and targets.
- 2) Place the passing bridge to a proper position between the turntable and the lift.
- 3) Center the steering wheel and lock it with the steering wheel holder. Remove the brake pedal depressor, move the wheel chock about 15cm backward (if the wheel diameter is above 700mm, increase accordingly), allow the vehicle move freely within this range.
- 4) Push the vehicle back and forward as instructed by the system.

Caution:

- 1) *Before rolling compensation, the steering wheel shall be well locked to prevent wheels from swinging, causing unstable axis line.*
- 2) *When push vehicle back and forward, do not block the camera view.*
- 3) *Make sure the pushing is steady and stable.*
- 4) *The target initial position shall be vertical to the ground, otherwise, it may cause excessive target tilt angle, leading to abnormal target image.*
- 5) *Remove the passing bridge when rolling compensation finished.*

The screen will display real-time toe, camber of each wheel after push compensation. Adjust the wheel alignment data on this page if caster swing is not considered important. When do adjustment, to lift or lower the vehicle, operate the lift directly and the lateral beam will follow the lift to raise up or lower down, making the equipment always in best working condition.



Fig. 4.11

4.2.1.3 Caster Swing

Caster Swing is only for front wheels, including Caster and SAI. Correct SAI can equalize the loads applied on the bearings, so that the life of bearings can be prolonged and the controllability of steering is improved. The caster can make the intersection of the steering axis and the road surface forward of where the wheel contacts the ground, and generates a force to keep the vehicle go straight, the interface is as shown below:



Fig. 4.12

Operation Procedure:

- 1) Turn the steering wheel to make the wheel in straight-ahead position, the prompt ball will move to the central position and change from red to green.
- 2) Turn the steering wheel to the right or left, and make the right/left turn angle reaches or exceeds the setpoint (10 degree).
- 3) Turn the steering wheel back to the initial position as instructed. The ball turns green. Sampling work is done.

After calculation, the system will automatically prompt the result page for rear axle, as shown below:



Fig. 4.13

Click **Next** to display the result page for kingpin & front axle, as shown below:



Fig. 4.14

Click **Next** to display all test result page, as shown below:



Fig. 4.15

Adjust the wheel alignment data on this page. When do adjustment, to lift or lower the vehicle, operate the lift directly and the lateral beam will follow the lift to raise up or lower down, making the equipment always in best working condition.

Additional measurement: Measure track width, wheelbase, diagonal angle, etc. as shown below:

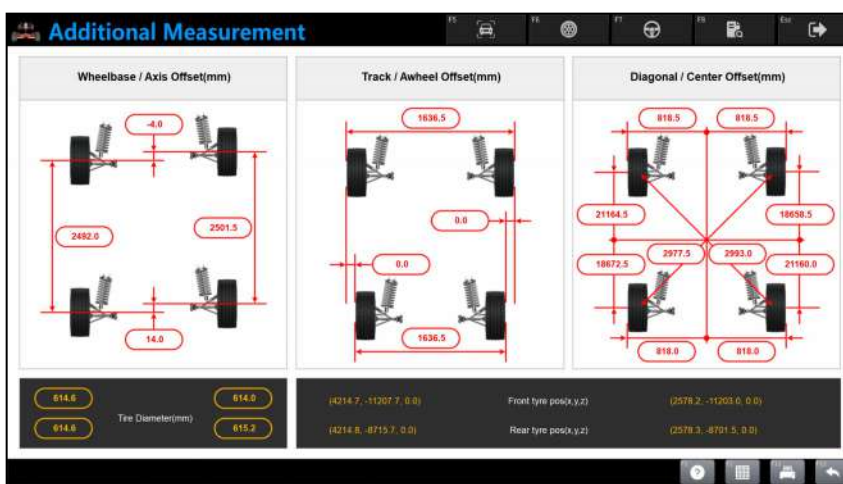

Fig. 4.16

Caution:

- 1) Before Caster Swing, be sure to mount the brake pedal depressor and remove the steering wheel holder.
- 2) On each measurement result page, the measurement result is displayed in different color.
 - 2-1) Green: Value within standard range;
 - 2-2) Red: Value beyond standard range;

4.2.1.4 Print Report

Print and save the current vehicle's alignment data, as shown below:

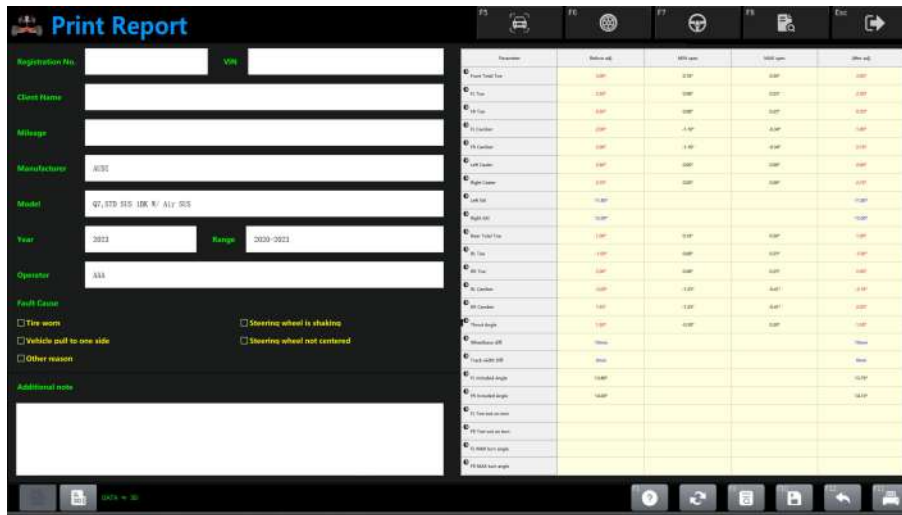

Fig. 4.17

| Item | Description |
|-------------------------------------|---|
| Registration No. | Registration number of current vehicle. |
| Client Name | Related information of vehicle owner. Client information could be entered directly with the keyboard on this page. |
| Vehicle Information | Related information of current vehicle, including travel mileage, manufacturer, model, start year, end year. Vehicle information can not be entered with keyboard on this page. If a vehicle model is selected beforehand, the corresponding vehicle information will be displayed. |
| Fault Cause | Current vehicle fault. Including: Tire worn, pull to one side, steering wheel not center, steering wheel shaking, and other causes. |
| View all test result (F9) | View all the data of wheels and kingpin. |
| Save (F10) | Save the current vehicle's alignment data (registration number shall be entered). |

Caution: The print function on this page is only applicable for the most recent measurement, while for historical report print, please access REPORT on the main interface.

4.2.1.5 Return

Return to main interface.

4.2.2 System Settings

Click **System Settings** on main interface to enter the system management page, as shown below:



Fig. 4.18

4.2.2.1 Repair Shop Information

Repair shop information is mainly used to record the workshop contact information and operator information. The information could be imported to the report, so the printed report could display the workshop information for data management and tracking service, as shown below:



Fig. 4.19

The content on this page is only editable when click **Edit** button. Click **Save** button after information edit, the system will automatically save the change and return to the previous page.

Caution: If there is more than one operator in the workshop, use '#' to separate different operator's name, e.g. Adam#Bob#David.

4.2.2.2 Client Information

Client Information manages client related information, for better follow-up service, the interface is as shown below:



Fig. 4.20

| Item | Description |
|---------------------------|---|
| Client Name Search | It's a quick index at the bottom of the screen. For Chinese, just input the first letter of the character spelling. |
| Add Client | Click this button to add client information by filling out the form popped up. |

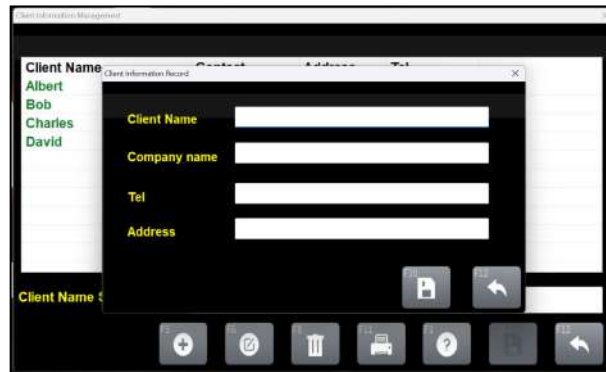

Fig. 4.21

| Item | Description |
|---------------|--|
| Edit | Click this button to modify/edit client information. |
| Delete | When delete a client entry, the system will delete all information including the measurement result of all the vehicles under his name. Please confirm before delete, since the data is not recoverable. |
| Print | Print client information list. |

4.2.2.3 Language Selection

Used to change the system language. Click the language icon to be changed, and then click **Save**.

Note: After changing into a new language, restart the program to make the settings take effect.



Fig. 4.22

4.2.2.4 OEM Data

This page provides OEM specs of vehicle alignment data. The database contains as many as possible records for various vehicles. Also the database can be updated by the system upgrade. In addition, it provides function to add user defined data, in case some vehicle alignment data is not included in the database, making the system more applicable for the workshop (**Note: Original user defined data won't disappear after database update**), interface is as below:



Fig. 4.23

| Item | Description |
|---------------------|--|
| Quick Search | It's a quick model index at the bottom of the screen. For Chinese, just input the first letter of the character spelling. |
| Add | To add vehicle data which not listed in the standard database, click this button, and add detailed user defined specs in the prompted window. Entered data will be stored in the standard database after confirmation. |
| Edit | This function is applicable for user defined data as well as the OEM specs. |
| Delete | This function is only applicable for user defined data, while the OEM specs are fixed, can not be deleted. |

Operation Procedure:

Directly select the manufacturer, and then the vehicle model to view the standard specs of this model.

4.2.2.5 Frequently Used Data Management

Frequently used data management could sort the most often used data out of the standard OEM specs, so as to speed up the information index, interface is as shown below:

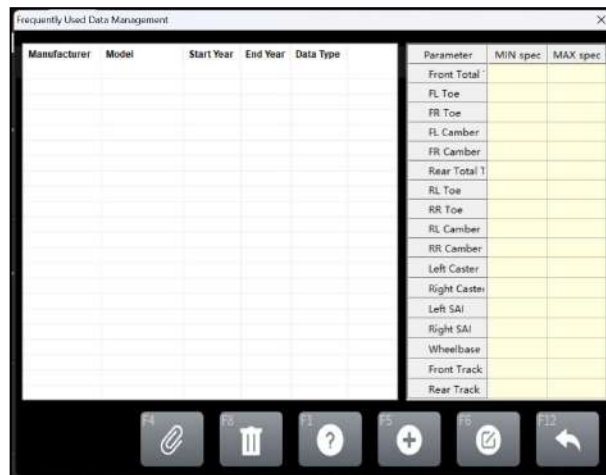

Fig. 4.24

| Item | Description |
|---------------------------|---|
| Add from OEM specs | Click this button to activate the OEM specs list, select the desired entry, confirm to add it into the frequently used data list. |
| Delete | This function is to delete record in frequently used data. |

4.2.2.6 Exit

Return to main interface.

4.2.3 General Settings

On the main interface, click **General Settings** to enter the setting page. On this page, some change could be made to the software to suit operator's need, interface is as shown below:



Fig. 4.25

4.2.4 Report Print

On the main interface, click **Report** to select the report type on the popped up window. There are 3 types could be selected: Data mode, 3D mode and Vehicle measurements.

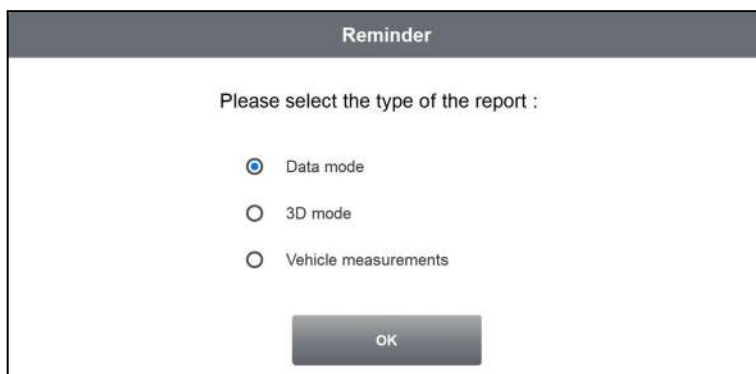

Fig. 4.26

Select **Data mode** and click **OK** to the interface where could navigate or print clients' service record.

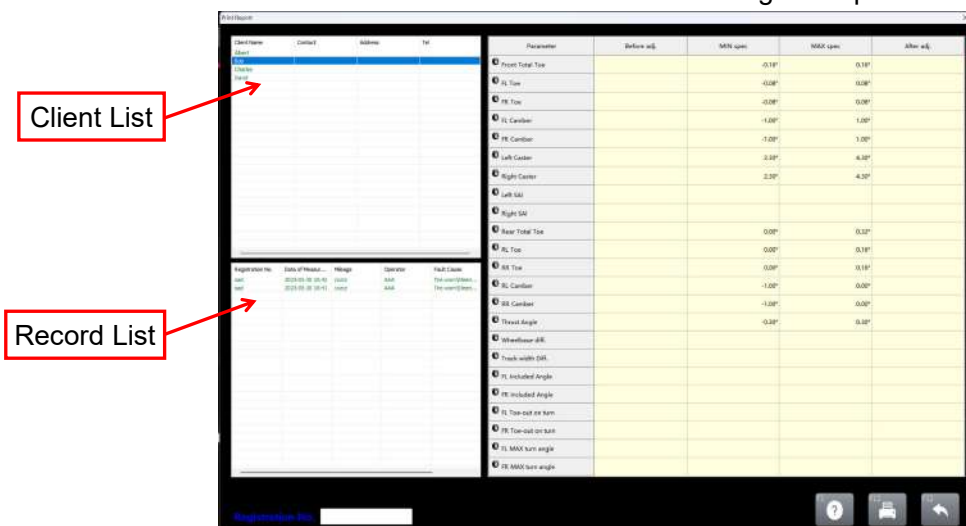

Fig. 4.27

| Item | Description |
|----------------------------|--|
| Client List | All client lists that did the alignment measurement. |
| Record List | Select a client entry in the Client List , it will display the service records. |
| Number Plate Search | Search with license number, to locate the measurement history of this vehicle. |
| Print | Print the alignment data of current vehicle. |

Select **3D mode** and click **OK**, the interface is as shown below:

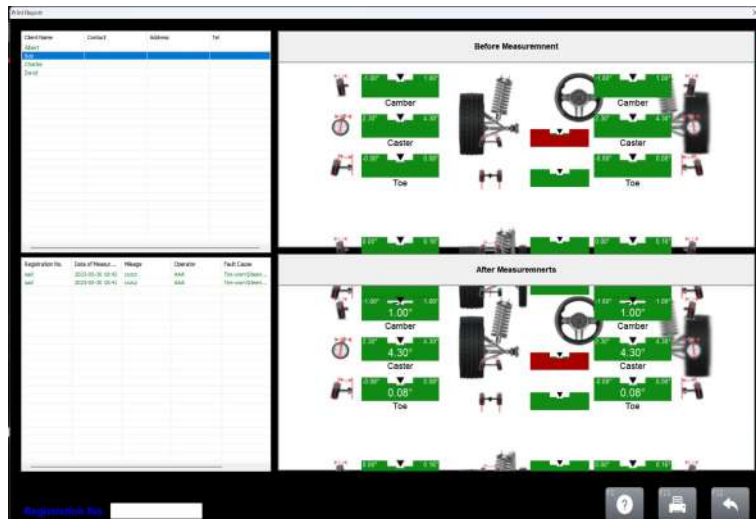

Fig. 4.28

Select **Vehicle measurement** and click **OK**, the interface is as shown below:



Fig. 4.29

4.2.5 Help System

Help system could provide detailed operation instructions, as shown below:

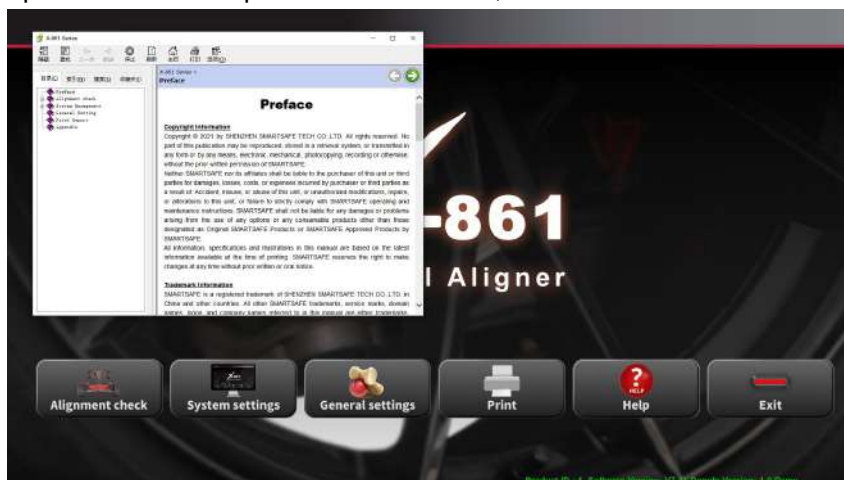

Fig. 4.30

4.2.6 Exit

Click to exit from the alignment software.

Chapter 5 FAQ

5.1 Computer Operation

5.1.1 Computer boot failure, no tips

- Check the power supply of the computer.
- Check whether the power button is pressed on both the computer host and monitor, whether the indication LED is flashing.
- Check the brightness and contrast of the monitor.

5.1.2 Failure to enter WINDOWS 7 desktop

- Computer boot file missing.
- BIOS error.
- Hardware failure.

5.1.3 Mouse or keyboard does not function

- Mouse/keyboard connection to the computer host is faulty.
- Mouse/Keyboard is not compatible with the computer host.
- Mouse/Keyboard is faulty.

5.1.4 Printer does not function

- Check the power supply of the printer, the signal cable connection to computer host, and whether the printer is in linked mode.
- Check installation and setting of the driver for the printer.
- Check whether the computer is virus affected.

5.1.5 Failure to run the wheel aligner software

- Software core file error or missing.
- Registry is damaged.

5.2 Standard Measurement

5.2.1. When turn the steering wheel, there's no camera/target block prompt when rear targets blocked. Why?

This is normal. It will not affect the measurement result. However, do not block any front target at extreme point, near 20°.

5.2.2. When turn the steering wheel, camera/target block prompt appeared when target light path blocked. How to handle?

If the block prompt appeared when within an area of 10°, please stop turning the steering wheel, remove the obstacles, then continue to turn the steering wheel.

5.2.3. After wheel alignment, the minimum turning radius of the wheel to the left and right is significantly different, why?

This is caused by the misalignment of the steering wheel and the steering column. The measurement of this equipment is based on the condition of "steering wheel centered". Before the measurement, ask the client for steering wheel related maintenance and service history, remove the misalignment, and make the steering wheel centered by experience.

5.2.4. Some target has no image in the target monitoring interface, why?

Check whether the light path between the corresponding camera and the corresponding target is blocked, whether the camera's lighting is illuminated, and its cable is properly connected. As the 2 sets of camera have the same hardware, exchange to troubleshoot the defective parts. Do remember to restore the system after exchange.

Chapter 6 Maintenance

6.1 Computer Maintenance

- Operator must have knowledge of computer software and hardware.
- The computer host should be installed in the case behind and below the column; the monitor should be firmly mounted on the socket above the workbench in front of the column. Do not place the computer host and/or monitor in a place with radioactive source and heat source, or in other environments where it is exposed to direct sunlight, heat, cold and humidity.
- Do not insert anything into the host and monitor through the gap.
- Do not move or violently shake the computer while it is working.
- Avoid frequent boot.
- Do not modify the BIOS settings.
- Do not delete the files you do not understand on the hard disk, to prevent the computer from abnormal operation or breakdown.
- The computer virus is hidden inside the computer system or attached to other files. It proliferates by copying itself, and damages and disturbs the normal operation of the system. The host computer is tested before leaving the factory, to ensure no virus exists.
- The host computer is dedicated for the wheel aligner. Do not use extraneous software on this equipment, to avoid virus infection. The warranty is expired automatically for any system problem due to virus infection.

- Regularly clean the host computer, monitor and keyboard with neutral detergent or anhydrous ethanol to get rid of the accumulated dust and oil contamination. Any contact with oily and corrosive substances is prohibited.
- Do not disassemble the computer, and disrupt the internal connection and PCB, to avoid damage.

6.2 Printer Maintenance

- Read the printer user guide carefully.
- Install correct printer driver, ensure the settings are correct.
- After a period of time, the print may be unclear. Change the printer cartridges in time.

6.3 Target and Clamp Maintenance

- Regularly clean the clamp and add a small amount of lubricant, to ensure the reliability.
- Regularly clean the target with neutral detergent or anhydrous ethanol to get rid of the accumulated dust and oil contamination. Water, oily and corrosive substances are prohibited.
- Target and clamp are the key parts for the measurement. Disassembly or mechanical deformation will severely affect the measurement result. The warranty is expired automatically for the damage due to unauthorized disassembly of the target and clamp.

6.4 Column, Lateral Beam and Signal Cable Maintenance

- Inside the lateral beam fixed above the column mounted high-precision cameras, which are calibrated at the first installation. Do NOT open or adjust the camera during or after operation. In case of camera problem, please do not hesitate to contact our distributors for maintenance or replacement.
- Protect the camera filters from dust. Gently wipe off the dirt with lens paper.

6.5 Turntable Maintenance

- Add a small amount of lubricant to ensure the flexibility of the turntable. When moving the vehicle on the turntable, do lock the turntable to avoid sliding.

Warranty

This WARRANTY applies only to customers and dealers who have purchased Launch Tech USA products through normal procedures.

Within one year from the date of delivery, Launch Tech USA Company shall guarantee the defects of its electronic products caused by materials or processes. Damage of the equipment or components caused by abuse, unauthorized modification, use for purposes other than the design of the product, or failure to operate in the way specified in the instruction shall not be covered by this warranty.

Disclaimer

The warranty mentioned above may supersede any other warranty.

Order notification

The replaceable parts and optional parts can be ordered directly from the dealers authorized by Launch Tech USA. Please specify when ordering:

- Quantity ordered
- Part number
- Part name

Customer Service Center

If the equipment needs to be repaired, please send the equipment to Launch Tech USA, together with the purchase invoice and problem description. If the equipment is within the scope of the warranty, Launch Tech USA offer free maintenance; If the equipment is outside the scope of the warranty, Launch Tech USA will charge for maintenance and return freight.

Address of Launch Tech USA Company:

LAUNCH TECH USA INC.

1820 S. Milliken Ave Ontario, CA 91761

Toll Free: 1-877-528-6249

Phone: 562-463-1580

E-MAIL: Support@launchtechusa.com

Statement: The Company reserves the right to change the product design and specifications without prior notice. The appearance and color of the object may be different from that shown in the instruction manual. The object shall prevail. We have tried our best to make all the descriptions in the book accurate, but there are still some inaccuracies. If you have any doubt, please contact the distributor or after-sales service center. The company will not assume any consequences caused by misunderstanding.

Warranty Card

Customer Name: _____ Tel. _____

Customer Address: _____

Distributor Name: _____ Tel. _____

Distributor Address: _____

Product Name: Professional Mobile Wheel Aligner Model: X-881 PRO

Product Number: _____ Date of Purchase: _____

Distributor (Signature): _____ Customer (Signature): _____

Records of Warranty (filled by service staff only)

| Date | Content | Customer Signature | Remark |
|------|---------|--------------------|--------|
| | | | |
| | | | |
| | | | |
| | | | |
| | | | |
| | | | |
| | | | |

Warranty







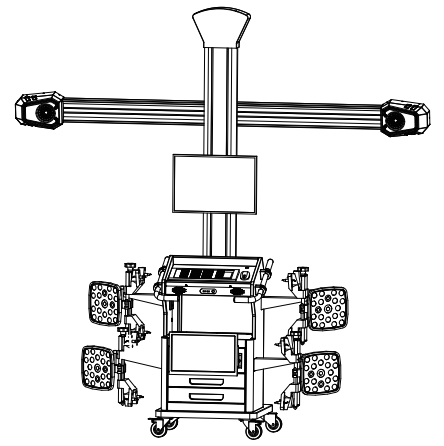

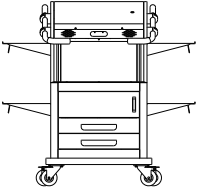

- I. Please read the terms and fill in this card carefully.
 - 1. Provide this warranty card for warranty service.
 - 2. 1 (one) year guarantee is provided for the overall unit, and three-year guarantee for the key components (camera, gear, rack, motor). Within the warranty, if any quality, manufacturing and software problem occurred during normal operation, free repair and parts replacement will be provided.
 - 3. For computer and printer, the manufacturer's warranty shall prevail.
- II. Damages caused by any of the following reasons are not covered by this warranty:
 - 1. Damage caused by improper operation.
 - 2. Artificial damage or accidental damage.

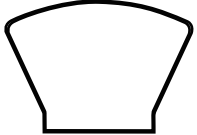
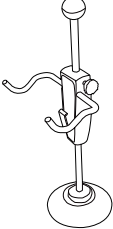
LAUNCH TECH USA

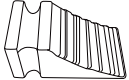
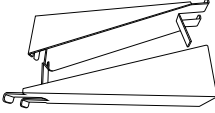
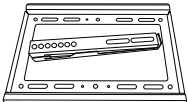
CREATE • CHANGE

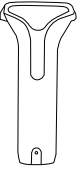
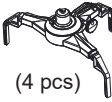
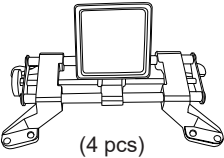

X-881 PRO Packing List

| | | | | | |
|-------------------------|--|-----------------------|--|------------------|---|
| Chassis |  | Column Assembly |  | Beam Assembly |  |
| Column Cap |  | Steering Wheel Lock |  | Brake Lock |  |
| Turntable |  | Wheel Chock |  (4 pcs) | Pylons |  |
| Monitor Bracket |  | Wifi Receiver |  | Wireless Scanner |  |
| Three Point Wheel Clamp |  (4 pcs) | Front Wheel Clamp Kit |  (4 pcs) | Monitor |  |
| Host |  | Printer |  | Packing List |  |