

## Table of Contents

<b>1. Introduction</b> .....	2
<b>1.1 Features</b> .....	2
<b>1.2 Safety Advice</b> .....	2
<b>1.3 Technical Data</b> .....	2
<b>2. Transport and Installation</b> .....	3
<b>2.1 Haulage and installation of the machine</b> .....	3
<b>2.2 Main shaft mounting</b> .....	3
<b>3. Identification of Functional Parts</b> .....	3
<b>3.1 Display panel</b> .....	3
<b>3.2 Control panel</b> .....	3
<b>3.3 Function conversion combination key</b> .....	4
<b>4. Operation</b> .....	6
<b>4.1 Start Machine</b> .....	6
<b>4.2 Wheel Mounting</b> .....	6
<b>4.4 Balancing mode selection</b> .....	8
<b>4.5 HID program</b> .....	10
<b>5. Maintenance and Repair</b> .....	11
<b>5.1 Self-calibration</b> .....	11
<b>5.2 Use a balanced wheel for self-calibration</b> .....	12
<b>5.3 Automatic gauge calibration</b> .....	12
<b>5.4 Self-inspection</b> .....	14
<b>5.5 Trouble shooting for the self-calibration</b> .....	14
<b>5.6. Wheel balancer trouble shooting</b> .....	14
<b>5.7 Self-check program (Check the position sensor and indicator)</b> .....	16
<b>6. The sensor structure and adjustment steps</b> .....	16
<b>7. Setting</b> .....	18
<b>8. Routine maintenance</b> .....	18
<b>8.1 Adjust the belt tension</b> .....	18
<b>8.2 Change fuse</b> .....	18
<b>9. Accessories</b> .....	19

## Copyright Information

All rights reserved! No part of this publication may be reproduced and stored in any form (electronic, mechanical, photocopying, recording or other forms) without obtaining written permission from Shenzhen Launch Tech Co., Ltd.(hereinafter refers to as LAUNCH). The manual is special written for the use of this machine of LAUNCH, therefore we are not responsible for any use of this information as applied to other devices.

Neither LAUNCH nor its affiliates shall be liable for damages, losses, costs, or expenses result from: user or third party's personal accident, misuse, or abuse of this unit, or unauthorized modifications, repairs, or alterations to this unit, or failure to strictly comply with LAUNCH operating and maintenance instructions.

LAUNCH shall not be liable for any damages or problems arising from the use of other accessories or parts other than original LAUNCH products or LAUNCH approved products.

Declaration: Other product names used herein are for identification purposes only and the registered trademark ownership belongs to original companies.

This equipment is intended for use by technical professionals or maintenance personnel.

## Trademark Information

**LAUNCH** is a registered trademark of LAUNCH TECH. CO., LTD. in China and other countries. All other LAUNCH trademarks, service marks, domain names, logos, and company names referred to in this manual are property rights of LAUNCH or its affiliates. In countries where any of the LAUNCH trademarks, service marks, domain names, logos and company names has not been registered, LAUNCH claims its ownership for them. Other trademarks referred to in this manual still belong to the original registered company. You may not use any trademark, service mark, domain name, logo, or company name of LAUNCH or other companies referred to in this manual without prior permission from the owners. You may contact LAUNCH by visiting its website at <http://www.cnlaunch.com>, or writing to Launch Industrial Park, North of Wuhe Rd., Banxuegang, Longgang, Shenzhen, Guangdong, P. R. China, if you have any questions.

## General Notice

Other product names used herein are for identification purposes only and may be trademarks of their respective owners. LAUNCH disclaims any and all rights in those marks.

## 1. Introduction

- The machine is a compute-based wheel balancer with easy operation, accuracy measuring, complete functions, security and reliability. This machine is used for automobile and motorcycle wheels (Rim diameter 12-26 inches, Rim width 1.5-20 inches).

### 1.1 FEATURES

- Using imported computer package and most advanced electric drive system
- High strength plastic hood ,in conformity with national safety operation standard. (Optional)
- In case of emergency situation, press “stop” key to stop the machine
- With OPT function, optimize the matching of tire and rim
- Mm/inch, British system and G/Oz transformation
- Many kinds of balancing mode
- Balancing precision  $\pm 1g$
- Failure diagnosis and self-calibration function
- HID function . to divide the balance weight and hide behind the spokes in a non-visible position
- 2D system, automatically input A and D value
- 3D system, automatically input A, D and L value(optional)

### 1.2 SAFETY ADVICE

- Voltage stabilizing power is recommended to use in the area where have not a stable power supply.
- Before starting to use the balancing machine, carefully read the operating instruction manual. Keep the manual in a safe place for future reference. Consult the technical person for any misunderstanding.
- Do not uninstall or replace the parts without the instruction of the technical person, otherwise the regular operation of the machine could be affected.
- Do not clean the machine by compressed air with exceeded pressure.
- Use detergent to clean plastic panels and shelves termly.
- The machine operator should not wear necktie, long hair or loose cloth. She or he should stand at the side face of the machine and make sure that unauthorized personnel do not approach the machine during the work cycle.
- The balancing machine should not be used for purposes other-than those described in the instruction manual.

- All the electrical installation should be operated by professional electrician .
- Make sure that the ground wire has a reliable ground connection, and cut off the power when the maintenance and repair operation is on.
- Never lift the machine with the spindle shaft when installation or operation, otherwise will lead the disrepair damage.
- Before the balancing operation, make sure the wheel is safety locked onto the shaft.

### **1.3 Packing Size and weights**

Packing size: 950 x 750 x 1160

Net weights: 125KG

Gross weights: 155KG

### **1.4 Applied range**

Rim diameter: 12-26 inches

Rim width :1.5-20 inches

Maximum wheel diameter: 800mm

Maximum wheel weight is: 65kg

## **2. TRANSPORT,AND INSTALLATION**

### **2.1 HAULAGE AND INSTALLATION OF THE MACHINE**

- To haulage the balancer, the chassis is the only recommended place to lift. Never lift the machine with the spindle shaft when installation or operation, otherwise will lead the disrepair damage.
- Install the balancer on the steady and smooth ground. It should keep 500mm distance away from the wall to maintain good air circulation. There are screw holes on the chassis. Anchor screw could be used to fix the machine on the ground. Measuring error could be brought due to unstable fixing.

### **2. 2 MAIN SHAFT MOUNTING**

Use alcohol or gasoline to clear the centre hole connecting the main shaft and adapter . Fix the adapter on the main shaft using a spanner.



Ensure that the “0” marks on the main shaft and the adapter are on a 12 O'clock position.

Use hexagonal spanner to fasten M14 bolt , otherwise ERR2 will displayed.

### 3. IDENTIFICATION OF FUNCTIONAL PARTS

#### 3.1 DISPLAY PANEL

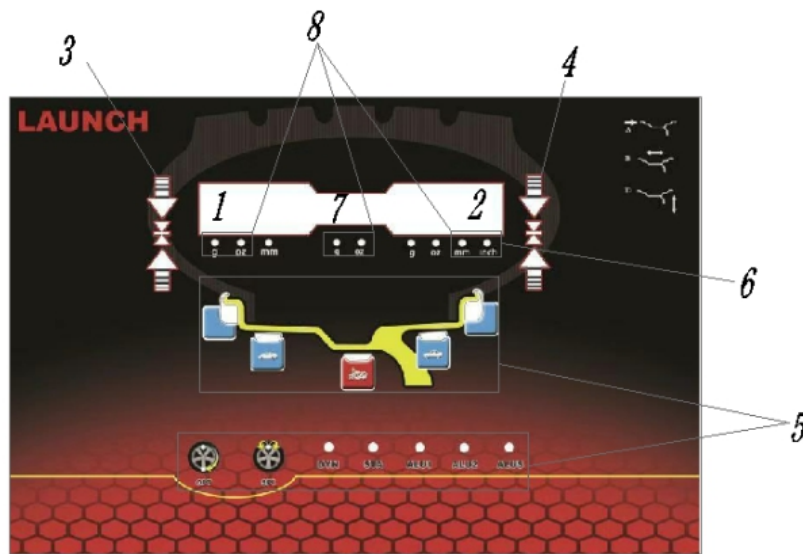

- 1—Left display screen, show AMOUNT OF UNBALANCE, inside, or A value
- 2—Right display screen, show AMOUNT OF UNBALANCE, outside, or D value
- 3—Indicate the position of inside unbalance (Inside counterbalance position indication)
- 4—Indicate the position of outside unbalance (Outside counterbalance position indication)
- 5—Indicate the balancing method
- 6— “mm/INCH” select
- 7—Middle display screen, show static value or rim width

8—"G/OZ" select

### 3.2 CONTROL PANEL

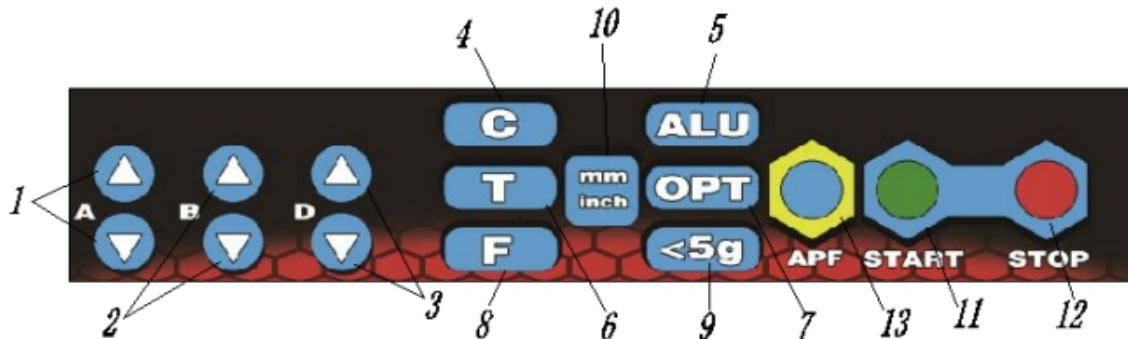

- (1)----"A" Manual input A value
- (2)----"B" Manual input B value
- (3)----"D" Manual input D value
- (4)----"C" self-calibration key /reset key
- (5)----ALU Alumina rim measure and dynamic balance select
- (6)----T test key, Test the balancer computer board
- (7)----OPT Optimize the match of tire and rim
- (8)----F Dynamic and static balance conversion key
- (9)----<5g show the actual unbalance value(<5g(0.3oz))
- (10)----mm/inch MM/INCH switch display
- (11)----START
- (12)----STOP
- (13)----"AOF" , automatic positioning function key.

### 3.3 FUNCTION CONVERSION COMBINATION KEY

#### 3.3.1 AFTER THIS OPERATION, EXIT AND SAVE

[STOP]+[a↑]+[a↓] Gram/ounce conversion key

[STOP]+[c] Put down the protection hood and start this machine

[STOP]+[5G] [STOP]+[5G] Calibrate the gauge A and D.

[C]+[T] Calibrate the weight value

[T]+[OPT] Input the spoke and divide the unbalance value

3.3.2 After the function conversion, the LED indicator lights on the panel, exit and do not save

[inch/mm]: inch/mm unit conversion

**Note: The default unit is inch.**

**Note: Use finger to press the button , clamp or other sharp matter are prohibited.**

## 4. Operation

4.1 After turn on the balancer, the software version number will be displayed on the screen, and then the three display Windows will display "8.0 5.0" 14.0" respectively.

### 4. 2 WHEEL MOUNTING

Before wheel balancing, remove the old balance leads and mud, coprolite or metal stuck in somewhere, such as the gaps in wheel. Make sure that the air pressure of the tyre accord with the standard value and there is no deformation on the rim locating surface and mounting hole. While balancer running, do not impact it to ensure the best testing result.

#### 4.2.1 Front Cone Mounting

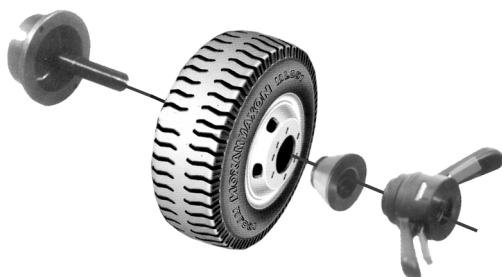

Almost all wheels , including normal steel rim and thin aluminum alloy rim, can be mounted using one of the front cones.

spindle shaft----wheel(rim attachment face inside)-----cone-----quick lock nut

#### 4.2.2 Back Cone Mounting

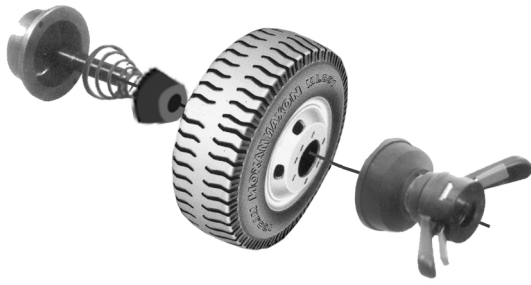

When the outside of the wheel have an obvious deformation, use the back cone mounting assure an accurate location between the inside hole of the rim and the shaft. That is suitable for some steel rim and some thick alumina alloy rim especially.

Main shaft—spring—cone(with the large end against the spring)—wheel—quick nut

**4.2.3 Special made flange mounting**



This mounting mode is used for the wheel with a center hole less than  $\Phi 135$

Adapter—big flange—wheel—big cone—quick nut

**Attention: Note: the cone should be suitable for the rim center hole, pay attention to the direction, else measurement error could be possible.**

**4.3.1 Input by hand**

Use key A、 B、 D, [ $\uparrow\downarrow$ ], input rim data.

**Attention: If the value on the display gradually light up, the internal gauge is not returned to zero position.**

**4.3.2 Automatic measurement of rim width**

1. When the measurement of rim spacing and rim diameter is completed, put down the tire hood, then the sonar external measure gauge begins to measure as shown below.



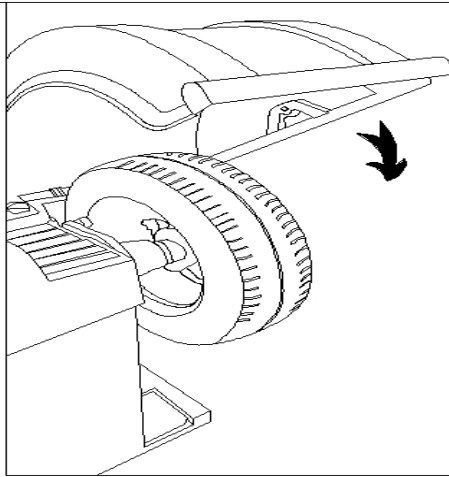

**Note: Confirm the completion of measurement through prompt tone.**

**2. Automatic positioning the disequilibrium point.**

After the the measurement, it will automatically find the disequilibrium point and lock it. At the same time, all the phase lights will be on and a prompt sound will be emitted.

**4.4 Balancing mode selection**

Press “F” key to select STA balancing mode, press “ALU” key to select other mode.

**4.4.1 DYN balancing mode**

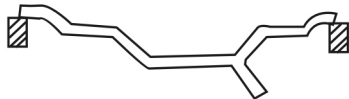

Dynamic balance— To eliminate the imbalance by clip-on the lead block at two points. It is suitable for steel or aluminum alloy wheel rim.

1. Mount the wheel onto the spindle shaft, input wheel data , put down the wheel cover or press [START] key to rotate the wheel, the result as bellowed:



2 Turn the rim until the 6 LEDs corresponding to outside panel light up: when the LEDs illuminate simultaneously, the point for application of the weight, at h12, has been located.

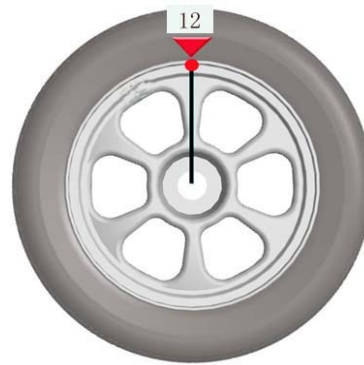

3. Apply a 30g weight on the rim at h12 position.
4. Repeat this operation for the inside part
5. Press [START] key, check the result.

**4.4.2 STA mode**



Static balance — The mode should be selected in the case of static rims or rims on which only one lead block is adhered on the rim. (e.g. Motorcycle wheel).

**4.4.3 ALU1、ALU2 mode**



ALU1 — It is suitable for the light alloy wheel rim. Adhere to these two lead blocks on the shoulders of the wheel rim.

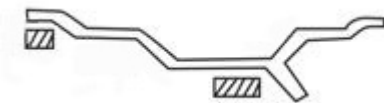

ALU2 — It is suitable for the light alloy wheel rim. Adhere to the lead block on the position showed in the fig.

**4.4.4 ALUS mode**

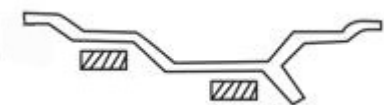

ALUS — Apply the weight to the rim on any position .

Activate the ALUS mode by internal gauge. Pull out the gauge from “0” position, and place its head on the first position (dl) of inside of the rim and keep the head touch with the rim for a few seconds ,wait

for the beep of confirmation. Go on pulling the gauge and place its head on the second position (dE), wait for the beep of confirmation. Release the gauge, ALUS mode is activated

By pressing ALU key, you could select ALUS mode.

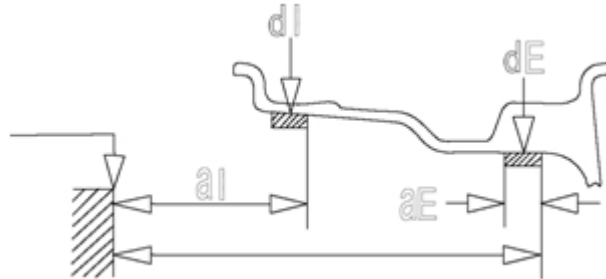

**Applying balancing weights:** Once the balancing program has been completed, the **INSIDE** and **OUTSIDE** panels of the display show the sizes of the balancing weights – inside and/or outside – to be fitted. Display Panel → shows the current balancing program: DYN, STA, ALU1, ALU2, When the programs are in use, the LED in the top of the display lights up.

To identify the points where the balancing weights have to be applied, with reference to the **INSIDE** and **OUTSIDE** panels of the display, turn the rim until the 6 LEDs corresponding to each panel light up: when the LEDs illuminate simultaneously, the point for application of the weight, at h12, has been located.

**Attention: Press key <<5g>, you could check the real unbalanced value**

For ALUS mode, to identify the points where the balancing weights have to be applied, you have to use internal gauge. After the measurement, A. D value displayed, turn the rim until the 6 LEDs corresponding to each panel light up, when the LEDs illuminate simultaneously, press down brake pedal to fix the wheel. Apply suitable weight to the gauge head, extract the internal gauge until “—□” displayed on the B window, and an intermittent beeper sounds when the application point is reached. Fit the weight.

To find the position for the second weight, repeat the procedure described above.

#### 4.5 HID program

The function for splitting the adhesive weight to be fitted in the well of the rim, when the ALU S balancing profiles are being used, is activated by pressing the T+OPT key on the panel.

The HIDE LED in the top of the display illuminates to indicate that the function has been activated.

##### **Procedure:**

1. Once the wheel spin has been performed to measure the weights to be applied, press the T+OPT key. The B window show the flashing message h12: turn the rim until the 6 LEDs of the OUTSIDE panel illuminate to display the weight application point, then confirm with ALU.
2. Window B → shows the message -1: position the spoke on the left of the application point at h12, and confirm with ALU.

3. Window B → shows the message -2: position the spoke on the right of the application point at h12, and confirm with ALU.
4. SPL displayed on the window B, Turn the rim until the 6 LEDS of the OUTSIDE panel light up. Using the internal gauge sensor, find the weight position. When the gauge is extracted, the B panel show the distance from the application point. “—□” displayed and an intermittent beeper sounds when the application point is reached. Apply the weight in the well of the rim( behind the left spoke) Repeat this operation , find another point. Apply the weight in the well of the rim( behind the right spoke)

## **Attention**

1. For the equipment using single phase power supply, when starting the operation push the wheel by hand one time to assist starting and prolonging service life.
2. Make sure the selected balance mode is suitable for the outline of wheel rim.
3. Make sure the lock nut is tightened.
4. Do not strike the spindle shaft when installing or removing the wheel.
5. When balancing the rim with a clip-on lead block, use a balancing weight to stick the lead block on the rim edge. After the balancing ends, strike it close on the ground. Do not strike it on the spindle shaft in order to avoid the damage of the sensor.; To keep the adhered lead block being stuck firmly, before adhering, you must clean the adhering surface and if it is needed should use the organic solvent or detergent.

## **5. MAINTENANCE AND REPAIR**

### **5.1 Self-calibration**

The self-calibration operation is finished in the manufacturer's plant. This operation could be re-do if the machine services too many years or the spares are charged or there is a big imbalance value. Install a middle-scale wheel(which has a rim diameter 14 or 15 inch) on the spindle shaft. Input the correct value of “A”, “L” and “d”.

**Note: The wheel chose for self-calibration should be in good condition and the value inputted should be correct else measure error could be possible.**

## 5.2 Use a balanced wheel for self-calibration

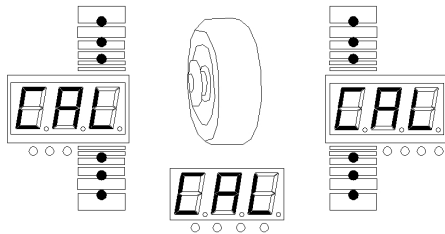

I Press “C” key, half of a second later, meanwhile press “T” key, “CAL ” – “CAL ’ displays on the control window, and all the indicators light and blink. Withdraw the fingers when all the indicators put out.

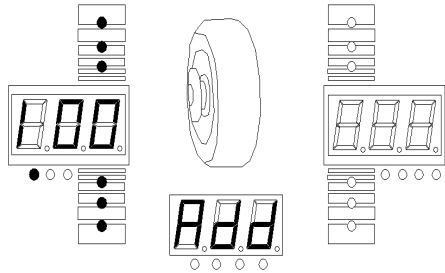

II Press “START” key, the wheel revolves and brakes automatically, “ADD” “Inn” “100” displays on the control window. Move the wheel until all six lights on left side are turned on. Attach an 100g weight at the highest vertical position (12 o'clock position) on the inner side of the rim.

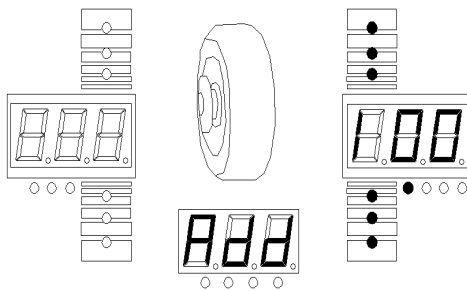

III Press “START” key, the wheel revolves and brakes automatically, ‘ADD’,’out’,‘100’ displays on the control window. Move the wheel until all six lights on the right side are turned on. Remove the weight from the inner side of the rim and attach it to the highest vertical position(12 o'clock position) on the outer side of the rim.

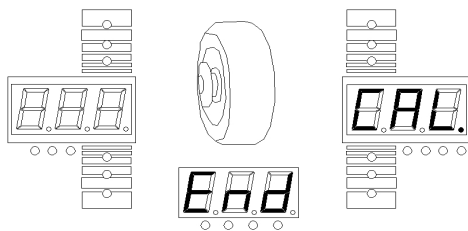

IV Press “START” key, the wheel revolves and brakes automatically. ‘CAL’ -‘END’ displays on the control window. The calibration is done.

## 5.3 Automatic gauge calibration:

- ① At 0 position, press [STOP]+[<5G], CAL 100 displayed
- ② Pull out the gauge, when it reaches “10” position, press “ALU”, “CAL ,d15, 235” displayed
- ③ Extract the internal gauge by 235 mm from the rest position, resting the gauge head on the outside edge of the flange on the threaded spindle. Press ALU key. “CAL” “dla” “15.0” displayed.
- ④ Press D key “↑”, D key “↓” to adjust the rim size for correction, pull the ruler so that the upper End of the ruler is in contact with the inside of the tire. Press “ALU” to confirm, and the displayer shows “CAL”, “End”.

- ⑤ 000 000 000 or the measured size displayed, indicating that the procedures carried out were correct.
- ⑥ If this operation is not OK, "CAL100" is displayed. Please calibrate it again.

**5.4 Self-inspection**

1. Press the "T" key and the indicator light flashes one by one from left to right. After the system detects the indicator light on the display screen, the display screen shows [POS.] [46]
2. Turn the tire and the indicator light starts to flash. When the initial tooth of the tooth disk on the spindle passes the sensor, the display screen shows [POS.] [00].
3. Every turn, the right screen will show once [00].
4. Press "ALU" to display [Inn] [456].
5. Press the tire and the value of the right window changes.
6. Press the "ALU" key to display [Inn] [454].
7. Press the tire and the value of the right window changes.
8. Press the "ALU" button, the display screen will display [dIs] [45].
9. Pull out the inside measuring stick and change the value of the right window.
10. Press the "ALU" key and the display screen will display [dIA] [845].
11. Swing the inside measuring ruler, and the value of the right window changes.
12. Press "ALU" to display [LAr] [00].
13. Lower the tire hood, the right window displays the measurement value of the outside measure gauge.
14. Press the "ALU" key to finish the self-inspection process.

**.5.5 Trouble shooting for the self-calibration**

Error	Description	Reasons
Display "E-rr-8"	1.Didn't clip-on the 100g lead 2.The electric connect wire of the pressure sensor is broken away 3.Computer board error. 4.Power board error	1. Perform calibration with 100g of standard lead 2.Check the connection and Connect the electric wire 3.Change a computer board. 4.Change a power board
The self-calibration performed by using a wheel has a too big imbalance value	1.The wheel has a big error value 2.These 3 EMS memory parameters disordered.	1.Use a balanced wheel 2.Amend the parameters

<p>When the self-calibration ends, there is too big imbalance value for the 100g lead block or the position is not on the positive down or too many lead blocks were used</p>	<ol style="list-style-type: none"> <li>1. The wheel has a big error value or there are something else on the wheel</li> <li>2. EMS memory dis, SFA value is error</li> <li>3. Unstable displayed value</li> </ol>	<ol style="list-style-type: none"> <li>1. Change a wheel</li> <li>2.1 Reduce the dis value if the displayed value is higher</li> <li>2.2 Increase the dis value if the displayed value is lower</li> <li>2.3 Reduce the SFA value if the lead block is at the right low position of the wheel.</li> <li>3. Refer to the trouble shooting</li> </ol>
---	---	---

Contact the professional if above methods do not work.

**Note:**  
**When changing computer panel, phase sensor or pressure sensor, self-calibration operation must be redone and the parameters must be reset in term of marked parameters inside the machine or primordial plate.**

**5.6 Wheel balancer trouble shooting**

Error Descriptions	Reasons	Solutions
Screen no display when starting	<ol style="list-style-type: none"> <li>1.The switch is broken</li> <li>2. External circuit is broken</li> </ol>	<ol style="list-style-type: none"> <li>1.Change another one</li> <li>2.Check the electric power circuit with multimeter.</li> </ol>
Display normal, but the machine can not start and with some noise, Err1 displays	<ol style="list-style-type: none"> <li>1.The capacitor of the electric machine is disabled</li> <li>2.380V power with no enough phase</li> </ol>	<ol style="list-style-type: none"> <li>1.Change capacitor 20UF/400V</li> <li>2.Check the power</li> </ol>
Err-1- displays	<ol style="list-style-type: none"> <li>1. Press "START", no stop.</li> <li>2. Press "START", no brake</li> </ol>	Check P.C. board, power board and photo electronic board
Err2	<ol style="list-style-type: none"> <li>1.The wheel is not installed</li> <li>2.Install the rim but with no tyre.</li> <li>3.The adaptor is not tightened.</li> <li>4.The wheel is not installed correctly or it is not tightened.</li> <li>5.The belt is over loose or tight.</li> </ol>	<ol style="list-style-type: none"> <li>1.Install the wheel</li> <li>2.Install the tyre</li> <li>3.Tighten the anchor screw</li> <li>4.Install a suitable adaptor</li> <li>5.Readjust the belt</li> </ol>

Err3	The wheel has a too big imbalance value	Change another wheel or do the self-calibration again.
Err4	1.If the wheel turned reversely, the phase wire is wrong connected. 2.If the wheel turned forward, the sensor is wrong.	1.Adjust the phase 2.Readjust the position or change another one
Err5	The wheel shield is not put down	Put down the shield
Err7	EMS memory data lose	Do the self-calibration again
Only display "00-00",no values displayed	1.The wire of the sensor is cut off or it is not well connected 2.EMS memory data lose	1.Connect the wire 2.Refer to the manual, correct the EMS memory value
The value of variable range exceeds 5 grams when the wheel turns.	1.The wheel is not clean or the fitting surface of the rim center hole is distorted 2.The sensor is wet or the lock nut is loose 3.The voltage is lower or the air pressure of the tyre is low or the adaptor is not tightened or the cabinet is not fixed on the ground.	1.Change a wheel 2.Drying it or readjust the sensor 3.Install voltage stabilizer; charge the tyre; tighten the flange or the adaptor by a lock nut; fix the cabinet on the ground.
The value of variable range reaches tens of grams when the wheel turns.	1.The wheel is not clean or the imbalance value is too big. 2.The sensor is out of action 3.The voltage is lower	1.Change a wheel 2.Check the sensor and the connection Check the power or install a voltage regulator
The electric machine can stop over ten seconds after the "START" key is pressed and there is a reading displayed on the window. But there is no brake signal.	1.The power board is damaged. 2.There is a disturb.	1.Change a power board. 2.Turn off the machine then reset it.
The balanced value is unstable. It is very hard to get the value "00".	1.The sensor is wet or it is damaged. 2.The program is disordered.	1.Readjust it, drying it and re-do self-calibration or change a sensor. 2.Re-do self-calibration.
The balancer can not brake when the value displayed.	1.The brake system is damaged. 2.There is a disturb.	1.Change a power board. 2.Reset the machine.
There is a difference value over 10g when the wheel is removed and installed.	1.The inner bore of the wheel is not clear or neat. 2.The adaptor is not well installed.	1.Change a wheel 2.Check the installed surface.
Err8 displayed when self-calibration is done.	See 5.1	



<p>Imbalance value exceeds hundreds of grams</p>	<p>1.These three EMS memory parameters are disordered. 2.The error value of the wheel is too big.</p>	<p>1.Readjust the value to the standard value in term of the manual. 2.Change a wheel</p>
--	---	---

**5.7 Self-check program** (Check the position sensor and indicator)

press<T>key, from left to right all the indicators light one by one, after all the indicators of display screen are examined, [ ] [POS] [ ] displayed. For checking the position sensor, rotate slowly the tire,

“1”indicators begin twinkling. When the “0” position of the tooth on the main shaft upper tooth disk pass the photoelectric sensor, “0” showed on the right display screen. Display [ ] [POS] [0]. Every circle finishes, [0]will show on the right display screen. When the tire turn in a negative direction, the indicators of “ALUS”twinkle .

**6. The structure of the sensor and the adjustment step:**

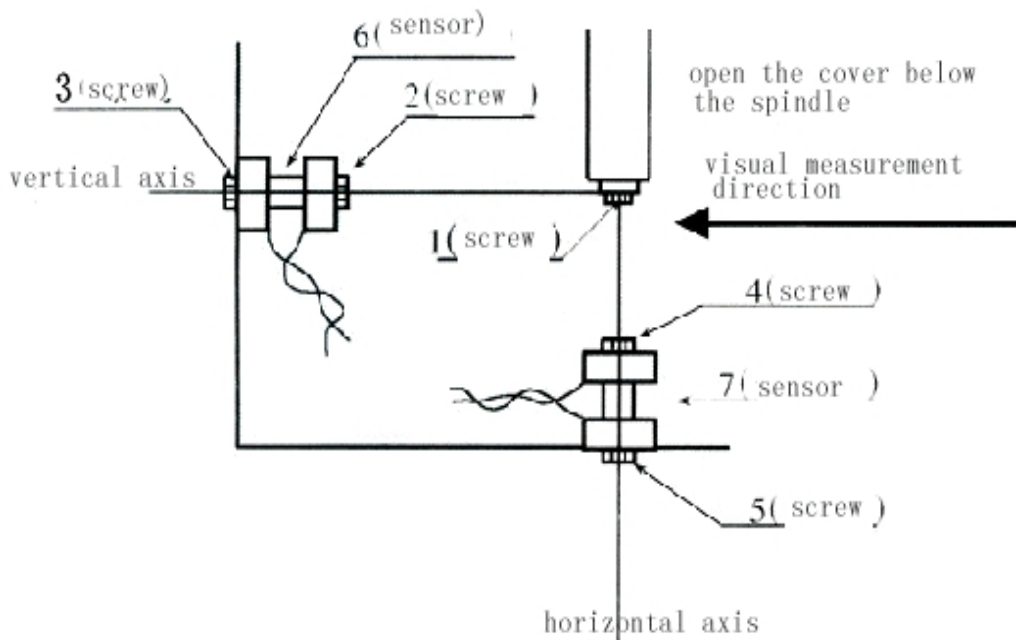

- ① unscrew nut 2、3、4、5
- ② unscrew nut 1,uninstall vertical axis

- ③take out sensor, check or change the pressure sensor
- ④install the sensor with long line onto the vertical shaft, install the sensor with short line onto the horizontal shaft, make sure the "+" pole of these two sensors is downward.
- ⑤assembly vertical shaft and horizontal shaft, screw the vertical shaft into the square steel by 1~1.5cm.
- ⑥adjust horizontal shaft to be parallel to the cabinet. Be careful, do not scratch the cabinet. tighten nut 1.
- ⑦adjust nut 2 or 3 to make sure the spindle shaft is vertical to the cabinet.
- ⑧tighten nut 4 by hand, then with a wrench, tighten it a half-turn. Then tighten nut 5.
- ⑨tighten nut 2 by hand, then with a wrench, tighten it a half-turn. Then tighten nut3.

**※after that job, short circuit the sensor joint to discharge electricity.**

**Attention: Before any service job, turn off the machine. And after that,make fatigue test.**

Step: Mount a 15" wheel, short circuit pins 1 and 4 on the computer board to let the machine run automatically, 15 minutes later, turn off the power. 30 minutes later, turn on the power, repeat this operation 5 times.

### 7.Seting

If the program is lost due to operation error or other reasons, the following adjustments can be made to restore the computer to work.

Note: Correct parameters setting can ensure the balance accuracy.

1. Hold down the "C" key and hold down the "T" key for half a second. The display window shows that the phase indicator of "CAL, CAL" is fully on and flashing, and release the button when the indicator does not flash

2. Press A key "↑", A key "↓" and AUL button in order. The window displays "Re" and "05".

Parameter categories are displayed on the left window and parameter values are displayed on the right window.

Function	keys
Change Settings/value	"B" Key: "↑""↓"
Enter the next setting	"A " key: "↑"

Setting	Left window	Right window	Instruction
Residual grams	re	05	Set do not to display residual grams
Internalmeasure gauge compensatio	da.-1	000	Adjust the compensation value of internal measure gauge
Outside measure gauge compensation	db.	000	Adjust the compensation value of the outside measure gauge.
Upper and lower laser switch	LAS	OFF	Upper and lower laser switch function

## 8. Routine maintenance

**Note: Non-professional person should not allowed to operate**

Cut off the power

### 8.1 Adjust the belt tension

8.1.1 Demount the weight tray;

8.1.2 Lose the screw fixing motor, move the motor to adjust the belt;

8.1.3 Tighten the screw, mount the weight tray.

### 8.2 Change fuse

Pull out the broken fuse on the power board and insert a new one.

### 9. ACCESSORY



7015 quick nut



2003 adaptor



7001 balance hammer



7006 bowl



7006 spring



M14\*240 bolt



6mm-12mm spanner



7008 calipers



7012 cone1



7011 cone2



7010 cone3



Cone 4



WEIGHT REMOVAL TOOL

