

Trademarks

LAUNCH is a registered trademark of LAUNCH TECH CO., LTD. in China and other countries. All other marks are trademarks or registered trademarks of their respective holders.

Copyright Information

Copyright © 2021 by LAUNCH TECH CO., LTD. (also called LAUNCH for short). All rights reserved. No part of this publication may be reproduced, stored in a retrieval system, or transmitted in any form or by any means, electronic, mechanical, photocopying and recording or otherwise, without the prior written permission.

Statement: LAUNCH owns the complete intellectual property rights for the software used by this product. For any reverse engineering or cracking actions against the software, LAUNCH will block the use of this product and reserve the right to pursue their legal liabilities.

Disclaimer of Warranties and Limitation of Liabilities

All information, illustrations, and specifications in this manual are based on the latest information available at the time of publication.

The right is reserved to make changes at any time without notice. We shall not be liable for any direct, special, incidental, indirect damages or any economic consequential damages (including the loss of profits) due to the use of the document.

Important Safety Precautions

To avoid personal injury, property damage, or accidental damage to the product, read all of the information in this section before using the tool.

DANGER

- When an engine is operating, keep the service area well-ventilated or attach a building exhaust removal system to the engine exhaust system. Engines produce various poisonous compounds (hydrocarbon, carbon monoxide, nitrogen oxides, etc.) that cause slower reaction time and result in death or serious personal injury.
- Please use the included battery and power adaptor. Risk of explosion if the battery is replaced with an incorrect type.
- DO NOT attempt to operate the tool while driving the vehicle. Have second personal operate the tool. Any distraction may cause an accident.

WARNING

- Always perform automotive testing in a safe environment.
- Do not connect or disconnect any test equipment while the ignition is on or the engine is running.
- Before starting the engine, put the gear lever in the Neutral position (for manual transmission) or in the Park (for automatic transmission) position to avoid injury.
- NEVER smoke or allow a spark or flame in vicinity of battery or engine. Do not operate the tool in explosive atmospheres, such as in the presence of flammable liquids, gases, or heavy dust.
- Keep a fire extinguisher suitable for gasoline/chemical/electrical fires nearby.
- Wear an ANSI-approved eye shield when testing or repairing vehicles.
- Put blocks in front of the drive wheels and never leave the vehicle unattended while testing.
- Use extreme caution when working around the ignition coil, distributor cap, ignition wires and spark plugs. These components create hazardous voltage when the engine is running.
- To avoid damaging the tool or generating false data, please make sure the vehicle battery is fully charged and the connection to the vehicle DLC (Data Link Connector) is clear and secure.
- Automotive batteries contain sulfuric acid that is harmful to skin. In operation, direct contact with the automotive batteries should be avoided. Keep the ignition sources away from the battery at all times.
- Keep the tool dry, clean, free from oil, water or grease. Use a mild detergent on a clean cloth to clear the outside of the equipment when necessary.

- Keep clothing, hair, hands, tools, test equipment, etc. away from all moving or hot engine parts.
- Store the tool and accessories in a locked area out of the reach of children.
- Do not use the tool while standing in water.
- Do not expose the tool or power adapter to rain or wet conditions. Water entering the tool or power adaptor increases the risk of electric shock.
- This tool is a sealed unit. There are no end-user serviceable parts inside. All internal repairs must be done by an authorized repair facility or qualified technician. If there is any inquiry, please contact the dealer.
- Keep the tool far away from magnetic devices because its radiations can damage the screen and erase the data stored on the tool.
- Do not attempt to replace the internal rechargeable lithium battery. Contact the dealer for factory replacement.
- Do not disconnect battery or any wiring cables in the vehicle when the ignition switch is on, as this could avoid damage to the sensors or the ECU.
- Do not place any magnetic objects near the ECU. Disconnect the power supply to the ECU before performing any welding operations on the vehicle.
- Use extreme caution when performing any operations near the ECU or sensors. Ground yourself when you disassemble PROM, otherwise ECU and sensors can be damaged by static electricity.
- When reconnecting the ECU harness connector, be sure it is attached firmly, otherwise electronic elements, such as ICs inside the ECU, can be damaged.
- Because there are various procedures, techniques, tools, and parts for servicing vehicles, as well as the skill of the person doing the service work, the technician must be well knowledgeable of the vehicle and the system being tested.
- The vehicle parts and the X-PROG 3 components are welded at a constant temperature.
- When welding vehicle parts with the X-PROG 3 components, the unit is powered off and is grounded.

TABLE OF CONTENTS

1 Introduction	1
1.1 Product Profile.....	1
1.2 Technical Specifications.....	1
1.3 Package List.....	2
2 Components & Controls	3
2.1 Display Tablet	3
2.2 SmartLink C Device	4
3 Initial Setup	6
3.1 Charging the Tablet.....	6
3.2 Power On/Off	6
3.3 Screen Layout	6
3.4 Adjusting Screen Brightness	6
3.5 Changing Language.....	7
3.6 Network Setup.....	7
4 Getting Started	8
4.1 Register & Update.....	8
4.2 Home Screen	9
4.3 Vehicle Menu Layout.....	10
4.4 Diagnostics Toolbar	11
4.5 Connections	11
4.5.1 Preparation.....	11
4.5.2 Vehicle connection	12
5 Key Immobilizer & Immobilizer Programming	13
5.1 Key Immobilizer (IMMO)	13
5.1.1 Vehicle connection	13
5.1.2 Immobilizer operations	14
5.2 Immobilizer Programming (IMMO PROG)	17
6 Diagnosis	18
6.1 Intelligent Diagnose.....	18
6.2 Local Diagnose	20
6.2.1 Health report (Quick Test)	22
6.2.2 System scan.....	24
6.2.3 System selection	24
6.2.4 ADAS calibration	30
6.3 Remote Diagnose	30
6.3.1 X-431 Remote Diagnose.....	30
6.3.2 SmartLink Diag.....	36
5.4 Diagnostic History	42
5.5 Feedback	42
6 Special (Reset) Function	44
6.1 Oil Reset Service	44
6.2 Electronic Parking Brake Reset	45
6.3 Steering Angle Calibration	45
6.4 ABS Bleeding.....	45

6.5 Tire Pressure Monitor System Reset	45
6.6 Gear Learning	45
6.7 Injector Coding	46
6.8 Battery Maintenance System Reset.....	46
6.9 Diesel Particulate Filter (DPF) Regeneration	46
6.10 Electronic Throttle Position Reset	46
6.11 Gearbox Matching.....	46
6.12 AFS (Adaptive Front-lighting System) Reset	46
6.13 Sunroof Initialization.....	46
6.14 Suspension Calibration	47
6.15 EGR Adaption	47
6.16 Windows Calibration	47
6.17 Seats Calibration.....	47
6.18 Tyre Reset.....	47
6.10 Language Change.....	47
6.20 A/F Reset	47
6.21 Coolant Bleed.....	47
6.22 Transport Mode.....	47
6.23 AdBlue Reset (Diesel Engine Exhaust Gas Filter)	47
6.24 NOx Sensor Reset	47
6.25 Stop/Start Reset.....	47
7 Software Update.....	48
7.1 Update Diagnostic Software & APP	48
7.2 Update IMMO&IMMO PROG Software.....	48
7.3 Renew Subscription	48
8 HD Software Package Purchase/Renewal	50
9 Other Modules	51
9.1 ADAS (Calibration).....	51
9.2 TPMS	51
9.3 User Info.....	51
9.3.1 My Report.....	51
9.3.2 VCI	51
9.3.3 Activate VCI.....	51
9.3.4 Fix Connector Firmware/System.....	51
9.3.5 Sample	51
9.3.6 Vehicle Voltage.....	51
9.3.7 My Order	51
9.3.8 Subscription Renewal Card.....	52
9.3.9 Profile	52
9.3.10 Change Password.....	52
9.3.11 Settings	52
9.3.12 Diagnostic Software Clear.....	55
9.4 Toolbox	55
9.4.1 Oscilloscope.....	55
9.4.2 Sensor Simulator.....	56
9.4.3 Multimeter	56

9.4.4 Battery Tester	56
9.4.5 Videoscope	56
9.5 TeamViewer	56
9.6 Wireless Upgrade.....	56
9.7 File Explorer	57
9.8 Gallery	57
10 J2534 Reprogramming Using SmartLink C	58
10.1 As a Local J2534 PassThru Device	58
10.2 As a Remote J2534 PassThru Device	58
11 Synchronization	60
12 FAQ.....	61
12.1 About X-431 IMMO PAD	61
12.2 About SmartLink Diag.	62
13 Glossary of Terms & Abbreviations	63

1 Introduction

1.1 Product Profile

This Android OS-based, tablet-style diagnostic tool incorporates the best possible coverage of OE-level diagnostics with multitasking capable software.

Using the powerful 8-core 2.0GHz processor and a 10.1 inch sunlight readable capacitive touch screen with a resolution of 1920 x 1200 pixels, it delivers quick and complete diagnostic functionalities which technicians need to diagnose, research and repair vehicles in one solution.

It has the following features:

- **IMMO (Immobilizer):** This function enables you to perform the anti-theft key matching function, so that the immobilizer control system on the car identifies and authorizes remote control keys to normally use the car.
- **IMMO PROG (Immobilizer Programming):** This function allows you to read transponder data and generate exclusive keys, and read/write on-board EEPROM chip data and MCU/ECU chip data. X-PROG 3 is required when performing this function.
- **Intelligent Diagnose:** This module allows you to use the VIN information of the currently identified vehicle to access its data (including vehicle information, historical diagnostic records) from the cloud server to perform quick test.
- **Local Diagnose:** VINscan quick test and manual diagnosis are available. Diagnosis functions include: Read DTCs, Clear DTCs, Read Data Stream, Special Functions etc.
- **Remote Diagnosis:** This option aims to help repair shops or technicians launch instant messaging and remote diagnosis, making the repair job getting fixed faster.
- **Reset:** All kinds of common maintenance and reset items including Oil lamp reset, DPF regeneration, ABS bleeding can be done.
- **One-click Update:** Lets you update your diagnostic software online.
- **Diagnostic History:** This function provides a quick access to the tested vehicles and users can choose to view the test report or resume from the last operation, without the necessity of starting from scratch.
- **Diagnostic Feedback:** Enables you to submit the vehicle issue to us for analysis and troubleshooting.
- **ADAS:** This function enables users to perform ADAS (Advanced Driver Assistance System) calibration operations.
- **Pre- and Post- Repair Result Comparison:** By comparing the pre-repair and post-repair report, you can clearly determine which vehicle issues have been fixed and which remained unsolved.
- **Vehicle Coverage:** Quick dial to view the vehicle models that the tool covers.
- Equipped with USB port for working together with other add-on modules such as Oscilloscope, Sensor simulator, Battery tester and Videoscope.

1.2 Technical Specifications

1. Display tablet

CPU	8-core Processor, 2.0GHz
Display	10.1 inch touch screen with a resolution of 1920 x 1200P
Memory	4GB
Hard Disk	64GB
Connectivity	<ul style="list-style-type: none"> • Wi-Fi (802.11 b/g/n/ac) • Universal serial BUS Ports (1 x Type-C + 1 x Type-A)
Camera	8MP front-facing camera + 13MP rear-facing camera
Sensor	<ul style="list-style-type: none"> • Gravity Accelerometer • 3-Axis Acceleration Sensor

Operating Temp.	0°C ~ 50°C
Storage Temp.	-20°C ~ 70°C

1.3.2 VCI (Vehicle Communication Interface)

Size	204mm x 110mm x 45mm
Working voltage	DC 9 ~36V
Memory	256MB
Hard disk	8GB
Typical power consumption	≤ 6W
Communication	<ul style="list-style-type: none"> • Bluetooth/Wi-Fi or data cable connection (for Diagnostics) • Ethernet (only for SmartLink Diag.)
Working temperature	0°C ~ 50°C

1.3 Package List

The following packing list is for reference purpose only. For different destinations, the accessories may vary. For details, please consult from the local dealer or check the packing list supplied with this tool together.

No.	Item	Description	Qt.
1	Display tablet	Indicates the test results.	1
2	SmartLink C	Connects to vehicle's DLC port to access vehicle's live data.	1
3	OBD II extension cable	Connects the VCI for extension purpose.	1
4	OBD I adaptor	Connects the non-16pin connector to the VCI.	1
5	Cigarette lighter cable	Supplies power to the non-16pin connector through connection to the vehicle's cigarette lighter receptacle.	1
6	Battery clamps cable	Supplies power to the non-16pin connector through connection to the vehicle's battery.	1
7	Crossover cable	Connects the SmartLink C device to the modem.	1
8	Power adaptor	Charges the tablet.	1
9	Data cable	Connects the VCI to the tablet to perform vehicle diagnosis.	1
10	Password envelope	A piece of paper bearing Product S/N and Activation Code, which is needed for product registration.	1
11	Non-16pin adaptor cable kit	Connects to non-OBD II vehicle DLC port (For more detailed adaptor cables, refer to the package box).	1
12	X-PROG 3 immobilizer programmer kit	Includes the X-PROG 3 and the accessory.	1

2 Components & Controls

There are two main components to the X-431 IMMO PAD system:

- Display Tablet – the central processor and monitor for the system (See Chapter 2.1).
- VCI – the device for accessing vehicle data (See Chapter 2.2).

2.1 Display Tablet

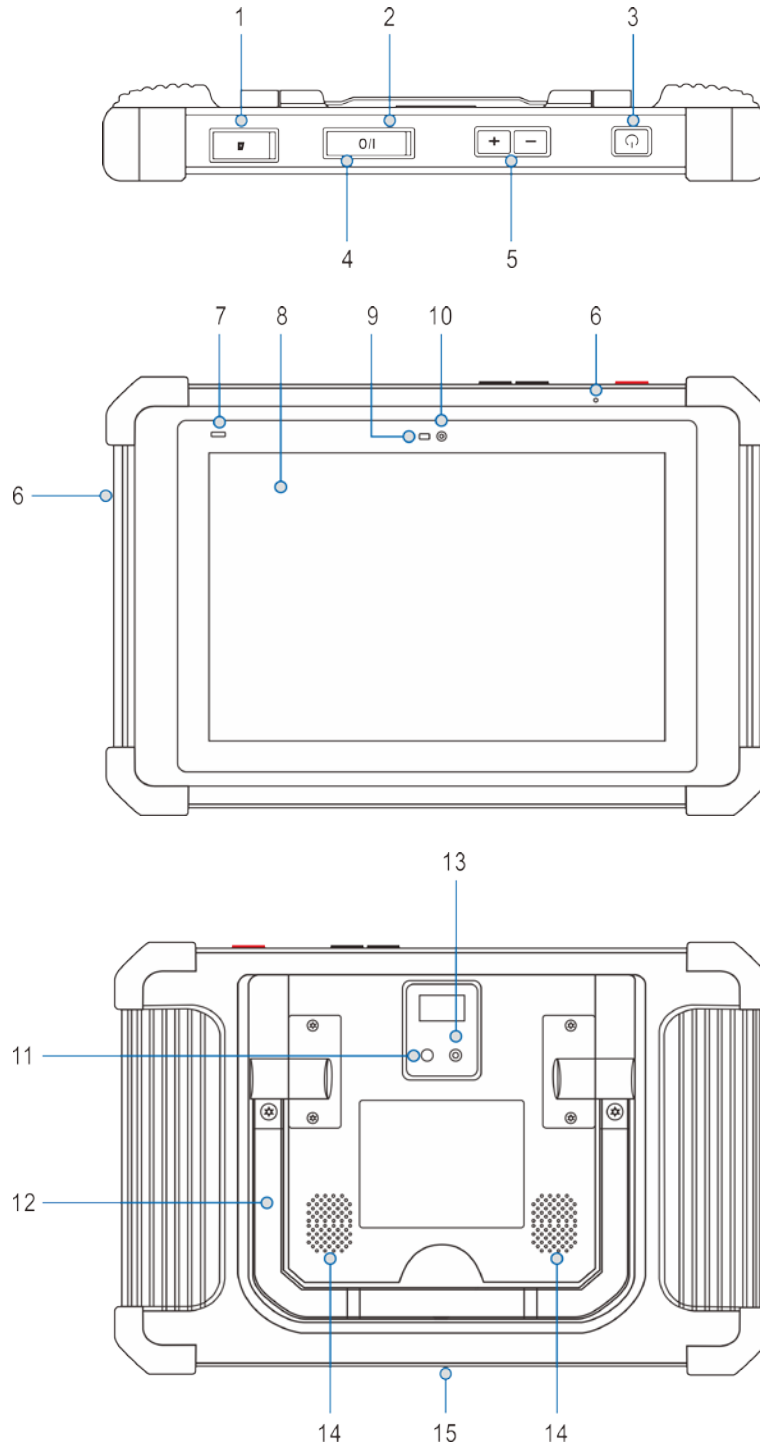

- | | | |
|---|-------------------------|---|
| 1 | Memory Card Slot | Insert a memory card for storage extension. |
| 2 | Charging Port | Charge the tablet. |

3	Power/Screen Lock Button	To turn the tablet on/off with long press, or lock the screen with short press.
4	USB Port	Reserved for add-on modules and other devices with similar port.
5	Volume Buttons	Adjust the volume. *Note: Press and hold [POWER] and [VOL -] key to capture the current screenshot.
6	Microphone	Convert voice into an electrical signal.
7	Charging LED	It illuminates red while the tablet is charging. Once charging is finished, it will illuminate solid green.
8	Touch Screen	Indicate the test results.
9	Ambient Light Sensor	Sense the amount of the ambient light present.
10	Front Camera	Snapshot the view ahead the screen.
11	Rear Camera	Snapshot the view in front of the tablet.
12	Adjustable Kickstand	Flip out it to any angle and work comfortable at your desk, or hang it on automotive part.
13	Camera Flash	Produce a flash of artificial light.
14	Audio Speaker	Convert an electrical audio signal into a corresponding sound.
15	Charging Slot	Align it with the charging slot on the docking station to charge the tablet.

2.2 SmartLink C Device

The SmartLink C device features powerful functions and it can be applied in the following situations:

- 1). When as a VCI (Vehicle Communication Interface), it needs to work in conjunction with the **Diagnose** module of the tablet, which is used to obtain vehicle data, and then send it to the tablet for analysis via Bluetooth / data cable.
- 2). When as a SmartLink C (Customer) dongle, it does not communicate with the tablet, but it needs to work together with the **SmartLink** module of the tablet. The tablet is mainly used to issue remote diagnostic requests, and the SmartLink C dongle is networked to receive and execute commands from the remote SmartLink B (Business).

*Note: For detailed operations, please refer to Chapter 7.

- 3). When as a local or remote J2534 PassThru device, it can be used in conjunction with the PC installed with OEM diagnostic software.

*Note: For detailed operations, please refer to Chapter 10.

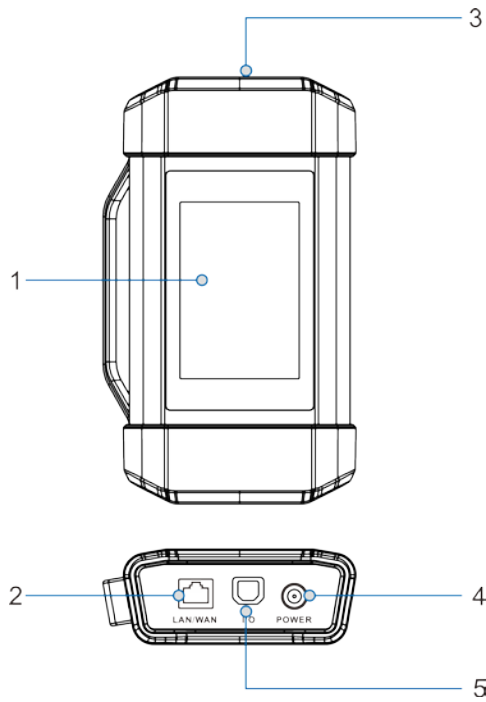

1	Touch Screen	
2	LAN/WAN Port	Connect the SmartLink C device to the Internet via the crossover cable.
3	OBD-16 Diagnostic Connector	Connect the SmartLink C device to the vehicle's DLC (Data Link Connector) port via the OBD II extension cable.
4	DC-IN Port	Currently disabled and for manufacturer use only. *Warning: The SmartLink C device obtains power through the vehicle's DLC, and it is prohibited to connect to an external DC power supply. No responsibility can be assumed for any damage or loss caused as a result of not strictly following the above method.
5	Data I/O Port	Connect the SmartLink C device to the PC via the data cable when as a J2534 PassThru device.

3 Initial Setup



3.1 Charging the Tablet

*Notes:



- Only use the included power adaptor to recharge the tablet. Use of any other adaptor will damage the tool. We assume no responsibility for damage or loss resulting from using other similar adaptors other than the specified one.
- Always charge on a non-flammable surface in a well-ventilated area.

To check the battery power level, press and hold the Power button about 3 seconds to turn on the tablet. Power level is indicated as a percentage in the upper right corner of the screen. If the power level drops below 10% while the tablet is on, a "Connect Charger" notification will appear on the screen.

1. Charging with the included 5V power adaptor

- 1) Connect one end of the power adaptor to charging port of the tablet, and the other end to the AC outlet.
- 2) The charging LED illuminates solid red and the charging symbol  will appear on the screen.
- 3) Once it illuminates solid green, it indicates that the battery is fully charged and the charging complete symbol  replaces the charging symbol. Disconnect the power adaptor from the AC outlet.

2. Charging with the docking station (optional)

- 1) Locate the charging slot on the bottom of the tablet and docking station.
- 2) Align the charging slots, and then dock the tablet into the station to ensure that it is firmly seated on the docking station.
- 3) Insert one end of the included power cord to the charging port of the docking station, then the other end into the AC outlet. The charging LED illuminates solid red while charging and the charging symbol  will appear on the screen.
- 4) Once it illuminates solid green, it indicates that the battery is fully charged and the charging complete symbol  replaces the charging symbol. Disconnect the power adaptor from the AC outlet.







3.2 Power On/Off

1. Press and hold the **POWER** button for about 3 seconds to turn on the tablet. The system starts initializing and then enters the home screen.
2. To turn the tablet off, press and hold the **POWER** button until an option menu appears. Tap **Power Off**.

3.3 Screen Layout

On-screen keys and status bar are as follows:



1	Tap  to visit the official website.
2	Tap  to capture the current screen and all captured screenshots are stored in the Screenshots folder.
3	 shows whether the VCI is connected properly or not.
4	Tap  to display a list of applications that are currently running or recently used. Tap certain application to open it. Swipe it upwards to close it.
5	Tap  to jump to the home screen.
6	Tap  to return to the previous screen or exit the application.

3.4 Adjusting Screen Brightness

The tablet is equipped with a built-in light intensity sensor. It can adjust the screen brightness according to the ambient

light intensity automatically. Alternatively, you can also adjust it manually.

1. On the home screen, tap **Other Modules -> Built-in apps -> Tablet Settings -> Display -> Brightness level**.
2. Drag the slider to adjust it.

Alternatively, user may also slide the **Automatically brightness** switch to ON, and the system will automatically adjust the screen brightness.

*Tips: Reducing the brightness of the screen is helpful to save the power of the tablet.

3.5 Changing Language

The tablet supports multiple languages. To change the language of the tablet, please do the following:

1. On the home screen, tap **Other Modules -> Built-in apps -> Tablet Settings -> Language & input -> Language**.
2. Tap the desired language from the list and the system will change to the chosen language.

3.6 Network Setup

The tablet has dual built-in Wi-Fi communication modules. One is used to communicate with the tablet, and the other allows the tablet to get online. Once you're online, you can register your tool, update diagnostic software & APK, browse the Internet and send email on your network.

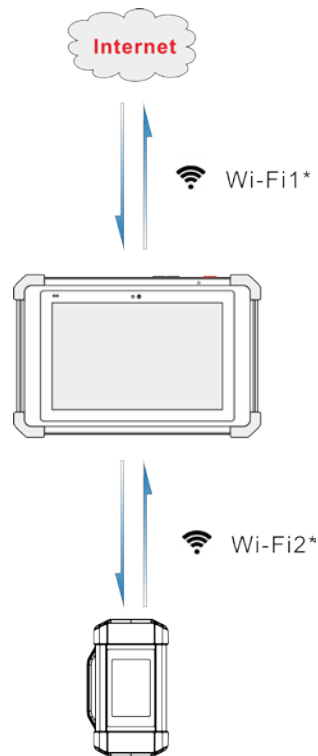

If the SmartLink C device is successfully activated, it will be automatically bound to the tablet. In this case it is not necessary for the user to manually configure it again.

*Note: Once WLAN is set as ON, the tablet will consume more power. While WLAN keeps unused, please turn it off to conserve battery power.

1. On the home screen, tap **Other Modules -> Built-in apps -> Tablet Settings -> WLAN**.
2. Tap or slide the Wi-Fi switch to ON, the tablet starts searching for all available wireless LANs.
3. Choose the desired Wi-Fi access point / network,
 - If the network you chose is open, you can connect directly;
 - If the selected network is encrypted, you have to enter the right security key (network password).

When this tool is in range, it will connect to the previously linked network automatically.

4 Getting Started

4.1 Register & Update

After the tablet is initialized, tap the **Login** button on the upper right corner of the screen, the following screen will appear:

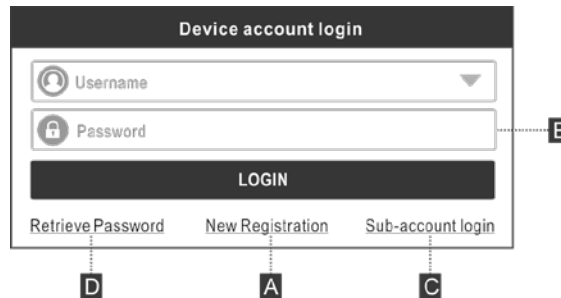

(If you are a new user, follow **A** to proceed.)

(If you have registered to be a member, go to **B** to login the system directly.)

(If you have bound a sub-account to this tool, go to **C** to login the system.)

(In case you forgot password, refer to **D** to reset a new password.)

A. If you are a new user, tap **New Registration** to enter sign-up page.

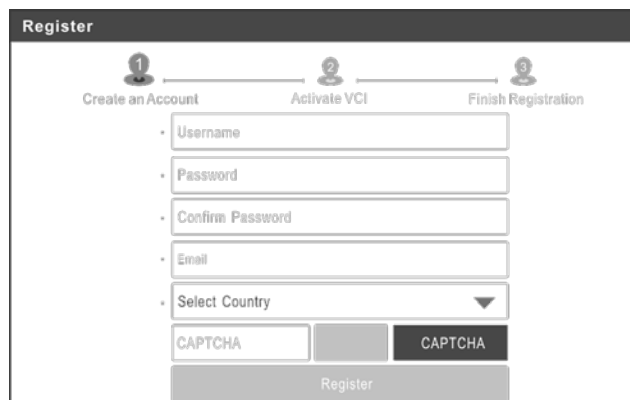

1. Create an App Account: Input the information to create a new account (all fields must be completed). When finished tap **Register**, the following screen will appear:

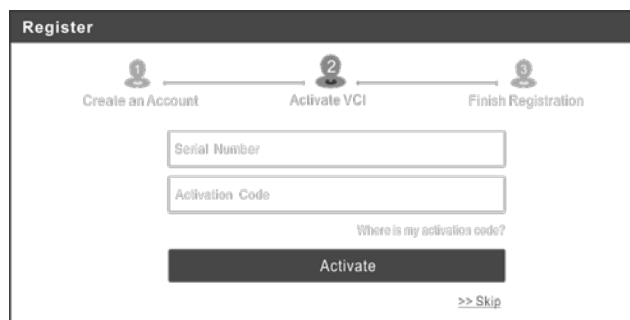

2. Activate VCI: Input the Product Serial Number and Activation Code, and tap **Activate** to go to the next step.

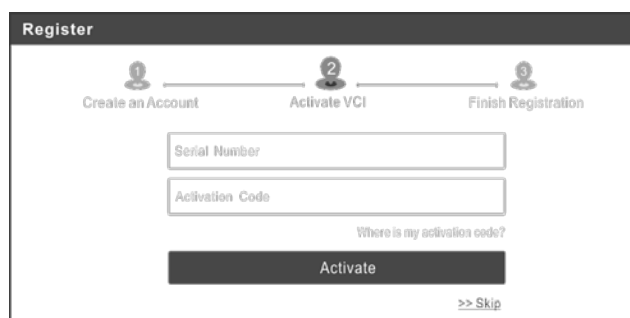

Input the Product Serial Number and Activation Code can be found in the supplied Password Envelope.

*Note: To exit and activate it later, tap **Skip**. In this case, you can activate the VCI by tapping **Other Modules -> User Info -> Activate VCI**.

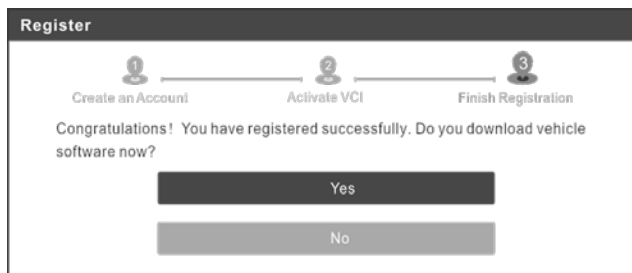

3. **Finish Registration:** Tap **Yes** to navigate to the download page and download the diagnostic software. Tap **No** to download and install it later.

On the download page, tap **Update** to start downloading. To pause downloading, tap **Stop**. Once download is complete, the system will install the software package automatically.

*Note: When downloading the diagnostic software or checking for updates, make sure the tablet has a strong Wi-Fi connection. It may take a long time to finish it, please be patient to wait.

B. If you have registered to be a member, input your name and password, and then tap the **Login** button to enter the main menu screen directly.

*Note: The tablet has an auto-save function. Once the username and password are correctly entered, the system will automatically store it. After initial setup, it is no longer necessary to input the account information manually to log in.

C. If you have created a sub-account or bound an existing account to the tool, tap **Sub-account login** to login. For more details on sub-accounts, refer to Chapter 9.3.11.

D. If you forgot the password, tap **Retrieve password** and then follow on-screen instructions to set a new password.

4.2 Home Screen

It mainly includes the following items:

Name	Description
IMMO	Enable you to perform the anti-theft key matching function, so that the immobilizer control system on the car identifies and authorizes remote control keys to normally use the car.
IMMO PROG	<ul style="list-style-type: none"> Read transponder data (including Mercedes Benz infrared smart key), and generate exclusive keys. Read/write on-board EEPROM chip data, and read/write MCU/ECU chip data.
Intelligent Diagnose	This module allows you to obtain vehicle data from the cloud server to perform quick test via reading VIN, which provides a perfect solution to various defects resulting from step-by-step menu selection. In addition, user can also check the historical repair records online through this module.
Local Diagnose	Diagnose a vehicle manually.
Remote Diagnose	This option aims to help repair shops or technicians launch instant messaging and remote diagnosis, making the repair job getting fixed faster.
SmartLink Diag.	<p>The SmartLink system is powerful remote diagnostics solution developed by LAUNCH.</p> <p>The system consists of SmartLink C dongle, SmartLink Service Platform and SmartLink B dongle.</p> <ul style="list-style-type: none"> <u>SmartLink C dongle</u>: For technicians seeking technical assistance and additional expertise on various vehicle issues. <u>SmartLink Service Platform</u>: For SmartLink C posting assistance request and

	<p>SmartLink B accepting order.</p> <ul style="list-style-type: none"> • SmartLink B dongle: For service provider or master technician providing technical assistance service.
TPMS	Configure this tool as a professional TPMS (Tire Pressure Monitoring System) service tool. It provides the ability to activate tire pressure information, program tire pressure sensor and perform the TPMS relearning functions etc.
ADAS	This function enables users to perform ADAS (Advanced Driver Assistance System) calibration operations. The ADAS calibration software is disabled by default. Before using this function, users must activate the ADAS function using the ADAS Activation Card.
Special function	Perform commonly used repair & maintenance services.
Diagnostic History	Provide a quick access to the tested vehicles and users can resume from the last operation, without starting from scratch.
Feedback	Feedback the recent 20 diagnostic logs to us for issue analysis.
Mall	Subscribe some extra software or service functions that are not included in the diagnostic tool online.
Software Update	Update vehicle diagnostic software and APK.
Info Center	Include product information and repair data etc.
Vehicle Coverage	View all the vehicle models that the tool covers.
Other Modules	Include user Info, toolbox (such as Oscilloscope, Sensor Simulator, Multimeter, Battery Tester and Videoscope etc) and some frequently used built-in apps.

4.3 Vehicle Menu Layout

After downloading the diagnostic software, you can go to **Local Diagnose** to check if all software are completely downloaded and installed.

Tap **Local Diagnose**, the following screen will appear:

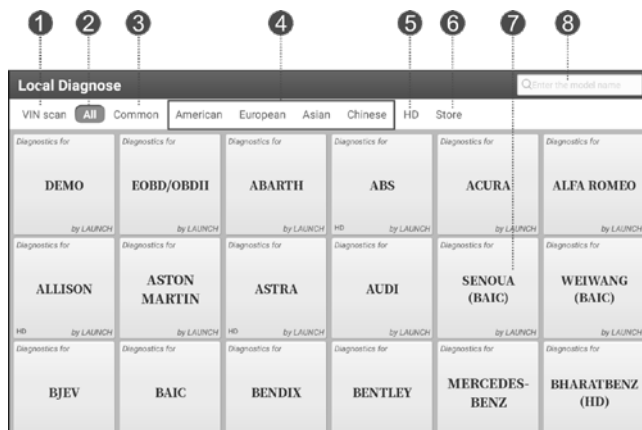

- 1 **VINScan** tab: Scan the Vehicle Identification Number (VIN) code of the vehicle. OBD VIN and INPUT VIN are included.

- 2 **All** tab: Display all the vehicle makes in the vehicle menu.

- 3 **Common** Tab: Display all frequently-used vehicle makes.

- 4 **Regional** buttons: Tap different buttons to switch to corresponding vehicles.

- 5 **HD** tab: it will only appear if the tablet supports the commercial vehicles. Tap it to select the

corresponding heavy-duty vehicle models.

6	Store tab: Enable you to renew your subscription and check the order status.
7	Vehicle software logo
8	Search bar: Allow you to quickly locate the desired vehicle model.

4.4 Diagnostics Toolbar

The diagnostics toolbar contains a number of buttons that enable various procedures. It is displayed at the top of the vehicle diagnostic screen throughout the whole diagnostic session. Refer to the table below for a brief description of the functions of the diagnostics toolbar buttons:



Name	Icon	Function
Home		Return to the home screen.
Print		Tap to print the selected screenshots out via external printer. The printer needs to be configured separately. For details on printer setting, refer to Chapter 10.11.3.
Exit		Exit the diagnostic application.

4.5 Connections

4.5.1 Preparation

- The vehicle ignition is turned on.
- The vehicle battery voltage range is 11-14 volts or 18-30 volts.
- The throttle is in the closed position.
- Find DLC location.

*For passenger cars, the DLC(Data Link Connector) is usually located 12 inches from the center of the instrument panel, under or around the driver’s side for most vehicles. For some vehicles with special designs, the DLC location may vary. Refer to the following figure for location.

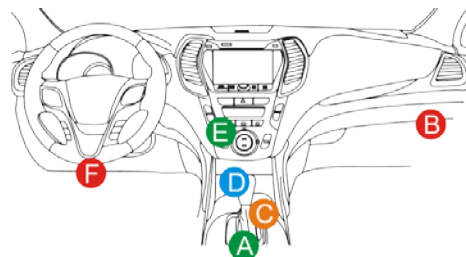

- A. Opel, Volkswagen, Audi
- B. Honda
- C. Volkswagen

D. Opel, Volkswagen, Citroen

E. Changan

F. Hyundai, Daewoo, Kia, Honda, Toyota, Nissan, Mitsubishi, Renault, Opel, BMW, Mercedes-Benz, Mazda, Volkswagen, Audi, GM, Chrysler, Peugeot, Regal, Beijing Jeep, Citroen and other most popular models

For commercial vehicles, the DLC is located in the driver's cab.

If the DLC cannot be found, refer to the vehicle's service manual for the location.

4.5.2 Vehicle connection

The method used to connect the VCI to a vehicle's DLC port depends on the vehicle's configuration as follows:

- A vehicle equipped with an OBD II management system supplies both communication and 12V power through a standardized DLC.
- A vehicle not equipped with an OBD II management system supplies communication through a DLC connection, and in some cases supplies 12V power through the cigarette lighter receptacle or a connection to the vehicle battery.

For OBD II vehicle:

Use the OBD II extension cable to connect the VCI and vehicle's DLC port.

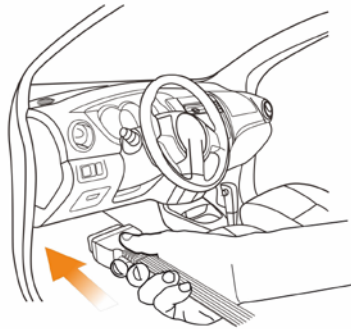

For non-OBDII vehicles, proceed as follows:

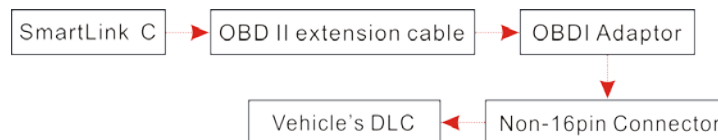

*Note: If the power supply on vehicle diagnostic socket is insufficient or the power pin is damaged, you can get power via either of the following ways:

- Via Battery clamps cable (optional): Connect one end of the battery clamps cable to the power jack of the OBD I adaptor box, and the other end to the vehicle's battery.
- Via Cigarette lighter cable (optional): Connect one end of the cigarette lighter cable to the power jack of the OBD I adaptor box, and the other end to the cigarette lighter receptacle.

5 Key Immobilizer & Immobilizer Programming

An immobilizer is an anti-theft mechanism that prevents a vehicle's engine from starting unless the correct ignition key or other device is present. Most new vehicles have an immobilizer as standard equipment. An important advantage of this system is that it doesn't require the car owner to activate it since it operates automatically. An immobilizer is considered as providing much more effective anti-theft protection than an audible alarm alone.

As an anti-theft device, an immobilizer disables one of the systems needed to start a car's engine, usually the ignition or the fuel supply. This is accomplished by radio frequency identification between a transponder in the ignition key and a device called a radio frequency reader in the steering column. When the key is placed in the ignition, the transponder sends a signal with a unique identification code to the reader, which relays it to a receiver in the vehicle's computer control module. If the code is correct, the computer allows the fuel supply and ignition systems to operate and start the car. If the code is incorrect or absent, the computer disables the system, and the car will be unable to start until the correct key is placed in the ignition.

5.1 Key Immobilizer (IMMO)

This function enables you to perform the anti-theft key matching function, so that the immobilizer control system on the car identifies and authorizes remote control keys to normally use the car.

It needs to be performed in the following cases:

When the ignition switch key, ignition switch, combined instrument panel, ECU, BCM, or remote control battery is replaced.

5.1.1 Vehicle connection

1). For most vehicles, just use the included OBD II extension cable to connect the VCI to the vehicle's DLC port.

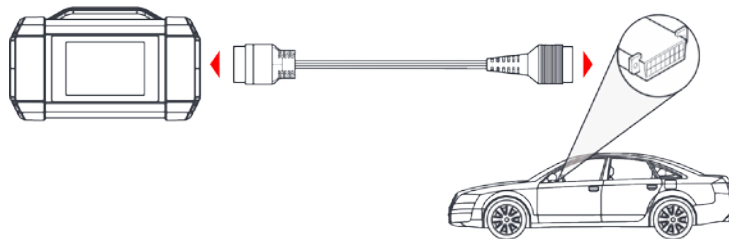

2). For other vehicles (including but not limited to the Mercedes Benz, Volkswagen, BMW and Porsche), the X-PROG 3/X-PROG is required.

A: OBD II extension cable

B: Main diagnostic cable included with the X-PROG 3/X-PROG immobilizer programmer

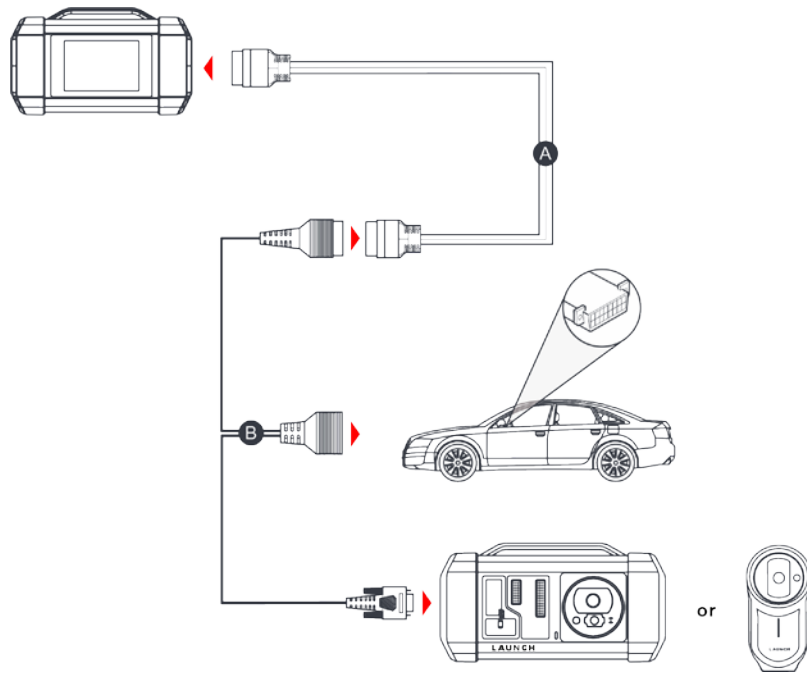

5.1.2 Immobilizer operations

Here we take the BMW for example to demonstrate how to perform the functions of key adding and all lost for BMW CAS4/CAS4+ Anti-theft system module.

- 1) Tap **IMMO** and select **BMW** to enter the software.

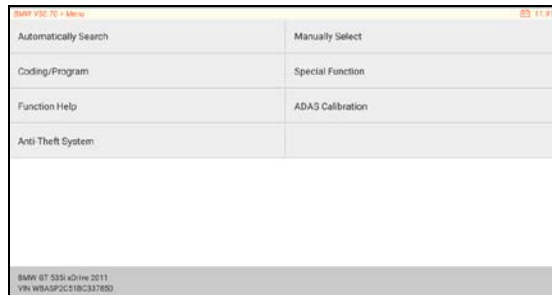

- 2) Tap **OK**.



- 3) Enter the Anti-Theft System, follow the illustration below to connect the VCI, vehicle and X-PROG3/X-PROG (*needs to purchased separately) to perform the next step.

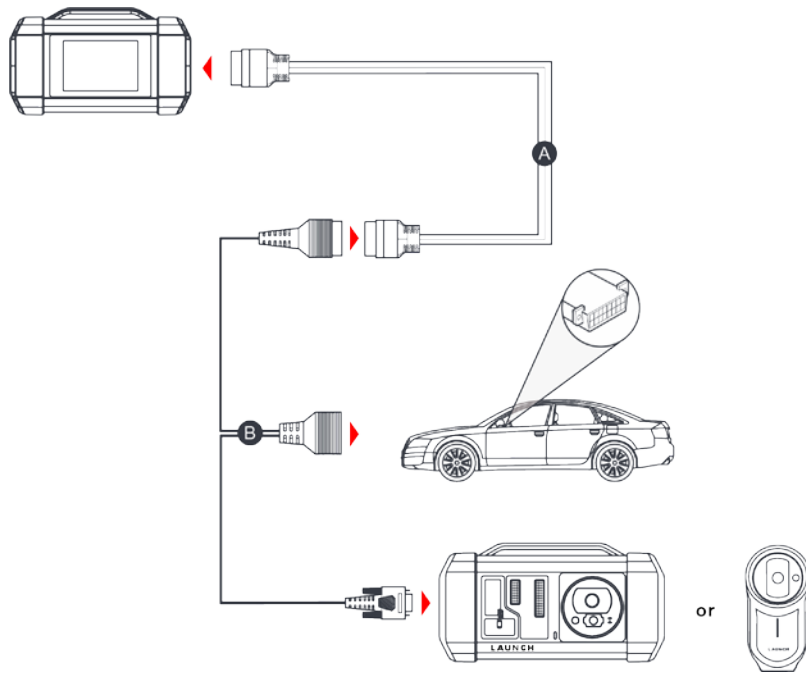

4) If you don't know the type of the Anti-Theft System, tap **Intelligent Mode** to enter.



5) Tap **CAS4/CAS4+ Anti-Theft System**, the following screen will appear:

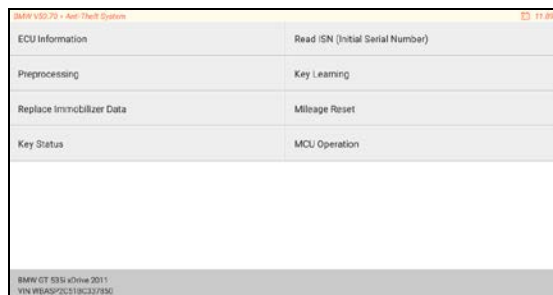

6) Tap **Preprocessing** to perform Read Anti-Theft data, Key Matching and more. If it has already been preprocessed, here you can perform the relevant functions. The ECU will be upgraded in this process, and files need to be downloaded online.

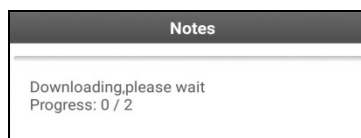

7) Make sure that vehicle power supply voltage is not lower than 13V and stable, and then tap **Yes** to start preprocessing.

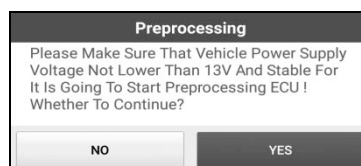

8) After preprocessing succeeded, tap **OK**.

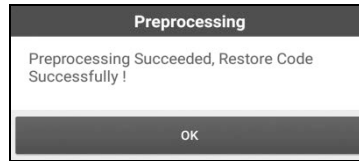

9) Return to the function menu and tap **Key Learning**.

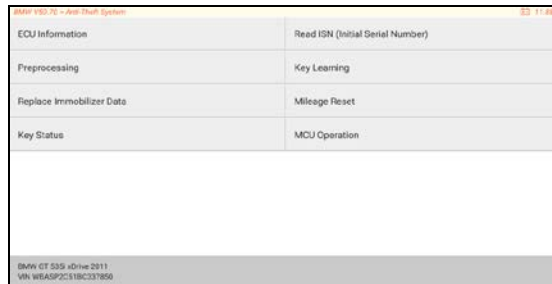

10) After the key information successfully read, select the unused key position and tap **Key Generated By Ignition Switch**.

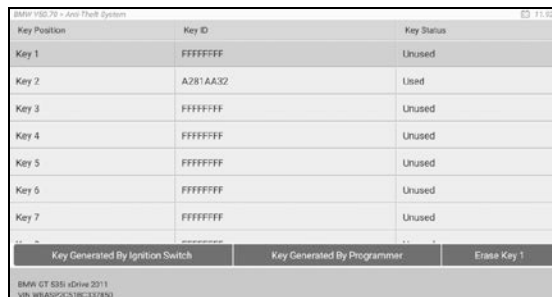

11) Read and display the password, and tap **OK**.

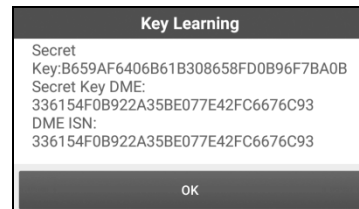

12) Place a new key close to vehicle coil, tap **OK**, and wait for the key to generate.

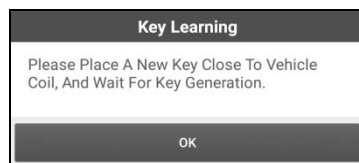

13) After the dealer key is successfully generated, please try to start the vehicle.

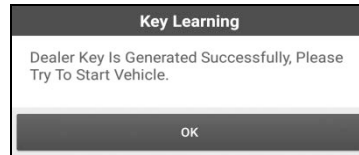

14) Now the key matching is finished and the new key is ready for use.



5.2 Immobilizer Programming (IMMO PROG)

The X-PROG 3 is required when performing this operation.

It has the following functions:

- 1). Read transponder data (including Mercedes Benz infrared smart key), and generate exclusive keys.
- 2). Read/write on-board EEPROM chip data, and read/write MCU/ECU chip data.

For more detailed operations, refer to the User Manual of the X-PROG 3.

6 Diagnosis

6.1 Intelligent Diagnose

Through simple Wi-Fi communication between the tablet and VCI, you can easily get the VIN (Vehicle Identification Number) information of the currently identified vehicle. Once the VIN is successfully identified, the system will retrieve it from the remote server and then guide you to vehicle information page without performing the step-by-step manual menu selection.

The vehicle information page lists all historical diagnostic records of the vehicle, which lets the technician have a total command of the vehicle faults. In addition, a quick dial to Local Diagnose and diagnostic function are also available on this page for reducing the roundabout time and increasing productivity.

*Notes:

- Before using this function, please make sure the VCI is properly connected to the vehicle's DLC port. For detailed connection, see Chapter 4.5.2.
- A stable network connection is required for this function.

Follow the steps below to proceed.

1. Tap **Intelligent Diagnose** to start pairing with the VCI.
2. After pairing is complete, the tablet starts reading the vehicle VIN.

A. If the VIN can be found from the remote server database, the following screen will appear:

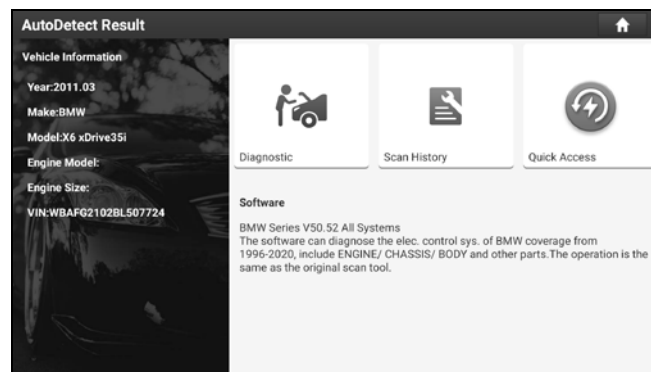

- Tap **Diagnostic** to start a new diagnostic session.
- To perform other functions, tap **Quick access** to directly go to the diagnostic function selection screen. Choose the desired one to start a new diagnostic session.
- Tap **Scan History** to view its historical repair record. If there are records available, it will be listed on the screen in sequence of date. If no records exist, the screen will show *No Record*.

Date	Number of diagnostic systems	Quantity of DTCs	Time	Action
2020 05/14	3	3	14:33:47	View Record
2020 03/12	0	0	10:17:02	View Record
	3	3	10:16:00	View Record
2020 03/10	4	10	16:39:54	View Record

Mazda 马自达2 2007
VIN LVSFDAMA37N000000

- Tap **View record** to view the details of the current diagnostic report.
- To perform other functions, tap **Quick access** to directly go to the diagnostic function selection screen. Choose the desired one to start a new diagnostic session.





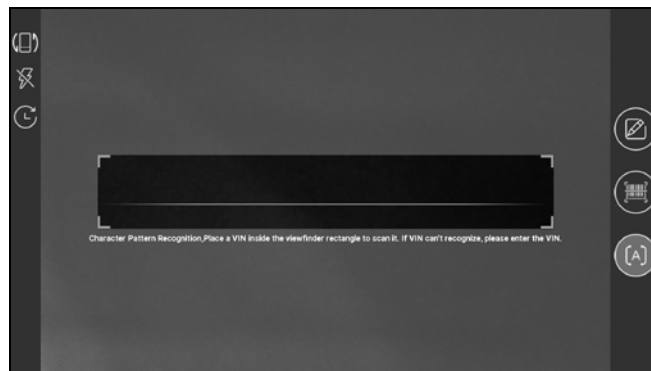

B. If the tablet failed to access the VIN information, the following screen will appear:



- Tap the input field to directly, tap **OK**. If the VIN exists on the remote server, the system will enter the diagnostic function selection screen.
- Tap  to launch the VIN recognition module.



Place the VIN inside the viewfinder rectangle to scan it. The most recognizable location for this number is in the top left corner on the vehicle's dashboard. Other locations include the driver's door or post, and the firewall under the hood.

- Tap  to switch the display mode of the screen.
- Tap  to turn the camera flash on.
- Tap  to choose it from the record list if the VIN of the vehicle has been scanned before.
- Tap  to input the VIN manually if the tablet has failed to identify the VIN of the vehicle.
- Tap  to scan the VIN barcode. If the VIN barcode cannot be recognized, please manually input the VIN.
- Tap  to scan the VIN character. If the VIN character cannot be recognized, please manually input the VIN.

*Note: In general, vehicle identification numbers are standardized - all contain 17 characters. VIN characters may be capital letters A through Z and numbers 1 through 0; however, the letters I, O and Q are never used in order to avoid mistakes of misreading. No signs or spaces are allowed in the VIN.

After scanning, the screen automatically displays the result.

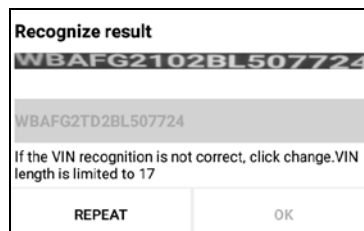

- If the VIN scanned is incorrect, tap the result field to modify it and then tap **OK**.
- To scan it again, tap **REPEAT**.

If the VIN exists on the remote server, the system will enter the diagnostic function selection screen.

6.2 Local Diagnose

Tap **Local Diagnose** to enter the vehicle selection page.

2 approaches are provided for you to access the vehicle diagnostic software. Choose any one of the following ways:

1. VINSCAN enables you to access it more quickly.

Tap **VINScan**, the following screen will appear:

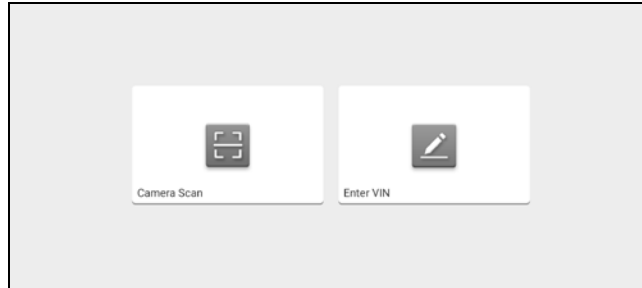

In this case, camera scan and enter VIN are available.

A. Camera Scan: In this mode, the VCI should be connected to the vehicle's DLC port first, and then a wireless communication should be established between the tablet and the VCI.

Tap **Camera Scan**, the following screen will appear:

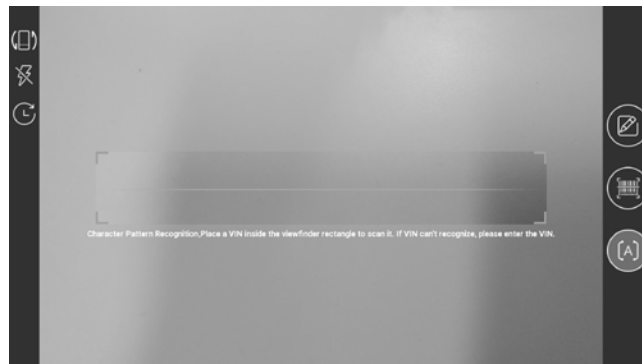

Place the VIN inside the viewfinder rectangle to scan it.

After scanning, the following screen will appear.

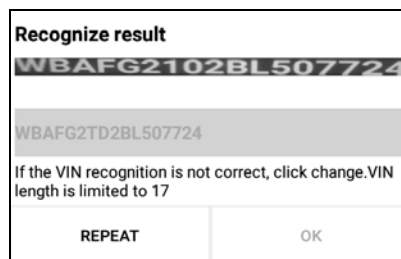

If the VIN scanned is incorrect, tap the result field to modify it and then tap **OK**. If the VIN exists on the remote server, the system will navigate to the diagnostic function selection screen directly.

Tap the desired option to perform the corresponding diagnostic function.

*Note: Before using this function, the corresponding diagnostic software and Auto search file need to be downloaded on your tool first while downloading the diagnostic software.

B. INPUT VIN: In this mode, you can input the vehicle VIN manually.

*Note: In general, vehicle identification numbers are standardized - all contain 17 characters. VIN characters may be capital letters A through Z and numbers 1 through 0; however, the letters I, O and Q are never used in order to avoid mistakes of misreading. No signs or spaces are allowed in the VIN.

Tap **Enter VIN**, the following screen will appear.



Input the VIN, and tap **OK**, the tablet will automatically identify the vehicle model and directly navigate to the diagnostic function selection menu.

2. Tap a corresponding diagnostic software logo, and then follow the on-screen instruction to access the diagnostic software.

Take Demo (V15.21) as an example to demonstrate how to diagnose a vehicle.

- 1). Select diagnostic software version: Tap the **DEMO** to go to Step 2.



On-screen Buttons:

Vehicle Coverage: Tap to view the vehicle models that the current diagnostic software covers.

What's new: Tap to view the optimized items and enhancements.

Introduction: Tap to check the software function list.

Note: Tap to read some precautions on using the current diagnostic software.

OK: Tap it to go to next step.

- 2). Select vehicle model (varies with different versions): Select the desired vehicle model. Here we take **Ford** for example to demonstrate how to diagnose a vehicle.

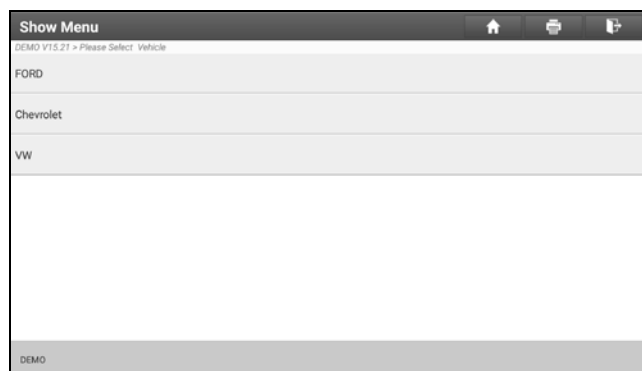

- 3). Read vehicle information: After reading the vehicle information, double check if the vehicle information is correct or not. If yes, tap **Yes** to continue.

- 4). Select test item: Select the desired test item to proceed.

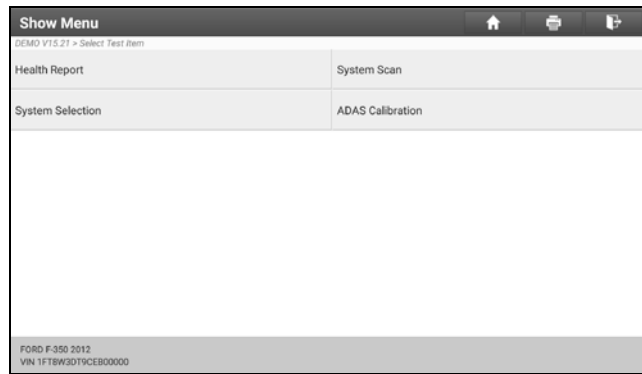

5). Turn the ignition key to ON: Set the ignition switch to on.

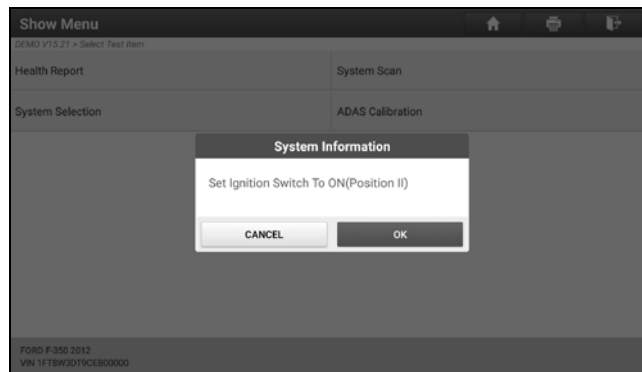

6.2.1 Health report (Quick Test)

This function varies from vehicle to vehicle. It enables you to quickly access all the electronic control units of the vehicle and generate a detailed report about vehicle health.

On the test item selection screen, tap **Health Report** and turn on the ignition switch, the system will start scanning the ECUs. Once the scanning process is complete, the following screen will appear:

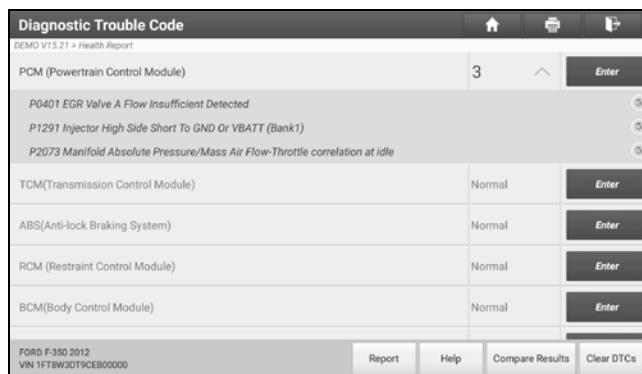

The tested system with fault code appears in red and the system with OK displays in green (normally).

*Note: Diagnostic Trouble Codes or Fault Codes can be used to identify which engine systems or components that are malfunctioning. Never replace a part based only on the DTC definition. Retrieving and using DTCs for troubleshooting vehicle operation is only one part of an overall diagnostic strategy. Follow testing procedures (in vehicle’s service manual), instructions and flowcharts to confirm the locations of the problem.

On-screen Buttons:

Enter: Tap to enter the diagnostic function selection screen.

 **(Search):** Highlight certain diagnostic trouble code and tap it to retrieve it in the search engine.

Report: Tap to save the diagnostic result as a health report.

*Note: Diagnostic report is classified into three categories: Pre-Repair report, Post-Repair report and Diagnostic Scan. No matter which type you saved the report as, the report type will be appended as a tag on the upper right corner of the diagnostic report for easier identification.

Tap ▼ to select the report type from the option list and input the required information, and then tap **OK**.

*Note: To facilitate the comparison of the pre-repair and post-repair reports and get accurate test result, please make sure you saved the right type of the diagnostic report.

To save the report as a common diagnostic report, select **Diagnostic Scan**.

*Note: For workshop information, tap the input box to enter it. Alternatively you can also set it in **User Info -> Settings -> Shop Information**.

Once you configured the information, it will be automatically generated every time you saved the diagnostic report. All vehicle and workshop information will be appended as tags on the diagnostic report.

To ignore the workshop information, tap **Skip** to go to the report details screen.

On the report details screen, tap **Save** to save it. All diagnostic reports are saved in **User Info -> My Report -> Health Report**.

Help: Tap to view the help information of the selected DTC item.

Compare Results: Tap to select the pre-repair report to compare. By comparison of the pre- and post- repair reports, you can easily identify which DTCs are cleared and which remain unfixed.

Compare Results		
DEMO V15.21 - Health Report		
DTC	Post	Pre
PCM (Powertrain Control Module)		
P0401 EGR Valve A Flow Insufficient Detected	Cleared	Found
P1291 Injector High Side Short To GND Or VBATT (Bank1)	Cleared	Found
P2073 Manifold Absolute Pressure/Mass Air Flow-Throttle correlation at idle	Cleared	Found

- **Post** indicates DTC status of post-repair.
- **Pre** indicates DTC status of pre-repair.

*Note: Before performing this function, please make sure that:

- You have saved a pre-repair report of the currently tested vehicle, and
- You have already made some repairs and service and cleared the DTCs after the pre-repair reported is generated. Otherwise, no differences exist between the pre- and post- repair reports.

Clear DTCs: Tap to clear the existing diagnostic trouble codes.

*Note: Clearing DTCs does not fix the problem(s) that caused the code(s) to be set. If proper repairs to correct the problem that caused the code(s) to be set are not made, the code(s) will appear again and the check engine light will illuminate as soon as the problem that cause the DTC to set manifests itself.

6.2.2 System scan

This option allows you to quickly scan which systems are installed on the vehicle.

On the test item selection screen, tap **System Scan**, the system start scanning the systems. Once the scanning process is complete, the following screen will appear.

Select Test Item	
DEMO V15.21 - System Scan	
System Name	Result
PCM (Powertrain Control Module)	Equipped
TCM(Transmission Control Module)	Equipped
ABS(Anti-lock Braking System)	Equipped
RCM (Restraint Control Module)	Equipped
BCM(Body Control Module)	Equipped
IMMO(Immobilizer)	Equipped
APIM (Accessory Protocol Interface Module)	Equipped
PAM (Parking Assist Module)	Equipped

FORD F-350 2012
VIN 1FTFW30T9CEB00006

Tap the desired system to go to the diagnostic function selection screen. For detailed operations on diagnostic function, please refer to Chapter 6.2.3.

6.2.3 System selection

This option allows you to manually select the test system and function step by step.

On the test item selection screen, tap **System Selection**, the screen displays as follows:

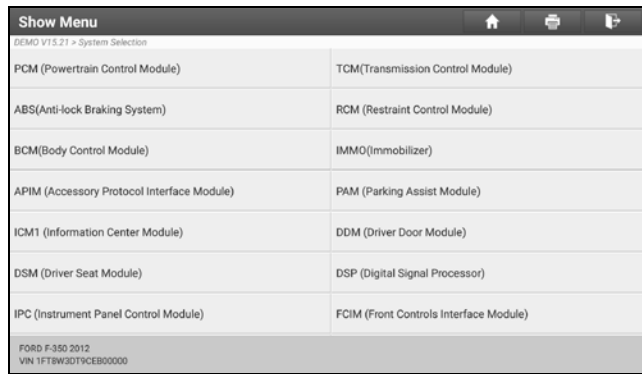

Swipe the screen from the bottom to view the vehicle system on the next page.

Tap the target system (take **ECM** for example) to navigate to the diagnostic function selection screen.

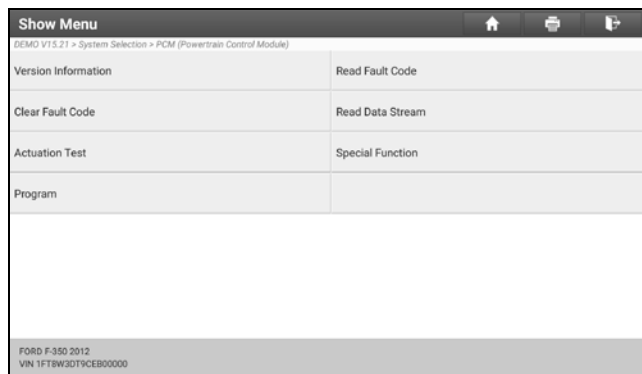

*Note: Different vehicle has different diagnostic menus.

A. Version Information

This function is used to read the version information of system mode, vehicle VIN, software and ECU.

B. Read Fault Code

This function displays the detailed information of DTC records retrieved from the vehicle’s control system.

*Note: Retrieving and using DTCs for troubleshooting vehicle operation is only one part of an overall diagnostic strategy. Never replace a part based only on the DTC definition. Each DTC has a set of testing procedures, instructions and flow charts that must be followed to confirm the location of the problem. This information can be found in the vehicle’s service manual.

On the diagnostic function selection screen, tap **Read Fault Code**, the screen will display the diagnostic result.

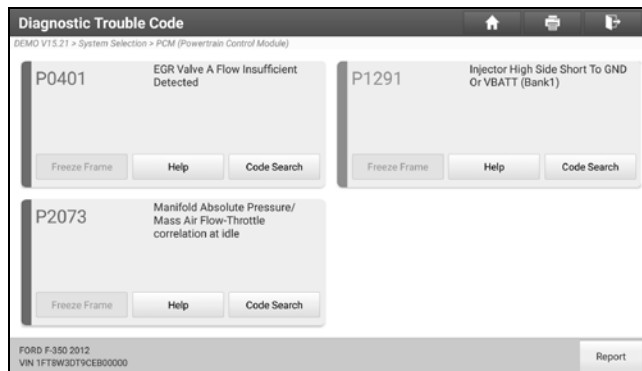

On-screen Buttons:

Freeze Frame: When an emission-related fault occurs, certain vehicle conditions are recorded by the on-board computer. This information is referred to as freeze frame data. Freeze frame data includes a snapshot of critical parameter values at the time the DTC is set.

Help: Tap to view the help information.

Code Search: Tap to search for more information about the current DTC online.

Report: Tap to save the current data in text format. All reports are saved in **User Info -> My Report -> Health**

Reports. For details on report operations, please refer to Chapter 10.1 **My Report**.

C. Clear Fault Code

This function enables you to erase the codes from the vehicle after reading the retrieved codes from the vehicle and certain repairs have been carried out. Before performing this function, make sure the vehicle's ignition key is in the ON position with the engine off.

Clearing DTCs does not fix the problem(s) that caused the code(s) to be set. If proper repairs to correct the problem that caused the code(s) to be set are not made, the code(s) will appear again and the check engine light will illuminate as soon as the problem that cause the DTC to set manifests itself.

On the diagnostic function selection screen, tap **Clear Fault Code**, a confirmation dialog box will appear.

Tap **YES**, the system will automatically delete the currently existing trouble code.

*Note: After clearing, you should retrieve trouble codes once more or turn ignition on and retrieve codes again. If there are still some trouble codes in the system, please troubleshoot the code using a factory diagnosis guide, then clear the code and recheck.

D. Read Data Stream

This option lets you view and capture (record) real-time Live Data. This data including current operating status for parameters and/or sensor information can provide insight on overall vehicle performance. It can also be used to guide vehicle repair.

*Notes:

- If you must drive the vehicle in order to perform a troubleshooting procedure, ALWAYS have a second person help you. Trying to drive and operate the diagnostic tool at the same time is dangerous, and could cause a serious traffic accident.
- The real time (Live Data) vehicle operating information (values/status) that the on-board computer supplies to the tool for each sensor, actuator, switch, etc. is called Parameter Identification Data (PID).

On the diagnostic function selection screen, tap **Read Data Stream**, the following screen will appear.

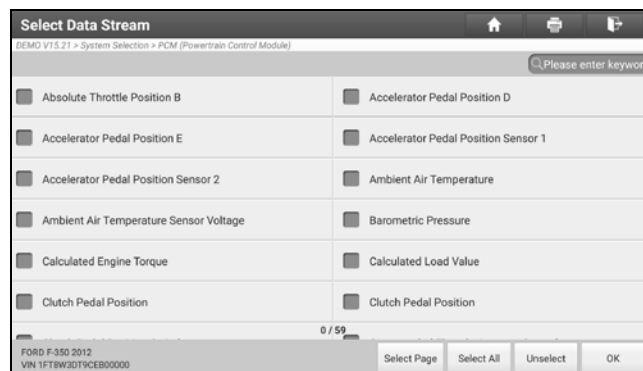

On-screen Buttons:

Select Page: Tap to select all items of the current page.

Select All: Tap to select all items. To select certain data stream item, just check the box before the item name.

Unselect: Tap to deselect all data stream items.

OK: Tap to confirm and jump to the next step.

After selecting the desired items, tap **OK** to enter the data stream reading page.

Name	Value	Standard Range	English	Metric
Absolute Throttle Position B	14.12	0 - 100	%	
Accelerator Pedal Position D	7.06	0 - 100	%	
Accelerator Pedal Position E	24.71	0 - 100	%	
Accelerator Pedal Position Sensor 1	1.04	0 - 5	V	
Accelerator Pedal Position Sensor 2	0.53	0 - 5	V	
Ambient Air Temperature	21 (1 / 2)	-40 - 215	degree C	

FORD F-350 2012
VIN 1FT8W3D79CEB00000

Compare Sample Save Sample Graph Report Record Help

***Notes:**

1. If the value of the data stream item is out of the range of the standard (reference) value, the whole line will display in red. If it complies with the reference value, it displays in blue (normal mode).
2. The indicator 1/X shown on the bottom of the screen stands for the current page/total page number. Swipe the screen from the right/left to advance/return to the next/previous page.

There are 3 types of display modes available for data viewing, allowing you to view various types of parameters in the most suitable way.

- ✓ **Value** – This is the default mode which displays the parameters in texts and shows in list format.
- ✓ **Graph** – Displays the parameters in waveform graphs.
- ✓ **Combine** – This option is mostly used in graph merge status for data comparison. In this case, different items are marked in different colors.

On-screen Buttons:

Graph(Single): Tap to view the parameter in waveform graph.

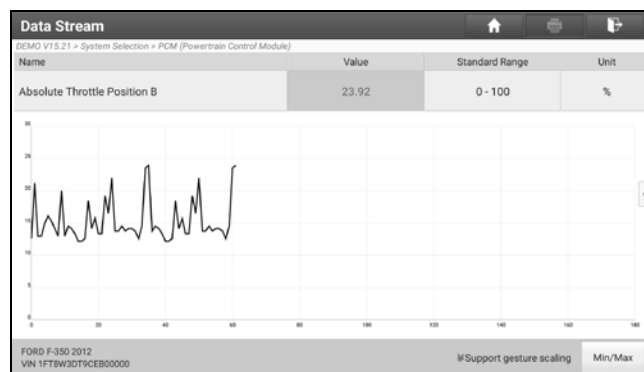

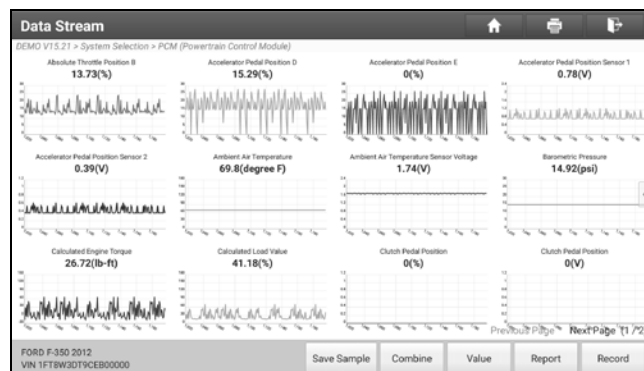

- **Min/Max:** Tap to define the maximum / minimum value. Once the value goes beyond the specified value, the system will alarm.

Graph: Tap to view the parameters in waveform graphs.

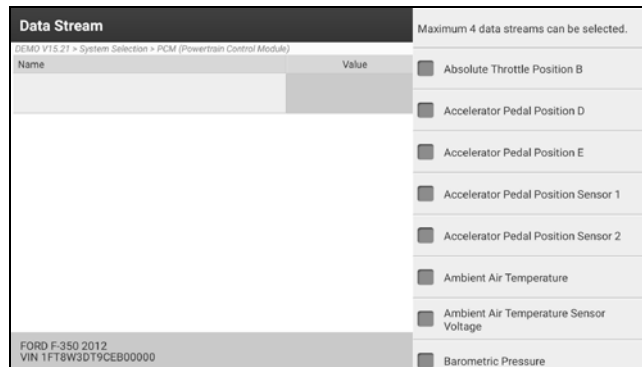

- **Combine:** This option is mostly used in graph merge status for data comparison. In this case, different items are marked in different colors (maximum 4 items can be displayed on the same screen simultaneously). If the graph is more than one page, swipe the screen from the left to jump to the next page.



- **Value:** Switches the current graph display mode to the Value display mode.
- **Customize:** Tap , a pull-down list of the data stream items appears on the screen. Select / deselect the desired items, and then screen will display / remove the waveforms corresponding to these items immediately.

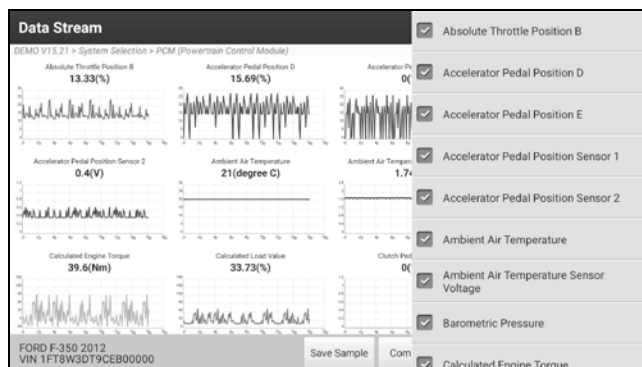

Compare Sample: Tap to select the sample DS file.

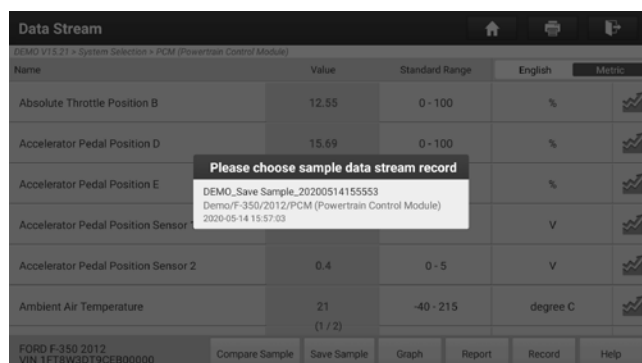

All the values you customized and saved in process of DS sampling will be imported into the **Standard Range** (See below) column for your comparison.

*Note: Before executing this function, you have to sample the values of data stream items and save it as a sample Data Stream file.

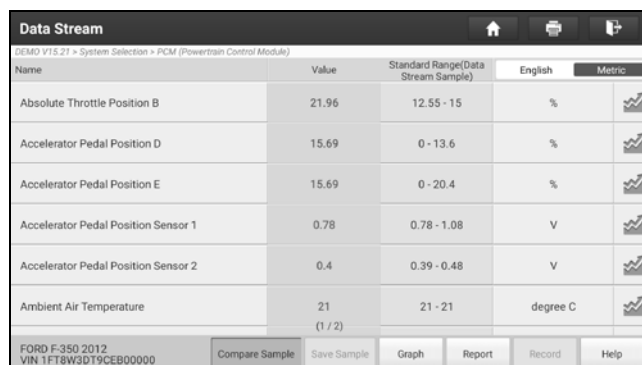

Report: Tap to save the current data in text format. All reports are saved in **User Info -> My Report -> Health Reports**. For details on report operations, please refer to Chapter 10.1.

Record: Tap to start recording diagnostic data. Recorded live data can serve as valuable information to help you in troubleshooting of vehicle problems.



Tap to end recording and save it. The saved file follows the naming rule: It begins with vehicle type, and then the product S/N and ends with record starting time (To differentiate between files, please configure the accurate system time).

All diagnostic records can be replayed from **User Info -> My Report -> Recorded Data**.

Save Sample: This item enables you to customize the standard range of live data stream items and save it as DS sample file. Each time you run the data stream items, you can call out the corresponding sample data to overwrite the current standard range.

Tap it to start recording the sample data (*Note: Only data stream items with measurement units will be recorded), the following screen will appear:

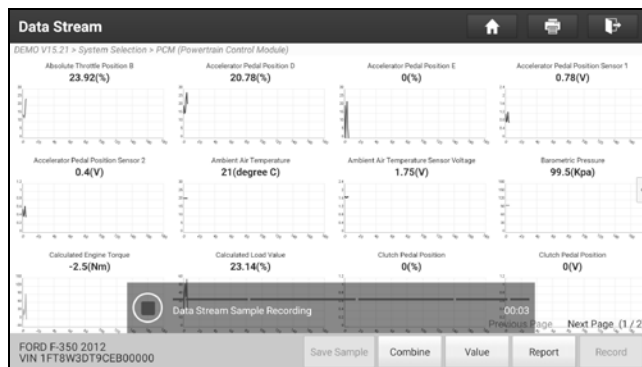

Once the recording process is complete, tap to stop it and navigate to the data revision screen.

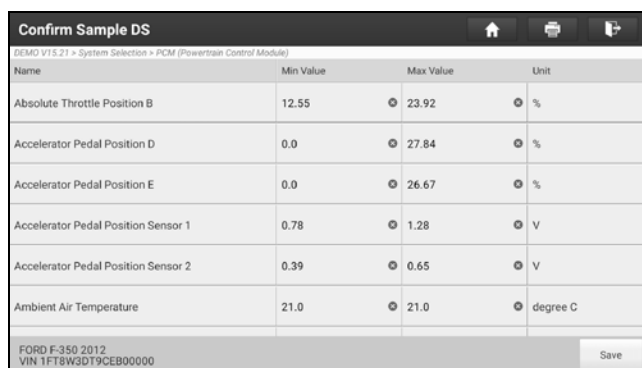

Tap the Min./Max. value to change it. After modifying all desired items, tap **Save** to save it as a sample DS file. All DS files are stored in **User Info -> Data Stream Sample**.

E. Actuation Test

This option is used to access vehicle-specific subsystem and component tests. Available test vary by vehicle manufacturer, year, and model.

During the actuation test, the display tablet outputs commands to the ECU in order to drive the actuators, and then determines the integrity of the system or parts by reading the ECU data, or by monitoring the operation of the actuators, such as switching a injector between two operating states.

On the diagnostic function selection screen, tap **Actuation Test**, the system will display as follows:

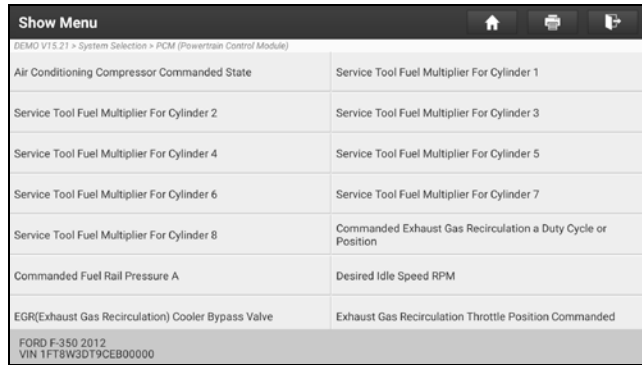

Simply follow the on-screen instructions and make appropriate selections to complete the test.



Each time when an operation is successfully executed, “Completed” displays.

6.2.4 ADAS calibration

This function enables users to perform ADAS calibration operations. The ADAS calibration software is disabled by default. Before using this function, users must activate it using the ADAS Activation Card.

6.3 Remote Diagnose

6.3.1 X-431 Remote Diagnose

This option aims to help repair shops or technicians launch instant messaging and remote diagnosis, making the repair job getting fixed faster.

Tap **Remote Diagnose** on the home screen.

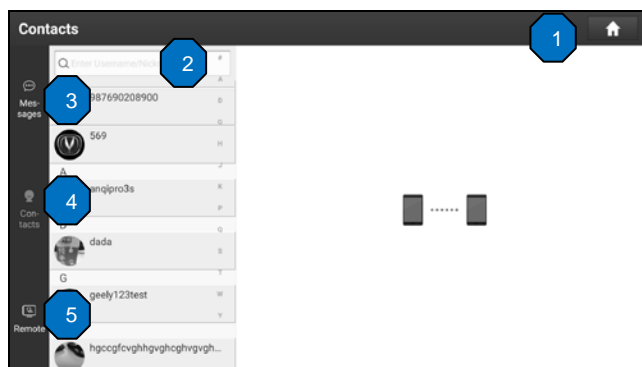

1	Home button	Tap it to navigate to the home screen.
2	Search bar	Directly input the registered username of the tool to start searching, and then tap the desired one to add it into your friend list.
3	Messages tab	Once an incoming message reaches, a red dot will appear on the upper right

		corner of the tab.
4	Contacts tab	Tap to enter the friend list.
5	Remote	Tap to slide the switch to ON, the tool will become accessible on the web client. In this case, inform the technician of your product S/N, and he/she will control your device remotely.

1. How to add friends?

Tap **Contact** to enter the contact page. By default it appears blank.

In the search bar, input the partner’s username and tap **Search** button next to the search bar to starts searching from Launch’s business database.

The partner must be the users who have registered their Launch-specific diagnostic tools. They may be the following:

- Workshop
- Technician
- golo users

Once the result matches the keyword, the following screen will appear:

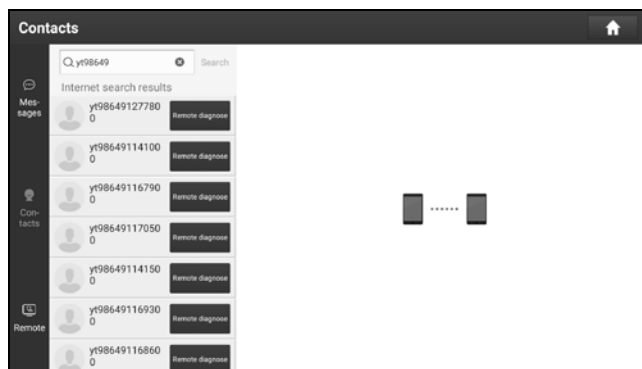

Tap **Remote Diagnose** to launch remote diagnostics directly or follow the steps below to add the partner into the Contacts list.

Tap the desired name from the list, the following screen will appear:

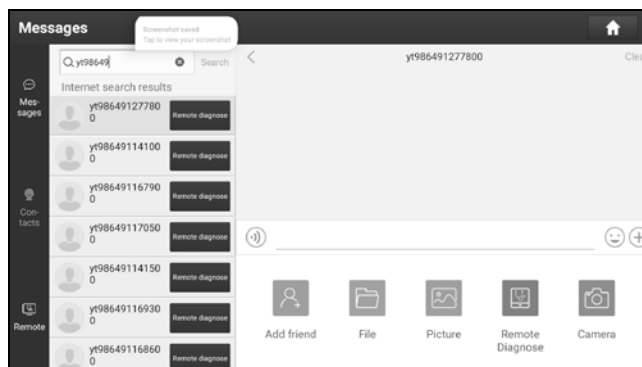

Tap **Add friend**, a dialog box pops up:

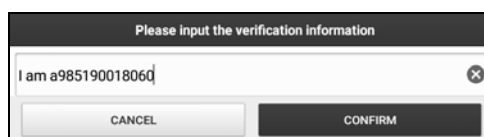

Tap **CONFIRM** to send your request.

Once the partner receives the request, a beep will sound. Tap the **Message** tab:

- Once the partner agreed your request, he/she will automatically be listed in the **Contacts** tab.
- If a technician sent you a friend request, tap **Agree** and his/her name will appear in the friend (**Contacts**) list. Or tap

Ignore to ignore this request.

2. Instant messaging (I/M) operations

*Note: The I/M (Instant Messaging) function is open to all users who had Launch’s diagnostic tool equipped with this module.

After adding your friends, tap the desired one’s photo to the following figure:

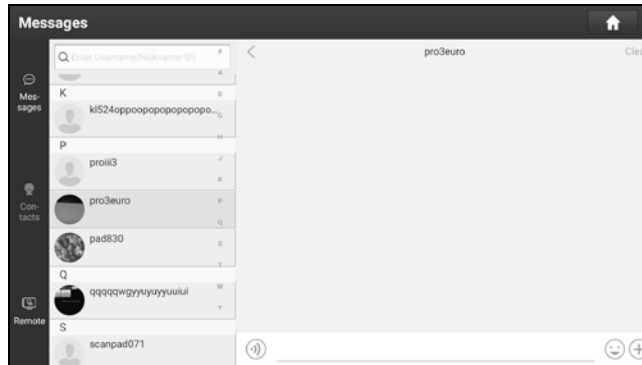

Tap the input field and use the on-screen keyboard to enter the text message, and then tap **Send** to send it.

Tap to send the voice message.

Tap to send the emoji.

Tap to call out more function options.

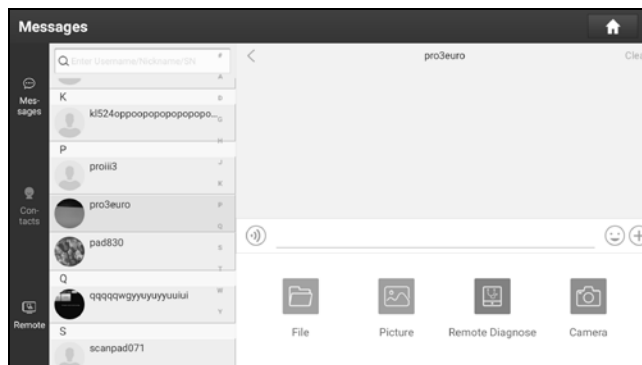

File: Choose diagnostic reports or local files to send.

Picture: Choose screenshots or pictures to send.

Remote Diagnose: To start a remote diagnostic session. For details, refer to Chapter 5.3.4.

Camera: Open camera to take pictures.

Tap **Clear** to delete all the partner’s dialog logs.

3. Launch remote diagnosis (Device-To-Device)

The tool is allowed to initiate remote diagnosis with other diagnostic tools (including but not limited to the X-431 IMMO PAD of Launch family, which are equipped with this module.



* Note: Before performing this operation, please make sure the following no matter which side sends the remote request:

- Turn on the vehicle power supply.
- Throttle should be in a closed position.
- The tool should be properly connected to the vehicle’s DLC and a successful communication is required.

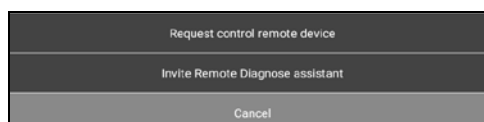
On the function option selection screen, tap **Remote Diagnostic**, the following screen will appear:

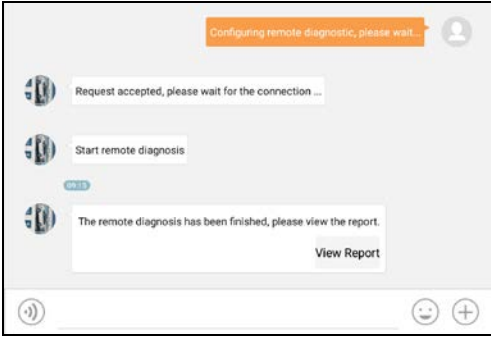

These options are defined as follows:

Actions	Results
<p>Request control remote device</p>	<p>Request to control the partner’s device remotely to help him diagnose the vehicle.</p> <p>*Notes:</p> <ul style="list-style-type: none"> • Remote diagnosis has the same diagnostic steps as manual diagnosis. • In process of remote diagnosis, tap the  button to send a voice message. • Once vehicle diagnosis is complete, a report will be created. Input your comments on this report, and then tap Send Report to send it to the partner. <div data-bbox="794 477 1185 909" style="border: 1px solid black; padding: 10px; text-align: center;"> <p>Tap “Request control remote device”</p> <p>↓</p> <p>Wait for partner’s confirmation</p> <p>↓</p> <p>Start connecting after request confirmed</p> <p>↓</p> <p>Start Diagnosis</p> <p>↓</p> <p>Generate diagnostic report</p> </div>
<p>Invite remote diagnostic assistant</p>	<p>If you need support, just use this option to invite a technician to perform a remote control on your tool.</p> <p>*Notes:</p> <ul style="list-style-type: none"> • Remote diagnosis has the same diagnostic steps as manual diagnosis. • In process of remote diagnosis, tap the  button to send voice message. • Once you received the report from the partner, tap View Report to view its details. All diagnostic reports are saved in User Info -> My Reports -> Remote Reports. <div data-bbox="743 1227 1236 1563" style="border: 1px solid black; padding: 10px;">  </div>

	<pre> graph TD A[Tap "Invite remote diagnostic assistant"] --> B[Choose the desired diagnostic software] B --> C[Wait for partner's confirmation] C --> D[Start connecting after request confirmed] D --> E[Start Diagnosis] E --> F[Generate diagnostic report] </pre>
<p>Cancel</p>	<p>To cancel this operation.</p>

4. Launch remote diagnosis (Device-To-PC)

Except that the remote diagnosis can be done between different Launch's diagnostic tools that come loaded with the module, user also can ask for remote control from PC client technician.

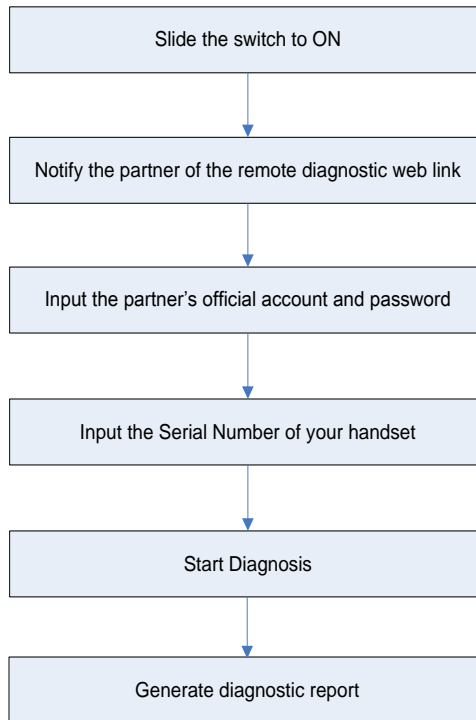

Tap the **Remote** tab, the following screen will appear:

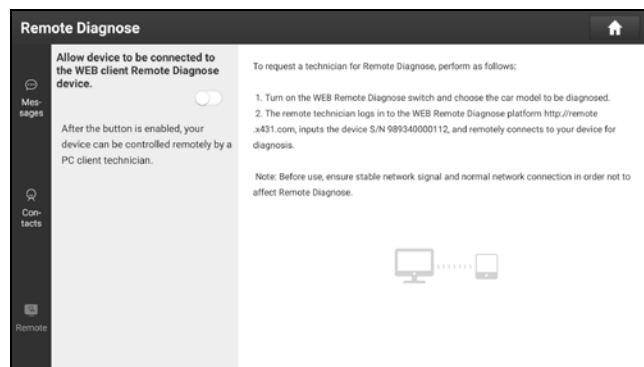

1. Slide the switch **Allow device to be connected to the WEB client remote diagnostic device** to ON so that the partner can find and connect to this device while using the PC.
2. Notify the partner of the PC client website <http://remote.x431.com>. When the partner accesses the link, the following screen will appear:

*Note: Before processing remote diagnosis, please make sure the tool is properly connected to the vehicle.

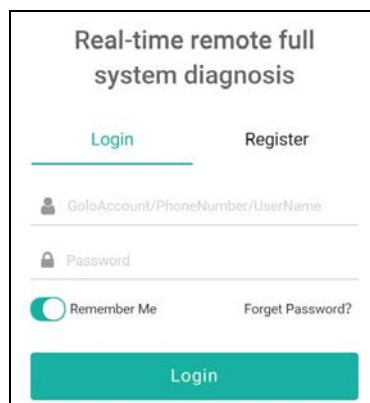

3. Tell the partner to input his own official technician account and password, and then tap **Login** to navigate to the following figure.

Remote diagnosis

Serial Number
Locate the car to be diagnosed according to golo/AIT serial number

License Plate Number
Locate the car to be diagnosed according to the car owner's license plate number

Phone Number
Locate the car to be diagnosed according to the car owner's phone number

97229000223

Start remote diagnosis

Tips: Before starting remote diagnosis, confirm the car owner's car information and condition

4. Tell the partner to check the box **Serial number** and enter the Serial Number provided by you, and then tap **Start remote diagnosis** to control your device remotely.

In process of remote diagnosis, please note the following things:

- 1) You are not suggested to execute any actions.
- 2) The partner is not allowed to save any diagnostic reports or records on your tool.

The operations in remote diagnosis are same as those in local diagnose. Once the session is complete, a remote diagnostic report will be automatically generated.

6.3.2 SmartLink Diag.

SmartLink is a newly developed powerful service system dedicated to remote vehicle diagnosis and service. In the SmartLink ecology system, if a technician (SmartLink C) does not have time to puzzle through a touch vehicle problem, he can seek a trusted second opinion or additional expertise on various vehicle issues from remote master technicians or repair shops (SmartLink B). SmartLink B enables the shop owner to greatly increase customer's retention and boost shop revenue by providing the professional technical assistance service.

It mainly consists of the following parts:

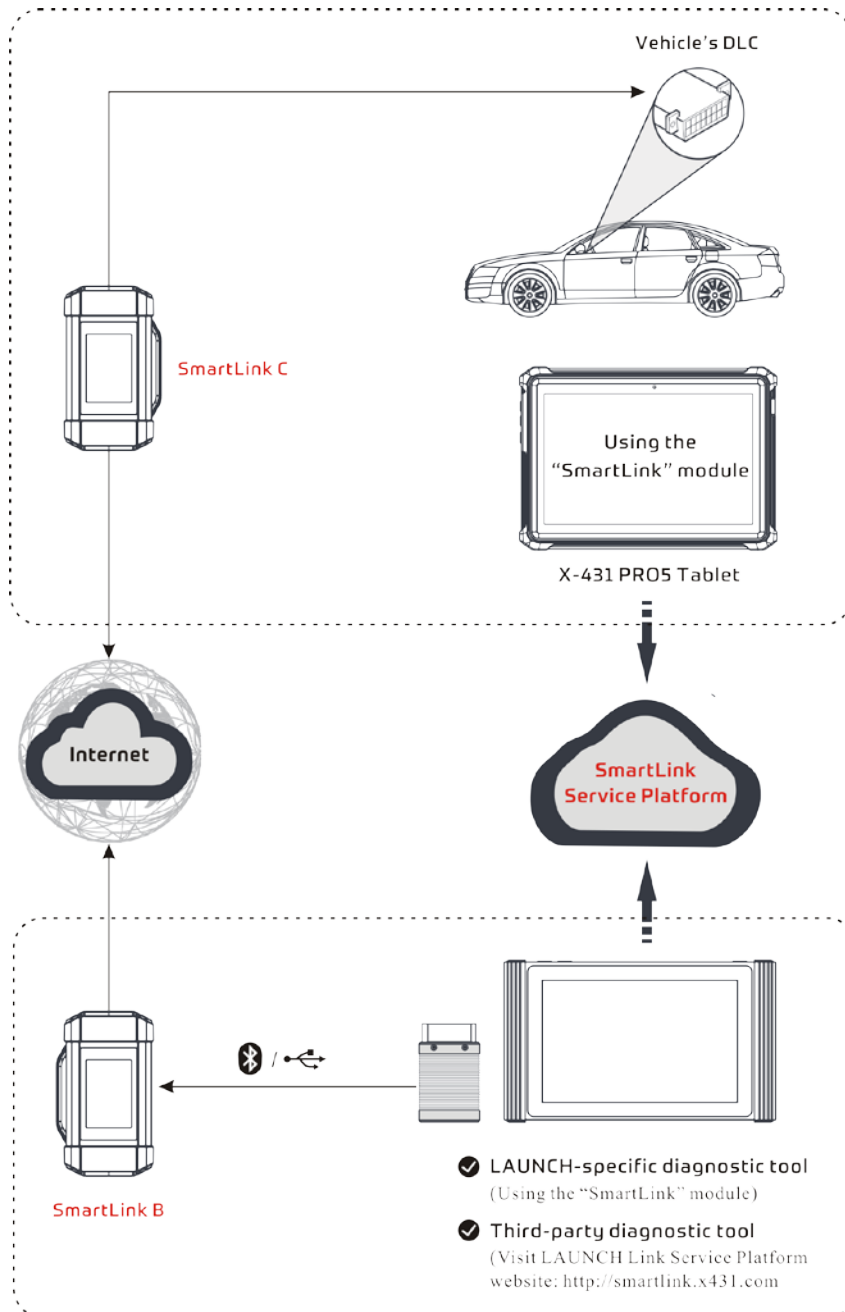

- **SmartLink Service Platform** – It can be accessed from the **SmartLink** module of the tablet. There are two modules available on the link service platform: **I'd like a remote assistance** (for SmartLink C) and **I am a remote technician** (for SmartLink B).
- **SmartLink C (Customer) - SmartLink Service Subscriber.** In the SmartLink system, the SmartLink A has an **I'd like a remote assistance** module on the SmartLink Service Platform for submitting remote repair orders plus a SmartLink A dongle for accessing vehicle data. It supports remote diagnostic services for vehicles that meet CAN / CAN FD / J2534 vehicle diagnostic standards.

1). Launch Service Link Platform: Binds SmartLink C dongles and submits remote repair orders.

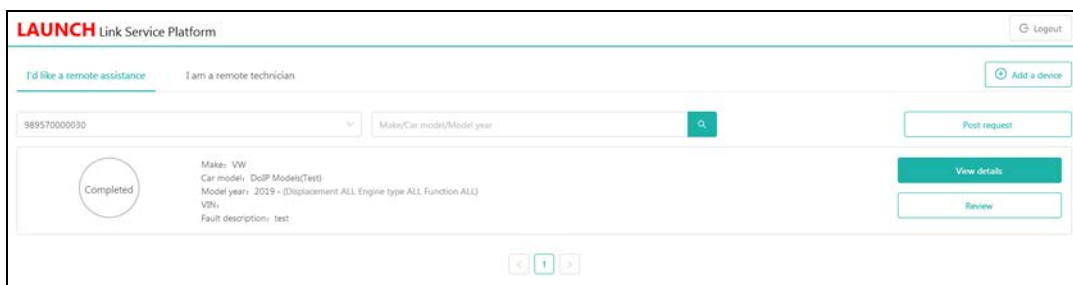

2). SmartLink C Dongle: Connects to the vehicle's DLC port for collecting the vehicle data and sends it to the remote SmartLink B.

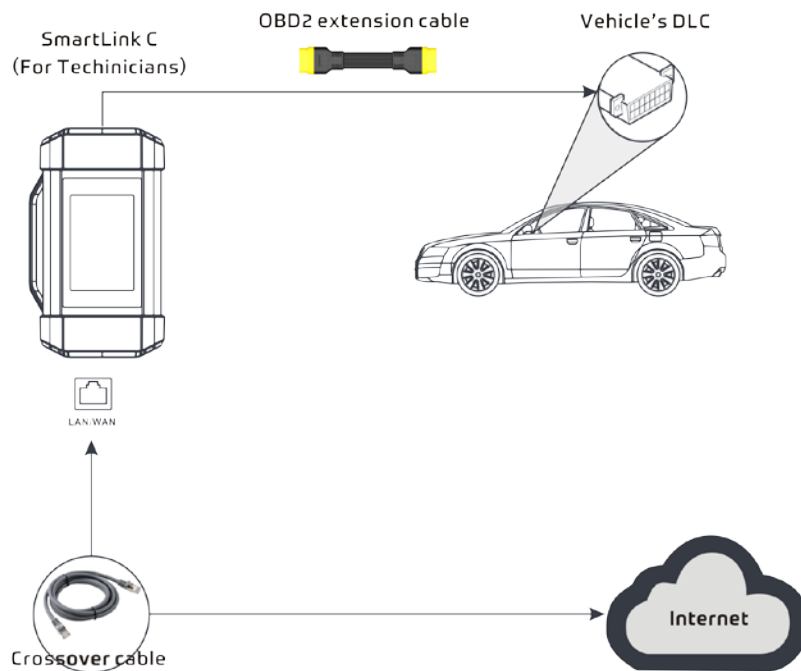

- **SmartLink B (Business) - SmartLink Service Provider.** In the SmartLink system, the SmartLink B has an **I am a remote technician** module on the SmartLink Service Platform for accepting the orders from SmartLink C plus a SmartLink B dongle for providing hardware support.

1). Launch Service Link Platform: Binds SmartLink B dongles and accepts orders from SmartLink C.

- If the SmartLink B dongle works with the LAUNCH-specific diagnostic tool equipped with SmartLink module, tap **SmartLink** to add the SmartLink B device and accepts orders on the diagnostic tool.
- If the SmartLink B dongle works with the third-party diagnostic tool, open the browser and visit SmartLink Service Platform website <http://smartlink.x431.com> (web client) to add the SmartLink B device and accepts orders in the browser.

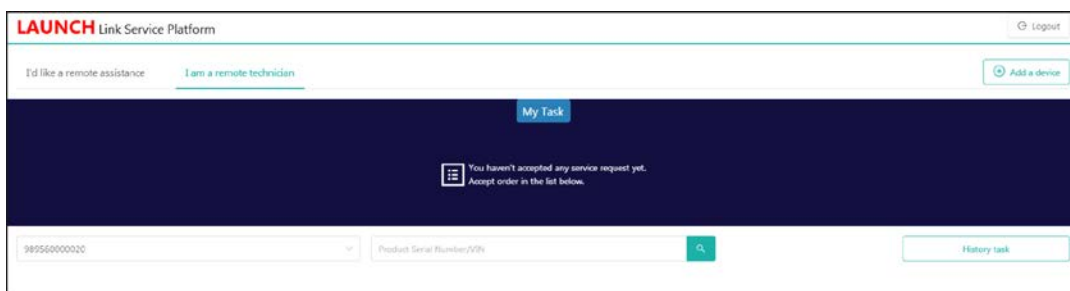

2). SmartLink B Dongle: After accepting the orders, it can work with the compatible diagnostic tool to perform diagnosis of the vehicle connected to the SmartLink C dongle.

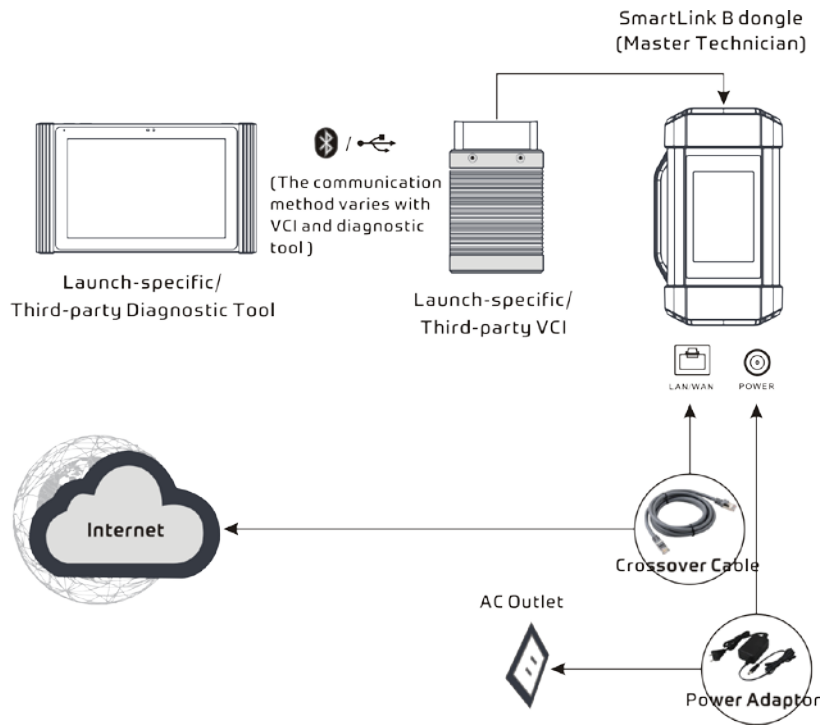

1. Posting remote assistance request

1. Tap **SmartLink** on the Job menu of the tablet. The tablet automatically logs in the SmartLink system.



On-screen buttons:

- **Logout:** Exits the current account from the system.
- **Add a device:** Binds more SmartLink C device to the current account.
- **Post request:** Submits a new remote assistance order.

2. Tap the **Post Request** button to fill in the following information.

- In the **Device S/N** column, choose the desired SmartLink C Serial Number from the pull-down list if several SmartLink C is bound to the current account.
- In the **Vehicle information** column, enter the VIN manually and choose the right Make, Car model, Model year, Displacement, Engine type and Function.

*Note: In general, vehicle identification numbers are standardized - all contain 17 characters. VIN characters may be capital letters A through Z and numbers 1 through 0; however, the letters I, O and Q are never used in order to avoid mistakes of misreading. No signs or spaces are allowed in the VIN.

- In the **Contact information** column, input the phone number, E-mail address and name so that you can be reached by the remote SmartLink B in the shortest time.
 - In the **Problem Description** input box, it is highly recommended to describe the vehicle failure as accurate as possible because it is very helpful for the SmartLink B to have a general understanding of the vehicle status.
 - Tap **Link Platform Register Protocol** to read it carefully. After reading it, select the checkbox "I agree."
3. After filling the information, tap **Submit** to create the order.

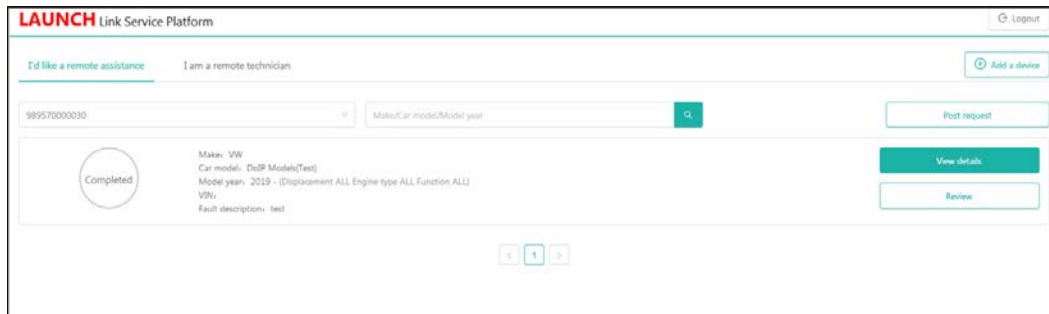

On-screen buttons:

- **View details:** Double check if the order information is correct or not.
- **Review:** Rates the service that has been already finished.

4. Next refer to Chapter 7.2.2 to make connections and start the diagnosis.

*Note: The remote SmartLink operation can only be performed after the SmartLink C has submitted the request, and this request has been accepted by the remote SmartLink B.

2. Connections & operations

Follow the steps below to proceed:

1. Turn off the vehicle ignition.
2. Connect one end of the OBD II extension cable into the OBD-16 diagnostic port of the SmartLink C device, and the other end into the vehicle's DLC port.

*Remarks: During the SmartLink diagnosis, especially during remote online programming, it is recommended that the vehicle battery is connected to a charging power source. Doing so can prevent the vehicle from running out of power and failing to start due to long diagnosis time.

3. Plug one end of CAT-6 crossover cable into the LAN/WLAN port of the SmartLink C device, and the other end into the LAN port of network modem.

*Note: The network broadband of 100MB and above is required for this operation.

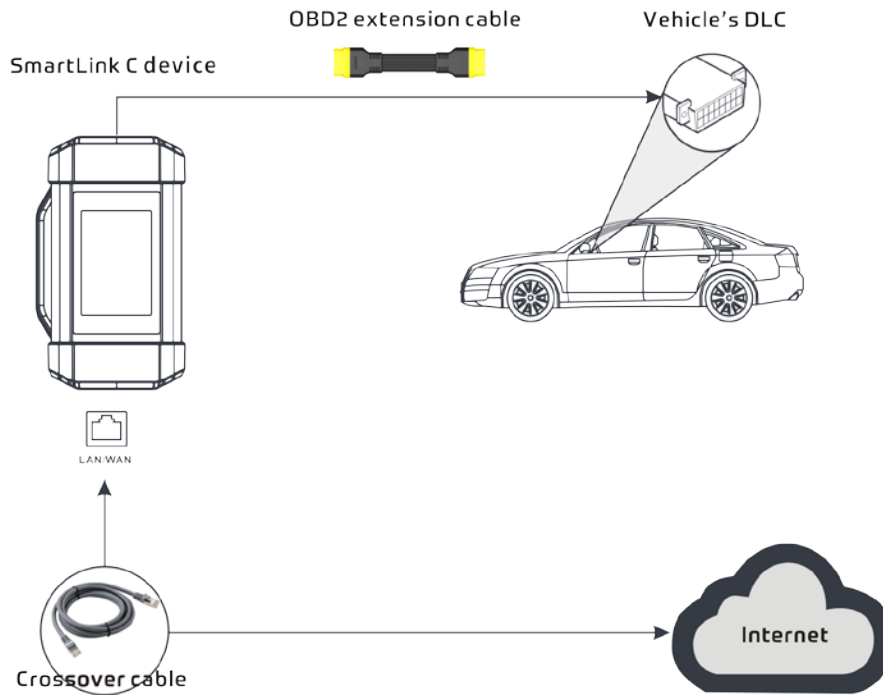

4. After a successful network connection, the SmartLink C screen displays prompt information asking whether to enter the super remote diagnostic mode. Tap **Yes**, the system will automatically read the vehicle information and connect to the remote diagnosis server.

*Note: One SmartLink C can only accept one remote diagnostic operation at one time.

5. Turn on the vehicle ignition.

*Remarks: After receiving the order, the SmartLink B master technician will accept the order and contact you via phone or E-mail address.

6. After a successful connection between the SmartLink C and SmartLink B is established, the following message will be displayed on the SmartLink C screen.

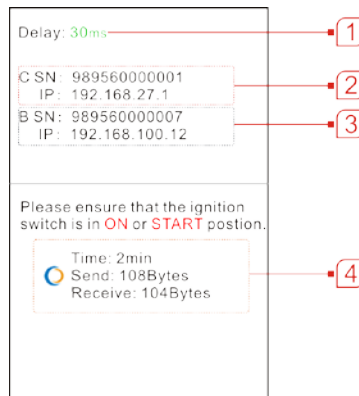

1	<p>Network delay status: Indicates the quality of the current network. Different colors represent different delay status. There are three states of network delay:</p> <ul style="list-style-type: none"> • Green: Indicates the network is normal. It is recommended that the diagnosis operation be performed when the network delay is green. Otherwise, the communication with the vehicle may fail or the incorrect system detection may occur. • Yellow: Indicates the network is not stable. Please keep it stable. • Red: Indicates the network delay is serious and not suitable for remote diagnosis or the network is disconnected. <p>*Remarks: If the displayed network is poor, there may be too many people using the network in the LAN and some users are downloading. It is recommended to use a stable network for remote diagnosis.</p>
---	---

2	The Serial Number and IP address of the current SmartLink C device.
3	The Serial Number and IP address of the connected SmartLink B device.
4	The duration of diagnosis process and package size of sent data/received data.

*Notes:

- Please do not interrupt the vehicle or network connection during a remote diagnostic process.
 - Please make sure that the network delay is in green state when performing a remote online programming process.
7. Unplug the crossover cable when a SmartLink operation is completed.

5.4 Diagnostic History

When a vehicle diagnosis is performed, the tablet records the detailed diagnostic information. The History function allows access to previously tested vehicle records. Testing can be resumed from the previous operation without starting from scratch.

Tap **Diagnostic History** on the home screen, all diagnostic records will be listed on the screen in date sequence.

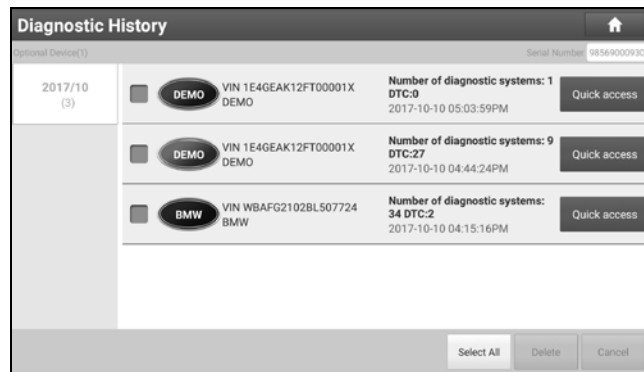

- Tap certain vehicle model to view the details of the last diagnostic report.
- To delete certain diagnostic history, select it and then tap **Delete**. To delete all historical records, tap **Select All** and then tap **Delete**.
- Tap **Quick access** to directly navigate to the function selection page of last diagnostic operation. Choose the desired option to proceed.

5.5 Feedback

This item allows you to feedback your diagnostic problems to us for analysis and troubleshooting.

Tap **Feedback**, a pop-up message will appear.

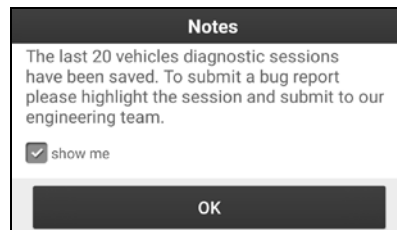

Tap **OK** to choose the vehicle diagnostic record page.

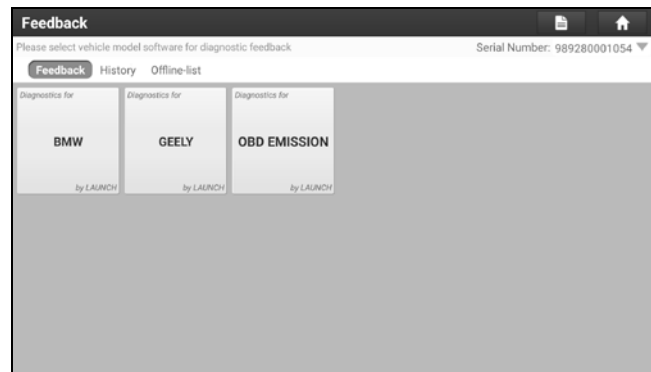

A. Feedback

Tap certain tested vehicle model to enter the feedback screen.

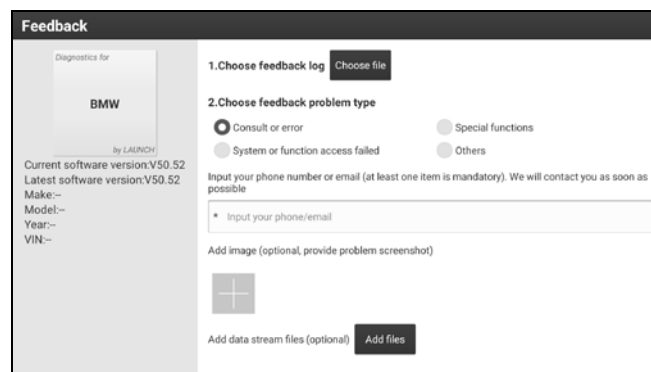

- 1) Tap **Choose File** to open the target folder and choose the desired diagnostic logs.
- 2) Choose the failure type and fill in the detailed failure description in the blank text box and telephone or email address. After inputting, tap **Submit Result** to send it to us.

B. History

Tap it to view all diagnostic feedback records. Different process states are marked with different colors.

C. Offline list

Tap it to display all diagnostic feedback logs which have not been submitted successfully due to network failure. Once the tablet gets a stable network signal, it will be uploaded to the server automatically.

6 Special (Reset) Function

Except that the special functions can be performed from the diagnostic menus (See Chapter 5.2.3) of certain vehicle model, this module provides an easy dial to quickly access the special functions.

The most commonly performed service functions contain:

- Oil Reset Service
- Electronic Parking Brake Reset
- Steering Angle Calibration
- ABS Bleeding
- TPMS (Tire Pressure Monitor System) Reset
- Gear Learning
- Injector Coding
- Battery Maintenance System
- Diesel Particulate Filter (DPF) Regeneration
- Electronic Throttle Position Reset
- Gearbox Matching
- AFS (Adaptive Front-lighting System) Reset
- Sunroof Initialization
- Suspension Calibration
- EGR Adaption
- Windows Calibration
- Seats Calibration
- Tyre Reset
- Language Change
- A/F Reset
- Coolant Bleed
- Transport Mode
- AdBlue Reset
- NOx Sensor Reset
- Stop/Start Reset

There are two methods to reset service lamp: Manual reset or Auto reset. Auto reset follows the principle of sending command from the tool to vehicle's ECU to do resetting. While using manual reset, users just follow the on-screen instructions to select appropriate execution options, enter correct data or values, and perform necessary actions, the system will guide you through the complete performance for various service operations.

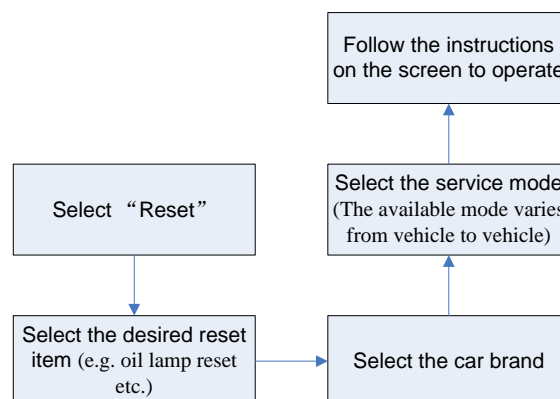

6.1 Oil Reset Service

This function allows you to perform reset for the engine oil life system, which calculates an optimal oil life change

interval depending on the vehicle driving conditions and climate.

This function can be performed in the following cases:

1. If the service lamp is on, you must provide service for the car. After service, you need to reset the driving mileage or driving time so that the service lamp turns off and the system enables the new service cycle.
2. After changing engine oil or electric appliances that monitor oil life, you need to reset the service lamp.

6.2 Electronic Parking Brake Reset

1. If the brake pad wears the brake pad sense line, the brake pad sense line sends a signal sense line to the on-board computer to replace the brake pad. After replacing the brake pad, you must reset the brake pad. Otherwise, the car alarms.
2. Reset must be performed in the following cases:
 - a) The brake pad and brake pad wear sensor are replaced.
 - b) The brake pad indicator lamp is on.
 - c) The brake pad sensor circuit is short, which is recovered.
 - d) The servo motor is replaced.

6.3 Steering Angle Calibration

To reset the steering angle, first find the relative zero point position for the car to drive in straight line. Taking this position as reference, the ECU can calculate the accurate angle for left and right steering.

After replacing the steering angle position sensor, replacing steering mechanical parts (such as steering gearbox, steering column, end tie rod, steering knuckle), performing four-wheel alignment, or recovering car body, you must reset the steering angle.

6.4 ABS Bleeding

This function allows you to perform various bi-directional tests to check the operating conditions of Anti-lock Braking System (ABS).

1. When the ABS contains air, the ABS bleeding function must be performed to bleed the brake system to restore ABS brake sensitivity.
2. If the ABS computer, ABS pump, brake master cylinder, brake cylinder, brake line, or brake fluid is replaced, the ABS bleeding function must be performed to bleed the ABS.

6.5 Tire Pressure Monitor System Reset

This function allows you to quickly look up the tire sensor IDs from the vehicle's ECU, as well as to perform TPMS replacement and sensor test.

1. After the tire pressure MIL turns on and maintenance is performed, the tire pressure resetting function must be performed to reset tire pressure and turn off the tire pressure MIL.
2. Tire pressure resetting must be performed after maintenance is performed in the following cases: tire pressure is too low, tire leaks, tire pressure monitoring device is replaced or installed, tire is replaced, tire pressure sensor is damaged, and tire is replaced for the car with tire pressure monitoring function.

6.6 Gear Learning

The crankshaft position sensor learns crankshaft tooth machining tolerance and saves to the computer to more accurately diagnose engine misfires. If tooth learning is not performed for a car equipped with Delphi engine, the MIL turns on after the engine is started. The diagnostic device detects the DTC P1336 'tooth not learned'. In this case, you must use the diagnostic device to perform tooth learning for the car. After tooth learning is successful, the MIL turns off.

After the engine ECU, crankshaft position sensor, or crankshaft flywheel is replaced, or the DTC 'tooth not learned' is present, tooth learning must be performed.

6.7 Injector Coding

Write injector actual code or rewrite code in the ECU to the injector code of the corresponding cylinder so as to more accurately control or correct cylinder injection quantity.

After the ECU or injector is replaced, injector code of each cylinder must be confirmed or re-coded so that the cylinder can better identify injectors to accurately control fuel injection.

6.8 Battery Maintenance System Reset

This function enables you to perform a resetting operation on the monitoring unit of vehicle battery, in which the original low battery fault information will be cleared and battery matching will be done.

Battery matching must be performed in the following cases:

- a) Main battery is replaced. Battery matching must be performed to clear original low battery information and prevent the related control module from detecting false information. If the related control module detects false information, it will invalidate some electric auxiliary functions, such as automatic start & stop function, sunroof without one-key trigger function, power window without automatic function.
- b) Battery monitoring sensor. Battery matching is performed to re-match the control module and motoring sensor to detect battery power usage more accurately, which can avoid an error message displaying on the instrument panel.

6.9 Diesel Particulate Filter (DPF) Regeneration

DPF regeneration is used to clear PM (Particulate Matter) from the DPF filter through continuous combustion oxidation mode (such as high temperature heating combustion, fuel additive or catalyst reduce PM ignition combustion) to stabilize the filter performance.

DPF regeneration may be performed in the following cases:

- a) The exhaust back pressure sensor is replaced.
- b) The PM trap is removed or replaced.
- c) The fuel additive nozzle is removed or replaced.
- d) The catalytic oxidizer is removed or replaced.
- e) The DPF regeneration MIL is on and maintenance is performed.
- f) The DPF regeneration control module is replaced.

6.10 Electronic Throttle Position Reset

This function enables you to make initial settings to throttle actuators and returns the “learned” values stored on ECU to the default state. Doing so can accurately control the actions of regulating throttle (or idle engine) to adjust the amount of air intake.

6.11 Gearbox Matching

1. This function can complete the gearbox self-learning to improve gear shifting quality.
2. When the gearbox is disassembled or repaired (after some of the car battery is powered off), it will lead to shift delay or impact problem. In this case, this function needs to be done so that the gearbox can automatically compensate according to the driving conditions so as to achieve more comfortable and better shift quality.

6.12 AFS (Adaptive Front-lighting System) Reset

This feature is used to initialize the adaptive headlamp system. According to the ambient light intensity, the adaptive headlamp system may decide whether to automatically turn on the headlamps, and timely adjust the headlamp lighting angle while monitoring the vehicle speed and body posture.

6.13 Sunroof Initialization

This function can set the sunroof lock off, closed when it rains, sliding / tilting sunroof memory function, temperature threshold outside the car etc.

6.14 Suspension Calibration

1. This function can adjust the height of the body.
2. When replacing the body height sensor in the air suspension system, or control module or when the vehicle level is incorrect, you need to perform this function to adjust the body height sensor for level calibration.

6.15 EGR Adaption

This function is used to learn the EGR (Exhaust Gas Recirculation) valve after it is cleaned or replaced.

6.16 Windows Calibration

This feature is designed to perform door window matching to recover ECU initial memory, and recover the automatic ascending and descending function of power window.

6.17 Seats Calibration

This function is applied to match the seats with memory function that are replaced and repaired.

6.18 Tyre Reset

This function is used to set the size parameters of the modified or replaced tire.

6.10 Language Change

This function is used to change the system language of the vehicle central control panel.

6.20 A/F Reset

This function is applied to set or learn Air/Fuel ratio parameters.

6.21 Coolant Bleed

Use this function to activate the electronic water pump before venting the cooling system.

6.22 Transport Mode

In order to reduce power consumption, the following functions may be disabled, including limiting the vehicle speed, not waking up the door opening network, and disabling the remote control key, etc. At this time, the transport mode needs to be deactivated to restore the vehicle to normal.

6.23 AdBlue Reset (Diesel Engine Exhaust Gas Filter)

After the diesel exhaust treatment fluid (car urea) is replaced or filled up, urea reset operation is required.

6.24 NOx Sensor Reset

NOx sensor is a sensor used to detect the content of nitrogen oxides (NOx) in engine exhaust. If the NOx fault is re-initialized and the NOx catalytic converter is replaced, it is necessary to reset the catalytic converter learned value stored in the engine ECU.

6.25 Stop/Start Reset

This function is used to open or close the automatic start-stop function via setting the hidden function in ECU (provided that the vehicle has a hidden function and supported by hardware).

7 Software Update

This module enables you to update the diagnostic software & App and frequently used software.

7.1 Update Diagnostic Software & APP

Go to **Software Update** on the Job Menu and tap the **Car model** tab.

The **Car model** tab displays a list of vehicle diagnostic software.

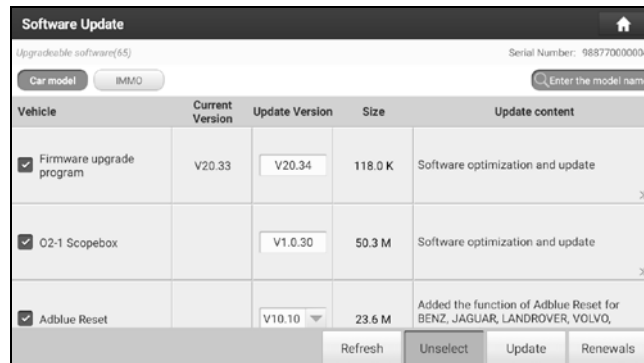

Tap **Update** to start downloading. Once download is finished, the software packages will be installed automatically.

7.2 Update IMMO&IMMO PROG Software

If the user only intends to update the IMMO&IMMO PROG software, go to Software Update and tap the **IMMO** tab.

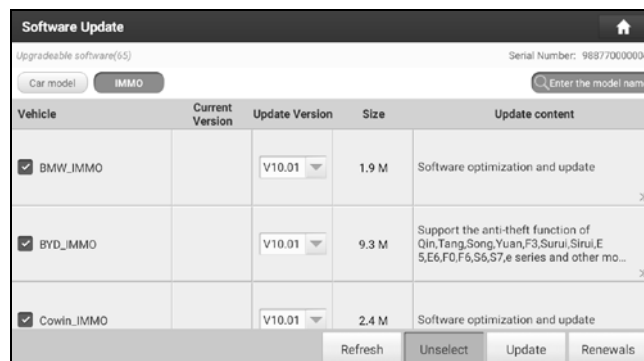

Tap **Update** to start downloading. Once download is finished, the software packages will be installed automatically.

7.3 Renew Subscription

If the software subscription is due or expires, the system will prompt you to renew your subscription and a **Renewal** button will appear on the bottom of the update page.

Tap **Renewal** to navigate to the payment screen.

Three ways are available for you to make payment: PayPal, Subscription Renewal Card (*need to buy it from the local dealer where you purchased the tool) and Credit Card.

A. Using PayPal

1. Tap **Renewal** on the update page to navigate to the renewal type selection screen.
2. Select **PayPal**, and then follow the on-screen instructions to finish the transaction.
3. After payment, go to update center to update the diagnostic software.

B. Using Subscription Renewal Card

1. Tap **Renewal** to navigate to the renewal type selection screen.
2. Select **Subscription Renewal Card**.
3. Input the 24-digit pin code of Subscription Renewal Card and then tap **Submit** to finish the renewal.
4. Go to update center to update the diagnostic software.

C. Credit Card

1. Tap **Renewal** on the update page to navigate to the renewal type selection screen.
2. Select **Credit Card**, and then follow the on-screen instructions to finish the transaction.

8 HD Software Package Purchase/Renewal

This module allows you extend the tablet to cover the commercial vehicles or renew the subscription of the expiry HD software package.

Go to **Local Diagnose** -> **Store**, the following screen will appear:

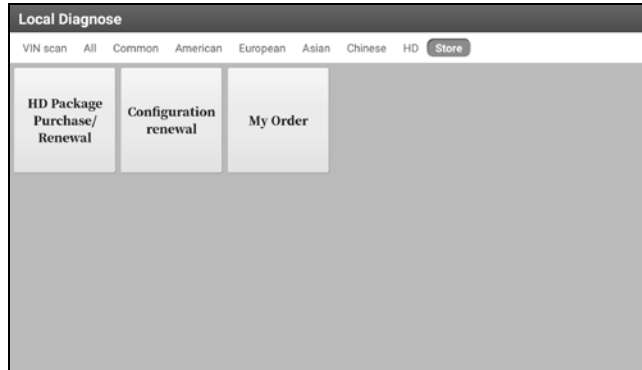

Tap **HD Package Purchase/Renewal**, the following screen will appear:

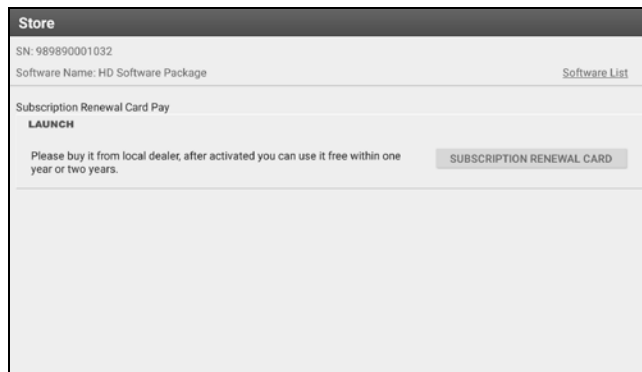

Tap **Software List** to check which vehicle diagnostic software is included in this package.

Tap **Subscription Renewal Card** to enter the following screen:



*Note: The Subscription Renewal Card can be ordered from the local dealer where you purchased the tool. Input the 24-digit pin code of Subscription Renewal Card and then tap **SUBMIT** to finish the renewal. Go to the **Software Update** module to update the diagnostic software.

9 Other Modules

9.1 ADAS (Calibration)

This module enables you to effectively and accurately calibrate a wide range of camera-based & radar-based driver assistance systems, e.g. the front camera for the lane departure warning system, the radar sensor for the ACC (Adaptive Cruise Control) or the camera for adaptive headlights. It needs to work with the specific ADAS calibration tool (sold separately).

For more details, please refer to the User Manual included with the module.

9.2 TPMS

This module allows you to configure the tablet as TPMS activation & diagnostic tool, which provides the ability to trigger TPMS sensor, program TPMS sensor, perform the relearning procedure. It needs to work with the compatible TSGUN device (sold separately).

For more details, please refer to the User Manual included with the module.

9.3 User Info

This function allows users to manage personal information and VCI.

9.3.1 My Report

This option is used to view, delete or share the saved reports.

Tap **Report**, there are total 3 options available.

In case the DTC result is saved on Read Trouble Code page, the files will be listed under **Health Reports** tab.

If user records the running parameters while reading data stream, the tablet will save the file which appears under **Recorded Data** tab.

Remote Reports lists all diagnostic reports generated in process of remote diagnosis.

9.3.2 VCI

This option allows you to manage all your activated VCI devices.

If several VCI devices are activated on this tool, a list of VCIs will be displayed on the screen. Once you choose the VCI that belongs to other account, you have to log out, and then input the right account to continue.

9.3.3 Activate VCI

This item lets you activate the VCI device in case you ignore the Activate VCI step in process of the product sign-up.

Input the Serial Number and Activation Code, and then tap **Activate** to activate it.

9.3.4 Fix Connector Firmware/System

Use this item to upgrade and fix VCI firmware/system. During fixing, please do not cut power or switch to other interfaces.

9.3.5 Sample

This feature allows you to manage the recorded data stream sample files.

9.3.6 Vehicle Voltage

This item performs a check of the vehicle's battery to ensure the system is operating within acceptable limits.

9.3.7 My Order

This item allows you to check the status of all your orders.

9.3.8 Subscription Renewal Card

This item is used to check the status of the subscription renewal card.

Input the 12-digit subscription renewal card number. Tap **Search** to get the search result.

9.3.9 Profile

Use this item to view and configure personal information.

- The profile description includes a 'placeholder' for a user photograph. Tap the user image to change it.
- Tap > next to **Upgrade Period** to check the due date of all diagnostic software.

9.3.10 Change Password

This item allows you to modify your login password.

9.3.11 Settings

It enables you to make some application settings and view software version information etc.

1. Units of measurement

It is designed to configure the measurement unit. Metric System and English System are available.

2. Shop information

This option lets you define your print information. It mainly includes Workshop, Address, Telephone, Fax and License Plate.

After inputting, tap **Save**.

Once you saved the print information, it will be entered automatically in the "Add Information" box every time you save the diagnostic report.

3. Printer set

This option is designed to establish a wireless connection between the tablet and the Wi-Fi printer (sold separately) while performing printing operations.

The App is compatible with the **LAUNCH Wi-Fi Printer** (sold separately) and **System** (external printer).

For LAUNCH Wi-Fi printer, follow the steps below to connect the printer.

1. Tap **Printer Set**.

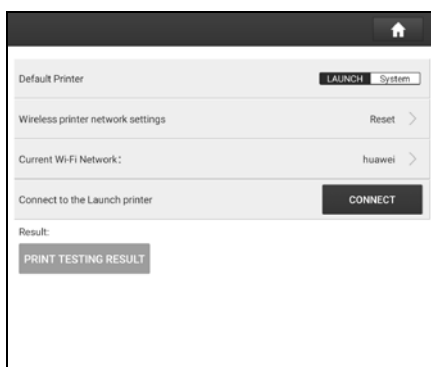

A. If it is the first time you have operated this printer, please proceed the following:

1. For initial use, you are suggested to reset the printer: Press and hold **MODE & FEED** for 8 seconds, the following resetting command will be printed out:

```
at + default = 1
ok
at + reboot = 1
rebooting...
```

2. Tap **Reset** to configure Wi-Fi printer.

Step 1: Connect the printer:

Tap **Scan** to start scanning and select the desired printer hotspot named with X-431PRINTER-XXXX (XXXX stands for 4 characters), and then tap **Connect** to enter Step 2.

Step 2: Join the Wi-Fi printer into LAN:

Tap **Scan** to select the desired local Wi-Fi network from the list, and type in the security password (If it is an open network, password is not required), and then tap **Confirm**.

3. Once the Wi-Fi network of the printer is connected and the printer is found, tap **Printing test** to test the printing.

Now the Wi-Fi printer is ready for printing.

If the printer is not found, please reset the printer to default factory settings (refer to Step 2 for details) and check whether the current device and the printer are on the same LAN.

B. If you have configured the Wi-Fi printer to the LAN:

2. Tap **Connect to Printer**:

- a). If the local network remains as it is, tap **Test Print** directly to test the printing.
- b). If the local network changes, you have to reset the Wi-Fi printer.

For other Wi-Fi printers,

Before printing, make sure the following conditions are met:

- The Wi-Fi printer is powered on and working normally.
- The print service plug-in associated with the printer is already installed on the tablet (Go to Google Play or use the Browser to download and install it).

Follow the steps below to proceed:

1. Set the default printer as **System**.
2. Go to **Other Modules -> Built-in apps -> Tablet Settings -> WLAN**, set the WLAN switch to Off.
3. On the report details page, tap .



4. Touch ▼ next to **Select a printer** on the upper left corner of the screen.

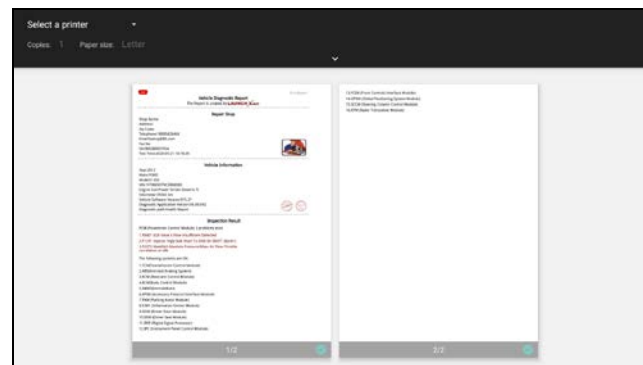

5. Select **All Printers -> Add printer** and enable the installed printer service, the system starts searching for all available Wi-Fi printers of the brand.

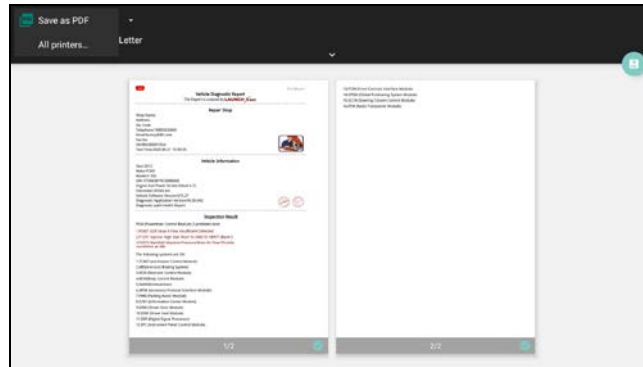

6. Select the desired Wi-Fi printer from the list. If the chosen Wi-Fi printer hotspot is open, the tablet can connect it directly. If it is encrypted, a password may be required. Refer to the Wi-Fi printer user manual to get the default password.
7. Now the printer is ready for printing.
8. Alternatively, you can also choose **Save as PDF** to save the current diagnostic report as a PDF file for later printing.

4. Clear cache

This item is used to clear the App cache.

Tap **Clear Cache**, a pop-up window will appear on the screen. Tap **OK** to clear cache and the system will restart the App.

5. About

The software version information and disclaimer are included.

6. Diagnostic software auto update

This option is used to set whether automatic update function is ON.

7. Device account management

This option is used to manage the sub-accounts. The added sub-account allows the VCI connector to be used by different users to log in the tool, which is convenient for multiple VCIs to perform diagnostic service at the same time.

The newly added sub-account has a one-year validity period. After the expiration, the VCI bound to the sub-account cannot be used and the sub-account will no longer enjoy the rights and interests of the main account. The main account can modify the validity period of the sub-account.

There are two types of sub-accounts: one is an existing account and the other is a newly created account. The main account has the functions of adding and removing sub-accounts, the sub-account can also be unbound from the main account.

Tap **Device account management**, the following screen will appear:

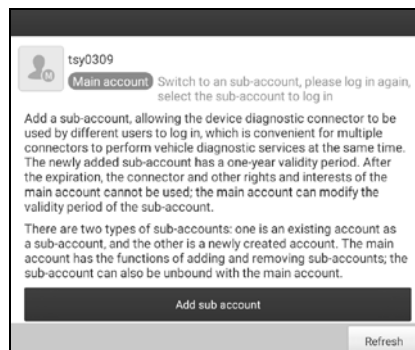

Tap **Add sub account**, the following popup will appear:

If you already have an account, please enter the user name and password. After inputting, tap **Add Immediately** to add it as a sub-account.

If you have not registered any account, tap **Create sub user**. Enter the user name and password, and then tap **Add Immediately** to add it as a sub-account.

After adding the sub-account, the following screen will appear:

To unbind it from the main account, tap **Remove**. To revise the validity period, tap **Change**.

8. Login/Log out

To logout the current user ID, tap **Log Out**.

To login the system again, tap **Login**.

9.3.12 Diagnostic Software Clear

This item allows you to hide/clear the diagnostic software that is not frequently used.

*Note: Removing software may completely delete the software from the tablet. If some software is not used and the tablet runs out of space, you can use this feature to remove it. To re-download it, go to **Software Update** -> **All Software**.

9.4 Toolbox

This function includes the following add-on modules: Oscilloscope, Ignition, Sensor, Multimeter, Battery Tester and Videoscope.

Each module consists of two parts: hardware and app. These modules cannot work properly on the tablet, which need to work with the specific compatible hardware (sold separately). For detailed operations, refer to the User Manual of each module.

9.4.1 Oscilloscope

The Oscilloscope is an optional add-on module of X-431 IMMO PAD, including automotive oscilloscope and automotive ignition waveform.

Automotive oscilloscope can make the auto repair technician quickly judge the faults on automotive electronic equipment and wiring, and the oscilloscope sweep speed is far greater than the signal frequency of such vehicles, usually 5-10 times of the measured signal.

X-431 IMMO PAD also provides an optional function of Ignition Scope, which can test and analyze the secondary signal for various engine ignition systems.

9.4.2 Sensor Simulator

This module is specially designed to diagnose and simulator vehicle sensor faults quickly and conveniently. It needs to work with the compatible S2-2 Sensorbox (sold separately).

For more details, please refer to the User Manual included with the module.

9.4.3 Multimeter

This module allows you to measure the physical parameters such as voltage, resistance, frequency etc. It utilizes the same hardware as the S2-2 Sensorbox.

For more details, please refer to the User Manual included with the S2-2 Sensorbox.

9.4.4 Battery Tester

This module allows you to fix battery detection faster and easier. It needs to work with the specific Bluetooth battery tester (sold separately).

For more details, please refer to the User Manual included with the module.

9.4.5 Videoscope

This module allows you to check those unseen parts of engine, fuel tank, braking system. It needs to work with the compatible Videoscope device (sold separately).

For more details, please refer to the User Manual included with the module.

9.5 TeamViewer

This function enables you to receive remote support from technician fellows, colleagues or friends by allowing them to control your tablet on their computer view TeamViewer software.

On the home screen, tap **Other modules -> Built-in apps -> TeamViewer**. The following screen will appear:



*Note: In order to provide support and take control of your tablet remotely, your partner needs to install and run the TeamViewer full version program in his computer, and have your TeamViewer ID. Visit <http://www.teamviewer.com> for details.

9.6 Wireless Upgrade

An Over-the-Air (OTA) update is the wireless delivery of new operating system, software or data to tablets and mobile phones. Wireless carriers have traditionally used over-the-air updates to deploy firmware and configure phones or tablets for use on their network. The initialization of a newly purchased tablet required an over-the-air update.

*Note: While performing OTA update, please make sure the tablet battery has at least 70% and DO NOT run any other programs during the update.

1. On the home screen, tap **Other modules -> Built-in apps -> Wireless Upgrade**.

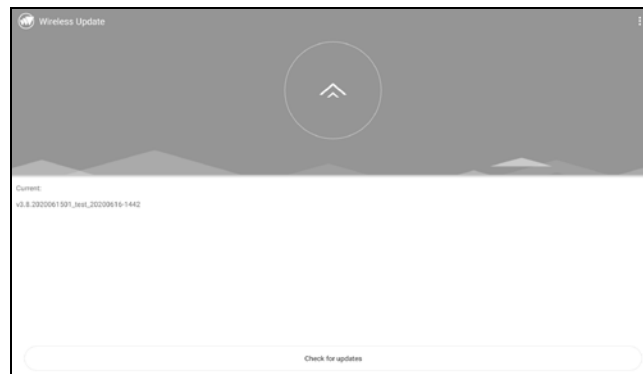

2. Tap **Check for updates**. Once a newer version is found, follow the on-screen instructions to download and install the update file.
3. Be patient to wait until the update is done.

9.7 File Explorer

ES File Explorer is a file and application manager. You can access and create folders on the tablet without needing to connect it to a computer.

The app also features an application manager, task killer and download manager. Another excellent feature is support for cloud storage accounts. This means you can download files directly to the folders you want without using a separate app.

The app has built-in ZIP and RAR sources, so you can access compressed files without unpacking them on your computer first.

For more information, please refer to the associated ES file explorer documents.

9.8 Gallery

This function allows you to take new pictures and manage the picture library (including screenshots).

10 J2534 Reprogramming Using SmartLink C

Flash programming has become a common and profitable procedure in the repair and service of today's vehicles. As part of the 21st Century Tune-up, reprogramming is often the only solution for problems ranging from driveability and loss of power to poor fuel economy and emissions related issues. SmartLink C makes it easy. The SmartLink C is a communication interface designed to support J2534 specifications for ECU reprogramming.

Except that the SmartLink C can act as a VCI device and a SmartLink dongle, it also can be used as a J2534 PassThru device, working together with the PC installed with the OEM diagnostic software to perform the J2534 reprogramming. In this case, the PC needs to install with the LAUNCH's J2534 tool, which can be downloaded from the official website at www.cnlaunch.com.

10.1 As a Local J2534 PassThru Device

Except that the SmartLink C acts as a VCI device and a SmartLink dongle, it also can be used as a J2534 PassThru device, working together with the PC installed with the OEM diagnostic software to perform the J2534 reprogramming. In this case, the PC needs to install with the LAUNCH's J2534 tool, which can be downloaded from www.cnlaunch.com.

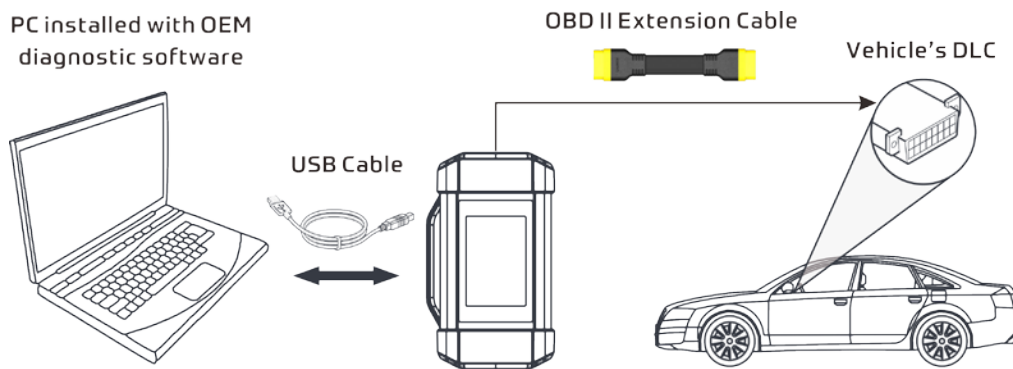

10.2 As a Remote J2534 PassThru Device

Besides local ECU reprogramming, remote ECU reprogramming function is also supported using SmartLink C.

*Before diagnosing, please make sure the following conditions are met:

- The SmartLink C device is connected to the Internet and has a strong network signal.
- The OEM diagnostic software has been installed on the PC.
- The LAUNCH's J2534 tool also needs to be installed on the PC. This tool and its associated operation instruction documentation can be downloaded from www.cnlaunch.com.

Ensure that the remote reprogramming operation is performed after the SmartLink C is connected to the vehicle's DLC port and the Internet, and has been switched to the super remote diagnosis mode. For specific operations, please refer to other associated documentation.

PC installed with OEM diagnostic software



Vehicle's DLC

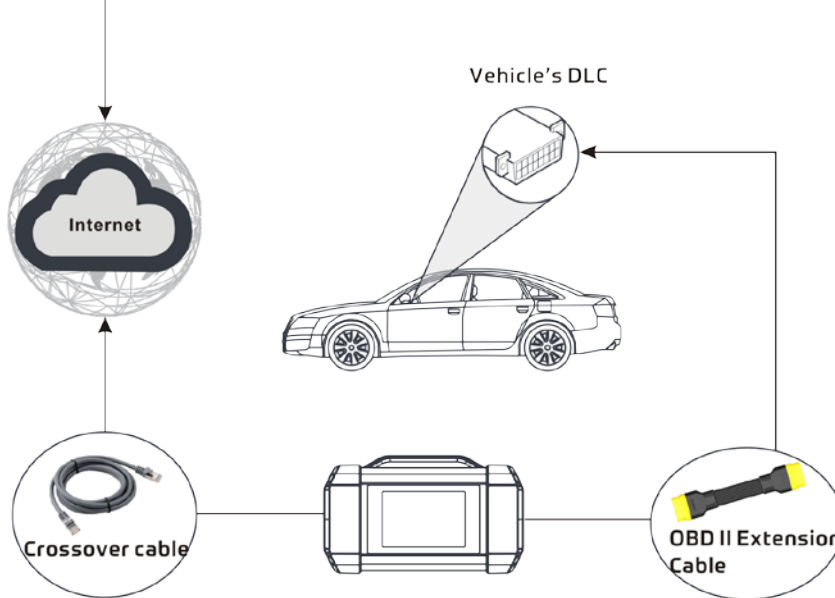
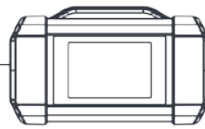

11 Synchronization

You can transfer media files and APK between the tablet and a computer.

1. Connect the tablet to a computer via the included USB cable.
2. Swipe the screen from the top, tap  -> **USB Management**.

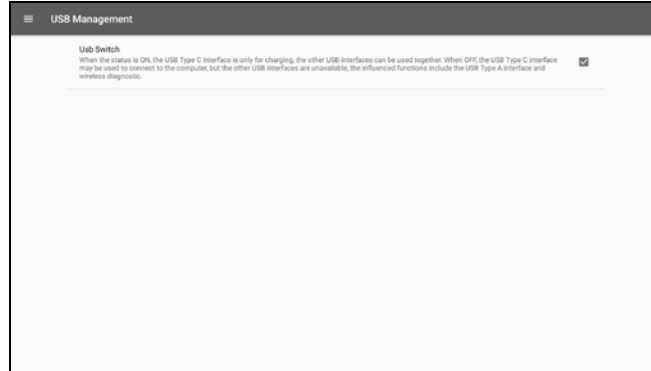

3. Deselect the USB Switch.
4. Swipe the screen from the top, tap , the following screen will appear:

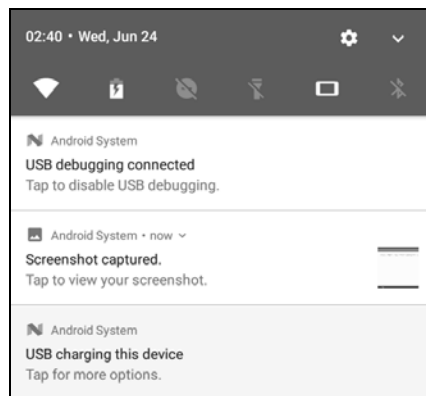

5. Tap **USB charging this device**, the following screen will appear:

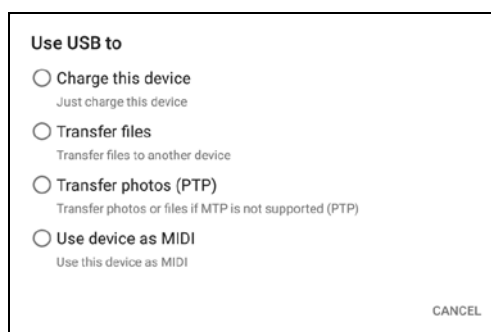

6. Select **Transfer files**. Now you can copy files between the tablet and the computer.

12 FAQ

12.1 About X-431 IMMO PAD

1. How to save power?

1. Please turn off the screen while the tool keeps idle.
2. Set a shorter standby time.
3. Decrease the brightness of the screen.
4. If WLAN connection is not required, please turn it off.

2. Communication error with vehicle ECU?

Please confirm:

1. Whether the VCI is correctly connected.
2. Whether ignition switch is ON.
3. If all checks are normal, send vehicle year, make, model and VIN number to us using Feedback feature.

3. Failed to enter into vehicle ECU system?

Please confirm:

1. Whether the vehicle is equipped with this system.
2. Whether the VCI is correctly connected.
3. Whether ignition switch is ON.
4. If all checks are normal, send vehicle year, make, model and VIN number to us using Feedback feature.

4. How to reset the tablet?

 Resetting may cause data loss. Before doing so, please make sure important data and information has been backed up.

Do the following to reset the tablet:

1. Tap **Settings -> Back & Reset**.
2. Tap **Factory data reset**.
3. Tap **Reset tablet**.
4. Tap **Clear all data** to start resetting until the tool automatically reboots.

5. How to download the X-431 IMMO PAD App after resetting the tablet?

*Note: Before registration, please make sure the network is properly connected.

After the tablet has been successfully reset, follow the steps below to download the App:

1. Launch the browser and the default official Launch website opens (If a blank page pops up, just type in www.x431.com in the input bar).
2. Tap **Login**, input the username and password and tap **Log In**.
3. Make sure that the serial number is correct, tap **APP application program** and tap the Download icon to start downloading.
4. After the download is complete, follow the on-screen instructions to install it.
5. After installation, use the existing username and password to login and go to update center to download the diagnostic software.

6. What to do if the language of vehicle diagnostic software does not match the system language?

English is the default system language of the tool. After the system language is set to the preference language, please go to the update center to download the vehicle diagnostic software of the corresponding language.

If the downloaded diagnostic software is still displayed in English, it indicates that the software of the current language is under development.

7. How to retrieve the login password?

Please follow below steps to proceed in case you forgot the login password:

1. Tap the application icon on the home screen to launch it.
2. Tap the **Login** button on the upper right corner of the screen.
3. Tap **Retrieve password**.
4. Input product S/N and follow the on-screen prompts to retrieve the password.

12.2 About SmartLink Diag.

1. What's network conditions is required for SmartLink Diag.?

The remote SmartLink Diag. operation requires a network broadband of 100 MB or above.

2. What does the word "Delay" displayed on the SmartLink C screen mean?

The Delay (network delay) indicates the quality of the current network. Different colors represent different delay status. There are three states of network delay:

Green: Indicates the network is normal. It is recommended that the diagnosis operation be performed when the network delay is green. Otherwise, the communication with the vehicle may fail or the incorrect system detection may occur.

Yellow: Indicates the network is not stable. Please keep it stable.

Red: Indicates the network delay is serious and not suitable for remote diagnosis or the network is disconnected.

3. Why is the network connection so poor?

If the displayed network is poor, there may be too many people using the network in the LAN and some users are downloading. It is recommended to use a stable network for remote SmartLink diagnosis.

4. Why does the sign appear on the upper right corner of the SmartLink C screen?

Some networks have firewall restriction which leads to a longer delay of connection. You are most likely to see this sign while your system is in connection with networks managed by communities or companies. It is recommended to use the networks directly installed by telecommunication operators where there is no firewall restriction.

5. Some systems of some old vehicles cannot be tested

The SmartLink C device supports CANBUS and DoIP communication protocols, but some old vehicle uses K-Line communication protocol.

6. Is it necessary to re-ignite the car after the diagnostic system starts working?

For the sake of some vehicle's conditions, the re-ignition will provide you a more detailed analysis after OBD diagnosis.

7. Can I charge the SmartLink C device through an external DC power supply?

No. The SmartLink C device obtains power only through a vehicle's OBD diagnostic socket. Getting power through an external DC power supply could result in system malfunction.

8. How to update SmartLink C system?

After the SmartLink C device is powered on and connected to the network, a message "Whether to upgrade now?" will be displayed if a new system version is detected. Tap **Yes** to start updating, wait until the upgrade is complete.

13 Glossary of Terms & Abbreviations

ABS – Anti-Lock Brake System

AC – Alternative Current

ADAS -- Advanced Driver Assistance Systems

AFS – Adaptive Front-lighting System

CAN – Controller Area Network

Communication Protocol – Allows different systems and sensors in a vehicle to communicate.

There are currently five Protocols:

- CAN Bus
- J1850 VPW
- ISO 9141-2
- J1850 PWM
- ISO 14230 KWP

DC – Direct Current

DLC – Data Link Connector

The 16-cavity connector on the vehicle that allows communication between the computer system and the diagnostic tool.

DPF – Diesel Particulate Filter

DTC – Diagnostic Trouble Code

A code stored in the computer system's memory, which helps to identify the fault condition that is causing the MIL to activate.

Drive Cycle – A set of driving procedures that, when met, provide the Enabling Criteria for the I/M Monitors to run and complete their diagnostic tests.

Freeze Frame Data – A digital representation of engine and/or emissions system conditions present when a fault code was recorded.

Generic Code – A DTC that applies to all OBD2 compliant vehicles.

I/M – Instant Messaging

I/M Readiness – An indication of whether or not a vehicle's emissions-related system are operating properly and are ready for Inspection and Maintenance testing.

LCD – Liquid Crystal Display

LED – Light Emitting Diode

Manufacturer Specific Code – A DTC that applies only to OBD II-compliant vehicles made by a specific manufacturer.

MIL – Malfunction Indicator Lamp

The vehicle's "Check Engine" warning light that activates when a DTC is stored.

OBD I – On-Board Diagnostics Version 1

OBD II – On-Board Diagnostics Version 2

OEM – Original Equipment Manufacturer

PID – Parameter Identification Data

Data returned by the vehicle's Control Modules to the diagnostic tool.

TPMS – Tire Pressure Monitor System

VCI – Vehicle Communication Interface

WLAN – Wireless Local Area Network

Warranty

THIS WARRANTY IS EXPRESSLY LIMITED TO PERSONS WHO PURCHASE LAUNCH PRODUCTS FOR PURPOSES OF RESALE OR USE IN THE ORDINARY COURSE OF THE BUYER'S BUSINESS.

LAUNCH electronic product is warranted against defects in materials and workmanship for one year from date of delivery to the user.

This warranty does not cover any part that has been abused, altered, used for a purpose other than for which it was intended, or used in a manner inconsistent with instructions regarding use. The exclusive remedy for any automotive meter found to be defective is repair or replacement, and LAUNCH shall not be liable for any consequential or incidental damages.

Final determination of defects shall be made by LAUNCH in accordance with procedures established by LAUNCH. No agent, employee, or representative of LAUNCH has any authority to bind LAUNCH to any affirmation, representation, or warranty concerning LAUNCH automotive meters, except as stated herein.

Disclaimer

The above warranty is in lieu of any other warranty, expressed or implied, including any warranty of merchantability or fitness for a particular purpose.

Purchase Order

Replaceable and optional parts can be ordered directly from your LAUNCH authorized tool supplier. Your order should include the following information:

Order quantity

Part number

Part name

Customer Service

Any question during the operation, please call 86-755-84528722.

If your unit requires repair service, return it to the manufacturer with a copy of the sales receipt and a note describing the problem. If the unit is determined to be in warranty, it will be repaired or replaced at no charge. If the unit is determined to be out of warranty, it will be repaired for a nominal service charge plus return freight. Send the unit pre-paid to:

Attn: Customer Service Department

LAUNCH TECH. CO., LTD.

Launch Industrial Park,

North of Wuhe Avenue,

Banxuegang, Bantian,

Longgang, Shenzhen, Guangdong

P.R.China, 518129

Launch website: <http://www.cnlaunch.com>

<http://www.x431.com>

Statement:

LAUNCH reserves the rights to make any change to product designs and specifications without notice. The actual object may differ a little from the descriptions in the manual in physical appearance, color and configuration. We have tried our best to make the descriptions and illustrations in the manual as accurate as possible, and defects are inevitable, if you have any question, please contact local dealer or after-sale service center of LAUNCH, LAUNCH does not bear any responsibility arising from misunderstandings.