

FICHA TÉCNICA

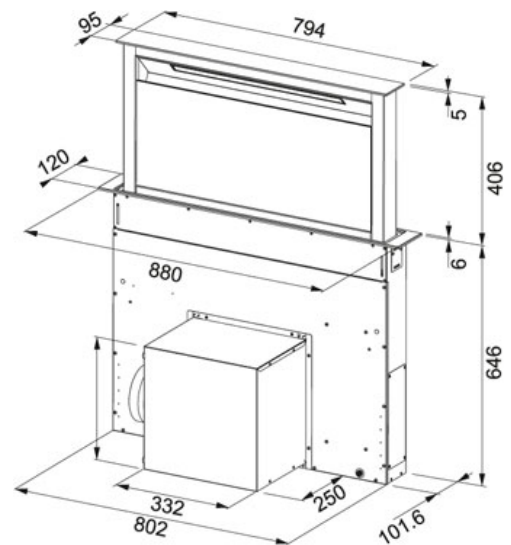









GAMA DE PRODUCTO: Campanas ACABADO: Acero Inoxidable - Negro SERIE: DOWNDRAFT MODELO: FDW 908 IB XS



Información de producto

Número de Artículo	110.0260.620
Clase de eficiencia energética	C
Tipo de campana	Downdraft
Ancho	88
Número de velocidades	4+int.
Aspiración en Int. (UNE EN-61591)	710 m3/h
Aspiración en Máx. (UNE EN-61591)	530 m3/h
Aspiración en Mín. (UNE EN-61591)	220 m3/h
Pot. sonora en Int. (UNE EN-60704-3)	70 dB(A)
Pot. Sonora en Máx. (UNE EN-60704-3)	65 dB(A)
Pot. Sonora en Mín. (UNE EN-60704-3)	46 dB(A)
Potencia Máx. (W)	275 W
Filtro	Aluminio multicapa
Iluminación	LED bar 1x10W
Tipo de Mandos	Touch control
Salida	Ø 150 mm
Filtros Carbón Activo	No incluido

Características

-  Función Filtrante
-  4 Velocidades + Intensiva
-  Nuevo
-  Indicador de saturación de filtros
-  Aspiración Perimetral
-  Luz confort
-  Temporizador de Apagado
-  Panel de Control Digital
-  Admite Control Remoto
-  Clase de eficiencia energética C