

SPECIFICATION SHEET

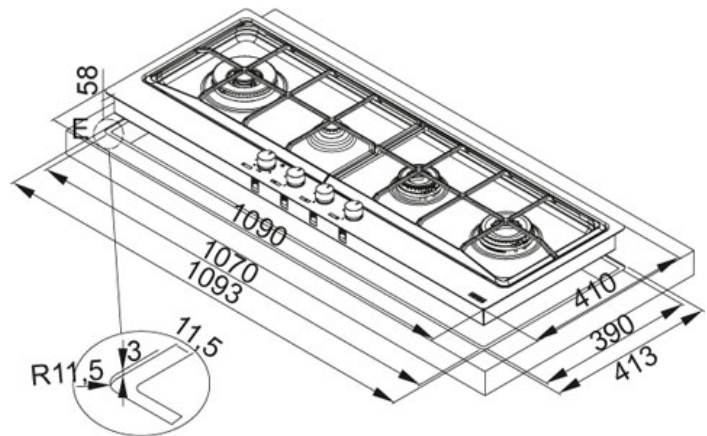







FAMIGLIA: Piani Cottura FINITURA: Inox satinato SERIE: NEPTUNE FILOTOP MODELLO: FHNE 1204 3G TC XS FM C



Caratteristiche

| | |
|-----------------------------|--|
| Articolo | 106.0064.318 |
| Codice | 6600068 |
| Numero Fuochi | 4 |
| Potenza (W) | Ausiliario 1000W Semirapido doppia corona chef 2500W Rapido doppia corona chef 3000W Tripla corona dual 4000W |
| Valvola di sicurezza | Si |
| Griglie in dotazione | Ghisa |
| Dimensioni | 1090x410 |
| Foro Incasso | Vedi dima |
| Profondità Cassetto | 58 |
| Prodotto consigliato | Kit sigillante (0396945) per installazione filotop |

Funzioni

| | | | |
|---|----------------------------------|---|--------------------|
|  | Accensione elettronica integrata |  | Cottura ribassata |
|  | Griglie in ghisa in dotazione |  | Doppia corona |
|  | Valvola di sicurezza |  | Nuovo |
|  | AISI 304 |  | Tripla corona dual |