

Contents

Language

Page

English

1

French

38

Spanish

79

Topic	Page
Inventory of Contents	2
Features	3
Setting Up	5
Battery Installation	7
Function keys	9
LCD Screen and Settings	11
Manual Settings	13
Weather Forecast and Tendency	17
Display of Indoor Temperature and Humidity Reading	23
Display of Outdoor Temperature Reading	24
Display of Indoor Maximum and Minimum records	24
Display of Outdoor Maximum and Minimum records	26
915 MHz Reception	27
Mounting	28
Care and Maintenance	31
Specifications	32
Warranty Information	34

This product offers:



INSTANT TRANSMISSION is the state-of-the-art new wireless transmission technology, exclusively designed and developed by LA CROSSE TECHNOLOGY. ***INSTANT TRANSMISSION*** offers you an immediate update (every 4 seconds!) of all your outdoor data measured from the sensors: follow your climatic variations in real-time!

INVENTORY OF CONTENTS

1. Wireless Weather Station
2. Wireless Outdoor Temperature Sensor (TX37U) and mounting bracket.
3. Instruction Manual.

FEATURES:

The Weather station

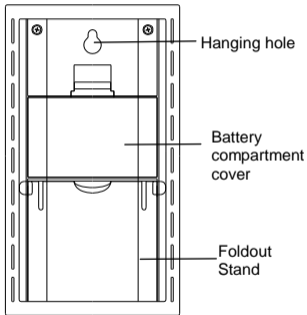
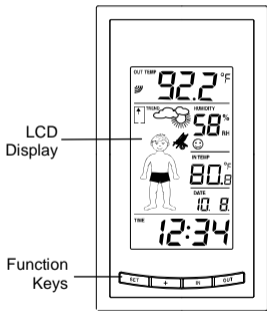

- Manual time setting
- 12/24 hour display
- Hour and minute display
- Wireless transmission at 915 MHz
- Signal reception intervals at 4-second
- Display indoor and outdoor temperature and indoor humidity (% RH)
- Temperature displayed in degrees Fahrenheit (°F) or Celsius (°C) selectable
- Weather forecasting with 15 easy-to-read weather forecast signs featured by Weather man
- Indoor comfort level indicator
- Indoor and Outdoor temperature display with MIN/MAX recording
- All MIN/MAX recordings can be reset
- Low battery indicator
- Table standing/ Wall mounting

The Outdoor Temperature Sensor

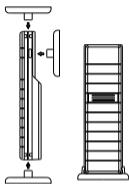

- Remote transmission of outdoor temperature to Weather Station by 915 MHz
- Shower proof casing
- Wall mounting case (Mounting at a sheltered place. Avoid direct rain and sunshine)

SETTING UP:

Note: This weather station receives only **one** outdoor sensor.

IMPORTANT:

Please place the Weather station at least 5 feet away from the Sensor **before inserting the batteries in the units** in order for the Sensor to transmit accurate initial data to the Weather station.

1. First, insert the batteries into the Temperature sensor. (see “**Install and replace batteries in the Temperature sensor**”).
2. Immediately after and within 30 seconds, insert the batteries into Weather station (see “**Install and replace batteries in the Weather station**”). Once the batteries are in place, all segments of the LCD will light up briefly. Following the time as 12:00 and the "Weather man" icon will be displayed. If these are not displayed after 60 seconds, remove the batteries and wait for at least 10 seconds before reinserting them.
3. After inserting the batteries, the Weather station will start receiving data from the sensor. The outdoor temperature and the signal reception icon should then be displayed on the Weather station. If this does not happen after 3 minutes, the batteries will need to be removed from both units and reset from step 1.
4. In order to ensure sufficient 915 MHz transmission however, this should under good conditions be a distance no more than 100 meters between the final position of the Weather Station and the sensor (see notes on “**Mounting**” and “**915 MHz Reception**”).

Note:

- If the signal reception is not successful on the first frequency (915MHz) for 45 seconds, the frequency is changed to 920MHz and the learning is tried another 45 seconds. If still not successful

the reception is tried for 45 seconds on 910MHz. This will also be done for re-synchronization.

BATTERY INSTALLATION

INSTALL AND REPLACE BATTERIES IN THE WEATHER STATION

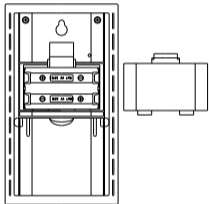

The Weather station uses 2 x AA, IEC LR6, 1.5V batteries. To install and replace the batteries, please follow the steps below:

1. Remove the cover at the back of the Weather station.
2. Insert batteries observing the correct polarity (see marking).
3. Replace compartment cover.

INSTALL AND REPLACE BATTERIES IN THE TEMPERATURE SENSOR

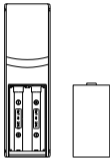

The Temperature Sensor uses 2 x AA, IEC LR6, 1.5V batteries. To install and replace the batteries, please follow the steps below:

1. Remove the battery compartment cover at the back of the sensor.
2. Insert the batteries, observing the correct polarity (see marking).
3. Replace the battery compartment cover on the unit.

Note:

In the event of changing batteries in any of the units, all units need to be reset by following the setting up procedures. This is because a random security code is assigned by the sensor at start-up and this code must be received and stored by the Weather station in the first 3 minutes of power being supplied to it.

BATTERY CHANGE:

It is recommended to replace the batteries in all units regularly to ensure optimum accuracy of these units (Battery life See **Specifications** below).



Please participate in the preservation of the environment. Return used batteries to an authorised depot.

FUNCTION KEYS:

Weather station:

The weather station has four easy to use function keys.

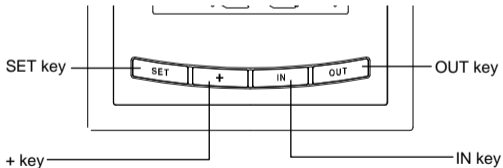

SET key

- Press and hold the key to enter manual setting modes: Manual time, Calendar, 12/24 hour display and Temperature unit °F/°C setting

+ key

- To make adjustment for various settings

IN key

- Press to display the MIN and MAX indoor temperature records
- Press and hold to reset the indoor MIN/MAX temperature records

OUT key

- Press to display the MIN and MAX outdoor temperature records
- Press and hold to reset the outdoor MIN/MAX temperature records

LCD SCREEN AND SETTINGS:

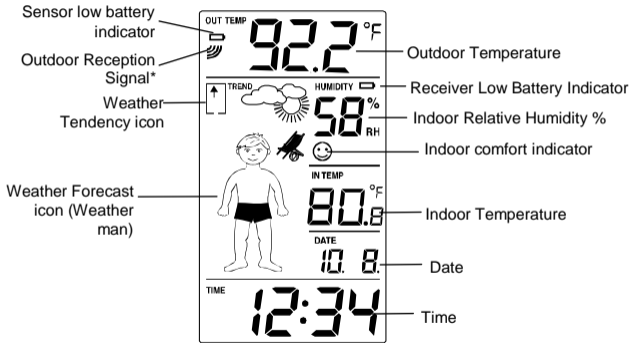

*When the outdoor signal is successfully received by the Weather Station, this icon will be switched on. (If not successful, the icon will not be shown in LCD) So user can easily see whether the last reception was successful (icon on) or not (icon off). On the other hand, the short blinking of the icon shows that a reception is currently taking place.

For better distinctness the LCD screen is split into 3 sections:

Section 1 - OUTDOOR TEMPERATURE

- Display the outdoor temperature.
- Display the signal reception symbol indicating that receiver is receiving outdoor data

Section 2 - INDOOR TEMPERATURE, INDOOR HUMIDITY, DATE AND WEATHER MAN ICON

- Display the current indoor temperature and humidity in normal display.
- Display the weather condition to be expected in form of 15 fancy weather symbols (featured by Weather man) which change their appearance depending on the air pressure development and the current outdoor temperature.
- Display the weather tendency indicator and indoor comfort level indicator
- Display the date

Section 3 - TIME

- Display the current time.

MANUAL SETTINGS:

The following manual settings can be done in the setting mode:

- Manual time
- Calendar
- 12/24 hour display
- Temperature unit °F/°C setting

Press and hold the SET key for about 3 seconds to advance to the setting mode:

MANUAL TIME SETTING



To set the clock:

1. The hour digits start flashing in the time display section.
2. Use the + key to adjust the hours and then press SET key to go to the minute setting.
3. The minute will be flashing. Press the + key to just the minutes.
4. Confirm with the SET key and enter the **"Calendar Setting"**.

CALENDAR SETTING

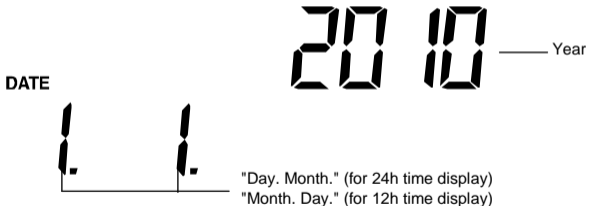

The date default of the Weather station is 1. 1. of the year 2010 after initial set-up. To set the date:

1. Using the + key, set the year required. The range runs from 2010 to 2039 (default is 2010).
2. Press the SET key to enter the month setting mode.
3. The month digit will be flashing. Press the + key to set the month and then press the SET key to go to the date setting.
4. The date digit will be flashing. Press the + key to set the date.
5. Confirm with the SET key and enter the **"12/24-Hour Display setting"**.

12/24 HOUR TIME DISPLAY SETTING



1. After setting time reception ON/OFF, press the SET key, "12h" or "24h" flashes in the LCD. (default 12 h)
2. Press the + key to select the "12h" or "24h" display mode.
3. Press the SET again to confirm and to enter the **"°F/°C Temperature unit setting"**.

Note: When 24h mode display is selected, the calendar format will be "Day. Month." display. When 12h mode display is selected, the calendar format will be "Month. Day." display.

°F/°C TEMPERATURE UNIT SETTING



The default temperature reading is set to °F (degree Fahrenheit).





To select °C (degree Celsius):





1. The "°C or °F" will be flashing, use the + key to toggle between "°C" and "°F".
2. Once the desired temperature unit has been chosen, confirm with the SET key and exit the setting mode.





WEATHER FORECAST AND TENDENCY:

The weather forecast icons (Weather man):

One of the 15 different weather icons (featured by Weather man with different clothing) is displayed in the centre of LCD, which indicates the different forecast weather conditions (Sunny, Sunny + Cloudy or Cloudy + Rainy) due to change in air pressure level and the current outdoor temperature:

	$\geq 78.8^{\circ}\text{F}$ (26°C)	66.2 to 78.6°F (19 to 25.9°C)	50 to 66°F (10 to 18.9°C)	32 to 49.8°F (0 to 9.9°C)	$< 32^{\circ}\text{F}$ (0°C)
Sunny					

	$\geq 78.8^{\circ}\text{F}$ (26°C)	66.2 to 78.6°F (19 to 25.9°C)	50 to 66°F (10 to 18.9°C)	32 to 49.8°F (0 to 9.9°C)	$< 32^{\circ}\text{F}$ (0°C)
Sunny + Cloudy					

	$\geq 78.8^{\circ}\text{F}$ (26°C)	66.2 to 78.6°F (19 to 25.9°C)	50 to 66°F (10 to 18.9°C)	32 to 49.8°F (0 to 9.9°C)	$< 32^{\circ}\text{F}$ (0°C)
Cloudy + Rainy					

For every sudden or significant change in the air pressure, the weather icons will update accordingly to represent the change in weather. If the icons do not change, then it means either the air pressure has not changed or the change has been too slow for the Weather Projection Station to register. However, if the

icon displayed is a sun or raining cloud, there will be no change of icon if the weather gets any better (with sunny icon) or worse (with rainy icon) since the icons are already at their extremes.

The icons displayed forecasts the weather in terms of getting better or worse and not necessarily sunny or rainy as each icon indicates. For example, if the current weather is cloudy and the rainy icon is displayed, it does not mean that the product is faulty because it is not raining. It simply means that the air pressure has dropped and the weather is expected to get worse but not necessarily rainy.

Note:

After setting up, readings for weather forecasts should be disregarded for the next 12-24 hours. This will allow sufficient time for the Weather station to collect air pressure data at a constant altitude and therefore result in a more accurate forecast.

Common to weather forecasting, absolute accuracy cannot be guaranteed. The weather forecasting feature is estimated to have an accuracy level of about 75% due to the varying areas the Weather station has been designed for use in. In areas that experience sudden changes in weather (for example from sunny to rain), the Weather station will be more accurate compared to use in areas where the weather is stagnant most of the time (for example mostly sunny).

If the Weather station is moved to another location significantly higher or lower than its initial standing point (for example from the ground floor to the upper floors of a house), remove the batteries and re-insert them after about 30 seconds. By doing this, the Weather station will not mistake the new location as being a possible change in air-pressure when really it is due to the slight change of altitude. Again, disregard weather forecasts for the next 12 to 24 hours as this will allow time for operation at a constant altitude.

THE WEATHER TENDENCY INDICATOR

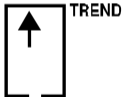

Working together with the weather icons are the weather tendency indicators (the upward and downward arrow located near the Weather man). When the indicator points upwards, it means that the air-pressure is increasing and the weather is expected to improve, but when indicator points downwards, the air-pressure is dropping and the weather is expected to become worse.

Therefore, user may see how the weather has changed and is expected to change. For example, if the indicator is pointing downwards together with cloudy icons, it means that the last noticeable change in the weather was when it was sunny (the sunny icon only). Therefore, the next change in the weather will be the cloudy icons since the indicator is pointing downwards.

Note:

- Once the weather tendency indicator has registered a change in air pressure, it will remain permanently visualized on the LCD.
- When the tendency indicator is pointing to the right, it means that no pressure change has been detected by the weather station from the beginning. Therefore, the coming weather condition is expected to be more or less the same as the current condition.



The coming weather condition is expected to be more or less the same as the current condition

THE COMFORT LEVEL INDICATOR:

The comfort level indicator is located at the right of the weather man icon:

- Comfortable** : A happy face icon “☺” indicating a temperature level between 20°C and 25.9°C (68°F to 78.6°F) and relative humidity reading between 45% and 65%.
- Uncomfortable** : A sad face icon “☹” indicating any value outside the comfortable range.

DISPLAY OF INDOOR TEMPERATURE AND HUMIDITY READING:

The indoor temperature and humidity are measured and displayed on the second section of the LCD.

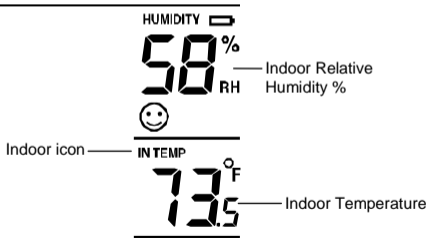

DISPLAY OF OUTDOOR TEMPERATURE READING:

The outdoor temperature is measured and displayed on the first section of the LCD.



DISPLAY OF INDOOR MAXIMUM AND MINIMUM TEMPERATURE RECORDS:

1. In normal display mode, press the IN button once. The min indoor temperature will be shown in the LCD.
2. Then press the IN button one more time, the max indoor temperature will be shown.:

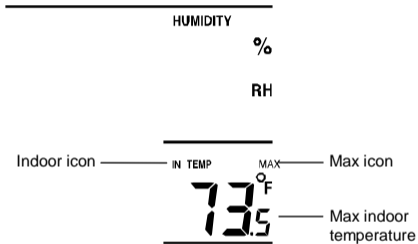

3. Press one more time the IN button to go back to the normal display.

RESETTING THE INDOOR MAXIMUM/ MINIMUM RECORDS

Note: The indoor minimum and maximum records are to be reset at the same time

1. In normal display mode, press the IN key once. The min indoor temperature will be displayed.
2. Then press and hold the IN key for about 3 seconds, this will reset the indoor minimum and maximum temperatures to the current value.

DISPLAY OF OUTDOOR MAXIMUM AND MINIMUM TEMPERATURE RECORDS

1. Press the OUT button once, the min outdoor temperature will be displayed.



2. By pressing OUT button once more, the max outdoor temperature will be shown.
3. Press one more OUT button to advance to normal display.

RESETTING THE OUTDOOR MAXIMUM/ MINIMUM TEMPERATURE RECORDS

Note: The outdoor minimum and maximum records are to be reset at the same time

1. In normal display mode, press the OUT key once. The min outdoor temperature will be displayed.

2. Then press and hold the OUT key for about 3 seconds, this will reset the outdoor minimum and maximum temperatures to the current value.

915 MHz RECEPTION

The Weather station should receive the temperature data within 5 minutes after set-up. If the temperature data is not received 5 minutes after setting up (not successfully continuously, the outdoor display shows “- - -”), please check the following points:

1. The distance of the Weather station or sensor should be at least 1.5 to 2 meters away from any interfering sources such as computer monitors or TV sets.
2. Avoid positioning the Weather station onto or in the immediate proximity of metal window frames.
3. Using other electrical products such as headphones or speakers operating on the same signal frequency (915MHz) may prevent correct signal transmission and reception.
4. Neighbours using electrical devices operating on the 915MHz signal frequency can also cause interference.

Note:

When the 915MHz signal is received correctly, do not re-open the battery cover of either the sensor or Weather station, as the batteries may spring free from the contacts and force a false reset. Should this

happen accidentally then reset all units (see **Setting up** above) otherwise transmission problems may occur.

The transmission range is about 100 m from the sensor to the Weather station (in open space). However, this depends on the surrounding environment and interference levels. If no reception is possible despite the observation of these factors, all system units have to be reset (see **Setting up**).

MOUNTING

POSITIONING THE WEATHER STATION:

The Weather Station may be hung onto wall easily or free standing.

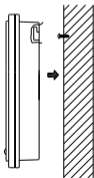

To wall mount

Choose a sheltered place. Avoid direct rain and sunshine. Before wall mounting, please check that the outdoor temperature values can be received from the desired locations.

1. Fix a screw (not supplied) into the desired wall, leaving the head extended out the by about 5mm.
2. Remove the stand from the Weather Station by pulling it away from the base and hang the station onto the screw. Remember to ensure that it locks into place before releasing.

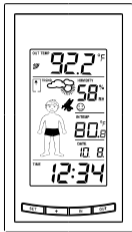

Free standing

With the foldout stand, the weather station can be placed onto any flat surface.

POSITIONING THE TEMPERATURE SENSOR

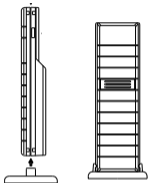

The Sensor is supplied with a holder that may be attached to a wall with the two screws supplied. The Sensor can also be position on a flat surface by securing the stand to the bottom to the Sensor.

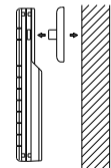

To wall mount:

1. Secure the bracket onto a desired wall using the screws and plastic anchors.
2. Clip the remote temperature sensor onto the bracket.

Note:

Before permanently fixing the sensor wall base, place all units in the desired locations to check that the outdoor temperature reading is receivable. In event that the signal is not received, relocate the sensors or move them slightly as this may help the signal reception.

CARE AND MAINTENANCE:

- Extreme temperatures, vibration and shock should be avoided as these may cause damage to the unit and give inaccurate forecasts and readings.
- Precautions shall be taken when handling the batteries. Injuries, burns, or property damage may be resulted if the batteries are in contact with conducting materials, heat, corrosive materials or explosives. The batteries shall be taken out from the unit before the product is to be stored for a long period of time.
- Immediately remove all low powered batteries to avoid leakage and damage. Replace only with new batteries of the recommended type.
- When cleaning the display and casings, use a soft damp cloth only. Do not use solvents or scouring agents as they may mark the LCD and casings.
- Do not submerge the unit in water. Furthermore, fix all parts in place where the units are adequately protected against moisture and rain.

- Special care shall be taken when handling a damaged LCD display. The liquid crystals can be harmful to user's health.
- Do not make any repair attempts to the unit. Return them to their original point of purchase for repair by a qualified engineer. Opening and tampering with the unit may invalidate their guarantee.
- Never touch the exposed electronic circuit of the device as there is a danger of electric shock should it become exposed.
- Do not expose the units to extreme and sudden temperature changes, this may lead to rapid changes in forecasts and readings and thereby reduce their accuracy.

SPECIFICATIONS:

Temperature measuring range:

Indoor : 14.1°F to +139.8°F with 0.2°F resolution (-9.9°C to +59.9°C with 0.1°C resolution);
“OF.L” displayed if outside this range

Outdoor : -39.8°F to +139.8°F with 0.2°F resolution (-39.9°C to +59.9°C with 0.1°C resolution);
“OF.L” displayed if outside this range

Indoor relative humidity measuring range : 20% to 95% with 1% resolution (displays “- -” when the measured humidity is outside the range or when the indoor temperature reading is “OF.L”)

Indoor temperature checking interval : every 16 seconds

Indoor humidity checking interval : every 64 seconds

Outdoor data reception : every 4 seconds

Power supply:

Weather station : 2 x AA, IEC, LR6, 1.5V

Temperature sensor : 2 x AA, IEC, LR6, 1.5V

Battery life cycle (Alkaline batteries recommended)

Weather station : Approximately 24 months

Temperature sensor : Approximately 24 months

Dimensions (L x W x H)

Weather station : 3.18" x 1.22" x 5.64" (80.8 x 30.9 x 143.2 mm)

Temperature sensor : 1.50" x 0.83" x 5.05" (38.2 x 21.2 x 128.3 mm)

WARRANTY INFORMATION

La Crosse Technology, Ltd provides a 1-year limited warranty on this product against manufacturing defects in materials and workmanship.

This limited warranty begins on the original date of purchase, is valid only on products purchased and used in North America and only to the original purchaser of this product. To receive warranty service, the purchaser must contact La Crosse Technology, Ltd for problem determination and service procedures. Warranty service can only be performed by a La Crosse Technology, Ltd authorized service center. The original dated bill of sale must be presented upon request as proof of purchase to La Crosse Technology, Ltd or La Crosse Technology, Ltd's authorized service center.

La Crosse Technology, Ltd will repair or replace this product, at our option and at no charge as stipulated herein, with new or reconditioned parts or products if found to be defective during the limited warranty period specified above. All replaced parts and products become the property of La Crosse Technology, Ltd and must be returned to La Crosse Technology, Ltd.

Replacement parts and products assume the remaining original warranty, or ninety (90) days, whichever is longer. La Crosse Technology, Ltd will pay all expenses for labor and materials for all repairs covered

by this warranty. If necessary repairs are not covered by this warranty, or if a product is examined which is not in need or repair, you will be charged for the repairs or examination.

The owner must pay any shipping charges incurred in getting your La Crosse Technology, Ltd product to a La Crosse Technology, Ltd authorized service center.

Your La Crosse Technology, Ltd warranty covers all defects in material and workmanship with the following specified exceptions: (1) damage caused by accident, unreasonable use or neglect (including the lack of reasonable and necessary maintenance); (2) damage occurring during shipment (claims must be presented to the carrier); (3) damage to, or deterioration of, any accessory or decorative surface; (4) damage resulting from failure to follow instructions contained in your owner's manual; (5) damage resulting from the performance of repairs or alterations by someone other than an authorized La Crosse Technology, Ltd authorized service center; (6) units used for other than home use (7) applications and uses that this product was not intended or (8) the products inability to receive a signal due to any source of interference.

This warranty covers only actual defects within the product itself, and does not cover the cost of installation or removal from a fixed installation, normal set-up or adjustments, claims based on

misrepresentation by the seller or performance variations resulting from installation-related circumstances.

LA CROSSE TECHNOLOGY, LTD WILL NOT ASSUME LIABILITY FOR INCIDENTAL, CONSEQUENTIAL, PUNITIVE, OR OTHER SIMILAR DAMAGES ASSOCIATED WITH THE OPERATION OR MALFUNCTION OF THIS PRODUCT. THIS PRODUCT IS NOT TO BE USED FOR MEDICAL PURPOSES OR FOR PUBLIC INFORMATION. THIS PRODUCT IS NOT A TOY. KEEP OUT OF CHILDREN'S REACH.

This warranty gives you specific legal rights. You may also have other rights specific to your State. Some States do not allow the exclusion of consequential or incidental damages therefore the above exclusion of limitation may not apply to you.

For warranty work, technical support, or information contact:

La Crosse Technology, Ltd
2817 Losey Blvd. S.
La Crosse, WI 54601

On the Web: www.lacrossetechnology.com/9630

All rights reserved. This handbook must not be reproduced in any form, even in excerpts, or duplicated or processed using electronic, mechanical or chemical procedures without written permission of the publisher. This handbook may contain mistakes and printing errors. The information in this handbook is regularly checked and corrections made in the next issue. We accept no liability for technical mistakes or printing errors, or their consequences.
All trademarks and patents are acknowledged.