

WS-7014U-IT
Wireless 915 MHz
Radio-controlled Weather Station

Instruction Manual

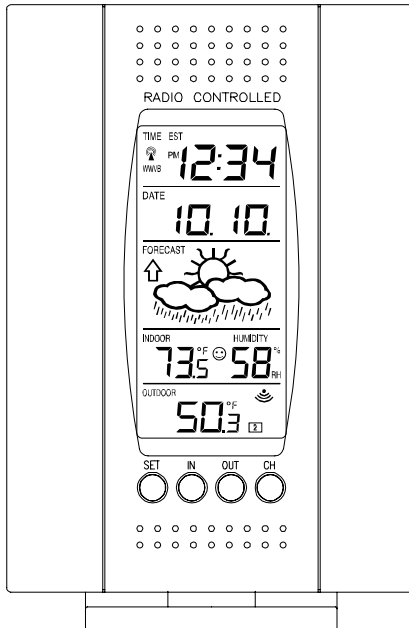

Tomorrow's Weather Today™

TABLE OF CONTENTS

Topic	Page
Inventory of Contents/Additional Equipment	3
About WWVB	3
Quick Set-Up Guide	4
Detailed Set-Up Guide	
Battery installation	5
<i>Program Mode</i>	
Program Sequence and Default Settings	6
Function Keys	6
Setting the LCD Contrast	7
Setting the Time Zone	7-8
Daylight Saving Time Setting	8
Radio-controlled Time Setting	9
12/24-hour Time Setting	9
Setting the Time	10-11
Setting the Year, Day and Month	11
Setting the Snooze	12
Setting the Temperature Format	12
Setting the Forecast Sensitivity	13
Features	
Weather Forecast Icons and Tendency Arrows	14-15
Indoor Temperature, Humidity, & Comfort Level Indicator	15-16
Outdoor Temperatures	16
Minimum & Maximum Records (Indoor, Outdoor, & Resetting)	16-17
Additional Remote Control Sending Units (Set-Up, Viewing, & Operation)	18-19
Mounting	19-21
Troubleshooting	22-23
Maintenance & Care	23
Specifications	24
Warranty Information	25-26

This product offers:



INSTANT TRANSMISSION is the state-of-the-art new wireless transmission technology, exclusively designed and developed by LA CROSSE TECHNOLOGY. *INSTANT TRANSMISSION* offers you an immediate update (every 4 seconds!) of all your outdoor data measured from the transmitters: follow your climatic variations in real-time!

INVENTORY OF CONTENTS

1. The Wireless Weather Station/ (Figure 1).
2. One remote temperature sensor with mounting bracket (Figure 2).
3. Three each, ½" Philips screws.
4. One strip double-sided adhesive tape.
5. Instruction manual and warranty card.

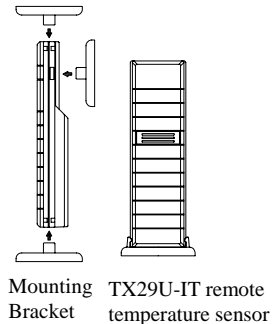
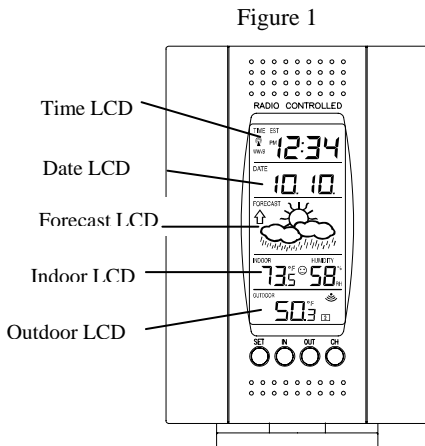

Figure 2

ADDITIONAL EQUIPMENT (not included)

1. Two fresh AA 1.5V Alkaline batteries for the Wireless Weather Station.
2. Two fresh AA 1.5V Alkaline batteries for the remote temperature sensor.
3. One, Philips screwdriver for mounting.

ABOUT WWVB (Radio Controlled Time)

The NIST (National Institute of Standards and Technology—Time and Frequency Division) WWVB radio station is located in Ft. Collins, Colorado, and transmits the exact time and date

signal continuously throughout the United States at 60 kHz. The signal can be received up to 2,000 miles away through the internal antenna in the Weather Station. However, due to the nature of the Earth's Ionosphere, reception is very limited during daylight hours. The Weather Station will search for a signal every night when reception is best. The WWVB radio station derives its signal from the NIST Atomic clock in Boulder, Colorado. A team of atomic physicists is continually measuring every second, of every day, to an accuracy of ten billionths of a second per day. These physicists have created an international standard, measuring a second as 9,192,631,770 vibrations of a Cesium-133 atom in a vacuum. For more information on the atomic clock and WWVB please see the NIST website at <http://www.boulder.nist.gov/timefreq/stations/wwvb.htm>.

QUICK SET-UP GUIDE

Hint: Use good quality Alkaline Batteries and avoid rechargeable batteries.

1. Have the Wireless Weather Station and remote temperature sensor 3 to 5 feet apart.
2. Batteries should be out of both units for 10 minutes.
3. Place the batteries into the **remote temperature sensor** first then into the indoor weather station.
(All remote temperature sensors must be started before the Wireless Weather Station)
4. **DO NOT PRESS ANY BUTTONS FOR 15 MINUTES.**

In this time the Wireless Weather Station and remote temperature sensor will start to talk to each other and the display will show both the indoor temperature and humidity, and an outdoor temperature. If the Wireless Weather Station does not display both temperatures after the 15 minutes please retry the set up as stated above. After both indoor and outdoor temperatures are displayed for 15 minutes you can place your remote temperature sensor outdoor and set your time.

The remote temperature sensor should be placed in a dry, shaded area. The temperature sensor has a range of 330 feet. Keep in mind that the 330 feet is in open air with no obstructions and that radio waves **DO NOT** curve around objects. Actual transmission range will vary depending on what is in the path of the signal. Each obstruction (roof, walls, floors, ceilings, thick trees, etc.) will effectively cut signal range in half.

Example: A Wireless Weather Station with a 330 foot range is mounted on an interior wall, so that the signal has to pass through one interior wall, one exterior wall, and across the 10 feet width of the room between the 2 walls. The first wall will reduce the range to 165 feet, and the second wall will reduce the range to 87 feet. Factoring in the 10 foot room, this leaves a maximum of 77 feet of remaining signal range.

This allowance is typically enough for a frame wall with non-metallic siding; however certain materials can reduce range even further. Metal siding, stucco, and some types of glass can reduce signal range by as much as $\frac{3}{4}$ or more, compared to the $\frac{1}{2}$ reduction typical of most obstructions. It is possible to receive a signal through these materials, however maximum range will be much less due to their tendency to absorb or reflect a much larger portion of the sensor's signal.

To complete the set up of your Wireless Weather Station after the 15 minutes have passed please follow the steps that follow in the Detailed Set-Up Guide.

DETAILED SET-UP GUIDE

I. BATTERY INSTALLATION (When one temperature sensor is being used)

1. First, insert the batteries to the temperature sensor (see “**A. Remote Temperature Sensor**” below).
2. Within 2 minutes of powering up the sensor, insert the batteries to the Weather Station (see “**B. Wireless Weather Station**” below). Once the batteries are in place, all segments of the LCD will light up briefly. Following the indoor temperature and humidity, and the time as 12:00 will be displayed. If they are not shown in LCD after 60 seconds, remove the batteries and wait for at least 60 seconds before reinserting them. Once the indoor data is displayed user may proceed to the next step.
3. After the batteries are inserted, the Weather Station will start receiving data signal from the sensor. The outdoor temperature should then be displayed on the Weather Station. If this does not happen after 2 minutes, the batteries will need to be removed from both units and reset from step 1 and the signal reception icon is no longer shown.

A. REMOTE TEMPERATURE SENSOR

1. Remove the mounting bracket. The bracket snaps on and off easily.
2. Remove the battery cover, by sliding the cover down.
3. Observing the correct polarity install 2 AA batteries. The batteries will fit tightly (to avoid start-up problems make sure they do not spring free).
4. Replace the battery cover by sliding upwards. Be sure battery cover is on securely.

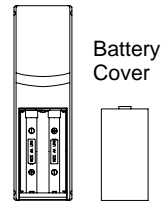

B. WIRELESS WEATHER STATION

1. Remove the battery cover. To do this, insert a solid object in the space provided at the lower-central position of the battery cover, then push up and pull out on the battery cover.
2. Observe the correct polarity, and install 2 AA batteries.
3. Replace the battery cover.

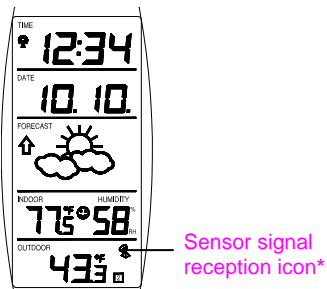
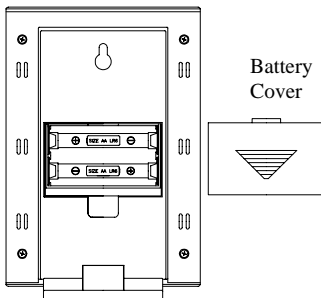

* When the signal is successfully received by the Weather Station, the icon will be switched on. (If not successful, the icon will not be shown in LCD) So the user can easily see whether the last reception was successful (icon on) or not (icon off). On the other hand, the short blinking of the icon shows that a reception is being done now.

- If the signal reception is not successful on the first frequency (915MHz) for 45 seconds, the frequency is changed to 920MHz and the learning is tried another 45 seconds. If still not successful the reception is tried for 45 seconds on 910MHz. This will also be done for re-synchronization.

PROGRAM MODE

Programming Note: If 30 seconds is allowed to pass, or the CH button is pressed during the programming mode, the unit will confirm/set the last information entered—the display will stop flashing and return to normal time-date readings. If you don't leave the program mode during the programming of sections IV through XI, you can advance to step 4 of the next program setting. If you do leave the program setting (or want to program a specific setting) follow each instructional step to program that setting.

I. PROGRAMMING SEQUENCE AND DEFAULT SETTINGS

The programming sequence and default (factory) settings are as follows:

LCD Contrast	5
Time Zone	-5 (Eastern)
Daylight Saving Time	1 (on)
Radio-controlled time reception	ON
12/24-hour time	12
Time	12:00
Year	2006
Day and Month	1.1.
Snooze (this function not used)	10
Temperature Format	°F
Forecast Sensitivity	2

Please note that while there is a snooze adjustment in the programming this is an unused function as there is no alarm on the indoor weather station.

II. FUNCTION KEYS

The function keys are located on the front of the unit directly below the LCD.

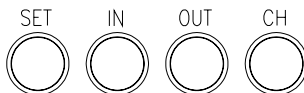

III. SETTING THE LCD CONTRAST

1. Press and hold the *SET* button for 5 seconds.
2. "LCD" will show in the time LCD and the number setting will flash.



Note: There are 8 LCD contrast levels to choose from—"Lcd 0" is the lightest, and "Lcd 7" is the darkest.

3. Press and release the *IN* button to select the level you desire.
4. Press and release the *SET* button to confirm and advance to the Time Zone setting.

IV. TIME ZONE SETTING

1. Press and hold the *SET* button for 5 seconds.
2. "LCD" will show in the time LCD and the number setting will flash.
3. Press and release the *SET* button again.
4. The time zone will flash in the date LCD.

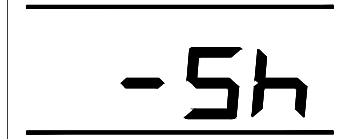

5. Press and release the *IN* button to select your time zone.

Note: When a time zone for the U.S. is selected the corresponding abbreviation will appear above the time (please see the table on the next page). It is possible to select any time zone from -12 GMT to +12 GMT (for example to see the time in another country)

TIME ZONES

	GMT	0
	Atlantic	-4
EST;	Eastern	-5
CST;	Central	-6
MST;	Mountain	-7
PST;	Pacific	-8
ALA;	Alaska	-9
HAW;	Hawaii	-10

6. Press and release the *SET* button to confirm and advance to the Daylight Saving Time setting.

V. DAYLIGHT SAVING TIME (DST) SETTING

1. Press and hold the *SET* button for 5 seconds.
2. "LCD" will show in the time LCD and the number setting will flash.
3. Press and release the *SET* button twice.
4. "DST" will appear in the date LCD and either "1" or "0" will flash.



5. Press and release the *IN* button to select DST on or off.

“DST 0” indicates that the feature is off and the WWVB will not change times automatically. “DST 1” indicates that the feature is on and the WWVB will change times automatically.

Note: Some locations (Arizona and parts of Indiana) do not follow Daylight Saving Time, and should select “DST 0.”

6. Press and release the *SET* button to confirm and advance to the radio-controlled time on/off setting.

VI. RADIO-CONTROLLED TIME ON/OFF SETTING

1. Press and hold the *SET* button for 5 seconds.
2. “LCD” will show in the time LCD and the number setting will flash.
3. Press and release the *SET* button three times.
4. “RCC” will appear in the date LCD and “ON” or “OFF” will flash in the time LCD.
5. Press and release the *IN* button to select radio-controlled time on or off.
6. Press and release the *SET* button to confirm and advance to the 12/24-hour time setting.

VII. 12 OR 24 HOUR TIME SETTING

1. Press and hold the *SET* button for 5 seconds.
2. “LCD” will show in the time LCD and the number setting will flash.
3. Press and release the *SET* button four times.
4. “12h” or “24h” will flash in the time LCD.



5. Press and release the *IN* button to select 12 or 24-hour time format.

Note: When in the 12-hour format “P.M.” will appear to the left of the hour in the time LCD between the hours of noon and midnight.

6. Press and release the *SET* button to confirm and advance to the time setting.

VIII. TIME SETTING

There are two methods by which the time and date can be set:

- A) Automatically via WWVB reception, or
- B) Manually.

A. WWVB (Remote Control Time)

This method requires you to do nothing, except wait for the signal to be received, and to select a time zone. Reception usually takes approximately 10 minutes during optimal conditions. The best condition for reception is at night, between midnight and 6:00 am—when there is less atmospheric interference. To keep your time as accurate as possible, Wireless Weather Station

conducts a WWVB search every night between these hours, and overrides any manually set time. The WWVB tower icon (appearing in the TIME LCD) will flash when a signal-search is in progress and a signal is being received, and will remain steady when the signal has been received. If the WWVB time has not been received after 10 minutes of battery installation, you may manually set the time or leave the time function alone (reception will occur regardless). After a successful reception, no more reception attempt would be made until the following day.

B. MANUAL TIME SETTING

Note: When in the 12-hour format “P.M.” will appear to the left of the hour in the time LCD between the hours of noon and midnight.

1. Press and hold the *SET* button for 5 seconds.
2. “LCD” will show in the time LCD and the number setting will flash.
3. Press and release the *SET* button five times.
4. The time will flash in the time LCD.



5. Press and release the *IN* button to advance the hours.
6. Press and release the *OUT* button to advance the minutes.
7. Press and release the *SET* button to confirm and advance to the year setting.

IX. SETTING THE YEAR, DAY AND MONTH

Note: Reception of the WWVB signal will also set the date and day. The reception of the signal will override any programmed date and day.

1. Press and hold the *SET* button for 5 seconds.
2. “LCD” will show in the time LCD and the number setting will flash.
3. Press and release the *SET* button six times.
4. The year will flash in the date LCD.
5. Press and release the *IN* button to advance the year.
6. Press and release the *SET* button to confirm and advance to the day/month setting.
7. The day and month will flash in the date LCD.



8. Press and release the *IN* button to advance the day.
9. Press and release the *OUT* button to advance the month.
10. Press and release the *SET* button to confirm and advance to the snooze setting.

X. SETTING THE SNOOZE

Note: This is an unused function of the Wireless Weather Station and should be disregarded. The setting has no bearing on the operation. Please press and release the *SET* button to advance to select the temperature format.

XI. SELECTING °F OR °C

1. Press and hold the *SET* button for 5 seconds.
2. "LCD" will show in the time LCD and the number setting will flash.
3. Press and release the *SET* button nine times.
4. Either "°F" or "°C" will flash in the time LCD.



5. Press and release the *IN* button to select the temperature format.
6. Press and release the *SET* button to confirm and advance to the forecast sensitivity setting.

XII. SETTING THE FORECAST SENSITIVITY

Note: The forecast sensitivity can be adjusted to allow for areas that have a higher or lower sensitivity to changing air pressure (for example coastal areas have more pressure change than areas such as southern Arizona).

The numbers correspond to the amount of air pressure change necessary to trigger a change in the forecast icon. Areas that tend to have more air pressure change would set the sensitivity to 3, while areas that experience lower than normal air pressure change would set the sensitivity to 1.

1. Press and hold the *SET* button for 5 seconds.
2. "LCD" will show in the time LCD and the number setting will flash.
3. Press and release the *SET* button ten times.
4. Either "1", "2" or "3" will flash in the time LCD.

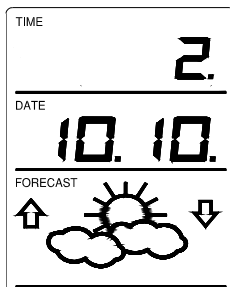

5. Press and release the *IN* button to select the forecast sensitivity
6. Press and release the *SET* button to confirm the forecast sensitivity and complete the programming.

FEATURES OF THE WS-7014U-IT

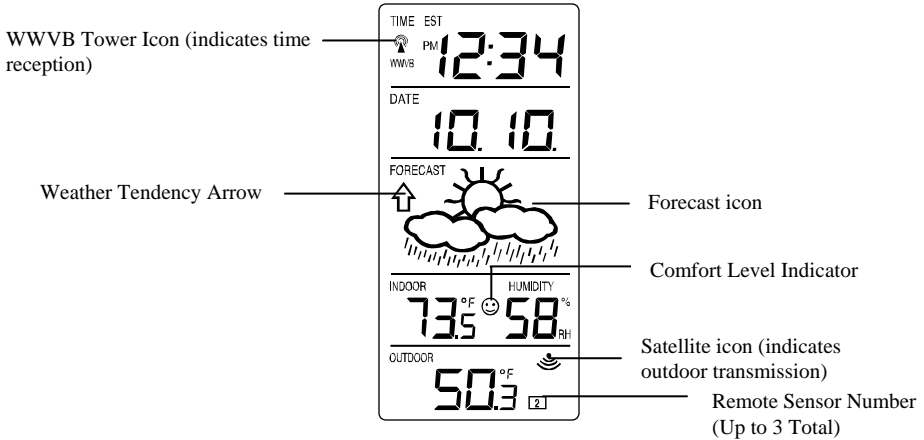

I. WEATHER FORECAST

The weather forecasting feature is estimated to be 75% accurate and is for the next 12 to 24 hours. The weather forecast is based solely upon the change of air pressure over time. The WS-7014U-IT averages past air-pressure readings to provide an accurate forecast—creating a necessity to disregard all weather forecasting for 12-24 hours after the unit has been set-up, reset, or moved from one altitude to another (i.e. from one floor of a building to another floor). In areas where the weather is not largely affected by the change of air pressure, the sensitivity setting should be set to 1.

A. WEATHER ICONS

There are 3 possible weather icons that will be displayed in the FORECAST LCD:

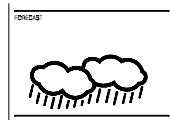
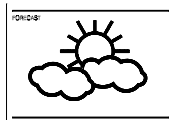
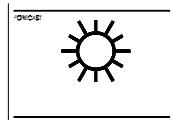

Sunny—indicates that the weather is expected to improve (not that the weather will be sunny).

Sun with Clouds—indicates that the weather is expected to be fair (not that the weather will be sunny with clouds).

Clouds with Rain—indicates that the weather is expected to get worse (not that the weather will be rainy).

These icons indicate the expected weather change in the next 12 to 24 hours. The icon does not give an exact prediction of the weather, however it

should be viewed as a generalization of the expected weather change (for example a “sunny” icon indicates the weather is expected to improve).

The weather icons change when the unit detects a change in air pressure. The icons change in order, from “sunny” to “partly sunny” to “cloudy” or the reverse. It will not change from “sunny” directly to “rainy”, although it is possible for the change to occur quickly. If the symbols do not change then the weather has not changed, or the change has been slow and gradual.

B. WEATHER TENDENCY ARROWS

Other possible displays in the FORECAST LCD are 2 weather tendency arrows, one that points up (on the left side of the LCD) and one that points down (on the right side of the LCD). These arrows reflect current changes in the air pressure. An arrow pointing up indicates that the air pressure is increasing and the weather is expected to improve or remain good, an arrow pointing down indicates that the air pressure is decreasing and the weather is expected to become worse or remain poor. No arrow means the pressure is stable.

II. INDOOR TEMPERATURE, HUMIDITY, AND COMFORT LEVEL INDICATOR

The current indoor temperature (viewed on the left) and relative humidity (viewed on the right) are displayed in the INDOOR LCD. The comfort level indicator is located at the center of the INDOOR LCD. The indicator will display a happy face icon when the temperature is between 68°F and 79°F (20°C and 25.9°C), and the humidity is between 45% and 65%. A sad face icon will be displayed when the temperature and humidity are outside the mentioned ranges.

III. OUTDOOR TEMPERATURE

The temperature received from the remote temperature sensor is viewed in the OUTDOOR LCD. When there is more than one remote temperature sensor unit in operation, a “boxed” number will appear to the right of the temperature. This indicates which remote temperature sensor unit (1, 2, or 3) is currently displaying its data in the OUTDOOR LCD. (This feature is explained in further detail in section *V—Adding Remote Temperature Sensors*).

IV. MINIMUM AND MAXIMUM TEMPERATURE RECORDS

The WS-7014U-IT keeps a record of the MINIMUM and MAXIMUM temperature, and the time and date of their occurrence—for both the indoor and outdoor modes.

A. VIEWING THE INDOOR TEMPERATURE RECORDS

1. Press the *IN* button once. “MIN” appears above the indoor temperature and the LCD will flash, indicating that the minimum temperature (along with the humidity measured at that time) and the time and date of occurrence are displayed. The minimum records will display for 30 seconds before returning to the normal display mode.

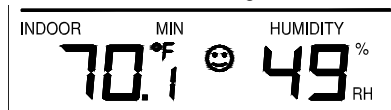

2. Press the *IN* button again (once while "MIN" is still displayed, twice otherwise). "MAX" appears above the indoor temperature and the LCD will flash, indicating that the maximum temperature (along with the humidity measured at that time) and the time and date of occurrence are displayed.
3. While "MAX" is still displayed press the *IN* button again to return to the current data display. Or you can wait 30 seconds, during either the minimum or the maximum readings, and the unit will automatically return to current data readings.

B. VIEWING THE OUTDOOR TEMPERATURE RECORDS

1. Press the *OUT* button once. "MIN" appears above the outdoor temperature and the LCD will flash, indicating that the minimum temperature, and the time and date of occurrence are displayed. The minimum records will display for 30 seconds before returning to the normal display mode.
2. Press the *OUT* button again (once while "MIN" is still displayed, twice otherwise). "MAX" appears above the outdoor temperature and the LCD will flash, indicating that the maximum temperature and the time and date of occurrence are displayed.

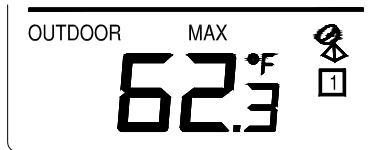

3. While "MAX" is still displayed press the *OUT* button again to return to the current data display. Or you can wait 30 seconds, during either the minimum or the maximum readings, and the unit will automatically return to current data readings.

C. RESETTING THE MINIMUM AND MAXIMUM RECORDS

1. All the Indoor records (minimum and maximum) will be reset after the *IN* button is pressed and held for 5 seconds.
2. All the Outdoor records (minimum and maximum) will be reset after the *OUT* button is pressed and held for 5 seconds.

V. ADDING REMOTE TEMPERATURE SENSORS (OPTIONAL)

The WS-7014U-IT is able to receive signals from 2 additional temperature sensors. The following are instructions for the set-up of temperature sensor units with the WS-7014U-IT. These extra sensors can be purchased through the same dealer as this unit.

1. Remove all the batteries from the receiver and sensor(s) and wait 60 seconds. During these 60 seconds, press any button 20 times to discharge any excess power.
2. Insert the batteries to the first temperature sensor.
3. Within 2 minutes of powering up the first sensor, insert the batteries to the Weather Station. Once the batteries are in place, all segments of the LCD will light up briefly. Following the indoor/outdoor temperature and indoor humidity, time as 12:00, calendar, weather icons will be displayed. If they are not shown in

LCD after 60 seconds, remove the batteries and wait for at least 60 seconds before reinserting them.

4. The outdoor temperature from the first sensor (channel 1) should then be displayed on the Weather station. If this does not happen and the signal reception icon is not shown, after 2 minutes, the batteries will need to be removed from both units and reset from step 1.
5. Insert the batteries to the second sensor as soon as the outdoor temperature readings from the first sensor are displayed on the Weather station.
NOTE: You must insert the batteries into the second sensor within 45 seconds of reception of the first sensor.
6. The outdoor temperature from the second sensor and the "channel 2" icon should then be displayed on the Weather Station. If this does not happen after 2 minute, the batteries will need to be removed from all the units and reset from step 1.
7. Insert the batteries to the third sensor as soon as the "channel 2" icon and outdoor data are displayed on the Weather Station. Then within 2 minutes, the channel 3 outdoor data from the third sensor will be displayed and the channel icon will shift back to "1" once the third sensor is successfully received. If this is not happen, user shall restart the setting up from step 1.
NOTE: You must insert the batteries into the third sensor within 45 seconds of reception of the second sensor.

IMPORTANT: Transmission problems will arise if the setting for multiple sensors is not followed as described above. Should transmission problems occur, it is necessary to remove the batteries from all units and start again the set-up from step 1.

VI. VIEWING AND OPERATING WITH MULTIPLE REMOTE TEMPERATURE SENSOR UNITS

1. To view the temperature of a different remote temperature sensor unit, press and release the *CH* button. A shift from one "boxed" number to the next should be observed in the OUTDOOR LCD.
2. To view the Minimum/Maximum temperature: first select which remote temperature sensor to read data from (indicated by the "boxed" number), then press the *OUT* button. Pressing this button once will display the minimum temperature, and the date and time the data was recorded. Pressing this button a second time (while "MIN" is still displayed, otherwise press the button twice) will display the same data for the maximum recordings.
6. To reset the Minimum/Maximum readings, it is necessary to select which remote temperature sensor you wish to reset. Press and hold the *OUT* button for 5 seconds, the records for the selected remote temperature sensor unit will be reset.

MOUNTING

Note: Before permanently mounting ensure that the Wireless Weather Station is able to receive WWVB signals from the desired location. Also, extreme and sudden changes in temperature will decrease the accuracy of the Wireless Weather Station, and changes in elevation will result with inaccurate weather forecasting for the next 12 to 24 hours. These changes will require a 12 to 24 hour wait before obtaining reliable data. To achieve a true temperature reading, avoid mounting where direct sunlight can

reach the remote temperature sensor or Wireless Weather Station. While the remote temperature sensor is weather proof, avoid submersion in water or snow. We recommend that you mount the remote temperature sensor on an outside North-facing wall. The sending range is 330ft—obstacles such as walls, concrete, and large metal objects can reduce the range. Place both units in their desired location, and wait approximately 15 minutes before permanently mounting to ensure that there is proper reception. The Wireless Weather Station should display a temperature in the OUTDOOR LCD within 4 minutes of setting up.

I. THE REMOTE TEMPERATURE SENSOR

The remote temperature sensor can be mounted in two ways:

- with the use of screws, or
- using the adhesive tape.

A. MOUNTING WITH SCREWS

- 1) Remove the mounting bracket from the remote temperature sensor.
- 2) Place the mounting bracket over the desired location.
- 3) Through the three screw holes of the bracket, mark the mounting surface with a pencil.
- 4) Screw mounting bracket onto the mounting surface. Ensure that the screws are flush with the bracket.
- 5) Insert the remote temperature sensor into the bracket.

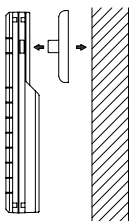
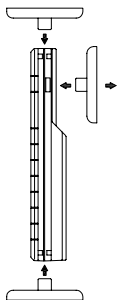

B. MOUNTING WITH ADHESIVE TAPE

- 1) With a nonabrasive solution, clean and dry the back of the mounting bracket and the mounting surface to ensure a secure hold. The mounting surface should be smooth and flat.
- 2) Remove the protective strip from one side of the tape.
- 3) Adhere the tape to the designated area on the back of the mounting bracket.
- 4) Remove the protective strip from the other side of the tape.
- 5) Position the remote temperature sensor in the desired location, ensuring that the Wireless Weather Station can receive the signal.

Note: Mounting with adhesive tape is not recommended as a permanent mounting solution. Only use the adhesive tape during set-up process.

II. THE WIRELESS WEATHER STATION

The Wireless Weather Station can be mounted in two ways:
with the table stand or,
on the wall with the use of a wall hanging screw (not included).

A. USING THE TABLE STAND

The Wireless Weather Station comes with the table stand already mounted. If you wish to use the table-stand all that is required is to place the Wireless Weather Station in an appropriate location.

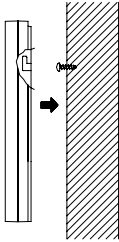

B. WALL MOUNTING

- 1) Remove the table-stand. To do this, pull down on the stand from the rear and rotate forward.
- 2) Fix a screw (not included) into the desired wall, leaving approximately 3/16 of an inch (5mm) extended from the wall.
- 3) Place the Wireless Weather Station onto the screw using the hanging hole on the backside.
- 4) Gently pull the Wireless Weather Station down to lock the screw into place.

TROUBLESHOOTING

NOTE: For problems not solved, please contact La Crosse Technology.

Problem: No reception of WWVB time signal.

- Solution:**
- 1) Wait overnight for signal.
 - 2) Be sure Weather Station is at least 6 feet from any electrical devices, such as televisions, computers, or other radio-controlled clocks.
 - 3) Remove batteries for five minutes, reinsert and leave the unit alone overnight without pressing buttons.
 - 4) If there are still problems, contact La Crosse Technology

Problem: Hour is incorrect (minute and date are correct)

Solution: Be sure correct time zone and daylight saving time settings are selected.

Problem: The LCD is faint

- Solution:**
- 1) Set the LCD contrast to a higher number
 - 2) Replace batteries

Problem: No outdoor temperature is displayed.

- Solution:**
- 1) Remove all batteries, reinsert into sender first, then display.
 - 2) Place remote sender closer to display.
 - 3) Be sure all batteries are fresh.
 - 4) Place Remote Control Sender and Weather Station in position so the straight-line signal is not passing through more than two or three walls.

Problem: Temperatures do not match if units are placed next to each other.

Solution: Each temperature sensor is manufactured to be accurate to within 1 degree plus or minus and under normal conditions, so two sensors could be as much as 2 degrees different. However, the difference can be exaggerated further because the sensors are designed for different working environments. The indoor sensor is less responsive to ambient air currents because of the shielding effect of the display's case. In addition, the case can act as a heat sink to absorb and store heat from external sources (i.e. handling of the case or radiant heat). Also, the much greater range of the outdoor temperature sensor requires a different calibration curve than the indoor range. Error is usually greater at the extreme ends of a range, making it

harder to compare different ranges with different curves. Under non-laboratory conditions, it is difficult to compensate for the above factors and obtain an accurate comparison.

MAINTENANCE AND CARE INSTRUCTIONS

- Extreme temperatures, vibration, and shock should be avoided to prevent damage to the units.
- Clean displays and units with a soft, damp cloth. Do not use solvents or scouring agents; they may mark the displays and casings.
- Do not submerge in water.
- Immediately remove all low powered batteries to avoid leakage and damage.
- Opening the casings invalidates the warranty. Do not try to repair the unit. Contact La Crosse Technology for repairs.

SPECIFICATIONS

Temperature measuring range:	
Indoor:	14.1°F to 139.8°F with 0.2°F resolution. (-9.9°C to 59.8°C with 0.1°C resolution) "OFL" displayed if outside this range.
Outdoor:	-39.8 °F to 139.8°F with 0.2°F resolution. (-39.8°C to 59.8°C with 0.1°C resolution). "OFL" displayed if outside this range.
Indoor relative humidity measuring range:	1% to 99% with 1% resolution. ("-" displayed if outside this range.
Indoor Temperature checking interval:	Every 10 seconds.
Indoor Humidity checking interval:	Every 15 seconds.
Outdoor Temperature checking interval (Remote Temperature Sensor):	Every 4 seconds
Outdoor Temperature reception (Weather Station):	Every 4 seconds.
Transmission Range:	330 feet (in open space).
Power Supply:	
Weather Station:	2 x AA, IEC LR6, 1.5V.
Remote Temperature Sensor:	2 x AA, IEC LR6, 1.5V.
Battery life cycle:	Approximately 24 months.
Recommended battery type:	Alkaline.
Dimensions (L x W x H)	
Weather Station (without stand):	3.54 x 1.18 x 5.43 in (90 x 30 x 138mm).
Remote Temperature Sensor:	5.05 x 1.50 x 0.83 in. (128.3 x 38.2 x 21.2 mm)

WARRANTY INFORMATION

La Crosse Technology, Ltd provides a 1-year limited warranty on this product against manufacturing defects in materials and workmanship.

This limited warranty begins on the original date of purchase, is valid only on products purchased and used in North America and only to the original purchaser of this product. To receive warranty service, the purchaser must contact La Crosse Technology, Ltd for problem

determination and service procedures. Warranty service can only be performed by a La Crosse Technology, Ltd authorized service center. The original dated bill of sale must be presented upon request as proof of purchase to La Crosse Technology, Ltd or La Crosse Technology, Ltd's authorized service center.

La Crosse Technology, Ltd will repair or replace this product, at our option and at no charge as stipulated herein, with new or reconditioned parts or products if found to be defective during the limited warranty period specified above. All replaced parts and products become the property of La Crosse Technology, Ltd and must be returned to La Crosse Technology, Ltd. Replacement parts and products assume the remaining original warranty, or ninety (90) days, whichever is longer. La Crosse Technology, Ltd will pay all expenses for labor and materials for all repairs covered by this warranty. If necessary repairs are not covered by this warranty, or if a product is examined which is not in need of repair, you will be charged for the repairs or examination. The owner must pay any shipping charges incurred in getting your La Crosse Technology, Ltd product to a La Crosse Technology, Ltd authorized service center. La Crosse Technology, Ltd will pay ground return shipping charges to the owner of the product to a USA address only.

Your La Crosse Technology, Ltd warranty covers all defects in material and workmanship with the following specified exceptions: (1) damage caused by accident, unreasonable use or neglect (including the lack of reasonable and necessary maintenance); (2) damage occurring during shipment (claims must be presented to the carrier); (3) damage to, or deterioration of, any accessory or decorative surface; (4) damage resulting from failure to follow instructions contained in your owner's manual; (5) damage resulting from the performance of repairs or alterations by someone other than an authorized La Crosse Technology, Ltd authorized service center; (6) units used for other than home use (7) applications and uses that this product was not intended or (8) the products inability to receive a signal due to any source of interference.. This warranty covers only actual defects within the product itself, and does not cover the cost of installation or removal from a fixed installation, normal set-up or adjustments, claims based on misrepresentation by the seller or performance variations resulting from installation-related circumstances.

LA CROSSE TECHNOLOGY, LTD WILL NOT ASSUME LIABILITY FOR INCIDENTAL, CONSEQUENTIAL, PUNITIVE, OR OTHER SIMILAR DAMAGES ASSOCIATED WITH THE OPERATION OR MALFUNCTION OF THIS PRODUCT. THIS PRODUCT IS NOT TO BE USED FOR MEDICAL PURPOSES OR FOR PUBLIC INFORMATION. THIS PRODUCT IS NOT A TOY. KEEP OUT OF CHILDREN'S REACH.

This warranty gives you specific legal rights. You may also have other rights specific to your State. Some States do not allow the exclusion of consequential or incidental damages therefore the above exclusion of limitation may not apply to you.

For warranty work, technical support, or information contact:

La Crosse Technology
2809 Losey Blvd. S.
La Crosse, WI 54601
Phone: 608.782.1610
Fax: 608.796.1020

e-mail:

support@lacrossetechnology.com
(warranty work)
sales@lacrossetechnology.com
(information on other products)
web:
www.lacrossetechnology.com

Questions? Instructions? Please visit:
www.lacrossetechnology.com/7014it

All rights reserved. This handbook must not be reproduced in any form, even in excerpts, or duplicated or processed using electronic, mechanical or chemical procedures without written permission of the publisher. This handbook may contain mistakes and printing errors. The information in this handbook is regularly checked and corrections made in the next issue. We accept no liability for technical mistakes or printing errors, or their consequences.
All trademarks and patents are acknowledged.

FCC ID: OMOTX29U (transmitter)

RF Exposure mobile:

The internal / external antennas used for this mobile transmitter must provide a separation distance of at least 20 cm (8 inches) from all persons and must not be co-located or operating in conjunction with any other antenna or transmitter."

Statement according to FCC part 15.19:

This device complies with Part 15 of the FCC Rules. Operation is subject to the following two conditions: (1) this device may not cause harmful interference, and (2) this device must accept any interference received, including interference that may cause undesired operation.

Statement according to FCC part 15.21:

Modifications not expressly approved by this company could void the user's authority to operate the equipment.

Statement according to FCC part 15.105:

NOTE: This equipment has been tested and found to comply with the limits for a Class B digital device, pursuant to Part 15 of the FCC Rules. These limits are designed to provide reasonable protection against harmful interference in a residential installation. This equipment generates, uses and can radiate radio frequency energy and, if not installed and used in accordance with the instructions, may cause harmful interference to radio communications.

However, there is no guarantee that interference will not occur in a particular installation. If this equipment does cause harmful interference to radio or television reception, which can be determined by turning the equipment off and on, the user is encouraged to try to correct the interference by one or more of the following measures:

- Reorient or relocate the receiving antenna.
- Increase the separation between the equipment and receiver.
- Connect the equipment into an outlet on a circuit different from that to which the receiver is connected.

Consult the dealer or an experienced radio/TV technician for help