

Wireless Rain Station



For online video support:
<http://bit.ly/LaxTechTalk>

Instructional Manual

Model: T84237

DC:102017

Table of Contents

1	Button Function Explanation	8	NOW Rainfall Alert (silent)
2	Setup	9	Search for Rain Sensor
3	LCD Features	9	Position Rain Sensor
3	Settings Menu	9	Position Rain Station
5	Display Calendar or Indoor Temperature	9	Restart
5	Rainfall Readings	10	Help Us, Help You
6	Reset Current Rainfall Readings	10	Let's Get Social
7	Rainfall Cylinder Graph	10	Care and Maintenance
7	Rainfall History by the Month	10	Specifications
8	24 Hour Rainfall Alert	11	Warranty and Support
8	Alert Sounds Disarm Alert	11	FCC Statement
		11	Canada Statement

Button Function Explanation

For better programming instructions, please note these terms for button use:

- **Press:** Press the designated button.
- **Hold:** Hold the button for 3 seconds (or 5 seconds if resetting) then release the button.

Note: If no buttons are pressed for 20 seconds your station will return to normal rain display.

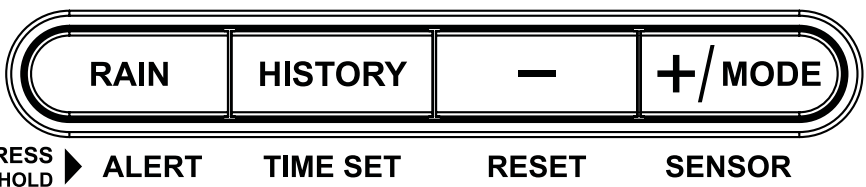

Setup

1. Insert 2 AA batteries into your rain sensor. Observe correct polarity.
2. Insert 2 AA batteries into your rain station. Observe correct polarity.
3. Optional: Tip the rocker of your rain sensor to simulate rain and receive a reading on your rain station.
4. Leave 5-10 feet apart for 15 minutes. After 15 minutes, with station and sensor connected, move your rain sensor outside to an open area.
(Position Rain Sensor-- [Page 9](#))

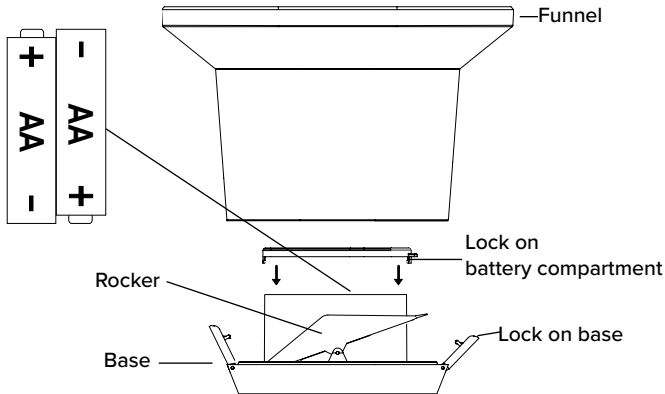

Rain Sensor:

- Flip down the locks on both sides of your rain sensor.
- Remove the funnel from the base to access the battery compartment.
- Flip up the lock on the side of the battery compartment to open.
- Insert 2-AA batteries according to polarity markings.
- Lock everything back into position.

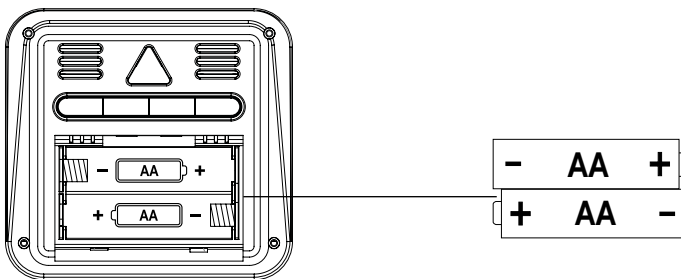

Station:

- Remove the battery cover (under the pull out stand).
- Insert 2-AA batteries according to polarity markings.

LCD Features



PM AM | PM

 Sensor Reception

°F Fahrenheit | Celsius

 Rain Alert

in Inches | Millimeters

 Low Battery

Settings Menu

- Hold the HISTORY/TIME SET button to enter the settings menu.
- Move through settings with the TIME SET button.
- The +/MODE or - button will adjust settings.

Settings Menu Order:

1. Beep ON | OFF
2. Set Hours
3. Set Minutes
4. 12 | 24 Hour time format
5. Set Year
6. Set Month
7. Set Date
8. Month/Day or Day Month order
9. Inches | Millimeters of rain
10. Fahrenheit | Celsius temperature

1. Beep ON | OFF

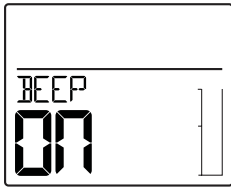

2. Set Hours

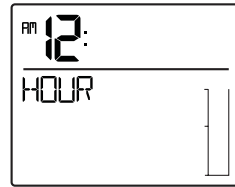

3. Set Minutes

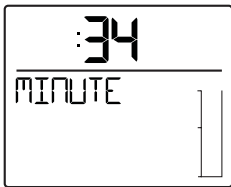

4. Choose 12 | 24 hour time

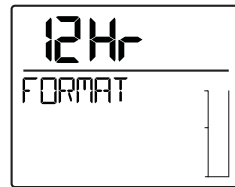

5. Set Year

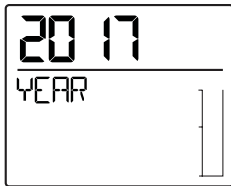

6. Set Month

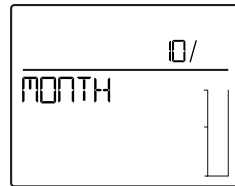

7. Set Date

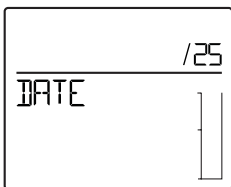

8. Month/Day | Day/Month

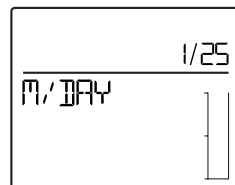

9. Select Inches | Millimeters



10. Select Fahrenheit | Celsius

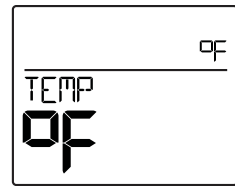

Display Calendar or Indoor Temperature

You can display either the calendar or the indoor temperature with the touch of a button.

- Press the +/MODE button to switch between the calendar display, or the indoor temperature display.

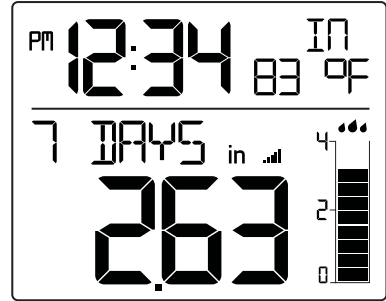
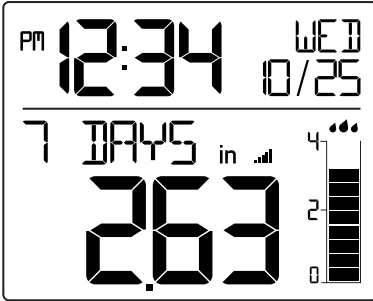

Rainfall Readings

- Press the RAIN/ALERT button to view different rain readings.
- The time/date will disappear for 20 seconds then return to normal time/date readings.
- Rainfall readings will stay on user selection.

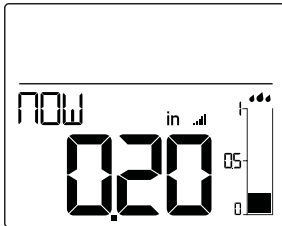

NOW:

- Rain from the start of a rain event, until no rain has accumulated for 30 minutes.
- Resets to zero after 30 minutes of no additional rainfall.

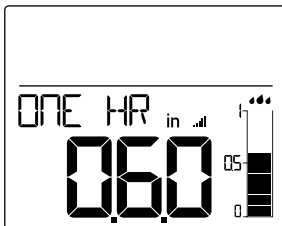

ONE HR:

- Rainfall that has accumulated during the past hour.
- Example: current time is 6:49, 1HR rain is accumulated total between 5:50 to 6:49.

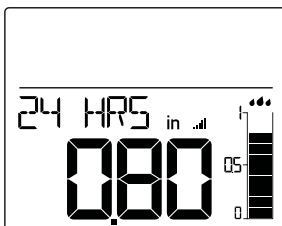

24HR:

- Rainfall based on past 24 hours of time.
- At each full hour, 1HR is recorded.
- This is a running total.

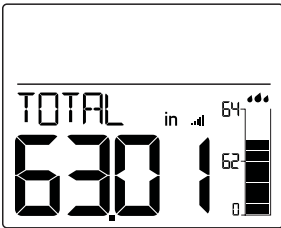
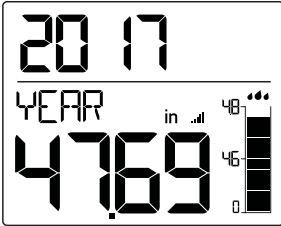
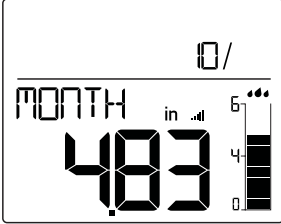
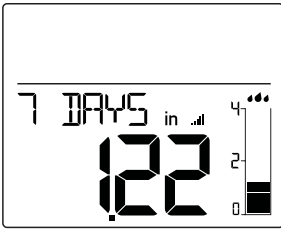

7 DAYS:

- Rainfall of last 7 consecutive 24HR rain readings.
- Updates each day at 0:00.
- Not a subject to the calendar.
- Be sure time is set.

MONTH:

- Current Month. Ex: January 1-31.
- Resets the first day of the month
- Current month will show in the date area.

YEAR:

- Current year starting January 1 total.
- Current Year will show in time display.

TOTAL:

- Total rainfall since station was powered on or reset.

Note: As time passes without rain, the Now, One Hr, 24 Hrs, and 7 day rainfall totals will count down to zero. This is normal.

Reset Current Rainfall Readings

- Press the RAIN/ALERT button to view rain readings:
(Now, One Hr, 24 Hrs, 7 Days, Month, Year or Total)
- While viewing individual rain readings, hold the -/RESET button for 3-5 seconds to reset that rainfall reading.

Note: This will not affect the 12 month history readings which are stored in memory.

Rainfall Cylinder Graph

The rain cylinder has 10 segments that change with the rainfall total. The numbers next to the cylinder graph will change with increased rainfall amounts.

Up to 1 inch of rainfall:

- Each segment indicates 0.1 inch of rainfall.
- The graph will represent 1 inch.

Over 1 inch of rainfall:

- The graph will represent 2 inches of rainfall at a time.
- Each segment indicates 0.4 inches of rainfall.
- Cylinder graph will read up to 70 inches of rain. Over 70 inches of rain, the graph will show full.

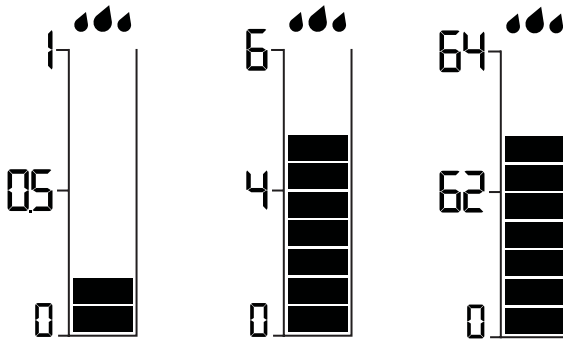

Rainfall History by the Month

- Rainfall History is viewable by the month for the past 12 months.
- Press the HISTORY/TIME SET button to view previous month's rainfall totals.
- HIST, Month, Year and Rainfall amount will show.
- The History by the month cannot be reset.

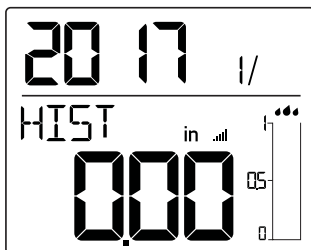

January 2017

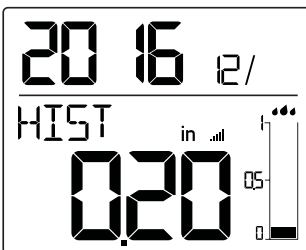

December 2016

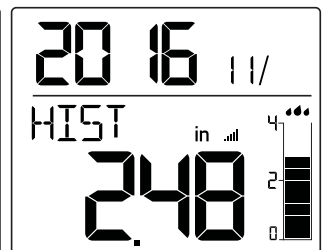

November 2016

Note: History back 12 months, then back to current month with continued presses of HISTORY/TIME SET button.

24 Hour Rainfall Alert

1. Hold the RAIN/ALERT button for 3 seconds to enter the alert settings mode.
2. Alert OFF will show. Use the - or +/MODE button to turn ON the rainfall alert.
3. When ON is selected the 24-hour rain **alert value** will show. Use the - or +/MODE buttons to adjust.
4. Press the RAIN/ALERT button to confirm and exit.

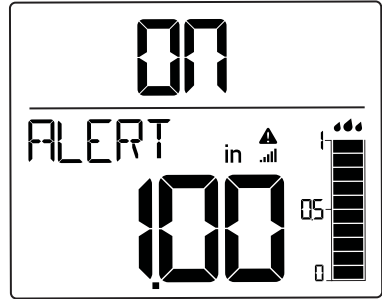
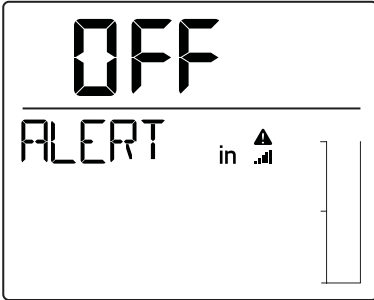

Alert Sounds | Disarm Alert

- When armed alert value is reached, station will beep 5 times each minute, until out of alert range.
- The flashing alert icon will indicate alert.
- Press any button to stop the temp alert sound.

1. Hold the RAIN/ALERT button for 3 seconds, until you see Alert ON.
2. Press the - or +/MODE button to turn alert OFF.
3. Press RAIN/ALERT to exit.

NOW Rainfall Alert (silent)

- At the beginning of a rain event (NOW), the rain drop icons will flash indicating current rainfall.
- The drops will continue to flash until the NOW reading reaches zero.
- This is a silent alert. Your station will not beep, just the raindrops will flash.
- This silent alert can not be deactivated.
- The 24 hour rainfall alert is a separate alert that is programmable.

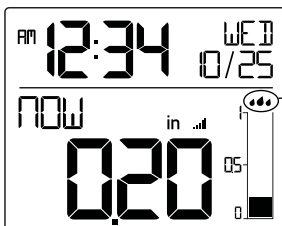

Rain drops
flash silently

Search for Rain Sensor

- Hold the SENSOR button to search for the rain sensor.
- The sensor reception icon will flash until the sensor signal is received or for 3 minutes if no signal available.
- After showing dashes for 30 minutes, the station will automatically look for the sensor signal.

Position Rain Sensor

1. Mount in an open area for a more accurate rain count.
2. Install the Rain sensor on a level platform that is stationary.
3. Insert one, two, or three mounting screws (not included) through the holes in the base of the rain sensor.
4. Ideally, your rain sensor should be mounted at least 6 ft in the air and have a direct line of sight to the display.
5. The rain sensor should be accessible to allow for periodic cleaning of debris or insects.
6. The maximum wireless transmission range to the rain station is over 300 feet (91 meters) in open air, not including walls or floors.

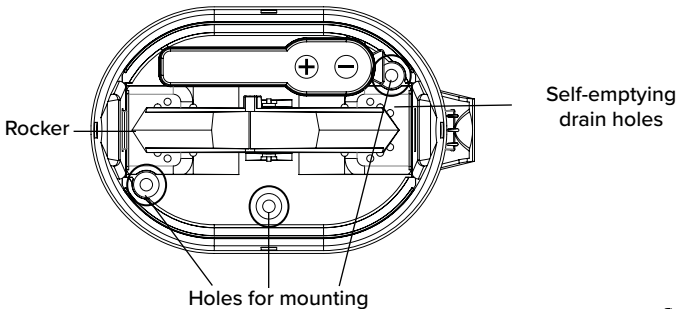

Position Rain Station

- Use the triangle hole on back to hang on the wall.
- Use the pull out stand on the battery cover to place on your desk or table.

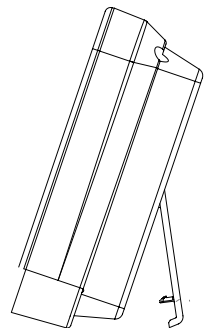

Restart

1. Remove batteries from your sensor and batteries from your station.
2. Press any button 20 times.
3. After 15 minutes insert batteries into your sensor, and into your rain station.
4. Wait 15 minutes to establish a strong connection.
5. Place sensor outside.

Help Us, Help You!

If you have ideas for features or support solutions you'd like to see us make, please let us know! We truly want to make owning a La Crosse Technology product not only a practical experience, but also a fun one.

So email us at: store@lacrossetechnology.com

Let's Be Social!

Follow us on our social media outlets for the latest promotions, product support, and awesome giveaways.



Care and Maintenance

- Do not mix old and new batteries
- Do not mix Alkaline, Standard, Lithium or Rechargeable Batteries
- Always purchase the correct size and grade of battery most suitable for use.
- Replace all batteries of a set at the same time.
- Clean the battery contacts and prior to battery installation.
- Ensure the batteries are installed with correct polarity (+ and -).
- Remove batteries from equipment which is not to be used for an extended period of time.
- Promptly remove expired batteries.

Specifications

Rain Range	0-393.6 inches (0-9999mm) over 300 feet open air 433MHz RF
Indoor Temp	+32°F to 99°F (0°C to 37°C)
Batteries	Rain Station: 2-AA, IEC, LR6 batteries (not included) TX14R Sensor: 2-AA, IEC, LR6 batteries (not included)
Battery Life	over 12 months with reputable batteries.
Dimensions	Rain Station: 3.35" H x 3.55" W x 1.19" D (8.52cm H x 9.02cm W x 3.02cm D) TX14R Sensor: 4.94" H x 7.14" W x 3.43" D (12.54cm H x 18.13cm W x 8.72cm D)

Warranty and Support

La Crosse Technology, Ltd. provides a 1-year limited time warranty (from date of purchase) on this product relating to manufacturing defects in materials & workmanship.

Before returning a product, please contact our friendly customer support or visit our online help:

Phone: 1-608-782-1610

Online: www.lacrossetechnology.com/support

FCC Statement

This equipment has been tested and found to comply with the limits for a Class B digital device, pursuant to part 15 of the FCC Rules. These limits are designed to provide reasonable protection against harmful interference in a residential installation. This equipment generates, uses and can radiate radio frequency energy, and if not installed and used in accordance with the instructions, may cause harmful interference to radio communications. However, there is no guarantee that interference will not occur in a particular installation. If this equipment does cause harmful interference to radio or television reception, which can be determined by turning the equipment off and on, the user is encouraged to try to correct the interference by one or more of the following measures:

- Reorient or relocate the receiving antenna.
- Increase the separation between the equipment and receiver.
- Connect the equipment into an outlet on a circuit different from that to which the receiver is connected.
- Consult the dealer or an experienced radio/TV technician for help.

This device must not be co-located or operating in conjunction with any other antenna or transmitter.

Operation is subject to the following two conditions:

- (1) This device may not cause harmful interference, and
- (2) This device must accept any interference received, including interference that may cause undesired operation.

Caution!

The manufacturer is not responsible for any radio or TV interference caused by unauthorized changes or modifications to this equipment. Such changes or modifications could void the user authority to operate the equipment.

All rights reserved. This manual may not be reproduced in any form, even in part, or duplicated or processed using electronic, mechanical or chemical process without the written permission of the publisher. This booklet may contain errors or misprints. The information it contains is regularly checked and corrections are included in subsequent editions. We disclaim any responsibility for any technical error or printing error, or their consequences.

All trademarks and patents are recognized.

Canada Statement

This device complies with CNR Industry Canada license -exempt devices.

Operation is subject to the following two conditions:

- (1) This device may not cause interference; and
- (2) This device must accept any interference, including interference that may cause undesired operation of the device.