

Wireless Color Forecast Station

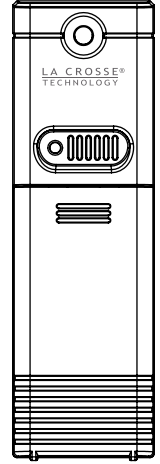
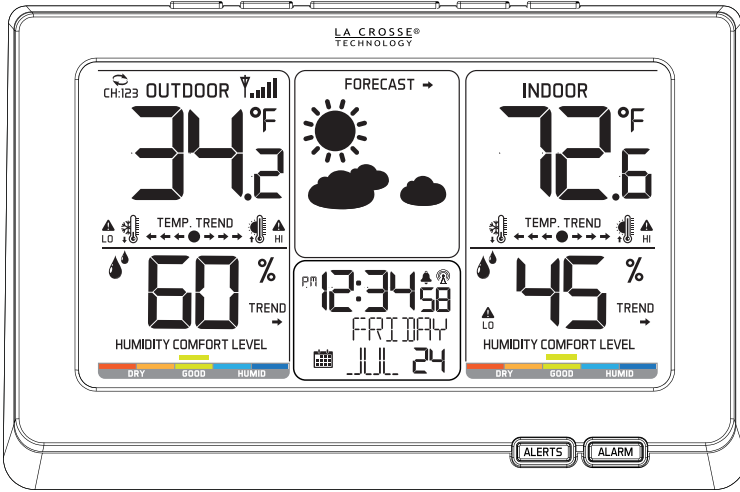

Table Of Contents

Button Location	1	Temperature Trend Indicator	10
Initial Setup	2	Humidity Trend Indicator	11
Button Functions	3	HI/LO Temp/Humidity Readings	11
Backlight Adjustment	4	Using Multiple Sensors	11
Comfort Levels	4	Changing Sensors Channels	12
LCD Layout	5	Sensor Search	12
Time Setting Order	6	Heat Index Dewpoint	12
Set Time Alarm	8	Low Battery Icon	12
Activate/Deactivate Time Alarm	8	Outdoor Sensor Positioning	12
Snooze	8	WWVB Atomic Time Signal Search	13
Forecast Indicator	9	Care and Maintenance	13
Forecast Icons	9	Warranty and Support Information	13
Temperature and Humidity Alerts	9	Specifications	14
Set Alerts	10	FCC Statement	15

Button Location

Front View

Front Buttons

- ① Alerts
- ② Alarm

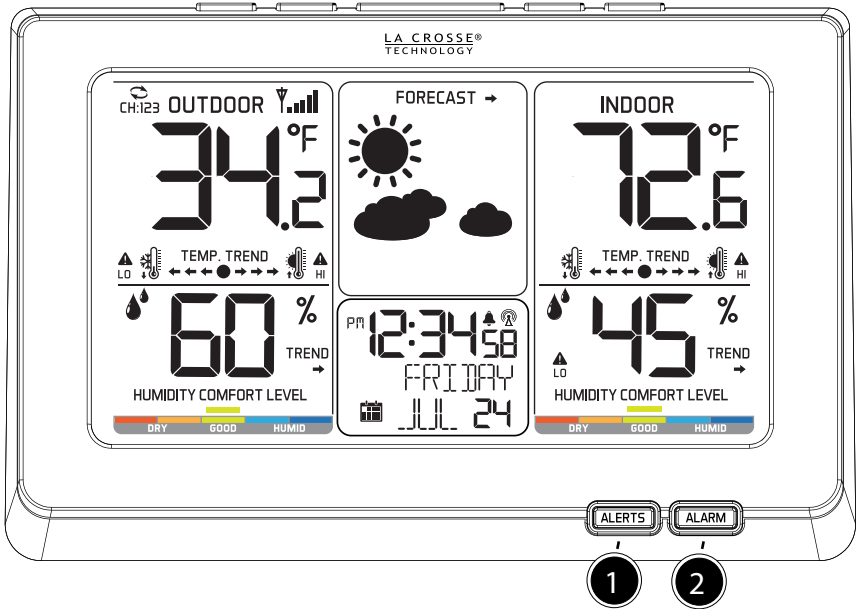

Back View

Top Buttons

- ① Up
- ② Heat/Dew
- ③ Snooze/Light (HI/LOW/OFF)
- ④ Time Set
- ⑤ Down

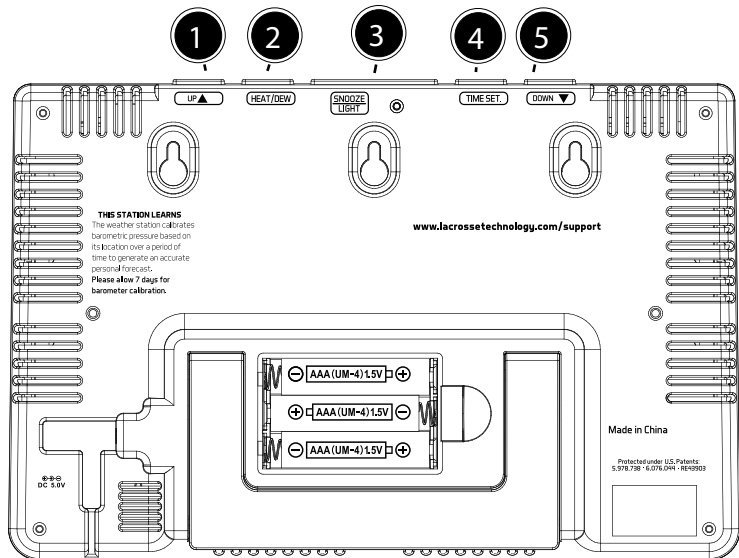

Outdoor Sensor TX141TH-BCH

Back View

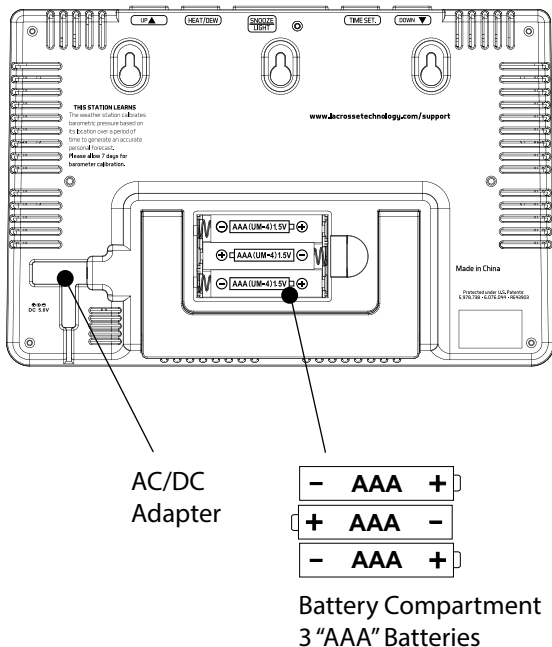
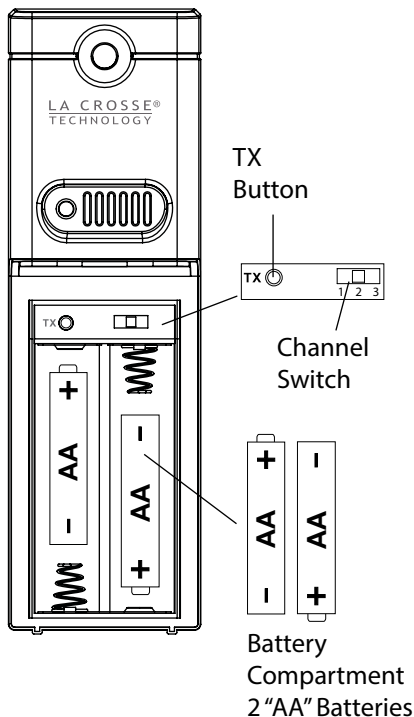

Initial Setup

Step 1: Insert the AC adapter into the outlet and into the forecast station.

Step 2 (optional): Insert 3 new "AAA" Alkaline batteries into the forecast station.

Note: Check that battery polarity is correct.

Step 3: Insert 2 new "AA" alkaline batteries into the TX141TH-BCH outdoor sensor. The red LED will flash during transmission.

Note: Check that battery polarity is correct.

Step 4: After 5 minutes, place the sensor outside.

Note: If the outdoor temperature is not displayed after 3 minutes, hold the HEAT/DEW button on the forecast station to search for outdoor sensor. Then, press the TX button on the sensor to send signal.

Button Functions

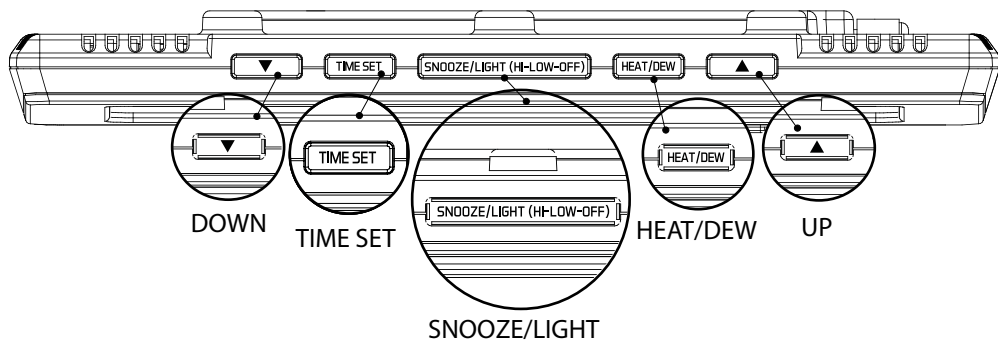

Normal Time Display:

- Press to display HI/LO temperature/humidity.
- Hold 5 seconds to clear HI/LO temperature/humidity.

Setting:

- Press button to decrease values during settings.
- Hold 2 seconds to quickly adjust values.

Alert Mode:

- Arm/Disarm alert
- Press to decrease values during settings.
- Hold for 2 seconds to quickly adjust values.



Normal Time Display:

- Press to start or stop a WWVB time signal search.
- Hold for 3 seconds to set time, calendar, etc.



Normal Time Display:

- Press to change the LCD backlight brightness. HI/LOW/OFF.
- Press to turn on backlight for 10 seconds. (when adapter is not in use)
- Press to activate the snooze function when alarm sounds.



Normal Time Display:

- Press once to view Heat Index.
- Press twice to view Dew Point.
- Hold to search for sensor.



Normal Time Display:

- Press to change channels when more than one sensor is used.

Setting:

- Press to increase the values during setting.
- Hold 2 seconds to quickly adjust values.

Alert Mode:

- Arm/Disarm alert
- Press to decrease values during settings.
- Hold for 2 seconds to quickly adjust values.

Button Functions (continued)



Normal Time Display:

- Hold the ALERTS button to enter alert set mode.

Alert Mode:

- Press the ALERTS button to set alert value if alerts is armed.
- Press to confirm and move to the next alert.



Normal Time Display:

- Press once to show alarm time.
- Hold for 2 seconds enter alarm setting mode.

Alarm Mode:

- Press to activate or deactivate the time alarm.

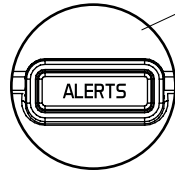
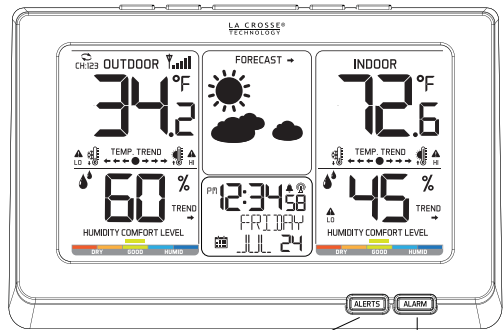

ALERTS BUTTON

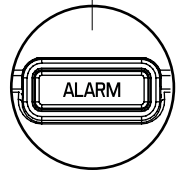

ALARM BUTTON

Backlight Adjustment

Use the AC adapter for constant backlight:

- Press the HI-LOW-OFF button on the top of the forecast station to adjust the backlight.

When using battery power only:

- Press the HI-LOW-OFF button on the top of the forecast station for the backlight to turn on for 10 seconds.

Comfort Levels

The Humidity Comfort Level lets you know the current indoor/outdoor humidity comfort level on a bright color scale.

Humidity Comfort Levels	
Orange	10 to 25%
Light Orange	26 to 39%
Green	40 to 75%
Blue	76 to 83%
Dark Blue	84 to 99%

Outdoor:

Indoor:



LCD Layout

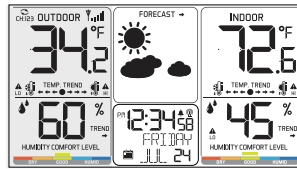
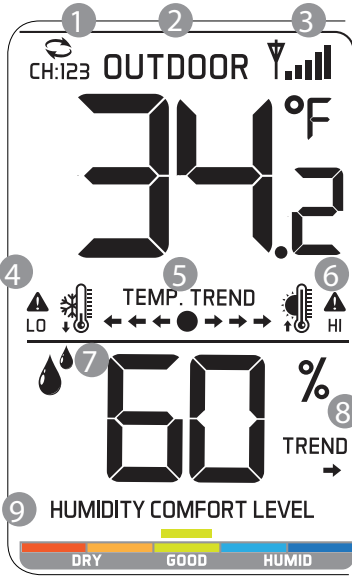

- 1 - Channel Indicator Channel Scroll Icon
- 2 - Outdoor Temperature
- 3 - Sensor Reception Icon
- 4 - Outdoor Temperature LO Alert Icon
- 5 - Temperature Trend Indicator
- 6 - Outdoor Temperature HI Alert Icon
- 7 - Outdoor Humidity
- 8 - Humidity Trend Arrow
- 9 - Humidity Comfort Level Indicator

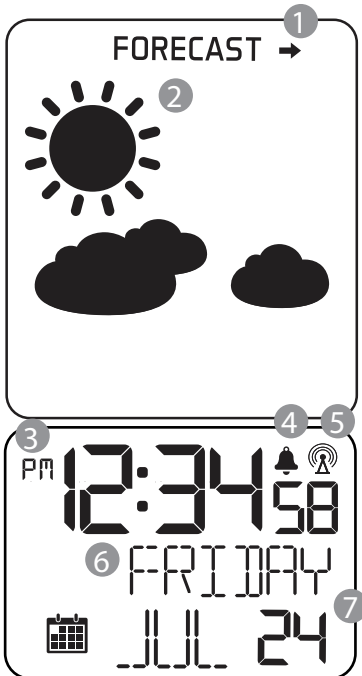

- 1 - Forecast Trend Arrow
- 2 - Animated Forecast Icon
- 3 - Atomic Time
- 4 - Alarm Bell
- 5 - Atomic Time Signal
- 6 - Weekday (English or Spanish)
- 7 - Month/Date (English or Spanish)

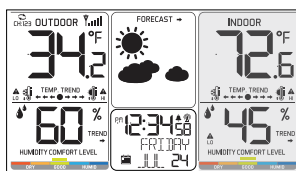
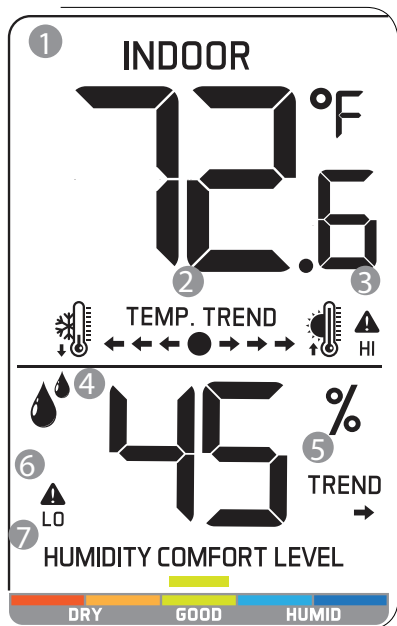

- 1 – Indoor Temperature
- 2 – Temperature Trend Indicator
- 3 – Indoor Temperature HI Alert Icon
- 4 – Indoor Humidity
- 5 – Humidity Trend Arrow
- 6 – Low Alert Symbol
- 7 – Humidity Comfort Level Indicator

Time Setting Order:

1. Beep On/Off
2. Atomic time signal (On/Off)
3. Time Zone
4. DST (Daylight Saving Time On/Off)
5. 12/24 hour time format
6. Hour
7. Minutes
8. Year
9. Month
10. Date
11. Fahrenheit/Celsius
12. Language ENG-English or ESP-Spanish

Note: When Atomic OFF is selected, you skip items 3 and 4 and go straight to 12/24 hour time format

Time Zone	
AST	Atlantic
EST	Eastern
CST	Central
MST	Mountain
PST	Pacific
AKT	Alaska
HAT	Hawaiian

Note: Weekday will set automatically.

Instructions:

- Hold the TIME SET button to enter settings menu.
- Move through settings with the TIME SET button.
- The ▲ and ▼ buttons will adjust settings.
- Exit at anytime with SNOOZE/LIGHT button.

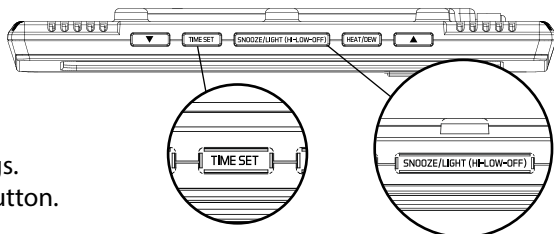

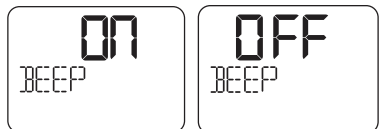
1. Beep On or OFF**2. Atomic ON (default) or OFF****3. Select Time Zone (EST Default)**

Time Zone	
AST	Atlantic
EST	Eastern
CST	Central
MST	Mountain
PST	Pacific
AKT	Alaska
HAT	Hawaiian

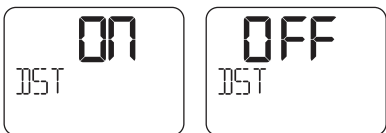
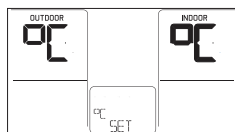
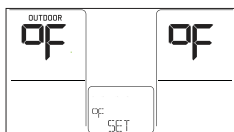
4. Select DST ON (default) or OFF**5. Choose 12 (default) or 24 hour time format****6. Set Hours****7. Set Minutes****8. Set Year****9. Set Month****10. Set Date****11. Select Fahrenheit / Celsius****12. Select Language (English or Spanish)**

Weekday:

Weekday	
English	Espanol
Monday	Lunes
Tuesday	Martes
Wednesday	Miercoles
Thursday	Jueves
Friday	Viernes
Saturday	Sabado
Sunday	Domingo

Month:

Month	
ENGLISH	ESPAÑOL
JAN	ENE
FEB	FEB
MAR	MAR
APR	ABR
MAY	MAY
JUN	JUN
JUL	JUL
AUG	AGO
SEP	SEP
OCT	OCT
NOV	NOV
DEC	DIC

Set Time Alarm

1. Hold the ALARM button for three seconds.
2. The Alarm Hour will flash.
3. Press the ▲ or ▼ buttons to adjust the hour.
4. Press the ALARM button to confirm and move to the minutes.
5. The Alarm Minutes will flash.
6. Press the ▲ or ▼ buttons to adjust the minutes.
7. Press the ALARM button to confirm and exit alarm settings.

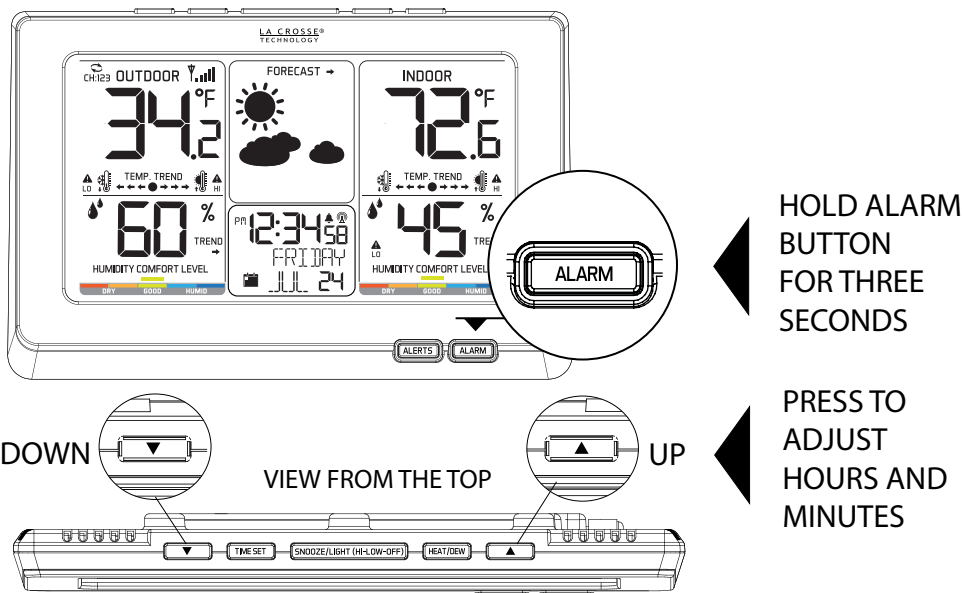

Activate/Deactivate Time Alarm

- Press the ALARM button to view alarm time.
- Press and release the ALARM button to activate or deactivate the time alarm.
- When active the alarm bell icon will show.
- When not active the alarm bell icon will disappear.

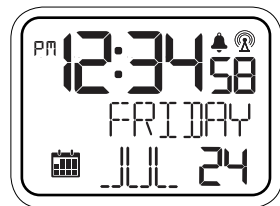

Snooze

1. Press the SNOOZE button to silence the alarm for 10 minutes.
2. The Zz will flash.
3. Press any button except SNOOZE to stop the alarm for 1 day.

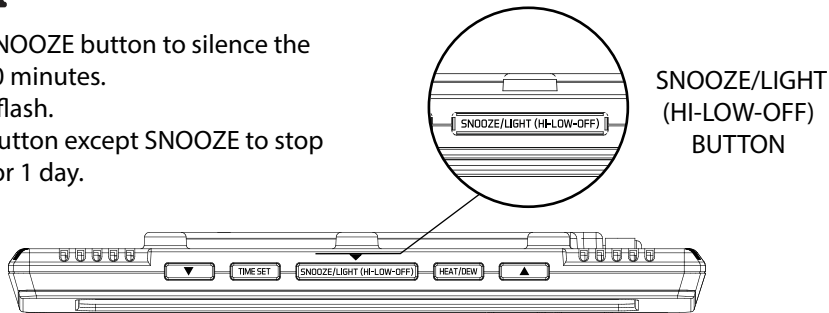

Forecast Trend Indicator

Rising Pressure ↑	Steady Pressure →	Falling Pressure ↓
Weather is expected to improve	Weather is expected to stay the same	Weather is expected to worsen

Forecast Icons

The forecast icons represent changes in weather over the next 6 -12 hours. The snow icon will appear at temperatures below 32°F in place of the storm or rain icon.

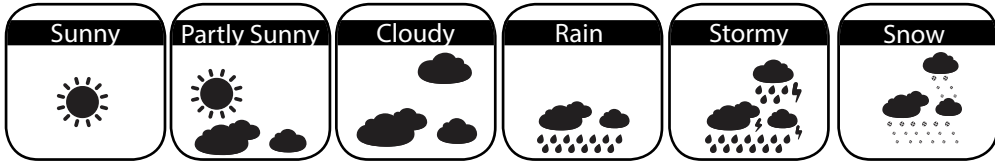

This Station Learns: The forecast station calibrates barometric pressure based on its location over a period of time to generate an accurate personal forecast. Please allow 7 to 10 days for barometer calibration.

Temperature and Humidity Alerts

Alert Setting Order:

- Outdoor HIGH Temperature • Outdoor LOW Temperature • Outdoor HIGH Humidity • Outdoor LOW Humidity • Indoor HIGH Temperature • Indoor LOW Temperature • Indoor HIGH Humidity • Indoor LOW Humidity

Quickly set outdoor and indoor temperature and/or humidity alerts.

1. Hold the ALERTS button 3 seconds to enter alert set mode.
2. Press the ▲ or ▼ buttons on the top of the forecast station to arm/disarm alerts.
3. When the alert is armed (ON) press the ALERTS button to set the alert value.
4. Press the ▲ or ▼ buttons to adjust alert values when flashing.
5. Press the ALERTS button to confirm & move to the next alert.
6. Press the LIGHT button at any time to exit.

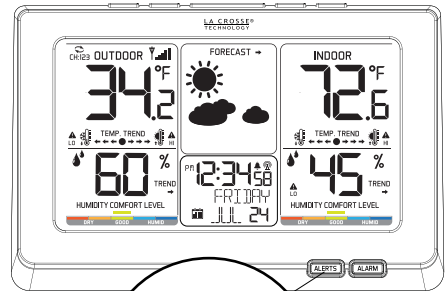

Note: If an alert is not armed (OFF), you will skip that alert value and move to arm the next alert.
Note: When using multiple sensors, select the sensor channel first, then set alerts for that sensor.

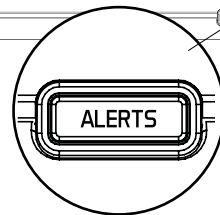

Set Alerts

1. Hold the ALERTS button to enter alert set mode.
2. Default is OFF. Use ▲ or ▼ to turn ON (arm) then set alert value.

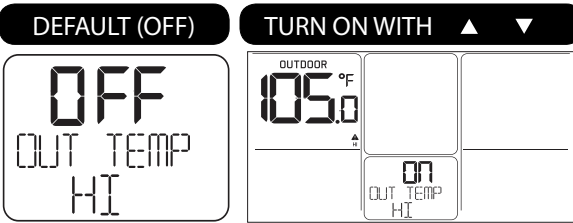

3. If you do not arm the alert, you will skip that alert value and move to the next alert option.

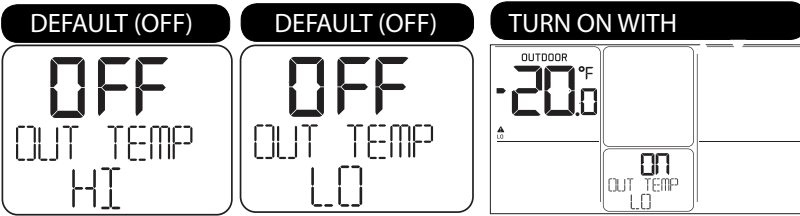

4. If you select ON (armed) you will move to set the alert value.

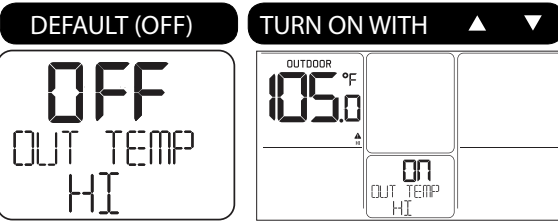

5. Press the ▲ or ▼ buttons to adjust alert value when flashing.
6. Press the ALERTS button to confirm & move to the next alert.

Temperature Trend Indicators

The temperature (2°F / 1°C) trend indicators update every 30 minutes.

- 3 hrs. increments which changes on every ½ hour e.g.: At 3:00 — compares to 12:00 data; at 3:30 — compares to 12:30, etc.

Three arrows will scroll right when temperature is rising, and scroll left when temperature is falling. When there is no change in temperature one right and one left arrow will show.

Rising Scrolls Right	Falling Scrolls Left	Steady No Scroll
TEMP. TREND ● → → → ↑	TEMP. TREND ↑ ← ← ← ●	TEMP. TREND ← ● →

Humidity Trend Indicators

The humidity (3% RH) trend indicators update every 30 minutes.

- 3 hrs. increments which changes on every ½ hour e.g.: At 3:00 — compares to 12:00 data; at 3:30 — compares to 12:30,etc.

Rising	Falling	Steady
↑	↓	→

HI and LO Temperature/Humidity Readings

All HI/LO temperature and humidity records reset automatically at 12:00 (midnight)

Hold the ▼ button for 5 seconds to manually reset all HI and LO values at one time.

1. Press the ▼ button once to view Outdoor LO temperature/humidity records.

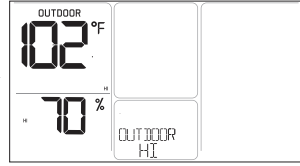

2. Press ▼ again to view the Outdoor HI temperature/humidity records.

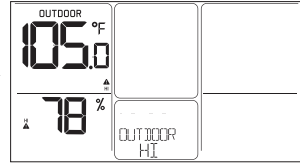

3. Press ▼ again to view the Indoor LO temperature/humidity records.

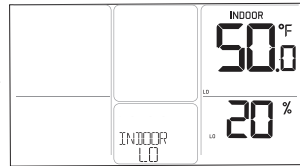

4. Press ▼ again to view the Indoor HI temperature/humidity records.

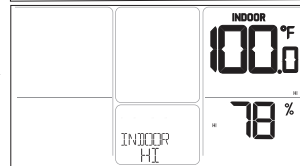

Using Multiple Sensors

Your forecast station can read up to 3 TX141TH-BCH sensors.

Add Sensors:

- Remove battery covers from all sensors.
- Set each sensor to a different channel with the switch.
- Insert batteries into all sensors.
- Hold the HEAT/DEW button on the forecast station to search for sensors.
- Press the TX button on each sensor.
- After 15 minutes place, sensors in shaded locations.

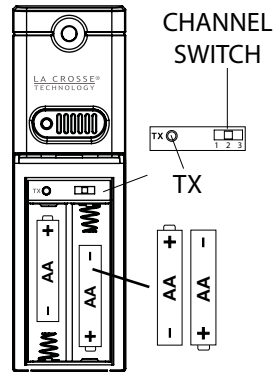

Battery Compartment
2 "AA" Batteries

Change Channels (when using multiple sensors)

From normal time display, press the ▲ button to change channels. Channel 1, 2, or 3 will show.

Remote Sensor Channels — Auto Scroll: 

- Press the ▲ button to toggle between remote sensor channels when multiple sensors are used.
- The station will automatically rotate through the channels for all connected sensors.
- Press and release the ▲ button to lock the station into one channel. Then view channels individually with a press of the ▲ button.

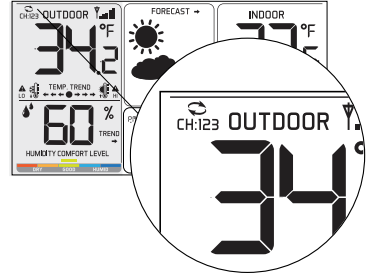

Search for Outdoor Sensor



- Hold the HEAT/DEW button for 3 seconds to search for sensors.
- The strength signal icon will animate until the sensor signal is received or for 3 minutes if no signal available.

Heat Index Dew Point:

- Press the HEAT/DEW button once to view heat index.
- Press again to view dew point.
- Press the ▲ button to change channels.

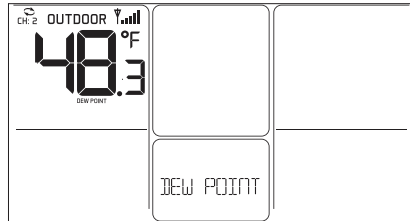
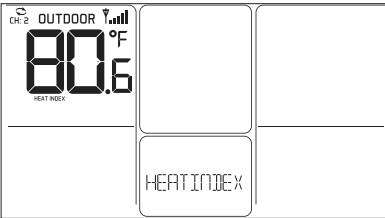

Low Battery Icon

The Low Battery Icon indicates when batteries are in the station or sensor.

- If the icon is displayed in the outdoor section, replace the batteries in the outdoor sensor.
- If the icon is displayed in the indoor section, replace the batteries in the forecast station.

Outdoor Sensor Positioning

- Mount the outdoor sensor on a north-facing wall or in any well-shaded area. Under an eave or deck rail is preferred.
- The maximum wireless transmission range to the forecast station is over 300 feet (91 meters) in open air; this does not include barriers such as walls or floors.
- Be sure the outdoor sensor is mounted vertically.

Restart

When the outdoor readings show dashes:

- Bring the sensor in the house at least five feet from the forecast station.
- Remove batteries from the sensor, as well as, the batteries and AC adapter from the forecast station.
- Press any button 20 times.
- After 15 minutes insert batteries into the sensor and station and re-connect the adapter.
- Wait 15 minutes to establish a strong connection. Place sensor outside in shaded location.

WWVB Atomic Time Signal Search



— Atomic Icon

- From normal time display press the TIME SET button once to search for the WWVB time signal.
- For information about WWVB visit:
<http://www.nist.gov/pml/div688/grp40/wwvb.cfm>.

Care and Maintenance

- Do not mix old and new batteries
- Do not mix Alkaline, Standard, Lithium or Rechargeable Batteries
- Always purchase the correct size and grade of battery most suitable for intended use.
- Replace all batteries of a set at the same time.
- Clean the battery contacts and also those of the device prior to battery installation.
- Ensure the batteries are installed with correct polarity (+ and -).
- Remove batteries from equipment which is not to be used for an extended period of time.
- Remove expired batteries promptly.

Warranty and Support Information

La Crosse Technology, Ltd. provides a 1-year limited time warranty (from date of purchase) on this product relating to manufacturing defects in materials & workmanship.

Before returning a product, please contact our friendly customer support with questions or visit our online help (FAQS):

Phone: 1-877-408-2678

Online Product Support: www.lacrossetechnology.com/support

Product Registration: www.lacrossetechnology.com/support/register

View full warranty details online at:

www.lacrossetechnology.com/warranty_info.pdf

Warranty Address: Protected under U.S. Patents:

La Crosse Technology, Ltd. 5,978,738 | 6,076,044 | RE43903

2830 S. 26th St.

La Crosse, WI 54601



Specifications

Indoor	<ul style="list-style-type: none">• Temperature Range: 32°F to 122°F (0°C to 50°C)• Humidity Range: 10% - 99% (RH)
Outdoor	<ul style="list-style-type: none">• Temperature Range: -40°F to 140°F (-40°C to 60°C)• Alkaline Batteries: -20°F to 140°F (-29°C to 60°C)• Lithium Range: -40°F to 140°F (-40°C to 60°C) <p>Note: Temperatures below -20°F (-29°C) require Lithium batteries in the outdoor sensor</p> <ul style="list-style-type: none">• Humidity Range: 10% - 99% (RH)• Distance: Over 300 ft. (91 meters) RF 433MHz (open air)
Power	<ul style="list-style-type: none">• Forecast Station Primary AC Power: 5-volt AC power adapter• AC Adapter No.: GPU280500150WD00• Optional/Battery Backup: 3-AAA, IEC, LR3 batteries (included)• TX141TH-BCH Sensor: 2-AA, IEC, LR6, batteries (included)
Battery Life	<ul style="list-style-type: none">• Forecast Station Battery Backup: Battery life is over 36 months when using the AC adapter for primary power• TX141TH-BCH Sensor: Battery life is over 24 months when using reputable battery brands for both alkaline and lithium batteries
Dimensions	<ul style="list-style-type: none">• Forecast Station: 8.27" L x 2.34" W x 5.48" H (210 x 59.43 x 139.2 mm)• TX141TH-BCH Sensor: 1.57" L x 0.79" W x 5.12" H (40 x 20 x 130 mm)

FCC Statement

This equipment has been tested and found to comply with the limits for a Class B digital device, pursuant to part 15 of the FCC Rules. These limits are designed to provide reasonable protection against harmful interference in a residential installation. This equipment generates, uses and can radiate radio frequency energy and, if not installed and used in accordance with the instructions, may cause harmful interference to radio communications. However, there is no guarantee that interference will not occur in a particular installation. If this equipment does cause harmful interference to radio or television reception, which can be determined by turning the equipment off and on, the user is encouraged to try to correct the interference by one or more of the following measures:

- Reorient or relocate the receiving antenna.
- Increase the separation between the equipment and receiver.
- Connect the equipment into an outlet on a circuit different from that to which the receiver is connected.
- Consult the dealer or an experienced radio/TV technician for help.

This device must not be co-located or operating in conjunction with any other antenna or transmitter. Operation is subject to the following two conditions:
(1) this device may not cause harmful interference, and
(2) this device must accept any interference received, including interference that may cause undesired operation.

Caution!

The manufacturer is not responsible for any radio or TV interference caused by unauthorized modifications to this equipment. Such modifications could void the user authority to operate the equipment.

All rights reserved. This manual may not be reproduced in any form, even in part, or duplicated or processed using electronic, mechanical or chemical process without the written permission of the publisher.

This booklet may contain errors or misprints. The information it contains is regularly checked and corrections are included in subsequent editions. We disclaim any responsibility for any technical error or printing error, or their consequences.

All trademarks and patents are recognized.