

# ATOMIC DIGITAL WALL CLOCK INSTRUCTION MANUAL



MODEL: 513-1919  
DC: 102919

# TABLE OF CONTENTS

- [3. Power Up](#)
- [3. Custom Date Display](#)
- [3. Indoor Comfort Statement](#)
- [4. LCD Features](#)
- [5. Settings Menu](#)
- [6. Atomic Time](#)
- [7. Time Alarm](#)
  - [Set Alarm](#)
  - [Activate/Deactivate Alarm](#)
  - [Snooze Alarm](#)
- [7. Indoor/Outdoor Temperature](#)
- [8. Temperature Trend Arrow](#)
- [8. Outdoor Sensor Reception](#)
- [8. Factory Restart](#)
- [8. Low Battery Indicators](#)
- [8. Sensor Weather Shield](#)
- [9. We're Here to Help!](#)
- [79 Join the Conversation](#)
- [9. Specifications](#)
- [10. Care and Maintenance](#)
- [10. Warranty Info](#)
- [10. FCC Statement](#)

## POWER UP

1. Insert 2-AA batteries into your Outdoor Sensor.
2. Insert 2-AA batteries into your Digital Clock.
3. Once the Outdoor Sensor is reading to your clock, place it outside in a shaded location to protect it from the sun's heat.

Watch sensor mounting video: [bit.ly/TH\\_SensorMounting](http://bit.ly/TH_SensorMounting)

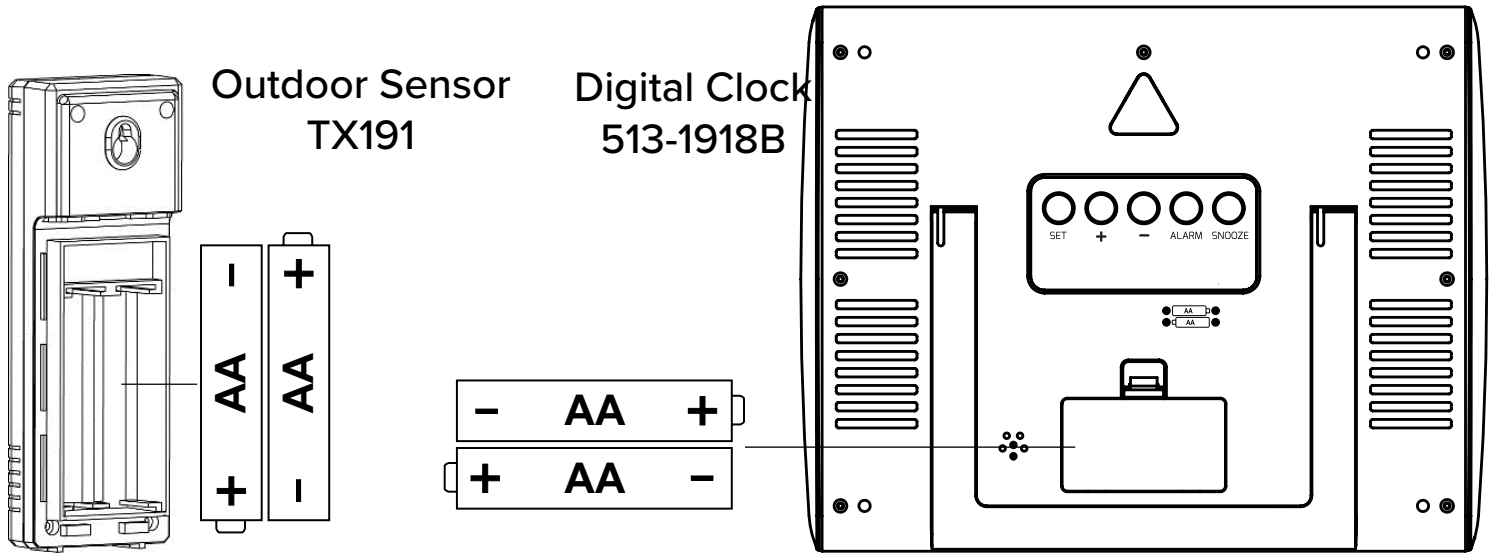

## CUSTOM DATE DISPLAY

This versatile clock allows you to display outdoor temperature or seconds counting in the outdoor temperature area. Press the + button to toggle between outdoor temperature, or seconds. Clock will stay on the selected option.

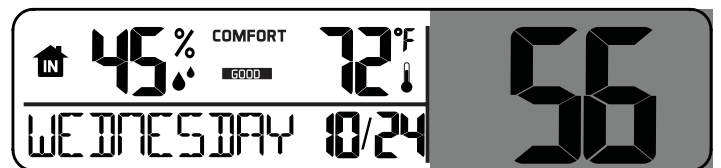
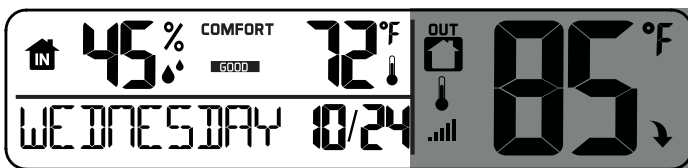

## INDOOR COMFORT STATEMENT

- The indoor comfort indicator tells you at a glance if the humidity level in your home is humid, comfortable or dry.
- With this indicator you can decide to add or remove humidity for optimal comfort.

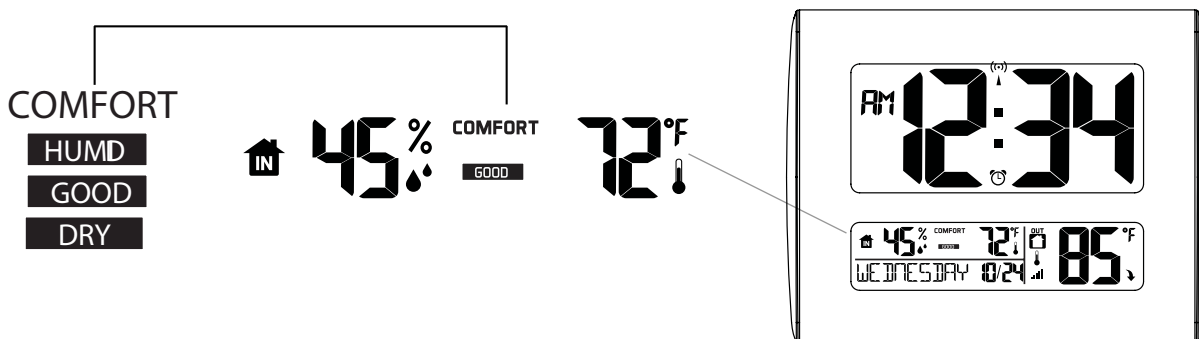

# LCD FEATURES

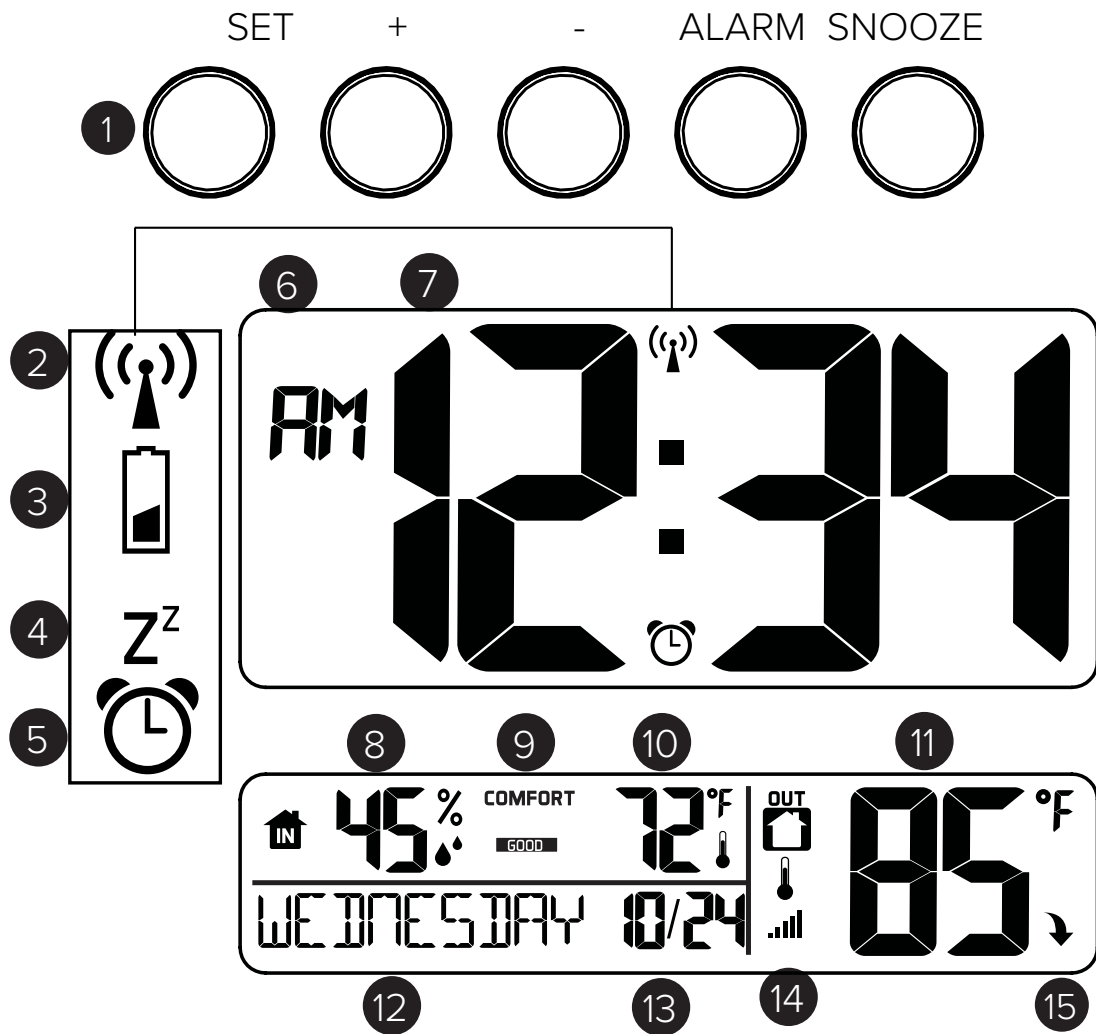

- |                                 |                              |
|---------------------------------|------------------------------|
| 1 Buttons (on back)             | 9 Indoor Comfort Statement   |
| 2 Atomic Signal Reception Tower | 10 Indoor Temperature        |
| 3 Low Battery Icon (Clock)      | 11 Outdoor Temp or Seconds   |
| 4 Snooze Icon                   | 12 Weekday                   |
| 5 Alarm Icon                    | 13 Month/Date                |
| 6 AM/PM Indicator               | 14 Sensor Reception Strength |
| 7 Atomic Time                   | 15 Outdoor Temperature Trend |
| 8 Indoor Humidity               |                              |

# SETTINGS

1. Hold the SET button to enter the Settings Menu.
2. Use the + or - button to adjust values.
3. Press the SET button to confirm and move to next item.
4. Press the SNOOZE button at anytime to exit.

## Settings Menu Order:

- Beep ON | OFF
- Atomic ON | OFF
- Daylight Saving Time ON | OFF
- Time Zone
- 12/24 Hour Time
- Hour
- Minutes
- Year
- Month
- Date
- Fahrenheit | Celsius

**Atomic OFF:** When OFF is selected the next step will be the Hour setting.

**Weekday:** Weekday will set automatically when Year, Month and Date are set.

BEEP SOUND ON/OFF

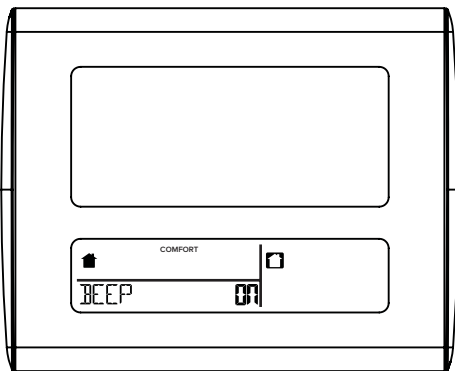

ATOMIC TIME SIGNAL ON/OFF

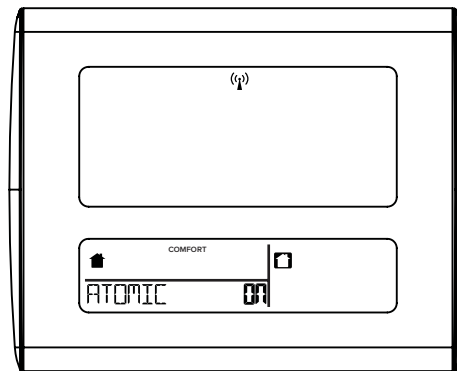

DAYLIGHT SAVING TIME

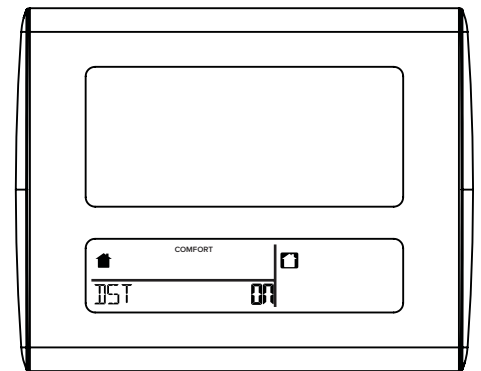

TIME ZONE

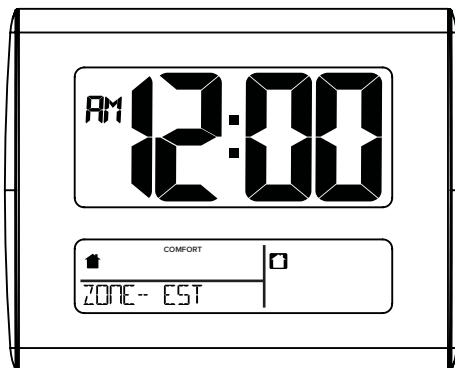

## TIME ZONES

- AST = Atlantic
- EST = Eastern
- CST = Central
- MST = Mountain
- PST = Pacific
- AKT = Alaska
- HAT = Hawaii

12/24 HOUR TIME

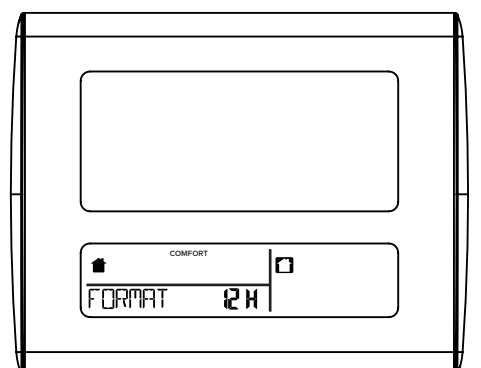

HOUR

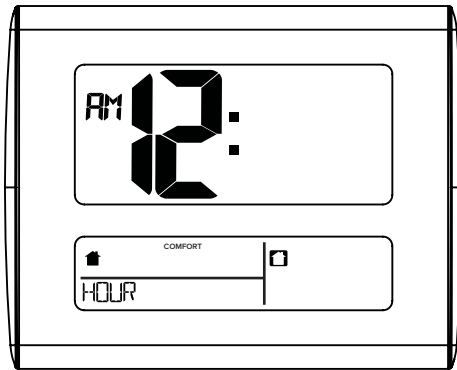

MINUTES

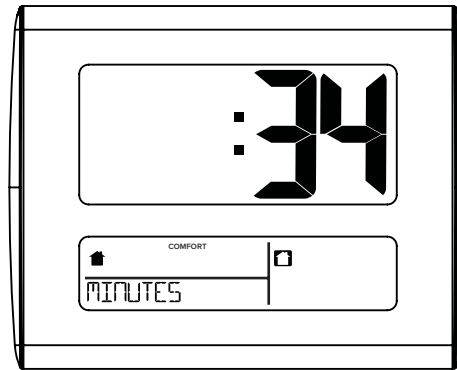

YEAR

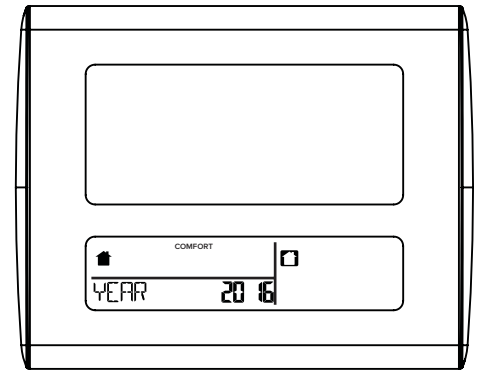

MONTH

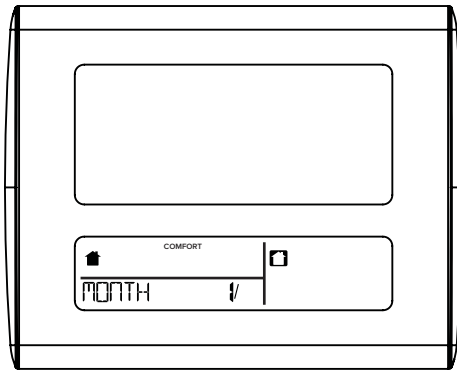

DATE

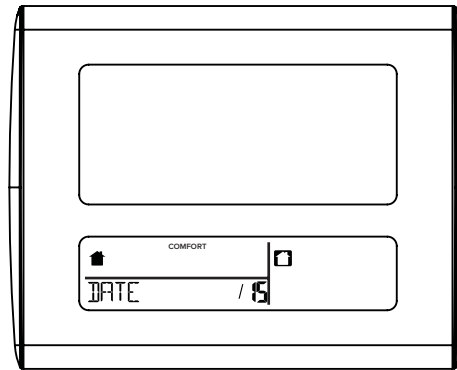

FAHRENHEIT/CELSIUS

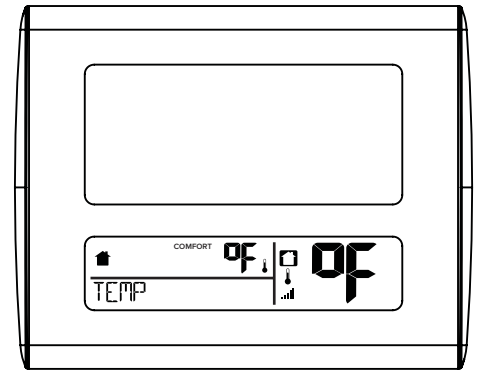

## ATOMIC TIME

- Your Clock will automatically search for the Atomic Time Signal at UTC 7:00, 8:00, 9:00, 10:00, and 11:00.
- Press the SET button to manually start or stop search for the WWVB Atomic Time Signal.
- While searching, the Tower Icon (📶) will flash. The Tower Icon will be solid when the WWVB Signal is received by your clock.
- Please be sure you have selected your time zone from the list in the Settings menu. When the Atomic time signal is received, the clock will set to the time zone selected. Default is Eastern time.
- For information about WWVB Atomic Time visit: [bit.ly/AtomicTime](https://bit.ly/AtomicTime)

# TIME ALARM

## Set Time Alarm

1. Hold the ALARM button 2 seconds to enter settings mode.
2. Press the + or - button to adjust the flashing values. Hold the + or - buttons to adjust quickly.
3. Press the ALARM button to confirm adjustments and move to the next item.
4. Press the SNOOZE button at any time to exit.

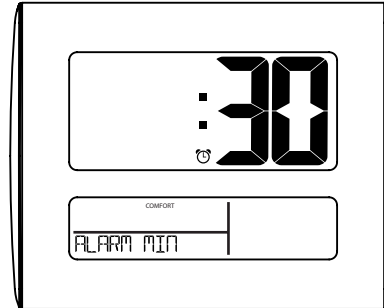
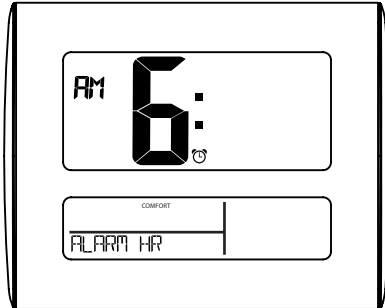

## Activate/Deactivate Time Alarm

- The alarm is active when set.
- From normal time display, press and release the ALARM button to deactivate or activate the alarm. The alarm time will show for 2 seconds.
- Alarm icon  will show then active.

## Snooze Alarm

- When alarm sounds, press the SNOOZE button to silence alarm for 10 minutes.
- The snooze icon **Zz** will flash
- Press any button except SNOOZE to silence the alarm for 24 hours

# INDOOR/ OUTDOOR TEMPERATURE

- Indoor and outdoor temperature and humidity are displayed in the lower section of the clock.
- Select Fahrenheit or Celsius in the Settings menu.
- Temperature trend arrows track temperature over the past 3 hours.
- The outdoor sensor reception signal indicates the connection strength between sensor and clock.

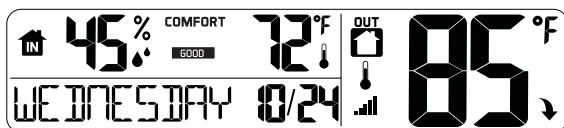

Temperature/Humidity

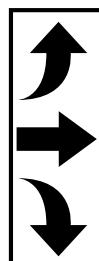



Temperature  
Trend  
Arrows

## TEMPERATURE TREND ARROWS

The outdoor temperature (2°F / 1°C) trend indicators update every 30 minutes or less. This provides a 3 hour comparison which changes on every ½ hour:

**Example:** At 3:00 - compare to 12:00 data; at 3:30 -compare to 12:30 ..... etc.

|  |  |  |
|--|--|--|
| <br>Temperature rose over<br>the past 3 hours | <br>Temperature is unchanged<br>over the past 3 hours | <br>Temperature fell over<br>the past 3 hours |
|--|--|--|

## OUTDOOR SENSOR RECEPTION

- Hold the - button 3 seconds to search for the sensor.
- The strength signal icon  will flash until the sensor signal is received or for 3 minutes if no signal is available.
- The signal will show solid when connected to the sensor.

## FACTORY RESTART

When the outdoor readings show dashes and searching for the sensor has not helped, complete a full restart:

1. Bring the sensor in the house about five feet from the clock.
2. Remove batteries from the sensor, and from the clock
3. Press any button 20 times.
4. After 15 minutes, insert batteries into the sensor, and into the clock.
5. Wait another 15 minutes to establish a strong connection. Place sensor outside in shaded location.

## LOW BATTERY INDICATORS

- A Low Battery Indicator by the time means you need to replace the batteries in your station.

## SENSOR WEATHER SHIELD

- The Sensor Weather Shield (sold separately) is designed to protect your outdoor sensor from rain and snow.
- This shield will offer limited protection from the sun's heat.
- Optional purchase at: [bit.ly/925-1418](https://bit.ly/925-1418)





## WE'RE HERE TO HELP!

If you require additional support, get in touch with our friendly customer support team based out of La Crosse, WI.

**Phone:** 1-608-782-1610

**Online:** [bit.ly/contact\\_techsupport](https://bit.ly/contact_techsupport)

Our knowledgeable customer support team is available: Monday-Friday, 8am-6pm CST.

## JOIN THE CONVERSATION

Ask questions, watch detailed setup videos, and provide feedback on our social media outlets!

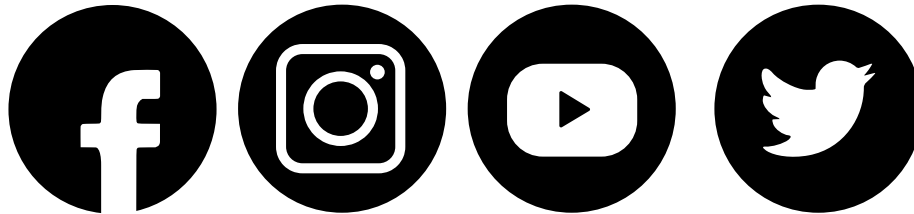

## SPECIFICATIONS

**Indoor Temp Range:** 32°F to 99°F (0°C to 37°C)

When above 99F(37C), the indoor temperature will display “HI”

When below 32F(0C), the indoor temperature will display “LO”

**Indoor Humidity Range:** 10% to 99% RH

**Outdoor Temp Range:** -40°F to 140°F (-40°C to 60°C)

**Distance:** Over 330 ft. (100 meters) RF 433MHz (open air)

**Power Clock:** 2-AA, IEC, LR6 batteries (not included)

**Power TX191:** 2-AA, IEC, LR6 batteries (not included)

**Battery Life Clock:** over 18 months with reputable batteries

**Battery Life TX191:** over 12 months with reputable batteries

**Dimensions Clock:** 9.51” W x 7.51” T x 1.0” D (24.16cm W x 19.08cm T x 2.54cm D)

**Dimensions TX191:** 1.57” W x 4.49” T x 0.94” D (3.98cm W x 11.40cm T x 2.39cm D)

# FCC STATEMENT

## WARRANTY INFO

La Crosse Technology, Ltd. provides a **1-year limited time warranty** (from date of purchase) on this product relating to manufacturing defects in materials & workmanship.

La Crosse Technology, Ltd.

2830 S. 26th St.

La Crosse, WI 54601

For Full Warranty Details, Visit: [www.lacrossetechnology.com/support](http://www.lacrossetechnology.com/support)

## CARE + MAINTENANCE

- Do not mix old and new batteries.
- Do not mix Alkaline, Lithium, standard, or rechargeable batteries.
- Always purchase the correct size and grade of battery most suitable for intended use.
- Clean the battery contacts and also those of the device prior to battery installation.
- Ensure the batteries have with correct polarity (+ / -).
- Remove batteries from equipment that will not to be used for an extended period.
- Promptly remove expired batteries.

## FCC STATEMENT

This equipment has been tested and found to comply with the limits for a Class B digital device, pursuant to part 15 of the FCC Rules. These limits are designed to provide reasonable protection against harmful interference in a residential installation.

This equipment generates, uses and can radiate radio frequency energy and, if not installed and used in accordance with the instructions, may cause harmful interference to radio communications. However, there is no guarantee that interference will not occur in a particular installation. If this equipment does cause harmful interference to radio or television reception, which can be determined by turning the equipment off and on, the user is encouraged to try to correct the interference by one or more of the following measures:

- Reorient or relocate the receiving antenna.
- Increase the separation between the equipment and receiver.
- Connect the equipment into an outlet on a circuit different from that to which the receiver is connected.
- Consult the dealer or an experienced radio/TV technician for help.

This device complies with Part 15 of the FCC Rules. Operation is subject to the following two conditions:

- (1) This device may not cause harmful interference, and
- (2) This device must accept any interference received, including interference that may cause undesired operation.

## CAUTION!

Any changes or modifications not expressly approved by the party responsible for compliance could void the user's authority to operate the equipment.

All rights reserved. This manual may not be reproduced in any form, even in part, or duplicated or processed using electronic, mechanical or chemical process without the written permission of the publisher.

This booklet may contain errors or misprints. The information it contains is regularly checked and corrections are included in subsequent editions. We disclaim any responsibility for any technical error or printing error, or their consequences. All trademarks and patents are recognized.



**WARNING:** This product can expose you to chemicals including styrene, which is known to the State of California to cause cancer. For more information go to: [www.P65Warnings.ca.gov](http://www.P65Warnings.ca.gov)