

LA CROSSE®
TECHNOLOGY

ATOMIC DIGITAL WALL CLOCK INSTRUCTION MANUAL



MODEL: 513-1918B
DC: 071321

TABLE OF CONTENTS

- [3. Power Up](#)
- [3. Custom Date Display](#)
- [4. Settings Menu](#)
- [5. Daylight Saving Time Options](#)
- [5. Atomic Time](#)
- [6. Time Alarm](#)
 - [Set Alarm](#)
 - [Activate/Deactivate Alarm](#)
 - [Snooze Alarm](#)
- [6. Outdoor Sensor Reception](#)
- [7. Factory Restart](#)
- [7. Low Battery Indicators](#)
- [7. Sensor Weather Shield](#)
- [7. We're Here to Help!](#)
- [7. Join the Conversation](#)
- [8. Specifications](#)
- [8. Care and Maintenance](#)
- [8. Warranty Info](#)
- [9. FCC Statement](#)

POWER UP

1. Insert 2-AA batteries into your Outdoor Sensor.
2. Insert 3-AAA batteries into your Digital Clock.
3. Once the Outdoor Sensor is reading to your clock, place it outside in a shaded location to protect it from the sun's heat.

Watch sensor mounting video: bit.ly/TH_SensorMounting

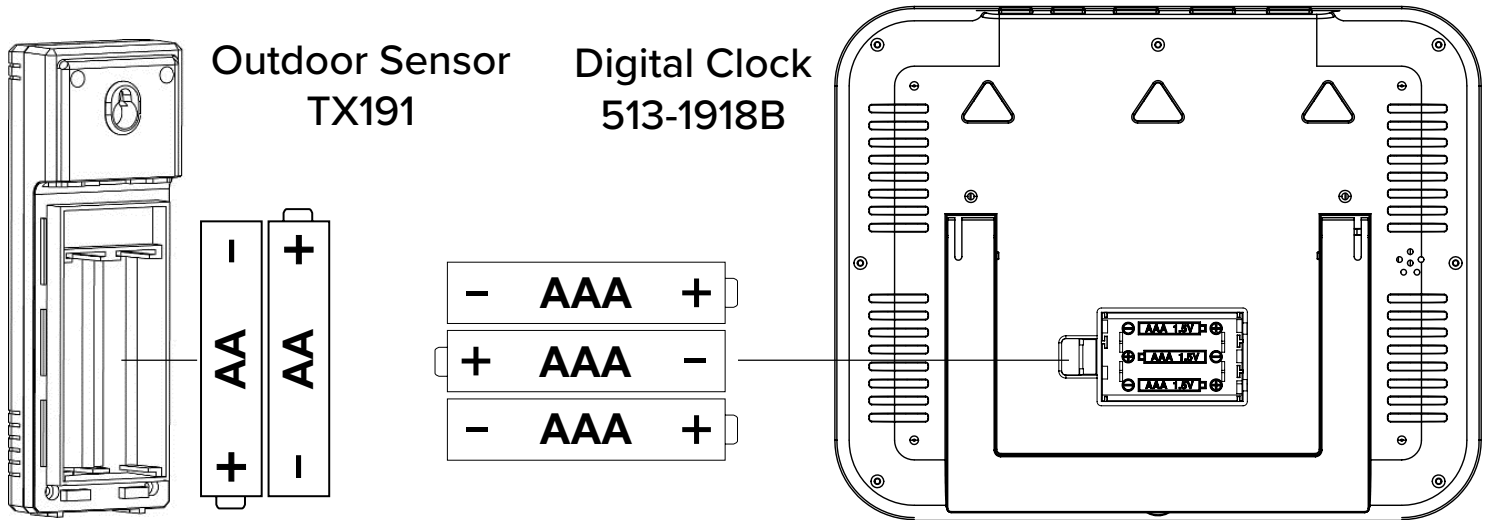

CUSTOM DATE DISPLAY

Choose to display the Full Weekday or Weekday with Month and Date. Simply press the SET button to select you desire display.

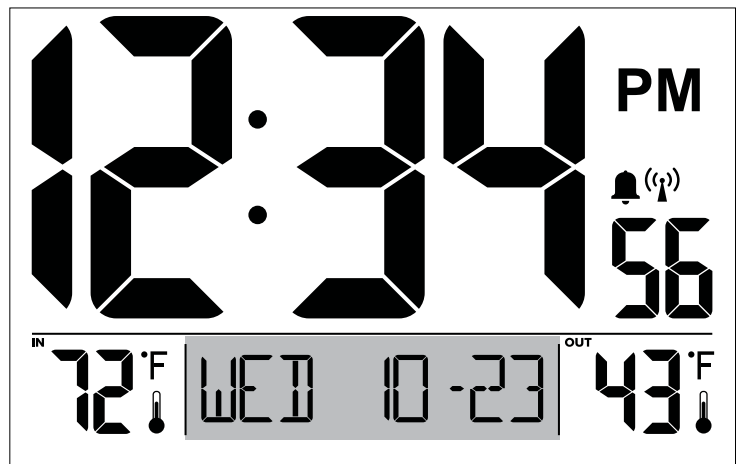
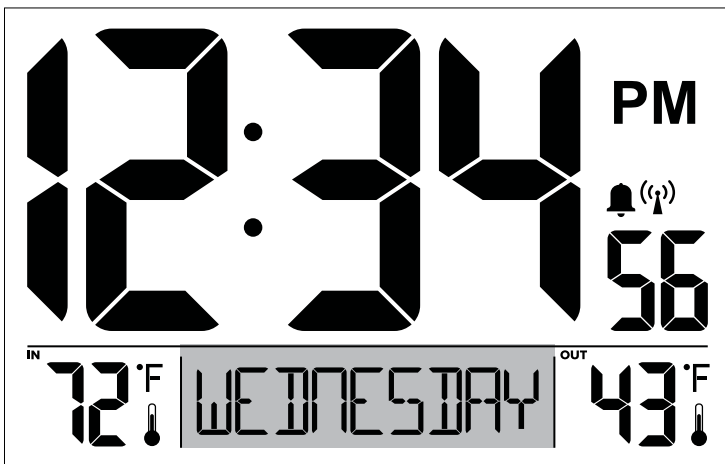

SETTINGS

1. Hold the SET button to enter the Settings Menu.
2. Use the + or - button to adjust values.
3. Press the SET button to confirm and move to next item.

Settings Menu Order:

- Language English | Spanish | French
- Beep ON | OFF
- Atomic ON | OFF
- Daylight Saving Time
 - DST AUTO ON (Gain 1 hour in spring, lose 1 hour in fall)
 - DST OFF (Remain in Standard Time all year long)
 - DST ON (Remain in Daylight Saving Time all year long)
- Time Zone
- Hour
- Minutes
- Year
- Month
- Date
- Fahrenheit | Celsius

Atomic OFF: When OFF is selected the next step will be the Hour setting.

Language: Whichever language is selected, the following instructions and weekday will be presented in that language.

Weekday: Weekday will set automatically when Year, Month and Date are set.

LANGUAGE



BEEP SOUND ON/OFF

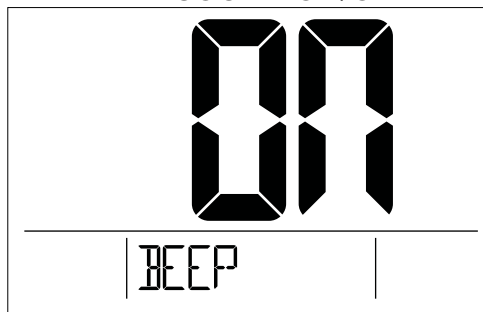

ATOMIC TIME SIGNAL ON/OFF

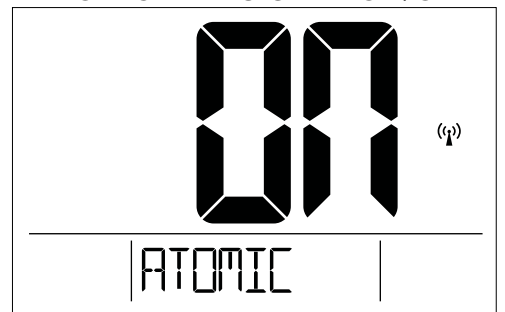

DAYLIGHT SAVING TIME

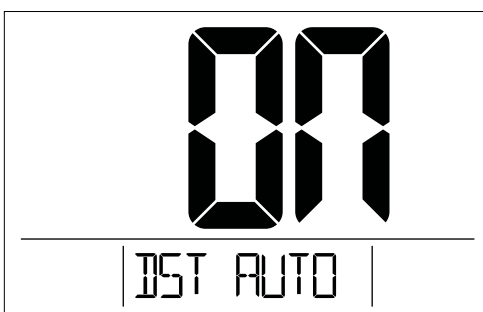

TIME ZONE



TIME ZONES

- AST = Atlantic
- EST = Eastern
- CST = Central
- MST = Mountain
- PST = Pacific
- AKT = Alaska
- HAT = Hawaii

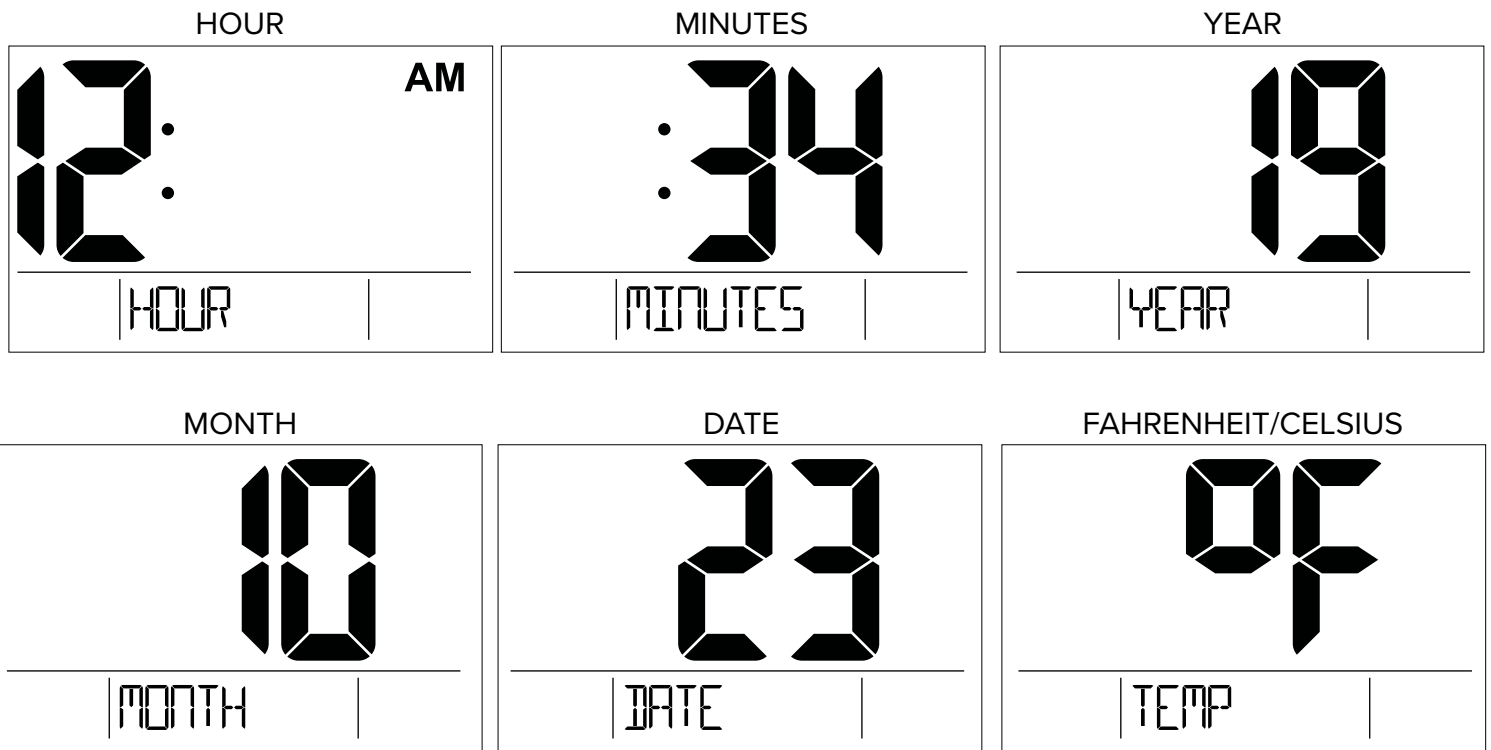

DAYLIGHT SAVING TIME OPTIONS

Some states are considering going to year around Daylight Saving Time. We have built in options to accommodate this feature into the program menu.

DST AUTO ON: Your clock will automatically move 1 hour ahead in the spring and move one hour back in the fall when it receives the signal from the Atomic Clock to change.

DST OFF: This is for areas who do not move forward one hour in the spring. Select DST OFF to remain in Standard Time all year.

DST ON: This is for areas who do not move backward one hour in the fall. Select DST ON to remain in Daylight Saving Time all year.

ATOMIC TIME

- Your Clock will automatically search for the Atomic Time Signal at UTC 7:00, 8:00, 9:00, 10:00, and 11:00.
- Press the PLUS (+) button to manually start or stop search for the WWVB Atomic Time Signal.
- While searching, the Tower Icon (📶) will flash. The Tower Icon will be solid when the WWVB Signal is received by your clock.
- For information about WWVB Atomic Time visit: bit.ly/AtomicTime

TIME ALARM

Set Time Alarm

1. Hold the ALARM button 2 seconds to enter settings mode.
2. Press the + or - button to adjust the flashing values.
3. Hold the + or - buttons to adjust quickly.
4. Press the ALARM button to confirm adjustments and move to the next item.
5. Press the SNOOZE button at any time to exit.

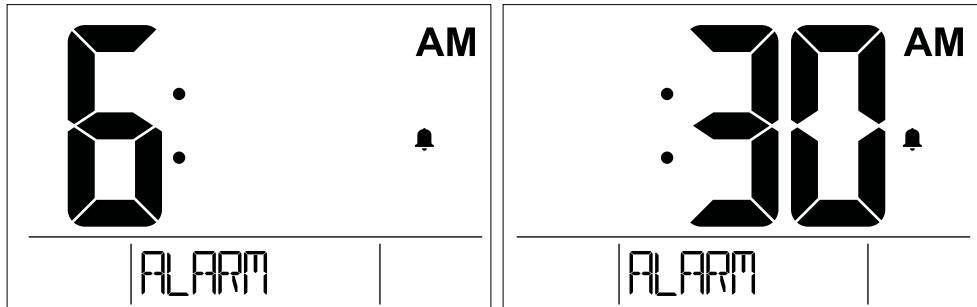

Activate/Deactivate Time Alarm

- The alarm is active when set.
- From normal time display, press and release the ALARM button to deactivate or activate the alarm. The alarm time will show for 2 seconds.
- Alarm icon (bell) will show then active.

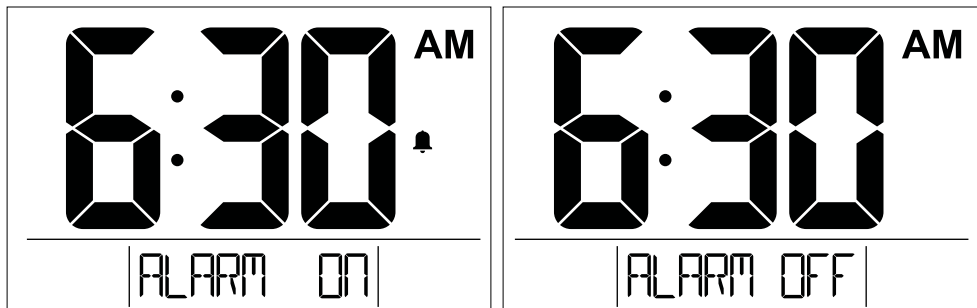

Snooze Alarm

- When alarm sounds, press the SNOOZE button to silence alarm for 10 minutes.
- The alarm icon (bell) will flash
- Press any button except SNOOZE to silence the alarm for 24 hours

OUTDOOR SENSOR RECEPTION



- If sensor loses connection to the weather station for any reason, the weather station will show NO after 30 minutes.
- The weather station will search for 3 minutes every hour to reconnect with sensor.
- Hold the PLUS (+) button 3 seconds to search for the outdoor sensor.
- Reception Icon will flash while searching for sensor. Outdoor sensor area will show dashes during the search.
- When sensor is received the icon will be solid.
- If no sensor received, the icon will disappear after 3 minutes of searching if sensor is not found. NO will again show in the outdoor sensor area.

FACTORY RESTART

Factory Restart:

When the outdoor readings show NO and searching for the sensor has not helped, complete a full restart:

1. Bring the sensor in the house about five feet from the clock.
2. Remove batteries from the sensor, and from the clock
3. Press any button 20 times.
4. After 15 minutes, insert batteries into the sensor, and into the clock.
5. Wait another 15 minutes to establish a strong connection. Place sensor outside in shaded location.

LOW BATTERY INDICATORS

- A Low Battery Indicator between the Outdoor Temperature/Humidity means you need to replace the batteries in your sensor.
- A Low Battery Indicator by the time means you need to replace the batteries in your station.

SENSOR WEATHER SHIELD

- The Sensor Weather Shield (sold separately) is designed to protect your outdoor sensor from rain and snow.
- This shield will offer limited protection from the sun's heat.
- Optional purchase at: bit.ly/925-1418



WE'RE HERE TO HELP!

If you require additional support, get in touch with our friendly customer support team based out of La Crosse, WI.

Phone: 1-608-782-1610

Online: bit.ly/contact_techsupport

Our knowledgeable customer support team is available: Monday-Friday, 8am-6pm CST.

JOIN THE CONVERSATION

Ask questions, watch detailed setup videos, and provide feedback on our social media outlets!



SPECIFICATIONS

Indoor Temperature Range: 32°F to 122°F (0°C to 50°C)

Update Interval: About every minute.

Outdoor Temperature Range: -40°F to 140°F (-40°C to 60°C)

Transmission Range: Over 330 ft. (100 meters) RF 433MHz (open air)

Update Interval: About every minute.

Power Requirements:

513-1918B: 3 “AAA” batteries (sold separately)

TX191: 2 “AA” batteries (sold separately)

Battery Life:

513-1918B: Over 18 months

TX191: Over 18 months

Dimensions:

513-1918B: 8.97” W x 0.94” D x 7.12” H (22.78 W x 2.38 D x 18.08 H cm)

TX191: 1.57” W x 0.95” D x 4.49” H (3.98 L x 2.41 W x 11.40 H cm)

CARE AND MAINTENANCE

- Do not mix old and new batteries.
- Do not mix Alkaline, Standard, Lithium, or Rechargeable batteries.
- Always purchase the correct size and grade of battery most suitable for intended use.
- Replace all batteries of a set at the same time.
- Clean the battery contacts and also those of the device prior to battery installation.
- Ensure the batteries are installed with correct polarity (+ and -).
- Remove batteries from equipment which is not to be used for an extended period of time.
- Promptly remove expired batteries.

WARRANTY INFO

La Crosse Technology, Ltd. provides a **1-year limited time warranty** (from date of purchase) on this product relating to manufacturing defects in materials & workmanship.

For Full Warranty Details, Visit: www.lacrossetechnology.com/support

FCC STATEMENT

WARRANTY INFO

La Crosse Technology, Ltd. provides a **1-year limited time warranty** (from date of purchase) on this product relating to manufacturing defects in materials & workmanship.

La Crosse Technology, Ltd.

2830 S. 26th St.

La Crosse, WI 54601

For Full Warranty Details, Visit: www.lacrossetechnology.com/support

CARE + MAINTENANCE

- Do not mix old and new batteries.
- Do not mix Alkaline, Lithium, standard, or rechargeable batteries.
- Always purchase the correct size and grade of battery most suitable for intended use.
- Clean the battery contacts and also those of the device prior to battery installation.
- Ensure the batteries have with correct polarity (+ / -).
- Remove batteries from equipment that will not to be used for an extended period.
- Promptly remove expired batteries.

FCC STATEMENT

This equipment has been tested and found to comply with the limits for a Class B digital device, pursuant to part 15 of the FCC Rules. These limits are designed to provide reasonable protection against harmful interference in a residential installation.

This equipment generates, uses and can radiate radio frequency energy and, if not installed and used in accordance with the instructions, may cause harmful interference to radio communications. However, there is no guarantee that interference will not occur in a particular installation. If this equipment does cause harmful interference to radio or television reception, which can be determined by turning the equipment off and on, the user is encouraged to try to correct the interference by one or more of the following measures:

- Reorient or relocate the receiving antenna.
- Increase the separation between the equipment and receiver.
- Connect the equipment into an outlet on a circuit different from that to which the receiver is connected.
- Consult the dealer or an experienced radio/TV technician for help.

This device complies with Part 15 of the FCC Rules. Operation is subject to the following two conditions:

- (1) This device may not cause harmful interference, and
- (2) This device must accept any interference received, including interference that may cause undesired operation.

CAUTION!

Any changes or modifications not expressly approved by the party responsible for compliance could void the user's authority to operate the equipment.

All rights reserved. This manual may not be reproduced in any form, even in part, or duplicated or processed using electronic, mechanical or chemical process without the written permission of the publisher.

This booklet may contain errors or misprints. The information it contains is regularly checked and corrections are included in subsequent editions. We disclaim any responsibility for any technical error or printing error, or their consequences. All trademarks and patents are recognized.



WARNING: This product can expose you to chemicals including styrene, which is known to the State of California to cause cancer. For more information go to: www.P65Warnings.ca.gov