

LA CROSSE®
TECHNOLOGY

Professional Weather Station



For online video support:
<http://bit.ly/LaxTechTalk>

Instructional Manual

Model: 330-2315 DC:110316

Protected under U.S. Patents: 5,978,738 | 6,076,044 | RE43903

Contents

Setup Preparation	3	Sensor Search	13
Quick Setup	3	TX233TH Temperature Humidity ...	14
Buttons	4	TX233RW Multi-sensor	14
Settings	4	Mounting Instructions	15
Display Icons	6	Replace Wind Cups	16
Wind Readings	7	Replace Directional Vane	16
Wind History	7	Clean Rain Sensor	16
Reset Wind Speed History	7	Position Weather Station	17
Rain Readings History	8	Stand Alone Station	19
Reset Rainfall Readings	8	Connected Station	19
Temperature/Humidity HI LO Readings	9	WiFi Icon	19
Set Weather Alerts	10	Visit Us on Social Media	19
Weather Alerts	10	Factory Restart	20
Active Alert	11	Care and Maintenance	20
Temperature/ Humidity Trend Arrows	11	Warranty and Support	20
Forecast Trend Arrows	11	Specifications	21
Weather Forecast Icons	12	FCC Statement	22
Seasonal Trees	12	Canada Statement	22

Setup Preparation

Items you will need to setup your station (not included):

1. Phillips head screwdriver for assembly.
2. Fresh Batteries: 5 (five) AA alkaline or lithium batteries for the sensors.
3 (three) AAA alkaline batteries for the station (optional).

For best results:

- Remove weather station and sensors from the package and place together on a table or bench, within easy reach.
- Place batteries and screwdriver within reach of setup location.
- Keep sensors and weather station 5-10 feet for at least 15 minutes after installing batteries, to allow the sensors and station to connect repeatedly.

Quick Setup

1. Power up. Insert 2-AA batteries into the outdoor Thermo-hygro sensor, 3-AA batteries into the Multi-sensor. Then plug the power cable into the display.
2. Configure basic settings. Set Time, Date etc.
3. Place outdoor sensor in a shaded location after 5 minutes.
Optional: insert 3-AAA batteries into the weather station.

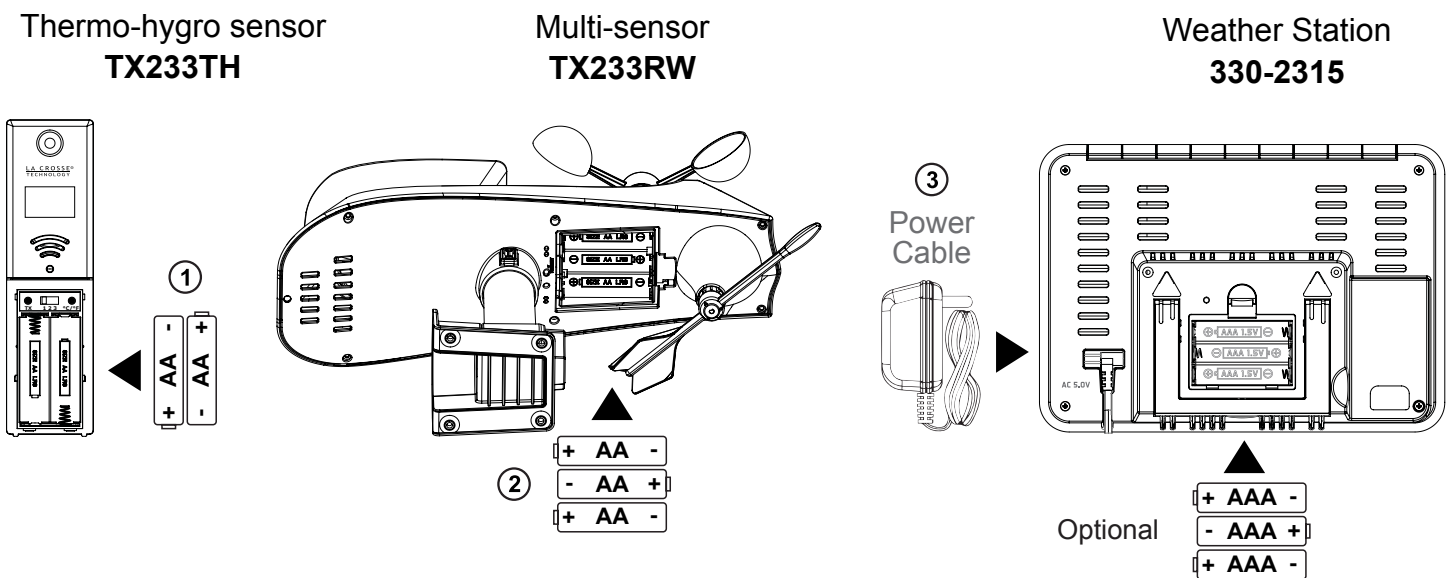

When station is powered on, the software version will show for 2 seconds in the lower left corner.

Buttons

- Buttons are located on the top of the weather station.
- When entering a settings mode, **hold** the correct button (SET, ALERTS).
- **Press and release** the +/- buttons to change a setting.
- **Press and release** the correct button to view readings (Wind, Rain, Temp/Humidity).



Settings

1. Hold the **SET** button for 3 seconds to enter time set mode.
2. Press and release the **+** or **-** buttons to adjust the values. Hold to adjust quickly.
3. Press and release the **SET** button to confirm and move to the next item.

Note: Press and release the LIGHT button any time to exit settings.

Settings order:

1. BEEP ON/OFF
2. Time zone (-12 to +12)
3. Auto DST ON/OFF (Daylight Saving Time)
4. Hour
5. Minutes
6. 12h/24h hour format
7. Year
8. Month
9. Date
10. Temperature (C/F)
11. Wind degree or direction (letters) select
12. Wind speed select (mph/kmh)
13. Rainfall unit select (in/mm)

Note: North American Time Zones are negative numbers. Setting the time zone for your location assures the time will be correct.

North America Time Zones	
-4h	Atlantic
-5h	Eastern
-6h	Central
-7h	Mountain
-8h	Pacific
-9h	Alaska
-10h	Hawaii

Note: Auto DST settings mean your station will automatically change into or out of Daylight Saving Time when ON is selected.

Note: Press only one button at a time while setting time, date, etc.

To begin: Hold the **SET** button 3 seconds, then release:

1. BEEP ON | OFF

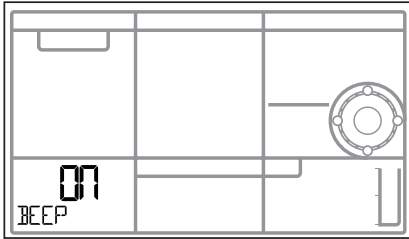

2. Time Zone (-12 to + 12)

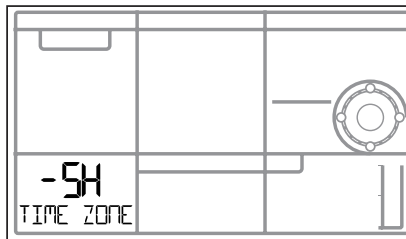

3. Auto DST ON | OFF

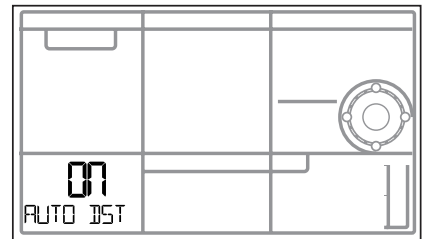

4. Hours

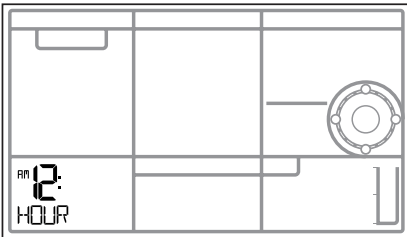

5. Minutes

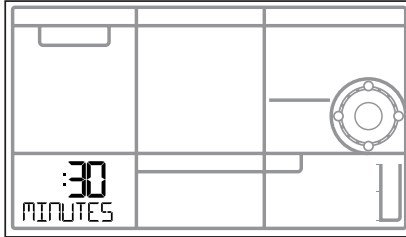

6. 12 | 24 Hour Format

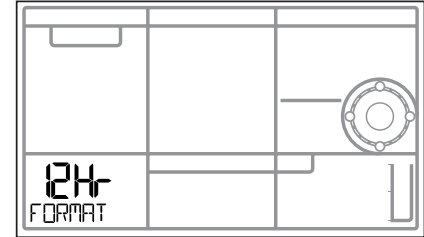

7. Year

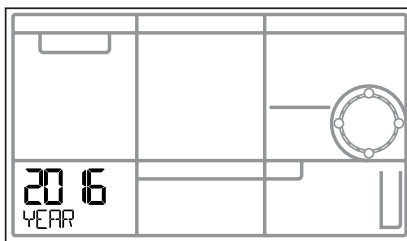

8. Month

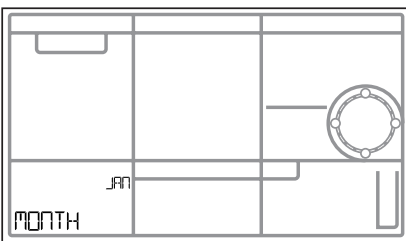

9. Date

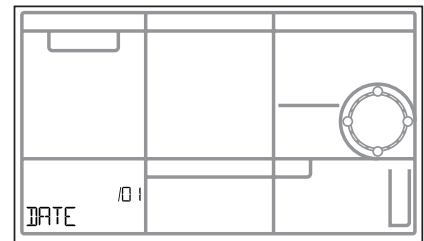

Note: The day of the week is set after Year, Month, and date are specified

10. Fahrenheit | Celsius

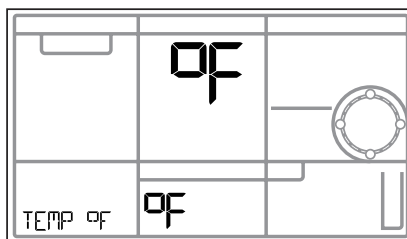

11. Wind Direction (degrees | letters)

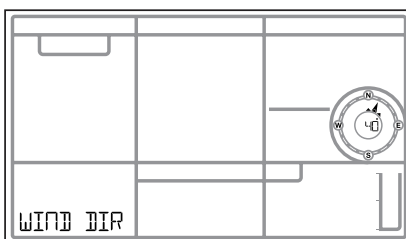

12. Wind Speed (MPH | KMH)

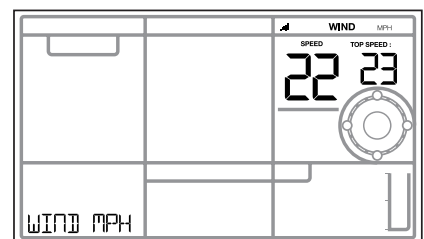

13. Rain (INCH | MM)

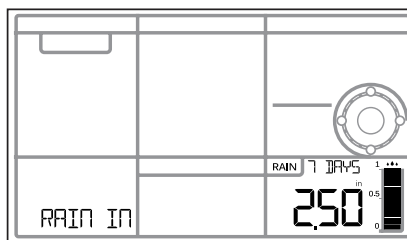

- Press the **LIGHT** button at any time to exit.
- After 20 seconds with no button press, the station will default back to normal time display.

Display Icons

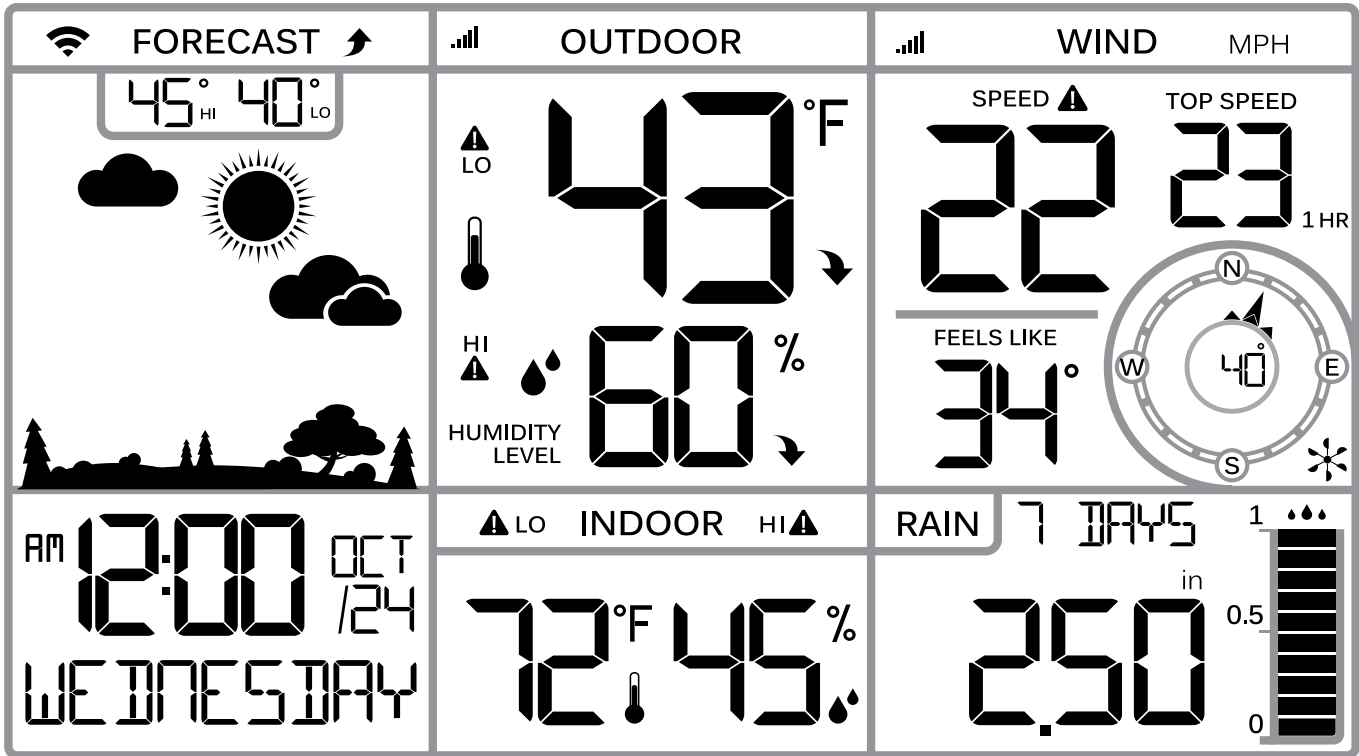

- WiFi Icon
- Forecast Icon
- Seasonal Trees
- AM/PM AM | PM
- Temperature
- Humidity
- HI | LO Alert
- °F °C Fahrenheit | Celsius
- Trend Arrows
- % Percent Humidity
- Sensor Strength
- Wind Direction
- Wind Speed
- Rainfall Graph

Wind Readings

- **Current Speed:** Highest speed in the past 30 seconds
- **Top Speed:** Highest speed in the past hour
- **Feels Like:** Temperature | Humidity | Wind Speed
- **Wind Direction:** In letters or degrees
- **History:** Press and release the WIND button to view:
 - 1 Hour (default) | 24 Hour | 7 Days | Month | Year

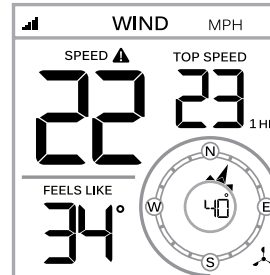
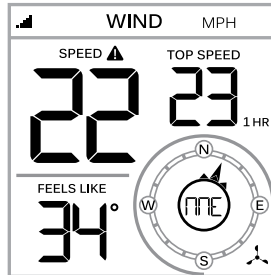

Wind History

Press and release the WIND button to view the maximum wind history values.

- One Hour: past 60 minute period (default Top Speed record, already shown)
- 24 hour: Past 24 hour period, from last record
- 7 Days: Past 7-day period, from last record
- Month: Defined by Calendar Month i.e. January 1 - January 31
- Year: Defined by Calendar Year i.e. January 1 - December 31

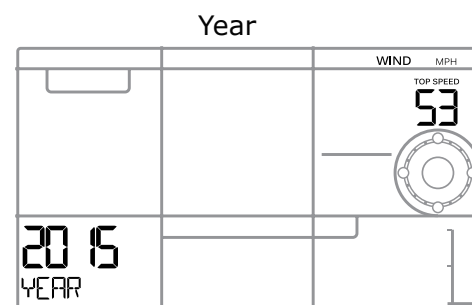
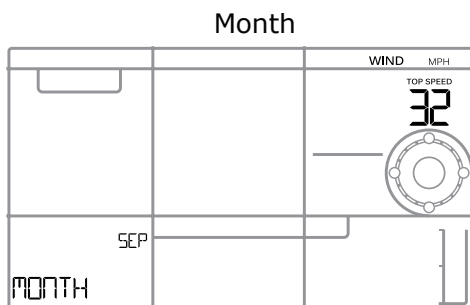
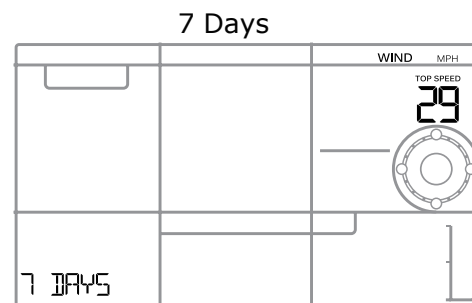
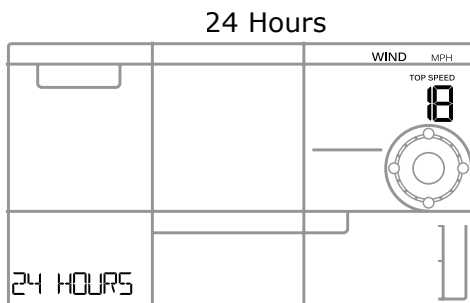

Reset Wind Speed History

- Press the WIND button to view individual wind speed readings.
- Hold the MINUS button for five seconds to reset the individual value.
- Wind speed reading will reset to current wind speed.

View Rain Readings | History

Press and release the RAIN button to view rain history.

- ONE HR: past 60 minute periods, from last record
- 24 HR: Past 24 hour period, from last record.
- DAY: 24 hr period from 12:00am - 11:59pm. With current date
- 7 DAYS: Past 7-day period, from last record
- MONTH: Defined by Calendar Month i.e. January 1 - January 31.
- YEAR: Defined by Calendar Year i.e. January 1 - December 31.
- TOTAL: running total since station was powered up (no time stamp)

Note: After viewing a history record for 5 seconds, the station will return to the normal time display and display the last rain record your viewed.

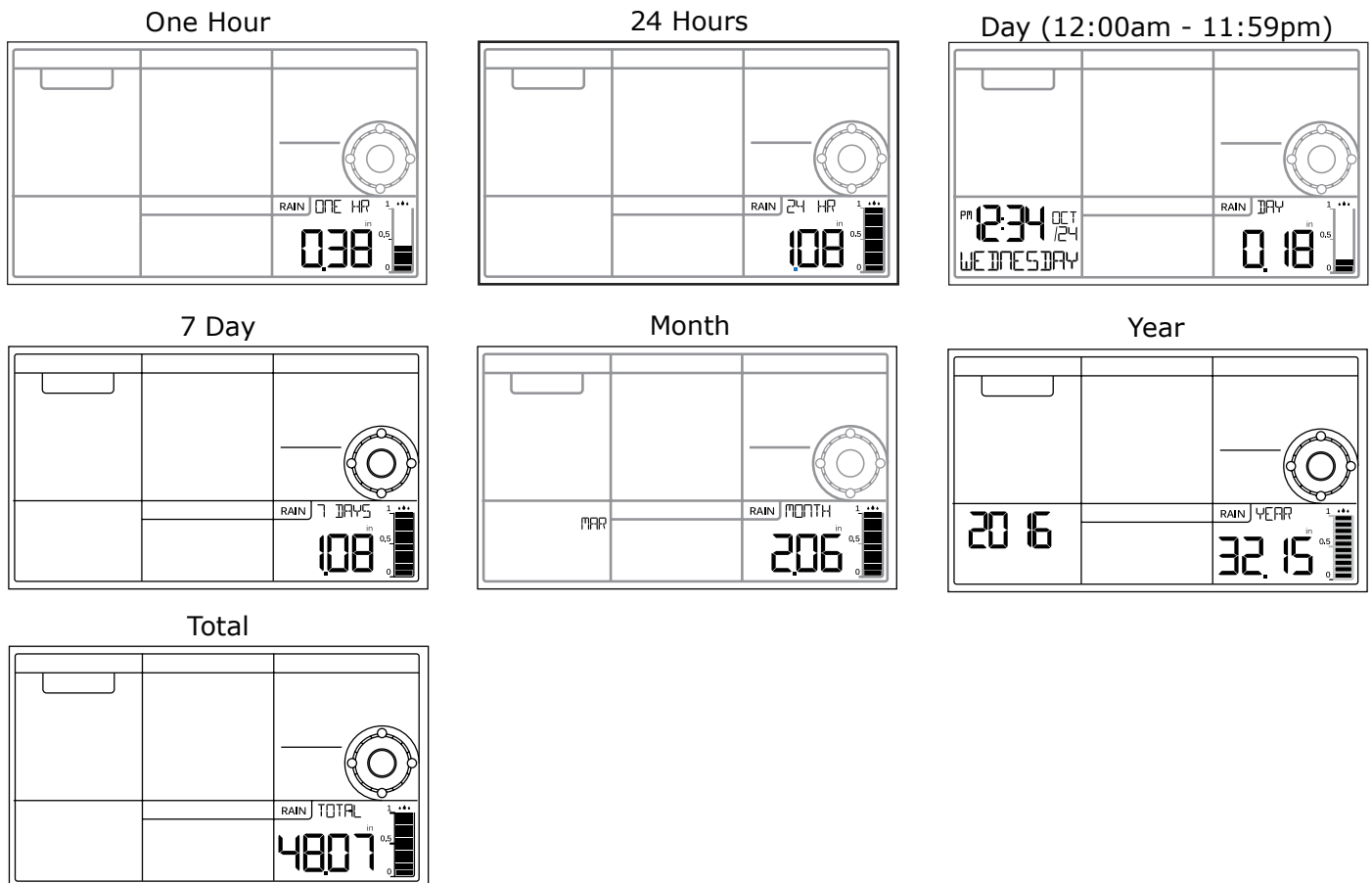

Reset Rainfall Readings (each resets individually):

- Press the RAIN button to view individual rain readings.
- Hold the MINUS button for five seconds to reset the individual value.
- Individual rainfall reading will reset to 0.00

Temperature/Humidity HI | LO Readings

Press and release the TEMP button to view HI/LO temperature and humidity readings with time/date stamp.

- Outdoor temperature HIGH
- Outdoor temperature LOW
- Outdoor humidity HIGH
- Outdoor humidity LOW

- Feels like HIGH
- Feels Like LOW
- Dew Point

- Indoor temperature HIGH
- Indoor temperature LOW
- Indoor humidity HIGH
- Indoor humidity LOW

Note: Feels Like and Dew Point are not time/date stamped.

Outdoor Temp HI

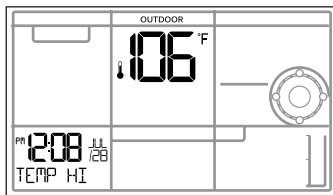

Outdoor Temp LO

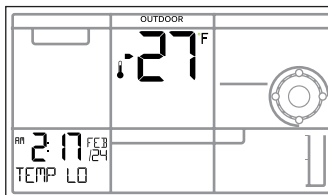

Outdoor Humidity HI

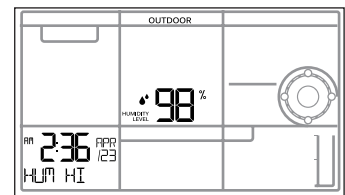

Outdoor Humidity LO

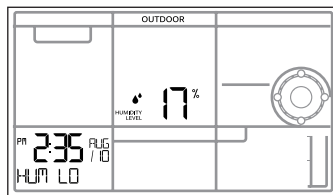

Indoor Temp HI

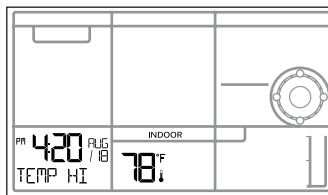

Indoor Temp LO

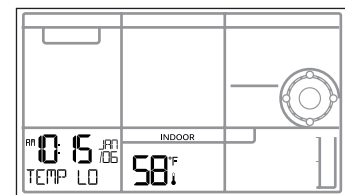

Indoor Humidity HI

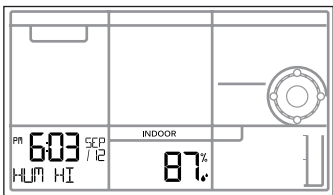

Indoor Humidity LO

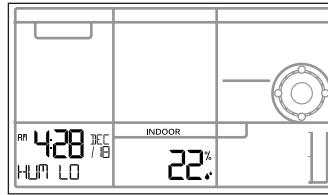

Feels Like HI

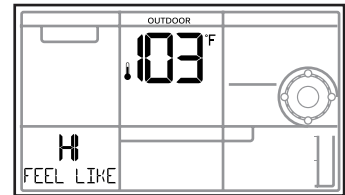

Feels Like LO

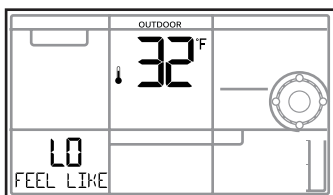

Dew Point

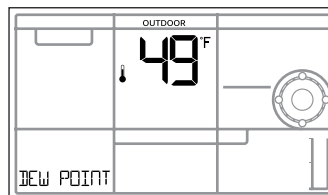

Reset Temperature/Humidity Readings:

- Press the TEMP button to view individual rain readings.
- Hold the MINUS button for five seconds to reset the individual value.
- Individual readings will reset to 0.00

Set Weather Alerts

Hold the ALERTS button for 2 seconds to enter alert set mode. Outdoor Low Temperature alert OFF will show.

Alert ON:

1. Press the +/- buttons to arm the alert.
2. Press the ALERTS button and the alert value will flash
3. Press the +/- buttons to set the alert value (Hold to set quickly).
4. Press ALERTS button to move to next alert.

Alert OFF:

1. Alerts are OFF unless armed. If you do not wish to set an alert, simply press the ALERTS button again to move to the next alert.

Weather Alerts

There are 10 programmable weather alerts on this weather station. Here is the setting order in the alerts menu.

- Outdoor LOW Temperature ON/OFF
- Outdoor LOW Temperature Value -40°F-140°F (-40°C-60°C)
- Outdoor HIGH Temperature ON/OFF
- Outdoor HIGH Temperature Value -40°F-140°F (-40°C-60°C)
- Outdoor LOW Humidity ON/OFF
- Outdoor LOW Humidity Value 10%RH-99%RH
- Outdoor HIGH Humidity ON/OFF
- Outdoor HIGH Humidity Value 10%RH-99%RH
- Indoor LOW Temperature ON/OFF
- Indoor LOW Temperature Value 32°F-122°F (0°C-50°C)
- Indoor HIGH Temperature ON/OFF
- Indoor HIGH Temperature Value 32°F-122°F (0°C-50°C)
- Indoor LOW Humidity ON/OFF
- Indoor LOW Humidity Value 10%RH-99%RH
- Indoor HIGH Humidity ON/OFF
- Indoor HIGH Humidity Value 10%RH-99%RH
- 24-hour Rainfall ON/OFF
- 24-hour Rainfall Value 0-393 inches (0-99.9mm)
- High Wind Speed ON/OFF (CURRENT wind)
- High Wind Speed Value 0-111.8 (0-180kph) (CURRENT wind)

Alert OFF use +/- to arm

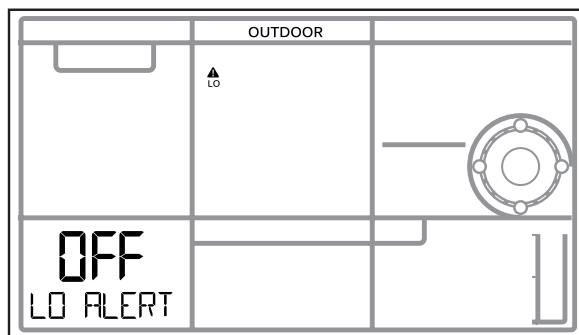

Alert ON use +/- to set value

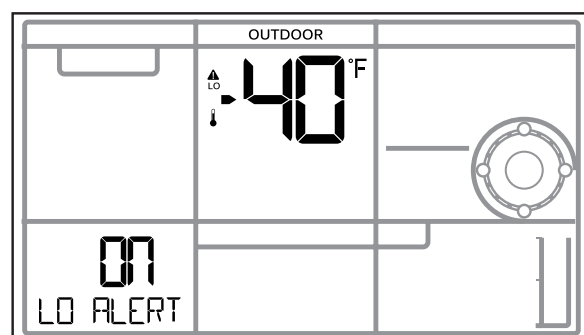

Active Alert

- When armed alert value is reached, station will beep 5 times each minute, until out of alert range.
- The flashing alert icon will indicate if is a LOW or HI alert.
- Press any button to stop the alert sound.
- The alert icon will flash while value is in alert range.

HI  LO

Disarm Alert:

1. Hold the ALERTS button 2 seconds to enter alert set mode.
2. Press and release ALERTS button until you see the alert you wish to disarm.
3. Press the +/- buttons to disarm the alert.
4. Press the LIGHT button to exit.

Alert ON

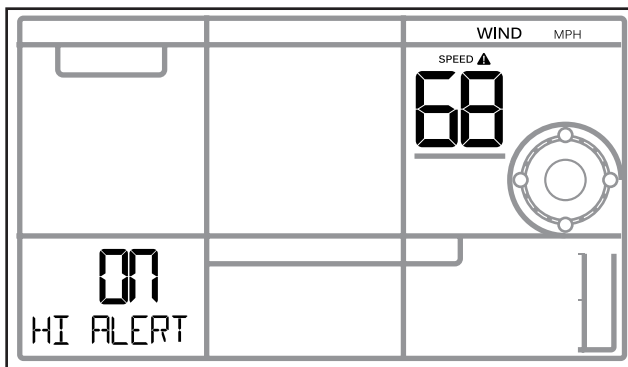

Alert OFF

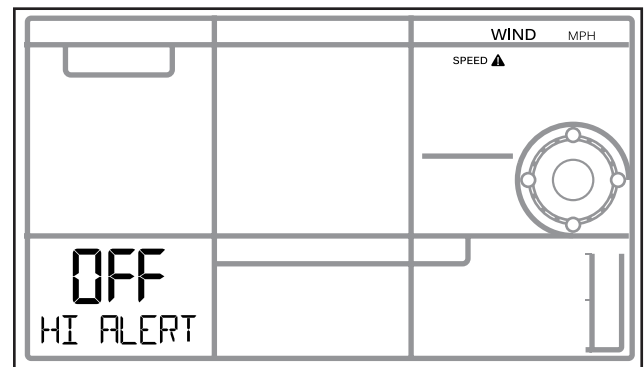

Temperature | Humidity Trend Arrows

- The temperature and humidity trend arrows update every 15 minutes. The trend reflects changes (2°F and 3% humidity) over the past 1 hour. E.g.: At 1:00 - compare to 12:00 data; at 1:15 compare to 12:15: at 1:30 - compare to 12:30 etc



Up Arrow: Risen in past hour



Down Arrow: Fallen in past hour

Forecast Trend Arrows

Forecast trend arrows indicate the rise and fall of barometric pressure.



Up Arrow: Pressure is rising.
Weather will improve.



Down Arrow: Pressure is falling.
Weather may worsen.

Weather Forecast Icons

- The forecast icons are determined by the barometric pressure sensor.
- When Outdoor temperature is below 32°F and the forecast is RAIN or T-STORM, the LCD will display SNOW.

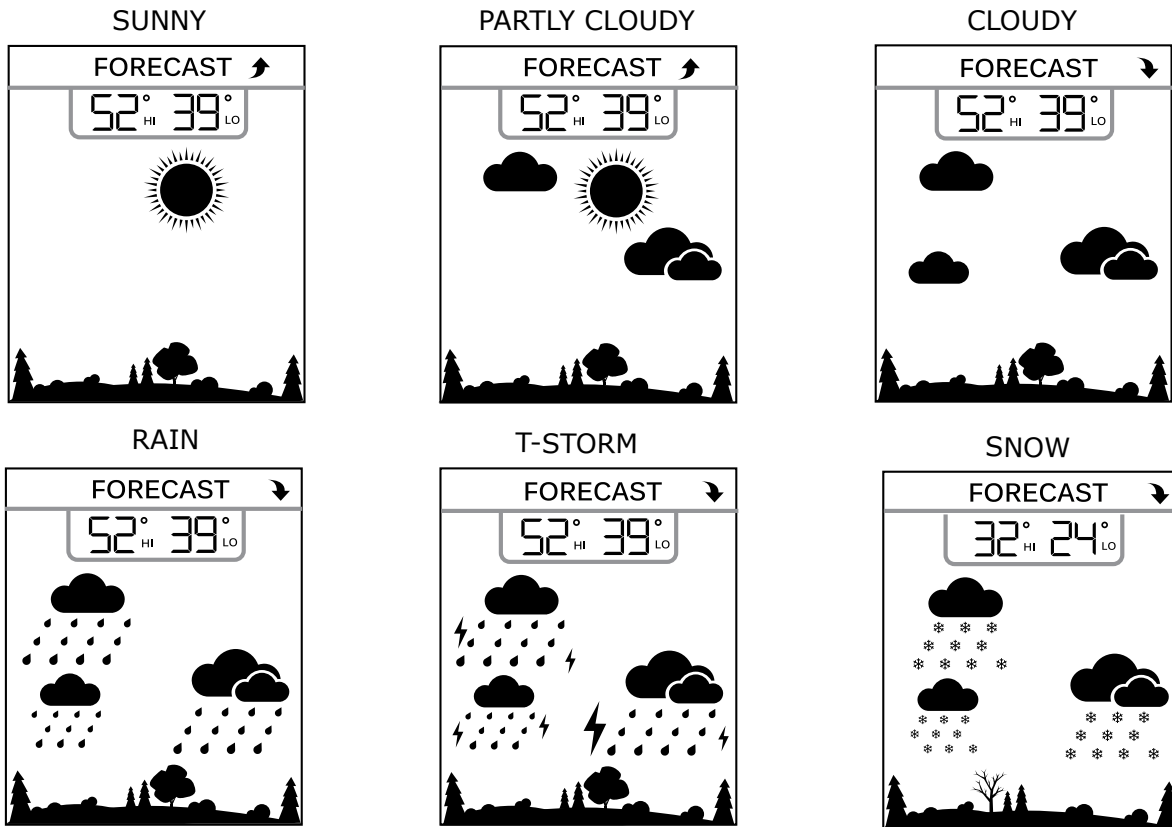

Seasonal Trees

- The trees and foliage color will change seasonally. The dates are programmed into the weather station for the scene to change automatically.

Spring



March 20th – June 20th

Summer



June 21st – Sept. 20th

Autumn



Sept. 21st – Dec 20th

Winter



Dec 21st – Mar 19th

Sensor Search

Each sensor has a unique ID and will be synced to the correct sensor location on the weather station until manually deleted.

- If sensor loses connection to the weather station for any reason, the weather station will show dashes after 30 minutes.
- The weather station will search for 5 minutes every hour to reconnect with sensor.

1. In normal mode press and release the SENSOR button to view individual sensor ID's for up to 15 seconds.
2. Press and release the + button to search for the sensor, who's ID is shown.

TH Sensor ID

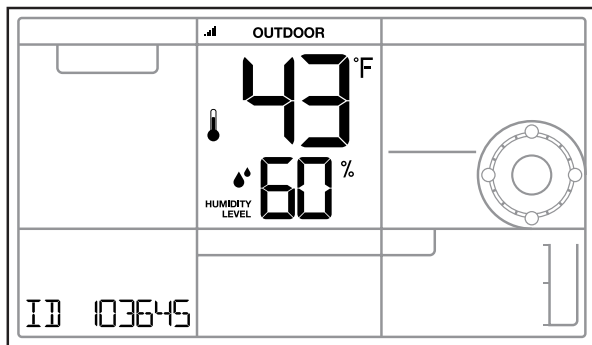

Multi-sensor ID

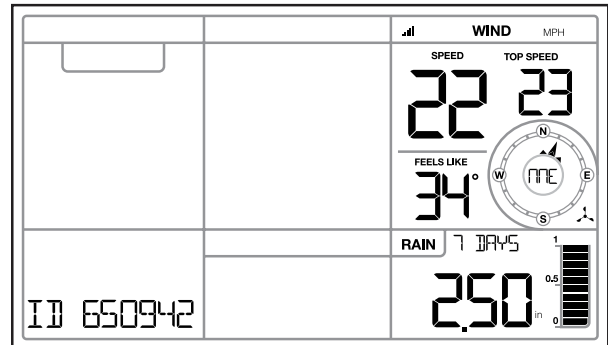

3. The strength signal icon will animate until the sensor signal is received, or for 3 minutes if no signal available.



Delete Sensor:

1. Press the SENSOR button to view individual sensor ID.
2. Hold the - button for 5 seconds to delete the sensor and ID.

Add or Replace Sensor:

1. Install batteries in sensor.
2. Press and release the SENSOR button to view sensor area (dashes).
3. Press the + button to search.
4. Press the TX button on sensor.
5. When sensor connects, its ID and readings will show on the display.

TH Sensor Deleted

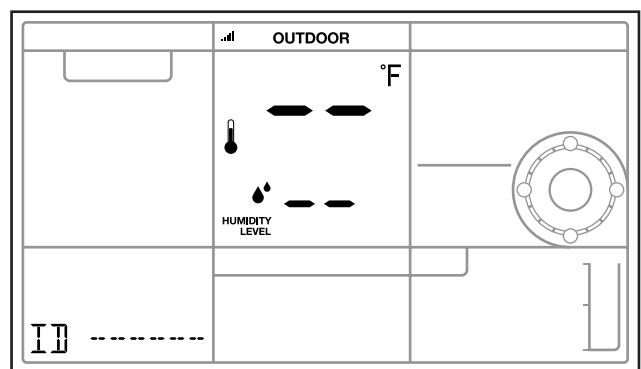

TX233TH Temperature | Humidity

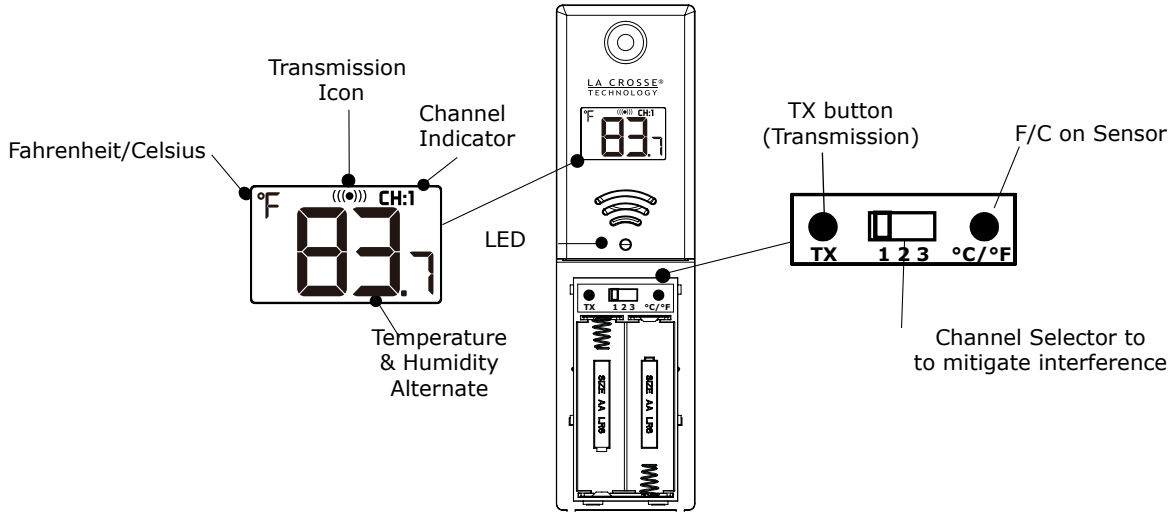

Note: At temperatures below 14°F (-10°C) the sensor display will turn off to protect the LCD. Sensor will still transmit data.

TX233RW Multi sensor

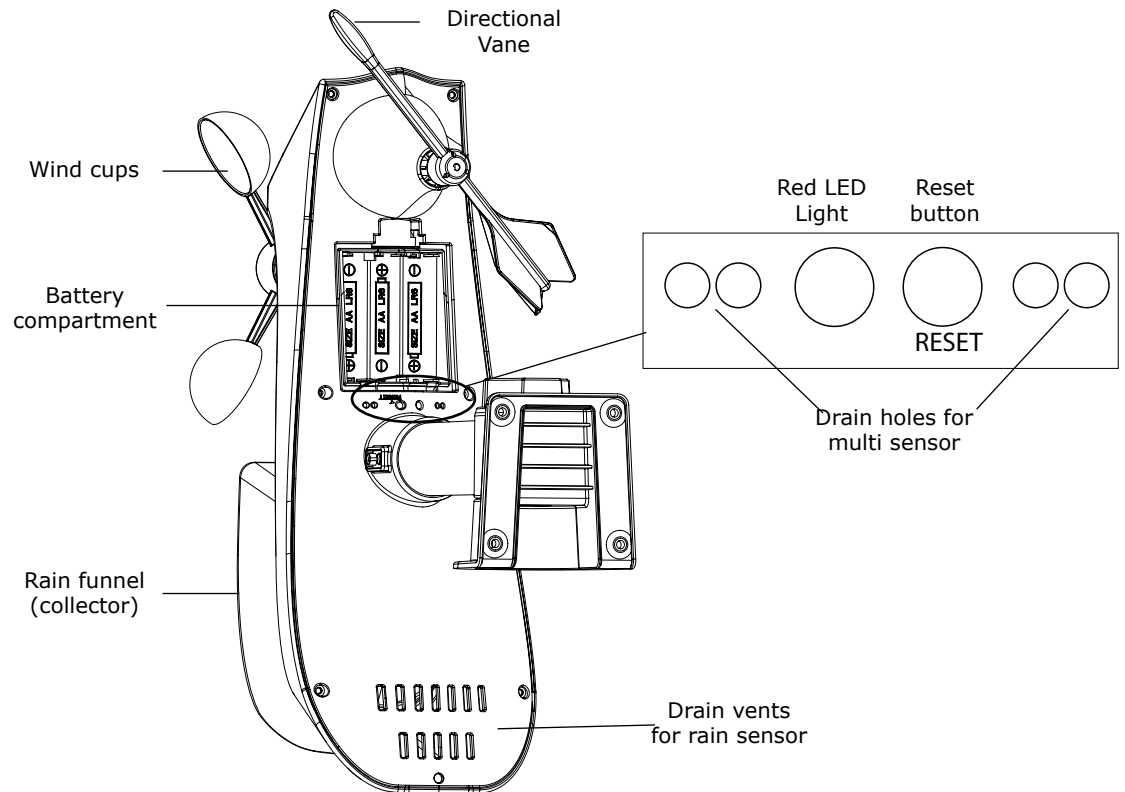

The Multi sensor provides wind speed, wind direction and rainfall readings.

Mounting Instructions

TX233TH Temperature/Humidity Sensor

Option 1:

- Install one mounting screw into a wall.
- Place the transmitter onto the screw.

Option 2:

- Insert the mounting screw through the front of the sensor and into the wall.
- Tighten the screw to snug (do not over tighten).
- Mount the temperature/humidity sensor on a north-facing wall or in any well shaded location. Sun will make it read high.
- Under an eave or deck rail is preferred.
- Be sure the outdoor sensor is mounted vertically to drain moisture.
- The maximum wireless transmission range to the weather station is over 330 feet (100 meters) in open air, not including walls or floors.

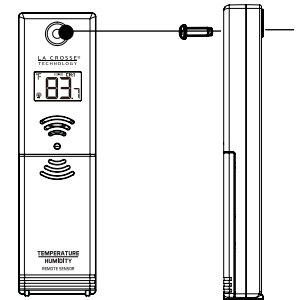
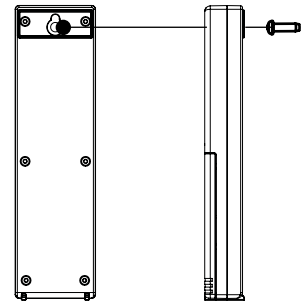

TX233RW Multi-sensor

- Mount in an open area clear for 50 feet in all directions.
- Mount with the solar panel facing south, so the wind direction is correct. See N, S, E W, embossed on the top of the sensor.
- Use the bubble level on the top of the sensor to ensure it is level, for accurate rainfall readings.
- The maximum wireless transmission range to the station is over 330 feet (100 meters) in open air, not including walls or trees.
- Cups should be on the top of the sensor.
- Attach to mounting surface with screws through the mounting bracket.
- The sensor can be mounted from the bottom or from the side.

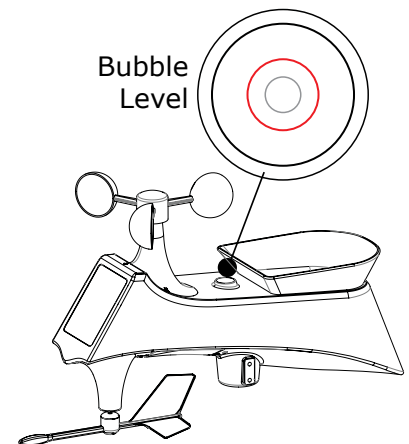

Alternatively:

- Insert your own mounting pole into the sensor base.
- Tighten screws
- Mounting bracket would not be used.

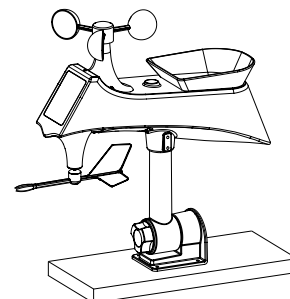
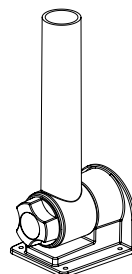
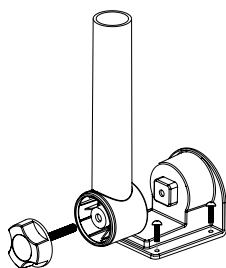

Replace Wind Cups

1. Loosen the screw on side of cups
2. Remove cups
3. Install new cups
4. Tighten screw

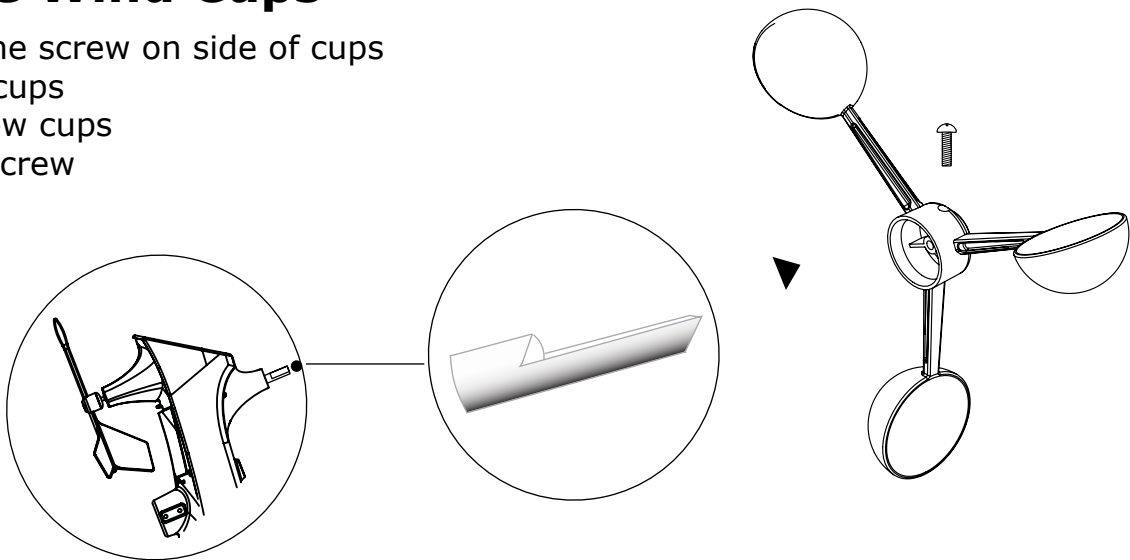

Replace Directional Vane

1. Loosen the screw on side of vane
2. Remove direction vane
3. Install new vane
4. Tighten screw

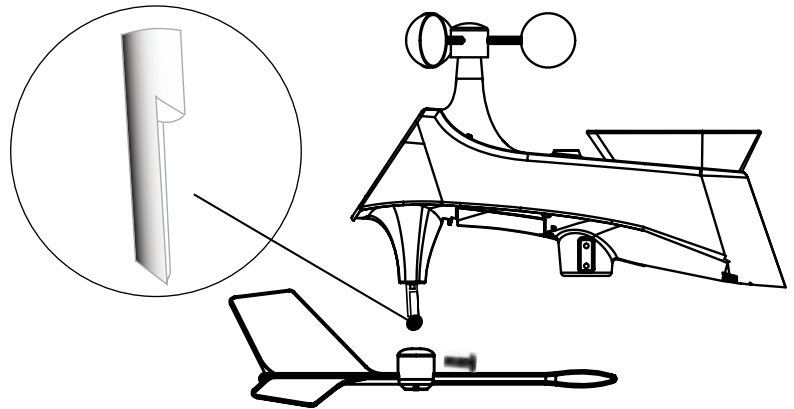

Clean Rain Sensor

1. Remove rain funnel (pull flat side firmly upward).
2. Gently remove debris or insects inside the rain sensor.
3. Clear debris from drain vents.
4. Clear debris from the rain funnel.
5. Reinstall the rain funnel.

Note: Do not oil the rain sensor.

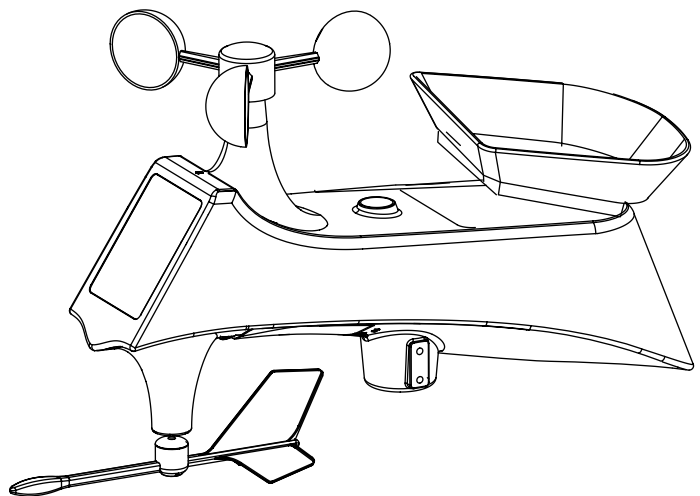

Position Weather Station

1. Wall mount with the two convenient mounting holes on the back of the station.
2. Place station on a surface with the adjustable stand.
 - Stand has two adjustment settings.
 - Flip down the leg extensions for two more viewing angles.

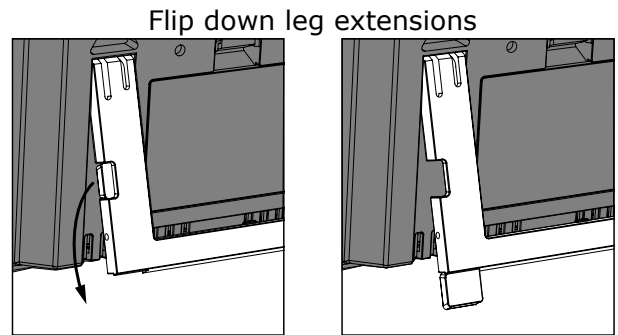
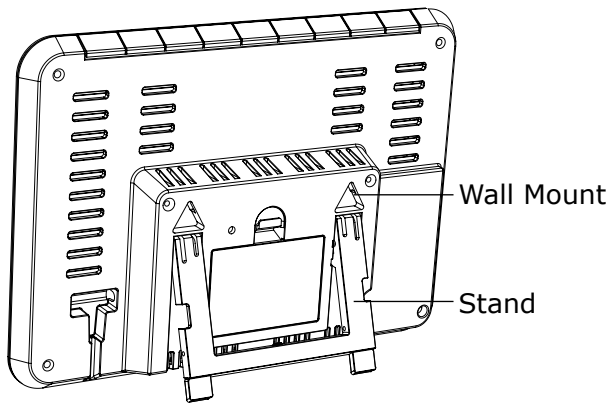

Stand Alone Station

- **Stand Alone:** Receive your backyard Wind, Rain, Temperature and Humidity from your sensors to your color weather station.
- This station operates fully as a stand alone station.

Connected Station

- Use your existing WiFi to connect your weather station to Weather Underground with the Weather Connect App.
- View your backyard weather on your mobile device.
- Invite friends and family to view your weather station information on Weather Underground.
- Time and Date will come from the Internet when connected.

Requirements:

- Weather Underground account with Personal Weather Station (PWS) ID and Password, (you can set this up separately in advance of downloading the Weather Connect App).
- Mobile device with WiFi service (do not use 3G or 4G network)
- High speed Internet service and router

Mobile Application (free available online):

- iOS App Store, search: Weather Connect
- Android Play Store, search: Weather Connect

IMPORTANT:

- The WiFi for your mobile device must be on the same network as your weather station. Check the Wifi setting on your mobile device.
- During setup, weather station and mobile device must be in close proximity.
- Weather station must be powered with AC adapter for the WiFi to work.

Get Connected: Download and Launch the Weather Connect App and follow the on-screen instructions. App will prompt for required information.



Weather Connect



Note: The Weather Connect App is only for connecting your weather station to Weather Underground

Note: Weather Underground will show your station's information on their website.

- In addition they have an App you can download to view your backyard weather on your mobile device without opening your browser.
- Download the Weather Underground App and search for your weather station with your Personal Weather Station (PWS) ID number.
- Weather Underground can take up to 24 hr. to start showing your weather station's data on the Weather Underground App (Your station will show on their website sooner).

Tips:

- For your security, this app will **only** work on protected WiFi networks.
- Open public networks that require a browser sign in will not work.

Lost connection:

- If WiFi signal or power to the station is lost, hold the PLUS and MINUS buttons together for 3 seconds to reconnect to the same WiFi network.

Never connected: If the station has not uploaded its data to Weather Underground try:

- First, move the station and mobile device to a different network, and check to be sure it is a protected WiFi network.
- Complete a Factory Restart to clear the station.

Factory Restart: Hold the LIGHT and ALERTS buttons together for 5 seconds until the station resets. For more information on the factory reset, see page 20.

Snowbirds:

If you have been using the app to view your weather at your summer home. When you move the station and sensors to your winter home, reconnect your app through the WiFi network at your new location.

1. Start the Weather Connect app and enter the password for the new WiFi network.
2. Hold the PLUS and MINUS buttons on the station for 3 seconds to search for the network.
3. Enter Weather Underground station ID and password.

WiFi Icon

- The WiFi icon will flash while station is searching for WiFi connection.
- It will flash up to 1 hour before stopping due to no connection opportunity.
- The station must operate on AC power for the WiFi to work.



Slow Flash - No WiFi network connection-check connection

Fast Flash - Configure Weather Connect App

Solid - WiFi Connected to Internet

(**Note:** Does not indicate connection to Weather Underground, only that station is connect to the Internet via Weather Connect App).

Not displayed -Not connected to WiFi router-check router

Visit Us on Social Media



Latest video content

http://bit.ly/LaxTech_YouTube



For personalized interaction

http://bit.ly/LaxTech_Facebook



Join the conversation

http://bit.ly/LaxTech_Twitter



Pin and share

http://bit.ly/LaxTech_Pinterest

Factory Restart

The factory reset will return the weather station to its default settings.

IMPORTANT: This will clear all previous recorded history, so you may want to write down data before taking this step.

1. Bring the Multi-sensor and Thermo-hygro sensor in close to the weather station.
2. Hold the **LIGHT** and **ALERTS** buttons together for 5 seconds to reset the weather station, clear all records, and return all settings to default.
2. The weather station will fully populate, then return to a normal display and search for outdoor sensors.
3. While searching for the outdoor sensors the Wind Speed, Outdoor Temperature/Humidity and Rainfall totals will show dashes.
4. Once connected to the outdoor sensors (allow 3 minutes) the Wind Speed, Outdoor Temperature/Humidity, and Rainfall will show current readings.

Care and Maintenance

- Do not mix old and new batteries
- Do not mix Alkaline, Standard, Lithium or Rechargeable Batteries
- Always purchase the correct size and grade of battery most suitable for intended use.
- Replace all batteries of a set at the same time
- Promptly remove expired batteries.

Warranty and Support

La Crosse Technology, Ltd. provides a 1-year limited time warranty (from date of purchase) on this product relating to manufacturing defects in materials & workmanship. Before returning a product, please contact our friendly customer support with questions or visit our online help:

Phone: 1-608-785-7921

Online Product Support and Registration: www.lacrossetechnology.com/support

View full warranty details online at: www.lacrossetechnology.com/warranty_info.pdf

Specifications

Indoor

Temperature Range	32°F to 99°F (0°C to 37°C)
Humidity Range	10% to 99% RH
Update Interval	About every 60 seconds

Thermo-hygro Sensor

Temperature Range	-40°F to 140°F (-40°C to 60°C)
Humidity Range	10% to 99% RH
Update Interval	About every 58 seconds
Transmission Range	330 feet (100 meters) RF 915MHz

Multi-sensor

Wind Speed Range	0-111.8 mph (0-180 kmh)
Wind Direction Range	0 to 359 degrees
Rainfall	0-393.7 inches (0-9999 mm)
Update Interval	About every 30 seconds
Transmission Range	330 feet (100 meters) RF 915MHz

WiFi

Transmission Range	80 feet (24 meters) RF 2.4 GHz
---------------------------	--------------------------------

Power

Weather Station	5.0 Volt 500mA adapter included (Primary) AC6: HX06-0500500-AU Optional: 3-AAA, IEC, LR3 batteries (not included)
TX233RW Multi-sensor	3-AA, IEC, LR6 batteries (not included)
TX233TH Thermo-hygro	2-AA, IEC, LR6 batteries (not included)

Battery Life

Weather Station	48-60 months when using adapter
TX233RW Multi-sensor	over 24 months with reputable batteries
TX233TH Thermo-hygro	over 24 months with reputable batteries

Dimensions

Weather Station	8.05" W x 5.70" H x 1.36" D in (204.47 W x 144.78 H x 34.54 D mm)
TX233RW Multi-sensor	13.61" W x 8.55" H x 5.14" D (345.69 W x 217.17 H x 130.55 D mm)
TX233TH Thermo-hygro	1.67" W x 6.14" H x 0.83" D (42.42 W x 155.96 H x 21.08 D mm)

FCC Statement

This equipment has been tested and found to comply with the limits for a Class B digital device, pursuant to part 15 of the FCC Rules. These limits are designed to provide reasonable protection against harmful interference in a residential installation. This equipment generates, uses and can radiate radio frequency energy and, if not installed and used in accordance with the instructions, may cause harmful interference to radio communications. However, there is no guarantee that interference will not occur in a particular installation.

If this equipment does cause harmful interference to radio or television reception, which can be determined by turning the equipment off and on, the user is encouraged to try to correct the interference by one or more of the following measures:

- Reorient or relocate the receiving antenna.
- Increase the separation between the equipment and receiver.
- Connect the equipment into an outlet on a circuit different from that to which the receiver is connected.
- Consult the dealer or an experienced radio/TV technician for help.

This device must not be co-located or operating in conjunction with any other antenna or transmitter.

Operation is subject to the following two conditions:

- (1) This device may not cause harmful interference, and
- (2) This device must accept any interference received, including interference that may cause undesired operation.

Caution!

The manufacturer is not responsible for any radio or TV interference caused by unauthorized changes or modifications to this equipment. Such changes or modifications could void the user authority to operate the equipment.

This equipment must be installed and operated in accordance with provided instructions and the antenna(s) used for this transmitter must be installed to provide a separation distance of at least 20 cm from all persons and must not be co-located or operating in conjunction with any other antenna or transmitter

All rights reserved. This manual may not be reproduced in any form, even in part, or duplicated or processed using electronic, mechanical or chemical process without the written permission of the publisher. This booklet may contain errors or misprints. The information it contains is regularly checked and corrections are included in subsequent editions. We disclaim any responsibility for any technical error or printing error, or their consequences.

All trademarks and patents are recognized.

Canada Statement

This device complies with Industry Canada's licence-exempt RSSs

Operation is subject to the following two conditions:

- (1) This device may not cause interference; and
- (2) This device must accept any interference, including interference that may cause undesired operation of the device.

Le présent appareil est conforme aux CNR d'Industrie Canada applicables aux appareils radio exempts de licence.

L'exploitation est autorisée aux deux conditions suivantes :

- (1) l'appareil ne doit pas produire de brouillage;
- (2) l'utilisateur de l'appareil doit accepter tout brouillage radioélectrique subi, même si le brouillage est susceptible d'en compromettre le fonctionnement.

The device meets the exemption from the routine evaluation limits in section 2.5 of RSS 102 and compliance with RSS-102 RF

exposure, users can obtain Canadian information on RF exposure and compliance.

Le dispositif rencontre l'exemption des limites courantes d'évaluation dans la section 2.5 de RSS 102 et la conformité à l'exposition de RSS-102 rf, utilisateurs peut obtenir l'information canadienne sur l'exposition et la conformité de rf.

This equipment must be installed and operated in accordance with provided instructions and the antenna(s) used for this transmitter must be installed to provide a separation distance of at least 20 cm from all persons and must not be co-located or operating in conjunction with any other antenna or transmitter

This transmitter must not be co-located or operating in conjunction with any other antenna or transmitter. This equipment should be installed and operated with a minimum distance of 20 centimeters between the radiator and your body.

Cet émetteur ne doit pas être Co-placé ou ne fonctionnant en même temps qu'aucune autre antenne ou émetteur.

Cet équipement devrait être installé et actionné avec une distance minimum de 20 centimètres entre le radiateur et votre corps.