

RIGGING CATALOGUE



VANGUARD STEEL LTD.



This is

VANGUARD STEEL LTD.

at your service

Since 1960, Vanguard Steel Ltd., a sister Company of Ringball Corporation, has been supplying specialty steels and steel products to North American Industries.

By representing some of the most reputable manufacturers around the Globe, Vanguard's various Product Divisions offer a wide range of North American, European and Asian products, many of which are being manufactured to Vanguard's own specifications and often exceed Industry Standards.

Besides office and warehousing facilities throughout Canada, Vanguard Steel relies on a vast network of Canadian and U.S. Distributors to assure local product availability and best possible service.



VANGUARD'S PRODUCT DIVISIONS:

- **SPECIALTY STEELS**
- **WIRE ROPES, CABLES AND RELATED HARDWARE**
- **CHAINS AND ACCESSORIES**
- **BUILDER'S HARDWARE**
- **INDUSTRIAL KNIVES**
- **ABRASIVES**
- **WELDING CONSUMABLES**

WAREHOUSE LOCATIONS

VANGUARD'S OFFICE & WAREHOUSE LOCATIONS:



TORONTO (Head Office):
2160 Meadowpine Blvd.
Mississauga, ON L5N 6H6
(905) 821-1100
Fax. (905) 821-2024
toronto@vanguardsteel.com



TORONTO (Specialty Steel Div.):
2210 Meadowpine Blvd.
Mississauga, ON L5N 6H6
(905) 821-1100
Fax. (905) 821-1102
steelsales@vanguardsteel.com



MONTREAL:
2205 de l'Aviation
Dorval, QC H9P 2X6
(514) 685-1515
Fax. (514) 685-1516
montreal@vanguardsteel.com



EDMONTON:
7606 McIntyre Rd. NW
Edmonton, AB T6E 6Z1
(780) 466-1115
Fax. (780) 469-4545
edmonton@vanguardsteel.com



WINNIPEG:
190 Omands Creek Blvd.
Winnipeg, MB R2R 1V7
(204) 694-2259
Fax. (204) 633-7230
winnipeg@vanguardsteel.com



VANCOUVER:
7880 Fraser Park Dr.
Burnaby, BC V5J 5L8
(604) 294-3191
Fax. (604) 294-8845
vancouver@vanguardsteel.com



WARNINGS

- General Warnings ...6
- Standards ...6
- Working Load Limit (WLL) ...6

WIRE ROPES & CABLES

- General Information ...8
- Wire Rope Cores ...8
- Finishes ...8
- Wire Rope Lay ...9
- Other Considerations ...9
- Rope Construction ...10
- Small Diameter Cables ...11,12
- 7 x 7 x 7 Cable Laid IWRC Galvanized ...13
- Hose Restraints ...13
- 1 x 7 Galvanized Guy Strand ...14
- 6 x 19 Classification ...15
- 6 x 36 Classification ...16
- 19 x 7 Classification IWRC ...17
- 6 x 26 Swaged and Super Swaged IWRC ...18
- Tower King 12 1960 RLL ...19
- VPC 10P 1960 RLL ...20
- 3 x 7 Swaged Wire Rope IWRC ...21
- 1 x 19 Armored Cable ...21

WIRE ROPE HARDWARE

- Wire Rope Clip Warnings and Information ...24
- Malleable Wire Rope Clips ...25
- Stainless Steel Wire Rope Clips ...25
- 'Golden U-Bolt'® Forged Wire Rope Clips ...26
- 'Golden U-Bolt'® Efficiency Rating ...27
- Shackles Warnings and Information ...28, 29
- 'Golden Pin'® Screw Pin Anchor Shackles ...30
- 'Golden Pin'® Bolt Type Pin Anchor Shackles ...31
- 'Golden Pin'® Screw Pin Chain Shackles ...32
- Galvanized Screw Pin Anchor Shackles ...33
- Stainless Screw Pin Anchor Shackles ...34
- 'Black Eye'® Hoist Hooks ...35
- 'Black Eye'® Swivel Hooks ...35
- Stainless & Alloy Latch Kits ...35
- Standard Wire Rope Thimbles ...36
- Heavy Wire Rope Thimbles ...36
- Stainless AN - Thimbles ...37
- Oval Sleeves ...37
- Stop Sleeves ...37
- Forged Eye Bolt Warnings and Information ...38, 39
- Shoulder Nut Eye Bolts ...40
- Regular Nut Eye Bolts ...41
- Machined Eye Bolts ...42
- Screw Eye Bolts ...43
- Forged Eye Nuts ...43
- Forged Eye & Eye Swivels ...44
- Forged Jaw & Eye Swivels ...44

- Swivel Hoist Rings ...45
- Eye & Eye Forged Turnbuckles with Locknuts ...46
- Hook & Hook Forged Turnbuckles with Locknuts...47
- Jaw & Jaw Forged Turnbuckles with Locknuts ...48
- Forged Turnbuckle Bodies ...49
- Forged Stub End Turnbuckles ...49
- Weldless Pear Shaped Links ...50
- Wire Rope Sheaves ...50
- Snatch Blocks Warnings and Information ...51
- Snatch Blocks ...52
- Load Calculation Table ...52
- Yarding Blocks ...53
- FX Yarding Blocks ...53
- Gin Blocks ...54
- Pulley Blocks ...54
- SK 05 Korean Type Blocks ...55
- Roller Shackles ...55
- Impact Cutters ...56
- Felco® Cutters ...57, 58
- Felco® Standard Spare Parts Listing ...59, 60
- Swaging Tools ...61
- Swaging Instructions ...62
- Flemish Eye Sleeves ...63
- Bolt Cutters ...64
- Tire Chain Pliers ...64
- Tire Chain Tensioners ...64

CHAIN

- Tenso/Lion Chain (Double Loop) ...66
- Single Jack Chain ...66
- Grade 30 Long Link Mooring Chain ...67
- Straight Link Coil Chain ...67
- Passing Link Chain ...67
- T-316 Stainless Steel Chain ...68
- Titan Anti-Theft Security Chain ...68
- Grade 30 Chain Exact ...69
- Grade 30 Exact Size ...69
- Grade 40 Chain ...69
- NACM Chain Specifications ...70

CHAIN ACCESSORIES

- 'Gold Pin'® Clevis Grab Hooks - Carbon Steel ...71
- 'Black Pin'® Clevis Grab Hooks - Alloy Steel ...71
- 'Gold Pin'® Clevis Slip Hooks - Carbon Steel ...71
- 'Black Pin'® Clevis Slip Hooks - Alloy Steel ...72
- Eye Grab Hooks - Carbon Steel ...72
- Eye Slip Hooks - Carbon Steel ...72
- Quick Links ...73
- Pear Shaped Snap Hooks ...73
- 'S' Hooks ...74
- Twin and Double Clevis Links ...74
- Cold Shuts ...75
- Lap Links ...75

TABLE OF CONTENTS

V-LINE CHAIN & ACCESSORIES

• V-Line Warnings and Information	...76
• Gr 80 & 100 Chain Sling Load Chart	...77
• Component Selection Guide	...78
• V-Line Grade 80 Chain	...79
• V-Line Grade 100 Chain	...79
• Gr. 80 Alloy Master Links	...80
• Gr. 80 Alloy Sub-Assemblies	...80
• Gr. 80 Alloy Master Link with Flat Spot	...81
• Gr. 80 Coupling Links	...81
• Gr. 80 Clevis Grab Hooks	...82
• Gr. 80 Clevis Sling Hooks	...82
• Gr. 80 Self Locking Clevis Hooks	...83
• Gr. 80 Self Locking Eye Hooks	...83
• Gr. 80 Self Locking Swivel Hooks	...84
• Gr. 100 Alloy Master Links	...85
• Gr. 100 Alloy Sub-Assemblies	...85
• Gr. 100 Coupling Links	...86
• Gr. 100 Clevis Grab Hooks	...86
• Gr. 100 Clevis Sling Hooks	...87
• Gr. 100 Self Locking Clevis Hooks	...87
• Gr. 100 Self Locking Eye Hooks	...88
• Gr. 100 Self Locking Swivel Hooks	...88
• Sling Identification Tags	...89
• Standard Spare Parts List	...89

CARGO CONTROL PRODUCTS

• Load Binders Warnings & Information	...92
• Recoilless Load Binders	...93
• Ratchet Type Load Binders	...93
• Lever Type Load Binders	...94
• Load Binder Locks	...94
• Load Tighteners	...94
• Grade 70 Transport Chain	...95
• Tags For Grade 70 Chain and Assemblies	...95
• 18" Chain Tails - Grade 70	...96
• Grade 70 Tie Down Assemblies	...96
• 'AG'-Type Grade 70 Clevis Grab Hook	...96
• 'Black Pin'® Clevis Slip Hooks - Alloy Steel	...97
• 'Black Pin'® Clevis Crab Hooks - Alloy Steel	...97
• Ratchet Buckles	...98
• Overcentre Buckles	...99
• Cam Buckles	...100
• Closed Hooks	...101
• Vinyl Covered Hooks	...101
• Flat Hooks	...102
• Narrow Wire Hooks	...102
• Standard Sliding Winches	...103
• 2" Lashing Winch	...104
• Ratchet Gear Hand Winch	...105
• Worm Gear Hand Winch	...105
• Winch Bars	...106
• Corner Protectors for Chain & Webbing	...106

• D-Rings with Weld-On Hinges	...107
• Tarp Tie-Down Straps	...108
• Chrome Plated Hitch Balls	...108

MATERIAL HANDLING

• VQ Super Series Manual Lever Hoists	...110
• Parts for VQ Super Series	...111
• Gold Series Manual Lever Hoists	...112
• Parts for Gold Series Lever Hoists	...113
• Type-1 Heavy Duty Manual Lever Hoists	...114
• Parts for Type-1 Lever Hoists	...115
• Gold Series Chain Hoists	...116
• Parts for Gold Series Chain Hoists	...117
• Type-1 Heavy Duty Manual Chain Hoists	...118
• Parts for Type-1 Chain Hoists	...119
• Push Trolleys	...120
• Beam Clamps	...121
• VH Cable Pullers	...122
• Cable Assembly	...122
• VCT-B Swivel Style Cargo Trolley	...123
• Handles for VCT-B Swivel Style Cargo Trolley	...123
• Polyurethane Wheels	...123
• Drum Lifters	...124

BUILDER'S HARDWARE

• Nails	...126...127
• Forming Stakes	...128
• Anchor Bolts	...128
• Annealed Wire	...129
• Stainless Steel Lashing Wire	...130
• Rebar Tie Wire	...130
• Rebar Tie Wire Dispenser	...130
• Tie Wire Loops	...131
• Straight Cut Annealed Wire	...131
• Tie Wire Twisting Tool	...132
• Automatic Twisting Tool	...132
• Hardware Cloth	...133
• Poultry Netting	...134
• Steel Strapping	...135
• Dispensers for Steel Strapping	...135
• Tools for Steel Strapping	...136
• Steel Seals for Steel Strapping	...136
• T-Posts	...137
• T-Post Pounder	...137

SLINGS

• 'Golden Eye' Wire Rope Lifting Slings	...140
• Wire Rope Lifting Slings	...141
• Polyester Lifting Slings with Edge Guard	...142
• Polyester Lifting Slings - Type 5	...143
• Polyester Endless Round Slings	...144, ...145
• Warnings and Information	...146



WARNING

General Warnings

All Vanguard rigging products are sold with the express understanding that both the purchaser and the end user are thoroughly familiar with the safe, proper and acceptable applications of the products.

It is the responsibility of the end user to establish proper safety programs and to provide thorough training for all personnel prior to use. The training programs must meet any federal/provincial/state/local code requirements, existing plant/site safety rules and regulations, and all instructions provided in the applicable section of this catalogue.

Product failure can occur due to abuse, misapplication, lack of maintenance, use by unqualified personnel and improper inspection prior to use. **Any failure of rigging products may result in property damage, personal injury and even death!!!!**

Standards

There are numerous government and industrial standards that cover rigging products. This catalogue makes no attempt to reference all of them; it references to the standards that are most frequently asked about.

Working Load Limit (WLL) – Safe Working Load (SWL)

The Working Load Limits shown in this catalogue are applicable to products that are new or “in as new” condition. The Working Load Limits ratings refer to the maximum amount of force or load that the rigging product can carry under normal working/environmental conditions.

The Working Load Limits and Design Factory can be affected by wear, misuse, overloading, shock loading, side loading, corrosion, deformation, product alteration and other use conditions. Inspection of rigging products prior to use is required to determine whether the product continues to meet the assigned WLL provided in this catalogue, should be used at a reduced rating or removed from service.

The WLL rating must never be exceeded!!!!

WIRE ROPES & CABLES



VANGUARD STEEL LTD.

GENERAL INFORMATION

Vanguard Steel's Wire Rope and Hardware Division acts as a Wholesale Distributor of Wire Ropes and Rigging Hardware, catering predominantly to Industrial Distributors and Rigging Shops.

By offering North American designed products which are manufactured to Vanguard's specifications by the most economical and reputable global manufacturing base, Vanguard offers great value to its customers. Rather than seeking to position Vanguard as an importer of cheap products for which price considerations override any quality concerns, Vanguard will continue to compete directly against other 'top-of-the-line' brand names in the wire rope fabricating and rigging field.

WIRE ROPE CORES

The core forms the heart of the rope and is the component around which the main strands are laid. The core supports the strands and is intended to keep them from jamming against or contacting each other under normal loads and flex. The most popular core constructions are the following:

Fiber Core (FC):

These cores can be made from natural or synthetic fibers. The majority of Vanguard's Fiber Core ropes feature a Polypropylene Core (PPC), as they are less susceptible to compacting (especially under moist conditions) and are impervious to many acids.

Independent Wire Rope Core (IWRC):

IWRC ropes are used in applications requiring maximum strength, resistance to crushing and all applications for which fiber core ropes are not suitable (i.e. excessive heat of 250° F or greater).

Strand Core (SC):

This type of core would only be chosen for applications where 'stiffness' of the rope is not a drawback but is, in fact, desirable.



Fiber Core



Strand Core



Independent Wire Rope Core

FINISHES

To protect against friction and corrosion, proper lubrication of individual wires and strands plays an important role in the production of wire rope. Additional field lubrication may be required if the ropes are subjected to heavy usage or lengthy storage. The type of lubrication depends on the intended usage of the rope:

- Type A-1 & A-2:** Vaseline based lubricant, for light and medium duty applications
- Type B:** Petroleum based lubricant, for more severe applications (i.e. construction)
- Type C:** Asphalt based lubricant, often specified for non-rotating ropes

For additional protection against premature corrosion, the individual wires of an uncoated rope (generally referred to as 'bright' or 'black') are hot dip galvanized at finished size. This will, however, reduce the breaking strength of the rope by approximately 10% from a comparable bright rope.

Where wire ropes are subject to severe corrosive elements such as salt water, various acids, etc., stainless steel ropes may have to be considered.

WIRE ROPE LAY

The term 'rope lay' signifies the direction of rotation of the wires and the strands in the rope. Rotation is either:

- Right Lay** - Clockwise, or
- Left Lay** - Counter-clockwise



Right Lang Lay (RLL)

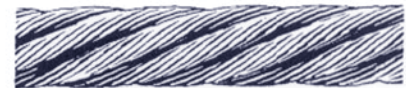

Left Lang Lay (LLL)

Regular Lay:

Wires in strands are laid in one direction, while the strands in the rope are laid in the opposite direction. This results in wire crown running approximately parallel to the longitudinal axis of the rope. These ropes are stable, have good resistance to kinking and twisting, and are easy to handle. They are also able to withstand a considerable amount of 'crushing' and 'distortion' due to the short length of exposed wires.

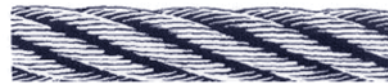

Right Lay Regular Lay (RRL)

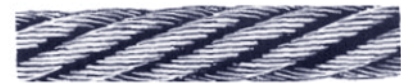

Left Lay Regular Lay (LRL)

Lang Lay:

Wires are laid in the same direction as the strands of the rope, and in an angle to the rope axis. With the outer wires presenting greater wearing surfaces, these ropes have greater resistance to abrasion than regular lay ropes. They are also more flexible and possess greater fatigue resistance. Lang Lay ropes should have both ends permanently fixed to prevent untwisting. They are not recommended for use on single part hoist-lines, nor should they be used with swivel end terminals.

OTHER CONSIDERATIONS:

Stretch:

There are two types of stretch that occur in wire ropes:

Constructional Stretch:

This is a permanent elongation that takes place due to a slight lengthening of the rope lay, compression of the core and adjustment of the wires and strands to the load. Constructional stretch varies with the severity of the operation and generally occurs during the first weeks of operation. It increases the length of the rope by approximately 1/2 % for fiber core ropes and 1/4 % for steel core ropes.

Elastic Stretch:

This is a recoverable elongation similar to the stretch in a rubber cord. If the load is kept within the elastic limit of the rope, the theory of elastic materials will apply.

Shifting Points of Wear:

Wear and fatigue usually take place at certain definite points along a rope. Removing short lengths from the drum end of the rope shifts these wear points and exposes relatively unworn sections of the rope to the harder working areas. To take advantage of this method of increasing service life, it is obviously necessary to initially order a slightly longer rope length than required.

Turning Rope End for End:

On many installations, destructive forces are more severe along one half of the rope than the other. By turning the rope end for end, it is possible to increase its service life.

Measuring Wire Rope:

The diameter of a wire rope is the diameter of the circle which encloses all the wires. When measuring wire rope, it is important to take the greatest distance of the outer limits of the 'crowns' of two opposite strands. A measurement across the valleys will result in incorrect (lower) readings.

**ROPE CONSTRUCTIONS:****Small Diameter Cables:**

Ranging in diameters up to 3/8", the construction, material and finish of these cables depends on their ultimate use:

1. Commercial quality cables (often referred to as aircraft cables but not for use in aircraft!)
2. Control cables (used in the automotive industry)
3. Conveyor belt cables

Engineering & General Purpose Wire Ropes:

The construction of wire ropes and strands covered under this heading varies within specific Classifications and will depend on the desired performance features, such as flexibility, resistance to abrasion, resistance to rotation, etc.:

1 x 7 Classification (Guy Strand)**6 x 7 Classification**

Used where ropes are dragged over the ground or over rollers and where resistance to abrasion is an important factor. The large outer wires will withstand a great deal of wear at the expense of flexibility.

6 x 19 Classification

Constructions falling under this classification are the most widely used throughout all industries, as they feature a good balance between abrasion resistance and flexibility.

6 x 37 Classification

Increasing the number of wires while reducing the wire diameter results in greater flexibility but diminishes abrasion resistance.

19 x 7 Classification

Due to their rotation resistance characteristics, ropes falling under this classification are being used for many hoisting applications, but failure to easily detect damage to the inner core is among the reasons that usage has declined in favour of Specialty Ropes.

8 x 19 Classification

Reverse bends and small sheaves may render 8 strand ropes a better choice than 19 x 7 or other rope constructions.

Specialty Ropes

For applications where performance, down-time and/or safety considerations outweigh a rope's cost of acquisition, a wide range of specialty ropes has been developed. Proper selection, handling and installation of such ropes is essential in maximizing results.

WIRE ROPES & CABLES

SMALL DIAMETER CABLES

- Manufactured to the latest US Military Specifications
- Designed for industrial and marine applications



1 x 19 Construction

Designed primarily for standing rigging on boats, bracing and other applications where the stiffness of a strand is preferable to the flexibility of the cable



7 x 7 Construction

Generally used for small diameters. Less flexible than 7 x 19 construction, but it offers better abrasion resistance.

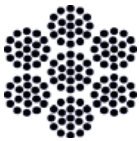

7 x 19 Construction

Most flexible and widely used constructions well suited for a multitude of applications.

PVC and Nylon Coated Cables

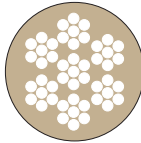

7 x 7 Construction

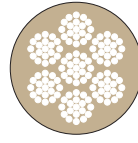

7 x 19 Construction

- Supplied with UV inhibitors
- When using wire rope clips or compression sleeves with plastic coated cables, match fitting size to uncoated cable diameter
- Strip coating off cable where fittings will be positioned for full holding power

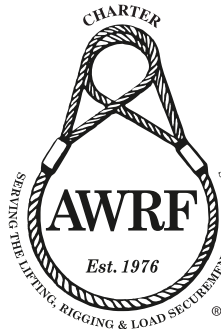

Warning:

Working Load Limits will depend on the actual usage (NBS/Safety Margin)



SMALL DIAMETER CABLES

Manufactured in accordance to U.S. Mil. Spec. DTL-8342M, endurance test omitted

Galvanized

Preformed Galvanized Cables are recommended whenever flexibility, high strength and fatigue resistance are required.

Diameter (inches)	Weight (lbs/1000')	Nominal B/S (lbs)	Vanguard Code
7 x 7 Construction			
1/16	7.5	480	2701 0004
3/32	16.0	920	2701 0006
1/8	28.5	1,700	2701 0008
3/16	62.0	3,700	2701 0012
7 x 19 Construction			
3/32	16.0	1,000	2703 0006
1/8	29.0	2,000	2703 0008
5/32	45.0	2,800	2703 0010
3/16	65.0	4,200	2703 0012
1/4	110.0	7,000	2703 0016
5/16	173.0	9,800	2703 0020
3/8	243.0	14,400	2703 0024

Plastic Vinyl Coated (PVC)

Galvanized Steel Cable

Diameter (inches)	Colour	Weight (lbs/1000')	Nominal B/S (lbs)	Vanguard Code
7 x 7 Construction				
1/16 - 3/32	Clear	9.5	480	2710 0006
3/32 - 1/8	Clear	27.0	920	2710 0008
3/32 - 3/16	Clear	27.0	920	2710 0012
	Yellow			2715 0012
	Orange			2717 0012
1/8 - 3/16	Clear	37.0	1,700	2710 1012
7 x 19 Construction				
1/8 - 3/16	Clear	39.0	2,000	2730 0012
	Black			2725 0012
1/8 - 1/4	Clear	51.0	2,000	2711 0016
	Black			2725 0016
3/16 - 1/4	Clear	78.0	4,200	2730 0016
	Black Nylon			2730 1016
1/4 - 5/16	Orange	125.0	7,000	2725 2020
	Red			2735 0020

- * All colors, coatings and sizes of coated cables may not be a standard stock item at all distribution centres.
- * Additional colors, coatings and sizes are available as a special order minimum quantity may apply.

Stainless Steel

Stainless Steel Cables offer an excellent combination of corrosion and fatigue resistance and high strength.

Type 302/304 - Standard Grade

Type 316 - Superior corrosion resistance

Diameter (inches)	Weight (lbs/1000')	Nominal B/S (lbs)	Vanguard Code
1 x 19 Construction			
1/16	8.5	500	2802 0004
3/32	20.0	1,200	2802 0006
1/8	35.0	2,100	2802 0008
5/32	55.0	3,300	2802 0010
3/16	77.0	4,700	2802 0012
7/32	102.0	6,300	2802 0014
1/4	135.0	8,200	2802 0016
9/32	170.0	10,300	2802 0018
5/16	210.0	12,500	2802 0020
3/8	317.0	17,100	2802 0024
7 x 7 Construction			
3/64	4.2	240	2801 0003
1/16	7.5	480	2801 0004
3/32	16.0	920	2801 0006
1/8	28.5	1,700	2801 0008
7 x 19 Construction			
3/32	16.0	1,050	2803 0006
1/8	29.0	1,760	2803 0008
5/32	45.0	2,400	2803 0010
3/16	65.0	3,700	2803 0012
1/4	110.0	6,400	2803 0016
5/16	173.0	9,000	2803 0020
3/8	243.0	12,000	2803 0024

Plastic Vinyl Coated (PVC)

Stainless Steel Cable (Type 304)

Diameter (inches)	Colour	Weight (lbs/1000')	Nominal B/S (lbs)	Vanguard Code
7 x 7 Construction				
1/16 - 3/32	White	13.0	480	2811 0006
3/32 - 1/8	White	25.0	920	2811 0008
1/8 - 1/4	White	50.0	1,760	2811 0016
3/16 - 5/16	White	91.0	3,700	2811 0020

Warning:

Working Load Limits will depend on the actual usage (NBS/Safety Margin)

WIRE ROPES & CABLES

7 x 7 x 7 CABLE LAID IWRC GALVANIZED

Cable-laid rope consists of several constituent wire ropes that are helically laid or wound over a core into a single cable.

For example if you used 7 cables of 1/16" 7 x 7 and closed them into a wire rope you would have a 3/16" diameter 7 x 7 x 7 containing 343 individual wires. The end product is a highly flexible, strong wire rope that can be spliced easily into slings or other assemblies.



When used for sling production, cable laid wire rope offers greater flexibility than slings made with 6 x 19 Class wire rope, however cable laid slings have a lower nominal breaking strength.

- An extremely flexible wire rope
- Corrosion resistant

Diameter (inches)	Approx. Weight (lbs/ft)	Nominal B/S (lbs)	Vanguard Code
5/16	0.14	10,700	3601 0020
3/8	0.21	11,400	3601 0024
7/16	0.30	18,000	3601 0028

* May not be a standard stock item at all distribution centres.

** Additional sized and configurations available upon request, minimum order quantity may apply

HOSE RESTRAINTS



Hose restraints are simple and economical means of implementing work place safety measures. They are highly resistant to rust and corrosion and do not require any tools to install.

Hose restraints are used to restrain the movement of the pressurized hose should it become uncoupled, thereby allowing operators to get away and perform a safe, orderly system shut-down.

- Corrosion resistant
- No tools are required for installation

Hose Diameter (inches)	Overall Assembly Length (inches)	Diameter of Cable Used (inches)	Weight (lbs)	Vanguard Code
1/2 - 1-1/4	15	1/8	0.15	3317 0815
1/2 - 1-1/4	22	1/8	0.23	3317 0822
1-1/2 - 3	24	1/4	0.90	3317 1624
1-1/2 - 3	36	1/4	1.22	3317 1636
3-1/2 - 6	48	3/8	3.00	3317 2448

* May not be a standard stock item at all distribution centres.

** Additional sized and configurations available upon request, minimum order quantity may apply

Warning:

**NEVER EXCEED WORKING LOAD LIMIT OR 20% OF THE PRODUCTS BREAKING STRENGTH!
Failure to follow instructions can result in serious property damage, injury or death!**

- Acceptable strength is not less than 2.5% below the nominal breaking strength lists above



1 x 7 GALVANIZED GUY STRAND/MESSENGER CABLE

Commonly used for guying purposes where flexibility is not important. Widely used in the power and telecommunication industry.

- Very stiff and cannot be spliced
- Corrosion resistant
- Manufactured in accordance with ASTM A475, Class A and/or CAN/CSA-G12-92



Applications:

- underground cable
- long distance overhead cable
- tower erecting and support

Diameter (inches)	Approx. Weight (lbs/ft)	Min. Breaking Strength (lbs)	Vanguard Code	Min. Breaking Strength (lbs)	Vanguard Code	Min. Breaking Strength (lbs)	Vanguard Code
ASTM A475 Class A							
Grade		Siemens - Martin		High Strength		Extra-High Strength	
3/16	0.08	1,900		2,850		3,990	3501 5012
1/4	0.13	3,150		4,750		6,650	3501 5016
5/16	0.22	5,350		8,000		11,200	3501 5020
3/8	0.27	6,950		10,800		15,400	3501 5024
7/16	0.39	9,350		14,500		20,800	3501 5028
1/2	0.52	12,100		18,800		26,900	3501 5032
9/16	0.67	15,700		24,500		35,000	3501 5036
5/8	0.81	19,100		29,600		42,400	3501 5040
CAN/CSA-G12/92							
Grade		Grade 110		Grade 160		Grade 180	
3/16	0.08	2,400	3501 1012	3,500	3501 3012	4,000	3501 2012
1/4	0.13	3,900	3501 1016	5,700	3501 3016	6,400	3501 2016
5/16	0.22	6,800	3501 1020	9,900	3501 3020	11,100	3501 2020
3/8	0.27	8,200	3501 1024	12,000	3501 3024	13,500	3501 2024
7/16	0.39	11,900	3501 1028	17,300	3501 3028	19,500	3501 2028
1/2	0.51	15,600	3501 1032	22,700	3501 3032	25,500	3501 2032
5/8	0.81	24,600	3501 1040	35,800	3501 3040	40,200	3501 2040

* May not be a standard stock item at all distribution centres.

** Additional grades, diameters and constructions available upon request, minimum order quantity may apply



90/10 Zinc-Aluminum Coated Wire Strand

Having recognized the advantages of 95% Zinc + 5% Aluminum coatings applied to carbon steel wires and taking it one step further, increasing the Aluminum content has proven to further enhance the corrosion resistance and ductility of Vanguard Guys and Messenger Strand over conventional galvanizing.

This makes the use of V-Alloy strand the ideal choice for use in corrosive environments.



**NEVER EXCEED WORKING LOAD LIMIT OR 20% OF THE PRODUCTS BREAKING STRENGTH!
Failure to follow instructions can result in serious property damage, injury or death!**

- Acceptable strength is not less than 2.5% below the nominal breaking strength lists above

WIRE ROPES & CABLES

6 x 19 CLASSIFICATION

This classification covers ropes with 6 strands having 8 to 26 wires per strand, no more than 12 of which are outer wires

- Provide excellent service with sheaves and drums of moderate size
- Flexible wire with good balance of abrasion, wear, crush and fatigue resistance
- Very versatile general purpose wire rope

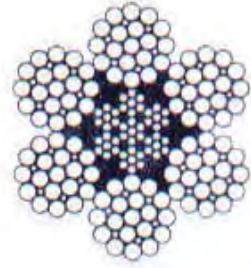

Standards:

RR-W-410G

Applications:

Winch lines, railings, suspension cables, boom pendants, boom hoists anchor lines, logging lines, tube lines and widely used in the fabrication of wire rope slings. Also used as a hoisting rope on many older design overhead cranes.

Diameter (inches)	Steel Core (IWRC)			Fibre Core (FC)			Vanguard Code
	Weight (lbs/ft)	EIPS Nominal B/S (tons)		Weight (lbs/ft)	IPS Nominal B/S (tons)		
		Bare	Galvanized		Bare	Galvanized	
1/4	0.12	3.40	3.06	0.11	2.74	2.47 0016
5/16	0.18	5.27	4.74	0.16	4.26	3.83 0020
3/8	0.26	7.55	6.80	0.24	6.10	5.49 0024
7/16	0.35	10.20	9.18	0.32	8.27	7.44 0028
1/2	0.46	13.30	12.00	0.42	10.70	9.63 0032
9/16	0.59	16.80	15.10	0.53	13.50	12.15 0036
5/8	0.72	20.60	18.50	0.66	16.70	15.00 0040
3/4	1.04	29.40	26.50	0.95	23.80	21.40 0048
7/8	1.42	39.80	35.80	1.29	32.20	29.00 0056
1	1.85	51.70	46.50	1.68	41.80	37.60 0100
1-1/8	2.34	65.00	58.50	2.13	52.60	47.30 0108
1-1/4	2.89	79.90	71.90	2.63	64.60	58.10 0116
1-1/2	4.16	114.00	103.00	3.78	92.00	82.80 0132

* Additional diameters and constructions available upon request, minimum order quantity may apply

Vanguard Prefix:	
2563	6 x 19 IWRC
2662	6 x 19 IWRC Galvanized
2566	6 x 19 IWRC Seale
2576	6 x 25 IWRC
2676	6 x 25 IWRC Galvanized
2512	6 x 19 Fiber Core
2612	6 x 19 Fiber Core Galvanized
2621	6 x 24 Fiber Core Galvanized
2526	6 x 25 Fiber Core
2626	6 x 25 Fiber Core Galvanized

* Not all constructions or diameters are a standard stock item at all distribution centres.

Warning:

NEVER EXCEED WORKING LOAD LIMIT OR 20% OF THE PRODUCTS BREAKING STRENGTH!
Failure to follow instructions can result in serious property damage, injury or death!

- Acceptable strength is not less than 2.5% below the nominal breaking strength lists above
- 6 x 19 wire rope are NOT rotation/spin resistant

6 x 36 CLASSIFICATION

This classification of wire rope has a third layer of wires which make them more flexible although less abrasion-resistant than ropes of the 6 x 19 class. Comparatively small diameter wires which offer superior bending ability. As the number of wires in each strand increases, flexibility increases.



- This classification covers ropes with 6 strands having 27 to 49 wires per strand.
- Excellent flexibility wire rope with good fatigue resistance
- Reasonable resistance to crushing, but not as crush resistant as 6 x 19 class
- Well adapted to high speed multiple reeving applications
- Very versatile general purpose wire rope

Fiber core (FC) construction is much more elastic under load (stretch), which offers greater energy absorption capability, however it is much less crush resistant than steel core (IWRC).

Standards:
RR-W-410G

Applications:
Overhead crane and mobile crane hoist ropes; winch lines; large diameter towing lines, main and auxiliary hoist lines on steel mill cranes and also well suited for larger diameter wire rope sling fabrication.

Diameter (inches)	Steel Core (IWRC)			Fibre Core (FC)			Vanguard Code Prefix +
	Weight (lbs/ft)	EIPS Nominal B/S (tons)		Weight (lbs/ft)	IPS Nominal B/S (tons)		
		Bare	Galvanized		Bare	Galvanized	
1/4	0.12	3.40	3.06	0.11	2.74	2.47 0016
5/16	0.18	5.27	4.74	0.16	4.26	3.83 0020
3/8	0.26	7.55	6.80	0.24	6.10	5.49 0024
7/16	0.35	10.20	9.18	0.32	8.27	7.44 0028
1/2	0.46	13.30	12.00	0.42	10.70	9.63 0032
9/16	0.59	16.80	15.10	0.53	13.50	12.15 0036
5/8	0.72	20.60	18.50	0.66	16.70	15.00 0040
3/4	1.04	29.40	26.50	0.95	23.80	21.40 0048
7/8	1.42	39.80	35.80	1.29	32.20	29.00 0056
1	1.85	51.70	46.50	1.68	41.80	37.60 0100
1-1/8	2.34	65.00	58.50	2.13	52.60	47.30 0108
1-1/4	2.89	79.90	71.90	2.63	64.60	58.10 0116

* Additional diameters and constructions available upon request, minimum order quantity may apply

Vanguard Prefix:	
2591	6 x 36 IWRC Warrington Seale
2690	6 x 36 IWRC Warrington Seale Galvanized
2540	6 x 36 Fiber Core Warrington Seale

* Not all constructions or diameters are a standard stock item at all distribution centres.



**NEVER EXCEED WORKING LOAD LIMIT OR 20% OF THE PRODUCTS BREAKING STRENGTH!
Failure to follow instructions can result in serious property damage, injury or death!**

- Acceptable strength is not less than 2.5% below the nominal breaking strength lists above
- 6 x 36 wire rope are NOT rotation/spin resistant

WIRE ROPES & CABLES

19 x 7 CLASSIFICATION IWRC

The non-rotating characterizing is achieved by two layers of strand, one having right lay, the other left lay.

- Rotation resistant but NOT non-rotating
- Requires frequent inspection as damage to inner strands and wires cannot be easily detected
- Not recommended for multiple part lifting

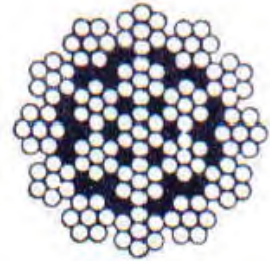

Standards:

RR-W-410G

Applications:

Hoisting ropes on derricks, boom cranes, shaft sinking hoists and freely suspended mine hoists, deck cranes, piling rigs main and auxiliary hoist lines on mobile and truck cranes.

Diameter (inches)	Weight (lbs/ft)	Nominal B/S (tons)		Vanguard Code (Prefix +)
		EIPS	IPS	
1/4	0.11	2.70	2.51 0016
5/16	0.18	4.30	3.90 0020
3/8	0.25	6.10	5.59 0024
7/16	0.35	8.33	7.58 0028
1/2	0.45	10.80	9.84 0032
9/16	0.58	13.60	12.40 0036
5/8	0.71	16.80	15.30 0040
3/4	1.02	24.00	21.80 0048
7/8	1.39	32.50	29.50 0056
1	1.82	42.20	38.30 0100
1-1/8	2.30	53.10	48.20 0108

* Additional diameters and constructions available upon request, minimum order quantity may apply

Vanguard Prefix:

2596	19 x 7 IWRC IPS
2597	19 x 7 IWRC EIPS

* Not all constructions or diameters are a standard stock item at all distribution centres.

Warning:

**NEVER EXCEED WORKING LOAD LIMIT OR 20% OF THE PRODUCTS BREAKING STRENGTH!
Failure to follow instructions can result in serious property damage, injury or death!**

- Acceptable strength is not less than 2.5% below the nominal breaking strength lists above

6 x 26 SWAGED AND SUPER SWAGED IWRC

Swaged ropes are produced by reducing the diameter of a regular round rope by compacting it. Swaging provides additional stability to rope shape and creates surface-to-surface contact between element wires. By packing more steel into a smaller diameter.

The swaging process produces a superior strength to diameter ratio and breaking that is higher than traditional rope while also offering greater resistance to drum crushing, scrubbing and similar wear.

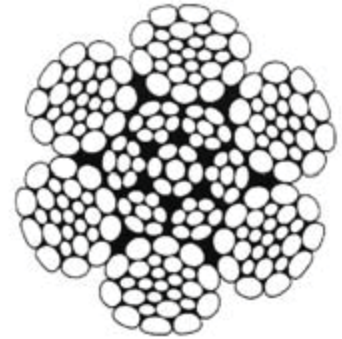

Standards:
RR-W-410G

Applications:
Boom hoists, logging operations but can be adapted for other uses; IWRC shown, fiber core available.

Diameter (inches)	Swaged Construction			Super Swaged Construction		
	Approx. Weight (lbs/ft)	Nominal B/S (tons)	Vanguard Code	Approx. Weight (lbs/ft)	Nominal B/S (tons)	Vanguard Code
3/8	0.34	8.90	2599 0024			
1/2	0.55	15.90	2599 0032	0.61	17.40	2599 0033
9/16	0.71	19.30	2599 0036	0.78	21.90	2599 0041
5/8	0.87	24.20	2599 0040	0.97	27.00	2599 0045
3/4	1.25	34.90	2599 0048	1.38	38.50	2599 0049
7/8	1.70	34.40	2599 0056	1.87	52.00	2599 0058
1	2.22	62.00	2599 0100	2.44	66.50	2599 01002
1-1/8	2.81	73.50	2599 0108	3.09		
1-1/4	3.47	90.00	2599 0116	3.82		

* May not be a standard stock item at all distribution centres.
** Additional grades, diameters and constructions available upon request, minimum order quantity may apply

Warning:

**NEVER EXCEED WORKING LOAD LIMIT OR 20% OF THE PRODUCTS BREAKING STRENGTH!
Failure to follow instructions can result in serious property damage, injury or death!**

- Acceptable strength is not less than 2.5% below the nominal breaking strength lists above
- 6 x 26 swaged wire ropes are NOT rotation/spin resistant



TOWER KING 12 1960 RLL

Nominal Diameters: 12.0 to 36.0mm
 Filling Factor: 0.721
 Total Number of wires: 245

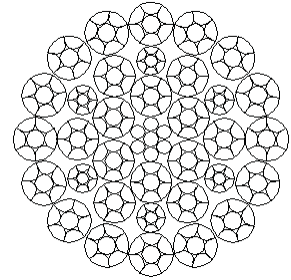

- 34 Strand compacted rope
- High breaking Strength
- Rotation Resistant
- More efficient due to high flexibility
- Super bend fatigue extending service life
- Langs Lay offers a larger wire surface rendering a higher resistance to abrasion
- Optimal winding performance in multi-layer use

Applications:

Engineered to meet the demanding requirements of tower cranes, mobile cranes, deck cranes and dockside cranes.

Diameter (mm)	Approx. Weight (lbs/ft)	Minimum Breaking Load				Vanguard Code
		1960 N/mm ²	Metric Tons (2,240lbs)	2160 N/mm ²	Metric Tons (2,240lbs)	
14	0.65	178	18.2	191	19.4	2585 3014
15	0.74	205	20.9	219	22.3	2585 3015
16	0.85	233	23.7	249	25.4	2585 3016
18	1.07	295	30.1	315	32.1	2585 3018
19	1.13	328	33.5	351	35.8	2585 3019
24	1.80	524	53.4	560	57.1	2585 3024

* May not be a standard stock item at all distribution centres.

** Additional grades, diameters and constructions available upon request, minimum order quantity may apply

Warning:

**NEVER EXCEED WORKING LOAD LIMIT OR 20% OF THE PRODUCTS BREAKING STRENGTH!
 Failure to follow instructions can result in serious property damage, injury or death!**

- Acceptable strength is not less than 2.5% below the nominal breaking strength lists above

VPC 10P 1960 RLL

Nominal Diameters: 12.0 to 40.0mm
 Filling Factor: 0.704
 Total Number of wires: 389

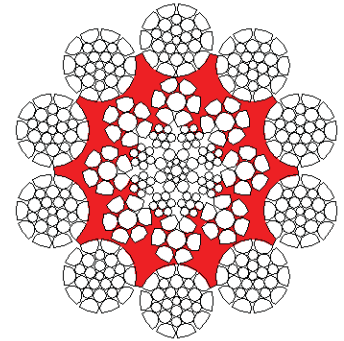

- 10 Strand compacted rope
- Regular or Langs Lay
- High breaking Strength
- Increased service life
- Plastic filler between outer strands and inner core

Applications:

Engineered to meet the demanding requirements of tower cranes, mobile cranes, deck cranes and dockside cranes.

Diameter (mm)	Approx. Weight (lbs/ft)	Minimum Breaking Load				Vanguard Code
		1770 N/mm ²	Metric Tons (2,240lbs)	1960 N/mm ²	Metric Tons (2,240lbs)	
14	0.62	177	18.0	191	19.4	2586 0014
25	1.97	564	57.5	608	62.0	2586 0025
28	2.46	708	72.2	762	77.7	2586 0028

* May not be a standard stock item at all distribution centres.

** Additional grades, diameters and constructions available upon request, minimum order quantity may apply

Warning:

**NEVER EXCEED WORKING LOAD LIMIT OR 20% OF THE PRODUCTS BREAKING STRENGTH!
 Failure to follow instructions can result in serious property damage, injury or death!**

- Acceptable strength is not less than 2.5% below the nominal breaking strength lists above

WIRE ROPES & CABLES

SPECIALTY WIRE LINE CABLES

The term wire line usually refers to a cabling technology used by operators of oil and gas wells to lower equipment or measurement devices into the well for the purposes of well intervention and reservoir evaluation.

3 x 7 SWAGED WIRE ROPE IWRC

- A wire rope 3/16" or 1/4" (4.8 mm or 6.4 mm) in diameter; used to handle the inner tube of a wire-line core barrel.
- The 3-strand compacted design provides resistance to rotation while also providing a high strength/weight ratio.
- Compacting the rope also results in an exceptionally dense cross-section. The increased surface area, improves rope contact with the sheaves and drums. Providing greater resistance to surface wear and abrasion, reducing wear on the sheaves.
- These 3-strand ropes are ideal for diamond drilling operations.

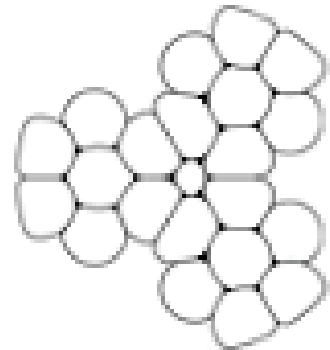

Diameter (inches)	Wire Rope Lay	Weight (lbs/ft)	Nominal B/S (lbs)	Vanguard Code
Steel Core				
3/16	LHRL	0.08	4,650	2599 0012
3/16	RHRL	0.08	4,650	2599 00121
1/4	LHRL	0.16	8,600	2599 0016
Super Swaged				
3/16	LHRL	0.08	4,950	2599 1012

* May not be a standard stock item at all distribution centres.

1 x 19 ARMORED CABLE

- Used for retrieving core samples
- Galvanized cable with armouring
- Armouring prevents fraying of cable in rough terrain

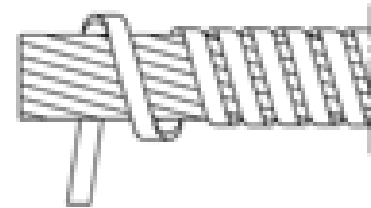

Diameter (inches)		Weight (lbs/ft)	Nominal B/S (lbs)	Vanguard Code
Outer	Inner			
11/16	1/8	0.08	4,000	2599 1111

* May not be a standard stock item at all distribution centres.

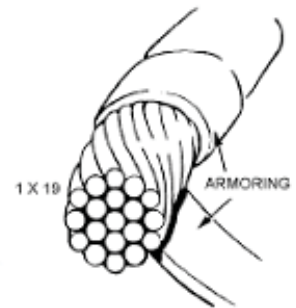

Warning:

**NEVER EXCEED WORKING LOAD LIMIT OR 20% OF THE PRODUCTS BREAKING STRENGTH!
Failure to follow instructions can result in serious property damage, injury or death!**

- Acceptable strength is not less than 2.5% below the nominal breaking strength lists above

WIRE ROPE HARDWARE



VANGUARD STEEL LTD.

WIRE ROPE CLIP WARNINGS AND INFORMATION

It is very important to read and understand all information shown before using a wire rope clips



'Golden U-Bolt' Drop Forged
Heavy Duty Applications



Malleable
Light Duty Applications





T-316 Stainless Steel
Light Duty Applications



WARNING

FAILURE TO OBSERVE THESE WARNINGS MAY RESULT IN SERIOUS INJURY OR DEATH!

- **ALWAYS** inspect wire rope clips before use. Check for wear, damage, bending or deformation. Also check the working condition of the saddle, threads on u-bolt and nuts.
- **ALWAYS** make sure to perform regular inspection of the wire rope end termination, clips and thimbles looking for signs of wear, abuse and general adequacy
- **ALWAYS** destroy and dispose of wire rope clips that are beyond safe use
- **NEVER** substitute competitors saddle or nuts on Vanguard wire rope clips
- **NEVER** use with plastic coated wire rope
- **NEVER** stagger clips
- **NEVER** 'saddle a dead horse' - the U goes on the dead end of the rope where crushing will not affect the breaking strength of the hoist line
- **NEVER** join ropes without the use of a thimble
- **NEVER** shock load
- **ALWAYS** match the same size clip with the same sized wire rope
- **ALWAYS** make sure to prepare wire rope end and termination only as instructed, for greater detail please refer to installation steps chart shown below
- **ALWAYS** make sure that you have used the recommended number of clips and the correct amount of rope turn back from the thimble before testing the assembly. If a pulley/sheave is used instead of a thimble add one additional clip
- **ALWAYS** use at least three clips when making any prepared loop or thimble-eye termination for wire rope, especially for hoisting.
- **ALWAYS** make sure that the clips are evenly spaced apart
- **ALWAYS** make sure to test assemblies before each use. The load should be of equal or greater weight than the loads expected to be hoisted, making sure to check and retighten (if necessary the nuts to their recommended torque value.

Installation			
<p>Step 1: APPLY 1st clip one base width from dead end of the rope - U-bolt over dead end - live end rests in clip saddle. Tighten nuts evenly to recommended torque.</p> 	<p>Step 2: APPLY 2nd clip as close to loop as possible - U-bolt over dead end - turn nuts firmly but do not tighten!</p> 	<p>Step 3: ALL OTHER CLIPS - Space evenly between first two.</p> 	<p>Step 4: APPLY TENSION and tighten all nuts to recommended torque. RE-CHECK nut torque after rope has been in operation</p>

WIRE ROPE HARDWARE

MALLEABLE WIRE ROPE CLIPS

- To be used for light duty, non-critical applications only
- Typical uses include guard lines and fencing
- Electro-galvanized finish
- Rope diameter stamped on saddle
- Federal Specification FF-C-450D, Type 1, Class 2
- Torque tested threads
- The tightening torque values shown are based upon the threads being clean, dry and free of lubrication

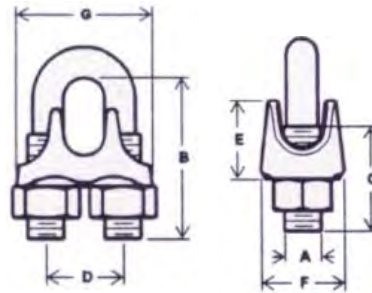

Rope Diameter	Weight (lbs/100)	Dimensions (inches)							Nut Torque (ft/lbs)	Min. No. Clips	Turn Back Length (inches)	Vanguard Code
		A	B	C	D	E	F	G				
1/16**	4.30	0.15	0.65	0.34	0.46	0.36	0.43	0.66	2.0	3	3.00	2901 0004
1/8**	4.30	0.18	0.72	0.56	0.43	0.43	0.55	0.85	3.0	3	4.75	2901 0008
3/16	6.80	0.23	0.92	0.63	0.54	0.52	0.61	1.05	4.5	3	5.50	2901 0012
1/4	14.50	0.30	1.13	0.83	0.67	0.60	0.76	1.23	15.0	3	7.00	2901 0016
5/16	15.00	0.30	1.23	0.86	0.69	0.64	0.82	1.34	15.0	3	7.75	2901 0020
3/8	21.50	0.36	1.50	1.06	0.88	0.90	0.92	1.58	30.0	3	9.50	2901 0024
7/16	24.00	0.36	1.54	1.07	0.94	0.87	0.93	1.64	40.0	3	10.25	2901 0028
1/2	37.00	0.42	1.96	1.28	1.04	0.94	1.07	1.91	45.0	4	15.25	2901 0032
5/8	59.00	0.48	2.14	1.39	1.30	1.10	1.16	2.23	75.0	4	16.00	2901 0040
3/4	84.00	0.54	2.54	1.46	1.33	1.35	1.30	2.40	75.0	5	22.25	2901 0048
7/8	128.00	0.61	2.90	1.77	1.55	1.53	1.46	2.77	130.0	5	23.50	2901 0056
1	150.00	0.61	3.23	2.15	1.81	1.73	1.74	3.02	130.0	6	31.00	2901 0100
1-1/8	243.00	0.72	4.44	2.70	1.84	1.97	1.77	3.24	200.0	7	39.00	2901 0108

** Note: 1/16" and 1/8" are not covered by Federal Specification FF-C-450D

STAINLESS WIRE ROPE CLIPS

- To be used for light duty, non-critical applications only
- Made from Type 316 stainless steel
- Electro-polished finish
- Rope diameter stamped on saddle

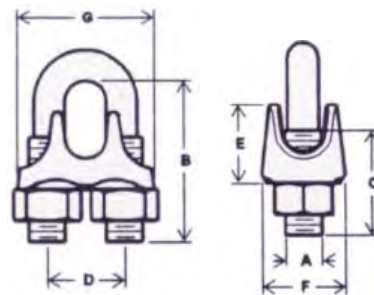

Rope Diameter	Weight (lbs/100)	Dimensions (inches)							Vanguard Code
		A	B	C	D	E	F	G	
1/8	4	0.19	0.81	0.55	0.40	0.40	0.51	0.82	2915 0008
5/32	5	0.17	0.93	0.63	0.52	0.46	0.55	0.92	2915 0010
3/16	6	0.23	0.97	0.60	0.56	0.50	0.55	1.00	2915 0012
1/4	13	0.30	1.24	0.85	0.71	0.59	0.71	1.24	2915 0016
5/16	15	0.30	1.40	0.90	0.80	0.60	0.77	1.38	2915 0020
3/8	28	0.37	1.81	1.15	0.90	0.88	0.82	1.58	2915 0024
1/2	42	0.44	2.14	1.34	1.20	0.90	1.00	1.93	2915 0032

Warning:

Failure to follow these instructions can result in serious property damage, injury or death!

- NEVER use malleable or stainless steel clips for overhead lifting

'GOLDEN U-BOLT'® FORGED WIRE ROPE CLIPS

- Meet Federal Spec. FF-C-450, Type 1, Class 1 and ASME B30.26 standard
- Forged saddle, hot dipped galvanized, permanently embossed with VGD®, size and forged
- Gold Chromated U-Bolts and Nuts identify 'Vanguard' product
- Torque tested threads
- The tightening torque values shown are based upon the threads being clean, dry and free of lubrication.

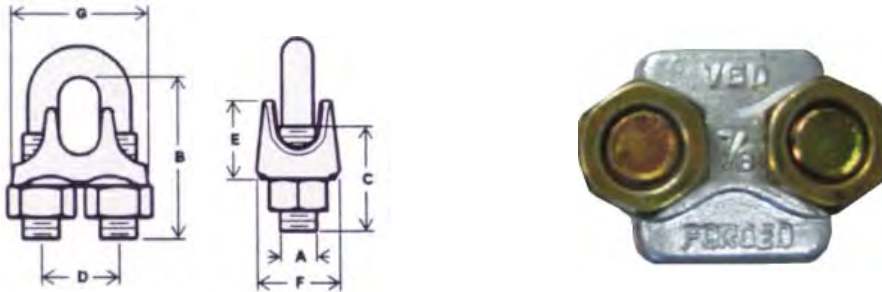

Rope Diameter	Min. No. of Clips	Rope turn-back	Torque (ft lbs)	Weight (lbs/100)	Dimensions (inches)							Vanguard Code
					A	B	C	D	E	F	G	
1/8	2	3-1/4	4.5	6	0.20	0.75	0.54	0.41	0.48	0.80	0.90	2907 0008
3/16	2	3-3/4	7.5	10	0.24	0.98	0.65	0.56	0.55	0.95	1.16	2907 0012
1/4	2	4-3/4	15.0	19	0.30	1.06	0.67	0.78	0.67	1.18	1.54	2907 0016
5/16	2	5-1/2	30.0	29	0.37	1.35	0.80	0.84	0.77	1.33	1.65	2907 0020
3/8	2	6-1/2	45.0	44	0.42	1.50	0.81	0.96	0.98	1.55	1.92	2907 0024
1/2	3	11-1/2	65.0	73	0.48	1.83	1.10	1.12	1.19	1.91	2.29	2907 0032
5/8	3	12	95.0	102	0.54	2.40	1.22	1.38	1.33	2.05	2.50	2907 0040
3/4	4	18	130.0	142	0.61	2.84	1.51	1.51	1.40	2.25	2.82	2907 0048
7/8	4	19	225.0	212	0.73	3.10	1.79	1.73	1.60	2.41	3.16	2907 0056
1	5	26	225.0	255	0.73	3.58	1.80	1.85	1.77	2.64	3.44	2907 0100
1-1/8	6	34	225.0	280	0.73	3.90	2.09	1.95	1.95	2.74	3.52	2907 0108
1-1/4	7	37	360.0	437	0.86	4.26	2.13	2.37	2.31	3.14	4.11	2907 0116
1-1/2	7	48	360.0	531	0.86	4.78	2.42	2.53	2.51	3.35	4.41	2907 0132
1-3/4	7	53	590.0	980	1.09	5.64	2.85	3.10	2.94	3.82	5.28	2907 0148
2	8	71	750.0	1,375	1.20	6.75	3.11	3.31	3.31	4.41	5.86	2907 0200

* Additional sizes available upon request, minimum order quantity may apply.

Warning:

Failure to follow these instructions can result in serious property damage, injury or death!

- **NEVER** stagger clips
- **NEVER** mount U-Bolts over live end of rope
- **NEVER** join ropes without the use of a thimble
- For more information please see the wire rope clip warning and information section found in the hardware section of this catalogue

'GOLDEN U-BOLT'® FORGED WIRE ROPE CLIPS



Efficiency rating:

The efficiency rating for wire rope end terminations are based upon the catalogue strength of standard EIPS wire rope. The efficiency rating of properly prepared loop or thimble - eye termination for clips between the sizes of 1/8 to 7/8" is 80% and for 1 to 2" it is 90%.

Note:

- If a greater number of clips are used than shown in the table, the amount of rope turn back should be increased proportionately.
- If a pulley/sheave is used instead of a thimble add one additional clip.
- The tightening torque values shown are based upon the threads being clean, dry and free of lubrication.

The number of clips shown on this chart is based upon using RRL or RLL 6 x 19 and/or 6 x 36 classes of steel core (IWRC) and fiber core (FC) wire ropes, IPS, EIPS and EEIPS.

For Seale construction or other large outer wire type construction in the 6 x 19 classification one additional clip is required for sizes 1" or larger.

The information on this chart also covers 8 x 19 classes, IPS, EIPS and EEIPS for sizes up to and including 1-1/2" and rotation resistant 19 x 7 class, IPS, EIPS and EEIPS for sizes up to and including 1-3/4".

For elevator, personal hoist and scaffold applications refer to ASME A17.1 and ANSI A10.4. These standards do not recommend U-bolts wire rope terminations.

SHACKLE WARNINGS AND INFORMATION

It is very important to read and understand all information shown before using a shackle



Screw Pin Anchor Shackles



Bolt Type Anchor Shackles



Screw Pin Chain Shackles

WARNING

FAILURE TO OBSERVE THESE WARNINGS MAY RESULT IN SERIOUS INJURY OR DEATH!

- **ALWAYS** inspect shackles before use. Check for wear, damage, bent or elongation of the body or pin, spreading of the shackle legs also check to see if there is any damage to the threads.
- **NEVER** replace shackle pins with a competitors pin
- **NEVER** replace a shackle pin with a bolt pin, the load will bend the pin
- **NEVER** exceed 120° included angle. Use Bolt Type and/or Screw Pin Shackles ONLY.
- **NEVER** re-use shackles or pins which are visibly deformed
- **NEVER** use shackles which are worn in the crown or pin by more than 10% of the original diameter
- **NEVER** use screw pin shackles if the pin can roll under the load – bolt type shackles with cotter pin are recommended for these applications
- **NEVER** proof test shackles beyond 2 times the working load limit (WLL)
- **NEVER** modify, repair or reshape a shackle by welding, heating or bending as this will affect the working load limit (WLL)
- **NEVER** allow a shackle to be pulled at an angle; this will cause the legs to open. The pin should be packed with washers to centre the shackle
- **NEVER** shock load
- **ALWAYS** make sure that the shackle being used is large enough to avoid pinching or bunching when used with synthetic slings
- **ALWAYS** make sure that the diameter of the shackle is greater than the wire rope diameter if there is no thimble in the eye
- **ALWAYS** mouse screw pin shackles when used in long term or high vibration applications
- **ALWAYS** make sure that the shackle properly supports the load.

Working Load Limits (WLL) are based on shackles in new condition and are subject to downward adjustment in case of side loading:

Side Load Capacity Reduction Chart	
Angle of side load	Capacity
0° from vertical in-line	100% of the WLL
45° from vertical in-line	70% of the WLL
90° from vertical in-line	50% of the WLL

* For screw pin and bolt type shackles only – NEVER side load round pin/chain shackles

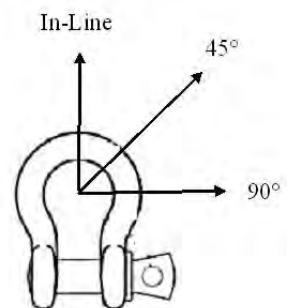



WARNING

SHACKLE WARNINGS AND INFORMATION

It is very important to read and understand all information shown before using a shackle

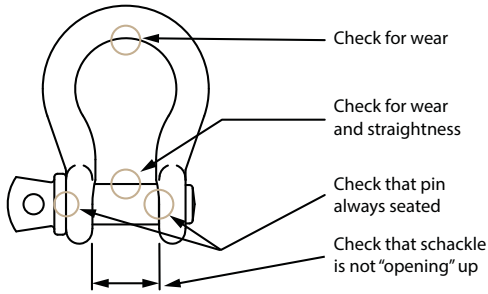

Shackle inspection

Check for wear, damage, bent or elongation of the body or pin, spreading of the shackle legs also check to see if there is any damage to the threads.

Eccentric shackle loads

To prevent an angular lift with a shackle, pack the pin. This will centre the load preventing the legs from spreading and the shackle from failing

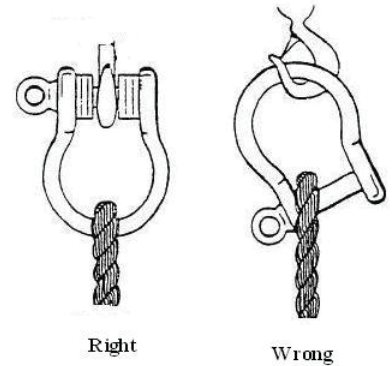
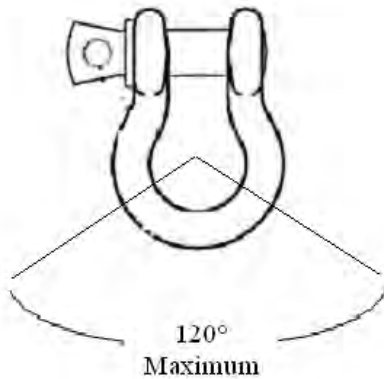

Symmetrical loading

Shackles symmetrically loaded with two leg slings having a maximum included angle of 120° can be utilized to full Working Load Limit (WLL). Only bolt type with cotter pin and screw pin shackles should be used for this application.

Rolling of the pin

If the load shifts the sling can unscrew the shackle pin. For long term applications or where the load can cause the pin to rotate, bolt type shackles with cotter pin should be used.

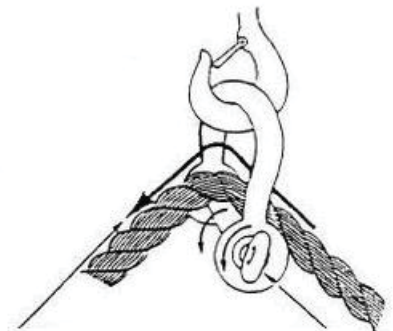

Mousing of a screw pin shackle

Mousing is a secondary securement method used to secure screw pin from rotation or loosening. Annealed iron wire is looped through the hole in collar of pin and around adjacent leg of shackle body with wire ends securely twisted together.

Multiple wraps are required for securement where the load may slide on the shackle pin.

'GOLDEN PIN'® SCREW PIN ANCHOR SHACKLES

- Meet the performance requirements of U.S. Fed. Spec. RR-C-271D, Type 4A, Grade A, Class 2
- Heat treated carbon steel bows, quenched and tempered with Alloy pins
- Hot dipped galvanized
- Metallic coating of shackle pins allows for closer thread tolerances than possible for shackles with an extra layer of paint
- Design factor 6:1



To assure total traceability and to exceed the requirements of ASME B30.26

'Golden Pin' shackles bodies are embossed with:

- Vanguard
- WLL (working load limit)
- Size
- Trace Code

'Golden Pin' shackles pins are stamped with:

- Vanguard I.D. (VGD®)
- Alloy Pin I.D.WLL (HS)
- Yellow chromated for instant recognition
- Trace Code

Size	Pin Diameter	Dimensions (inches)				WLL (tons)	Weight (lbs)	Vanguard Code
		A	B	C	F			
3/16	1/4	0.93	0.39	0.59	0.64	1/3	0.06	2902 0012
1/4	5/16	1.14	0.49	0.70	0.75	1/2	0.12	2902 0016
5/16	3/8	1.23	0.53	0.83	0.80	3/4	0.18	2902 0020
3/8	7/16	1.41	0.69	0.98	1.01	1	0.32	2902 0024
7/16	1/2	1.70	0.72	1.06	1.13	1-1/2	0.45	2902 0028
1/2	5/8	1.83	0.83	1.18	1.25	2	0.68	2902 0032
5/8	3/4	2.36	1.06	1.55	1.67	3-1/4	1.36	2902 0040
3/4	7/8	2.76	1.24	1.78	1.98	4-3/4	2.24	2902 0048
7/8	1	3.29	1.42	2.09	2.25	6-1/2	3.50	2902 0056
1	1-1/8	3.69	1.75	2.35	2.66	8-1/2	5.00	2902 0100
1-1/8	1-1/4	4.23	1.80	2.71	2.79	9-1/2	7.65	2902 0108
1-1/4	1-3/8	4.63	2.12	3.01	3.15	12	10.40	2902 0116
1-3/8	1-1/2	5.17	2.30	3.32	3.60	13-1/2	13.80	2902 0124
1-1/2	1-5/8	5.67	2.39	3.63	3.85	17	17.90	2902 0132
1-3/4	2	7.06	2.96	4.23	4.99	25	27.90	2902 0148
2	2-1/4	7.75	3.31	5.11	5.59	35	42.70	2902 0200
2-1/2	2-3/4	10.25	4.00	5.75	7.00	55	85.00	2902 0232

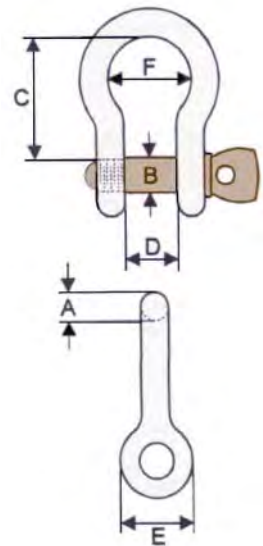

* Additional sizes available upon request, minimum order quantity may apply.

Note: If the pin, after a 1/4 turn, remains hard to remove, there is a good chance that the shackle has been overloaded beyond the designed working load limit (WLL) and it, therefore, must be discarded.

Warning: **NEVER EXCEED WORKING LOAD LIMIT!**
Failure to follow instructions can result in serious property damage, injury or death!

- For more information please see the shackle warning information found in the hardware section of this catalogue

WIRE ROPE HARDWARE

'GOLDEN PIN'® BOLT TYPE ANCHOR SHACKLES

- Meet the performance requirements of U.S. Fed. Spec. RR-C-271D, Type 4A, Grade A, Class 3
- Heat treated carbon steel bows, quenched and tempered with Alloy pins
- Hot dipped galvanized
- Metallic coating of shackle pins allows for closer thread tolerances than possible for shackles with an extra layer of paint
- Recommended for long term service installation as well as for applications where there is the possibility that the pin can rotate under load
- Design factor 6:1



To assure total traceability and to exceed the requirements of ASME B30.26

'Golden Pin' shackles bodies are embossed with:

- Vanguard
- WLL (working load limit)
- Size
- Trace Code

'Golden Pin' shackles pins are stamped with:

- Vanguard I.D. (VGD®)
- Alloy Pin I.D.WLL (HS)
- Yellow chromated for instant recognition
- Trace Code

Size	Pin Diameter	Dimensions (inches)				WLL (tons)	Weight (lbs)	Vanguard Code
		A	B	C	F			
1/4	5/16	1.14	0.50	0.67	0.77	1/2	0.13	2914 0016
5/16	3/8	1.22	0.54	0.83	0.83	3/4	0.21	2914 0020
3/8	7/16	1.41	0.66	1.00	0.99	1	0.36	2914 0024
7/16	1/2	1.72	0.75	1.03	1.12	1-1/2	0.47	2914 0028
1/2	5/8	1.87	0.84	1.19	1.16	2	0.80	2914 0032
5/8	3/4	2.38	1.06	1.58	1.68	3-1/4	1.61	2914 0040
3/4	7/8	2.82	1.27	1.80	1.99	4-3/4	2.45	2914 0048
7/8	1	3.33	1.44	2.09	2.27	6-1/2	3.85	2914 0056
1	1-1/8	3.75	1.72	2.38	2.68	8-1/2	5.65	2914 0100
1-1/8	1-1/4	4.21	1.89	2.72	2.91	9-1/2	8.52	2914 0108
1-1/4	1-3/8	4.67	2.24	2.98	3.20	12	11.10	2914 0116
1-3/8	1-1/2	5.25	2.51	3.32	3.62	13-1/2	14.88	2914 0124
1-1/2	1-5/8	5.70	2.68	3.60	3.82	17	19.30	2914 0132
1-3/4	2	7.00	3.07	4.24	4.65	25	30.45	2914 0148
2	2-1/4	7.85	3.25	5.05	5.77	35	46.63	2914 0200

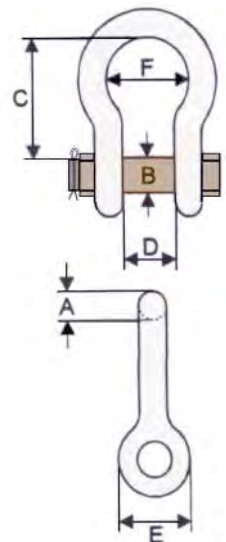

* Additional sizes available upon request, minimum order quantity may apply.

Note:

If the pin, after a 1/4 turn, remains hard to remove, there is a good chance that the shackle has been overloaded beyond the designed working load limit (WLL) and it, therefore, must be discarded.

Warning:

NEVER EXCEED WORKING LOAD LIMIT!

Failure to follow instructions can result in serious property damage, injury or death!

- For more information please see the shackle warning information found in the hardware section of this catalogue

'GOLDEN PIN'® SCREW PIN CHAIN SHACKLES

- Meet the performance requirements of U.S. Fed. Spec. RR-C-271D, Type 4A, Grade A, Class 2
- Heat treated carbon steel bows, quenched and tempered with Alloy pins
- Hot dipped galvanized
- Metallic coating of shackle pins allows for closer thread tolerances than possible for shackles with an extra layer of paint
- Design factor 6:1



To assure total traceability and to exceed the requirements of ASME B30.26 'Golden Pin' shackles bodies are embossed with:

- Vanguard
- WLL (working load limit)
- Size
- Trace Code

'Golden Pin' shackles pins are stamped with:

- Vanguard I.D. (VGD®)
- Alloy Pin I.D.WLL (HS)
- Yellow chromated for instant recognition
- Trace Code

Size	Pin Diameter	Dimensions (inches)			WLL (tons)	Weight (lbs)	Vanguard Code
		A	B	E			
1/4	5/16	0.83	0.47	0.71	1/2	0.11	3912 0016
5/16	3/8	0.98	0.47	0.75	3/4	0.17	3912 0020
3/8	7/16	1.22	0.63	0.96	1	0.24	3912 0024
7/16	1/2	1.50	0.75	1.06	1-1/2	0.40	3912 0028
1/2	5/8	1.61	0.83	1.22	2	0.59	3912 0032
5/8	3/4	2.01	1.10	1.57	3-1/4	1.20	3912 0040
3/4	7/8	2.41	1.25	1.81	4-3/4	2.20	3912 0048
7/8	1	2.80	1.42	2.13	6-1/2	3.20	3912 0056
1	1-1/8	3.15	1.77	2.36	8-1/2	4.80	3912 0100
1-1/8	1-1/4	3.50	1.85	2.69	9-1/2	6.80	3912 0108
1-1/4	1-3/8	3.97	2.05	3.00	12	9.00	3912 0116
1-1/2	1-5/8	4.80	2.39	3.68	17	16.00	3912 0132
2	2-1/4	6.75	3.25	5.00	35	43.00	3912 0200

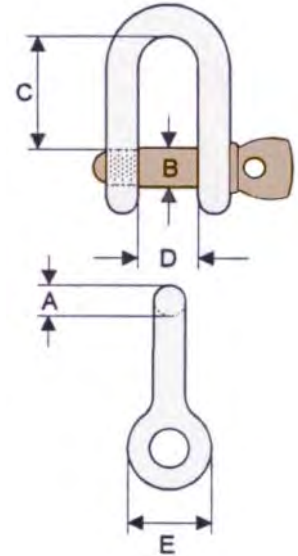

* Additional sizes available upon request, minimum order quantity may apply.

Note:

If the pin, after a 1/4 turn, remains hard to remove, there is a good chance that the shackle has been overloaded beyond the designed working load limit (WLL) and it, therefore, must be discarded.

Warning:

NEVER EXCEED WORKING LOAD LIMIT!

Failure to follow instructions can result in serious property damage, injury or death!

- For more information please see the shackle warning information found in the hardware section of this catalogue

WIRE ROPE HARDWARE

'SILVER PIN'[®] SCREW PIN ANCHOR SHACKLES

- Meet the performance requirements of U.S. Fed. Spec. RR-C-271D, Type 4A, Grade A, Class 2
- Heat treated carbon steel bows, quenched and tempered with Alloy pins
- Hot dipped galvanized
- Shackles bodies embossed with size, WLL and trace code
- Design factor 6:1

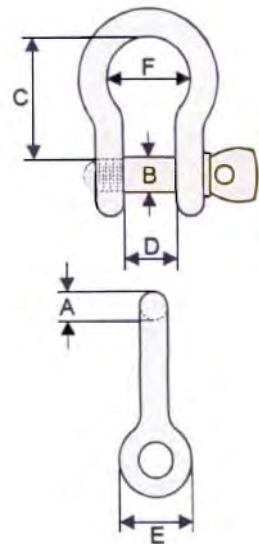

Size	Pin Diameter	Dimensions (inches)				WLL (tons)	Weight (lbs)	Vanguard Code
		A	B	C	D			
3/16	1/4	0.93	0.39	0.59	0.64	1/3	0.06	2902 5012
1/4	5/16	1.14	0.49	0.70	0.75	1/2	0.12	2902 5016
5/16	3/8	1.23	0.53	0.83	0.80	3/4	0.18	2902 5020
3/8	7/16	1.41	0.69	0.98	1.01	1	0.32	2902 5024
7/16	1/2	1.70	0.72	1.06	1.13	1-1/2	0.45	2902 5028
1/2	5/8	1.83	0.83	1.18	1.25	2	0.68	2902 5032
5/8	3/4	2.36	1.06	1.55	1.67	3-1/4	1.36	2902 5040
3/4	7/8	2.76	1.24	1.78	1.98	4-3/4	2.24	2902 5048
7/8	1	3.29	1.42	2.09	2.25	6-1/2	3.50	2902 5056
1	1-1/8	3.69	1.75	2.35	2.66	8-1/2	5.00	2902 5100
1-1/8	1-1/4	4.23	1.80	2.71	2.79	9-1/2	7.65	2902 5108
1-1/4	1-3/8	4.63	2.12	3.01	3.15	12	10.40	2902 5116
1-3/8	1-1/2	5.17	2.30	3.32	3.60	13-1/2	13.80	2902 5124
1-1/2	1-5/8	5.67	2.39	3.63	3.85	17	17.90	2902 5132
1-3/4	2	7.06	2.96	4.23	4.99	25	27.90	2902 5148
2	2-1/4	7.75	3.31	5.11	5.59	35	42.70	2902 5200
2-1/2	2-3/4	10.25	4.00	5.75	7.00	55	85.00	2902 5232

* Additional sizes available upon request, minimum order quantity may apply.

Note:

If the pin, after a 1/4 turn, remains hard to remove, there is a good chance that the shackle has been overloaded beyond the designed working load limit (WLL) and it, therefore, must be discarded.

Warning:

NEVER EXCEED WORKING LOAD LIMIT!

Failure to follow instructions can result in serious property damage, injury or death!

- For more information please see the shackle warning information found in the hardware section of this catalogue

STAINLESS SCREW PIN ANCHOR SHACKLES

- To be used for light duty, non-critical applications only
- Made from AISI 316 stainless steel
- Bright polished finish
- Cast

Size	Dimensions (inches)						WLL (tons)	Nominal Breaking Strength (lbs)	Vanguard Code
	A	B	C	D	E	F			
3/16	0.19	0.25	0.88	0.38	0.56	0.60	1/4	4,404	3913 0012
1/4	0.25	0.31	1.13	0.47	0.61	0.78	1/4	6,612	3913 0016
5/16	0.31	0.38	1.22	0.53	0.75	0.84	1/3	9,918	3913 0020
3/8	0.38	0.44	1.44	0.66	0.91	1.03	1/2	13,224	3913 0024
7/16	0.44	0.50	1.69	0.75	1.06	1.16	2/3	19,836	3913 0028
1/2	0.50	0.63	1.88	0.81	1.19	1.31	1	26,454	3913 0032
5/8	0.63	0.75	2.38	1.06	1.50	1.69	1-1/2	42,990	3913 0040
3/4	0.75	0.88	2.81	1.25	1.81	2.00	2-1/4	62,826	3913 0048
7/8	0.88	1.00	3.31	1.44	2.09	2.28	3	57,269	3913 0056
1	1.00	1.13	3.75	1.69	2.38	2.69	4	74,890	3913 0100

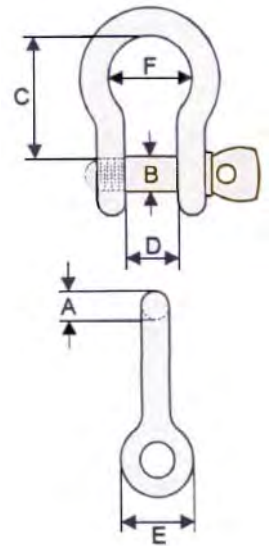

* Additional sizes available upon request, minimum order quantity may apply.

Note: If the pin, after a 1/4 turn, remains hard to remove, there is a good chance that the shackle has been overloaded beyond the designed working load limit (WLL) and it, therefore, must be discarded.

Warning: **NEVER EXCEED WORKING LOAD LIMIT!**
Failure to follow instructions can result in serious property damage, injury or death!

- For more information please see the shackle warning information found in the hardware section of this catalogue

WIRE ROPE HARDWARE



HOIST HOOKS

- Forged Carbon or Alloy Steel, quenched & tempered
- Embossed Working Load Limit (WLL) with 5:1 safety factor
- Colour coding prevents mix-ups
- Carbon Steel - black eye, red body
- Alloy Steel - black eye, gold body



WLL (tons)		Dimensions (inches)										Weight (lbs)	Vanguard Code	
Carbon	Alloy	A	B	C	D	E	F	G	H	I	J		Carbon	Alloy
1/2		0.56	0.62	0.35	0.75	0.53	0.76	2.55	0.75	3.83	2.75	0.38	2910 0005	
3/4	1	1.50	0.75	0.38	0.88	0.63	0.94	2.88	0.75	4.38	3.25	0.50	2910 0007	2910 1010
1	1-1/2	1.75	0.88	0.44	1.00	0.69	1.06	3.13	0.81	4.88	3.63	0.80	2910 0010	2910 1015
1-1/2	2	2.00	1.13	0.50	1.19	0.81	1.12	3.50	1.00	5.50	4.13	1.10	2910 0015	2910 1020
2	3	2.38	1.25	0.59	1.38	0.94	1.22	3.94	1.19	6.31	4.56	1.70	2910 0020	2910 1030
3	4-1/2	3.00	1.56	0.69	1.63	1.19	1.50	5.00	1.50	7.94	5.75	3.60	2910 0030	2910 1045
5	7	3.81	2.00	0.88	2.06	1.50	1.88	6.25	1.75	10.00	7.38	7.00	2910 0050	2910 1070
7-1/2	11	4.70	2.43	1.19	2.53	1.68	2.23	7.25	2.37	12.25	9.00	13.27	2910 0075	2910 1110

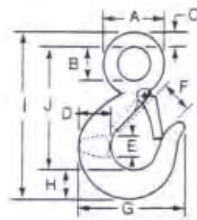

SWIVEL HOOKS

- Forged Carbon or Alloy Steel, quenched & tempered
- Embossed Working Load Limit (WLL) with:
5:1 safety factor for Carbon hooks
4.5:1 safety factor for Alloy hooks



WLL (tons)		Dimensions (inches)										Approx. Weight (lbs)	Vanguard Code	
Carbon	Alloy	A	B	C	D	E	F	G	H	I	J		Carbon	Alloy
3/4	1	1.23	0.92	0.40	0.83	0.60	0.98	2.95	0.86	5.50	4.35	0.55	2928 0010	2928 1010
1	1-1/2	1.50	1.35	0.52	0.94	0.66	1.07	3.33	0.86	6.50	5.23	0.75	2928 0011	2928 1015
1-1/2	2	1.73	1.70	0.64	1.13	0.75	1.10	3.75	1.04	7.50	6.00	1.25	2928 0015	2928 1020
2	3	1.70	1.60	0.64	1.36	0.87	1.21	4.25	1.20	8.00	6.25	1.70	2928 0020	2928 1030
3	4-1/2	1.95	1.84	0.78	1.66	1.11	1.52	5.00	1.55	9.50	7.50	3.60	2928 0030	2928 1045
5	7	2.42	2.42	1.02	2.10	1.35	2.04	7.00	1.99	11.75	9.75	7.08	2928 0050	2928 1070
7-1/2	11	2.70	2.51	1.10	2.65	1.75	2.40	8.00	2.45	14.50	11.12	13.00	2928 0075	2928 1110
	15	4.10	3.76	1.50	3.50	2.69	3.41	10.34	3.00	21.34	16.71	22.00		2928 1150
	22	4.10	3.76	1.50	4.63	3.00	4.00	13.62	3.61	23.25	18.01	41.00		2928 1220

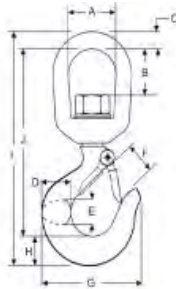

STAINLESS LATCH KITS (FOR HOIST HOOKS)

WLL (tons)		Vanguard Code	WLL (tons)		Vanguard Code
Carbon	Alloy		Carbon	Alloy	
3/4	1	29190010	3	4-1/2	2919 0030
1	1-1/2	29190011	5	7	2919 0050
1-1/2	2	29190021	7-1/2	11	2919 0075
2	3	29190022		15	2919 1509
				22	2919 2209

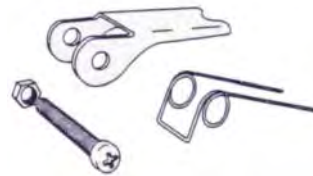

Warning:

NEVER EXCEED WORKING LOAD LIMITS!

- Swivels are designed for positioning only and should not rotate under load
- Inspect hooks and latches frequently and discard hooks which show signs of deformation or excessive wear
- Latches are not designed to support loads - replace bent latches
- Always use thimbles to install hooks onto a rope
- Recommended maximum Proof Load: 2 x WLL

STANDARD WIRE ROPE THIMBLES

- Manufactured to U.S. Fed. Spec. FF-T-276B, Type II
- For light duty applications with fibre or wire ropes to protect rope eyes against cuts and abrasions
- Electroplated zinc coating

Size	Dimensions (inches)					Weight (lbs/100)	Vanguard Code
	A	B	C	D	E		
1/8	1.92	1.18	1.33	0.70	0.19	3	2905 0008
3/16	1.92	1.13	1.38	0.72	0.24	3	2905 0012
1/4	1.95	1.09	1.38	0.71	0.29	3	2905 0016
5/16	2.11	1.22	1.52	0.81	0.36	4	2905 0020
3/8	2.25	1.43	1.70	0.94	0.40	6	2905 0024
1/2	2.70	1.78	1.85	1.18	0.61	10	2905 0032
5/8	3.48	2.32	2.32	1.37	0.74	32	2905 0040
3/4	3.72	2.70	2.58	1.61	0.81	48	2905 0048
7/8	4.97	3.08	3.54	1.89	1.00	76	2905 0056
1	5.57	3.72	4.13	2.52	1.07	92	29050100

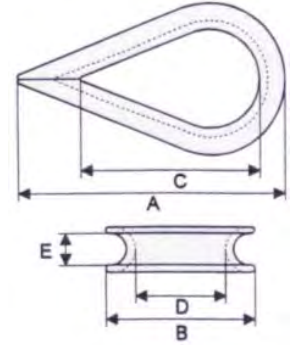

HEAVY WIRE ROPE THIMBLES

- Manufactured to U.S. Fed. Spec. FF-T-276B, Type III
- Made from cold rolled steel, hot dip galvanized, for protection of rope eyes in demanding applications
- Also available in Stainless Steel where corrosive elements call for greater protection

Size	Dimensions (inches)					Weight (lbs/100)	Vanguard Code	
	A	B	C	D	E		Galvanized	Stainless Steel
1/4	2.22	1.49	1.65	0.89	0.32	6	2906 0016	2961 0016
5/16	2.53	1.82	1.88	1.08	0.40	11	2906 0020	2961 0020
3/8	2.89	2.06	2.11	1.14	0.53	21	2906 0024	2961 0024
7/16	3.25	2.32	2.39	1.24	0.55	27	2906 0028	2961 0028
1/2	3.63	2.70	2.86	1.47	0.60	51	2906 0032	2961 0032
9/16	3.53	2.77	2.66	1.53	0.56	51	2906 0036	2961 0036
5/8	4.26	3.07	3.33	1.75	0.76	69	2906 0040	2961 0040
3/4	5.09	3.73	3.68	2.04	0.95	153	2906 0048	2961 0048
7/8	5.66	4.05	4.32	2.19	1.09	187	2906 0056	2961 0056
1	6.56	4.50	4.80	2.32	1.25	248	2906 0100	2961 0100
1-1/8	7.00	5.53	5.17	2.99	1.50	332	2906 0108	2961 0108
1-1/4	9.00	6.50	7.50	3.20	1.64	816	2906 0116	2961 0116
1-3/8 - 1-1/2	9.00	6.75	7.50	3.30	1.90	1,040	2906 0124	2961 0124
1-3/4	12.00	8.11	8.64	4.10	1.50	1,510	2906 0148	2961 0148
2	15.30	9.90	11.90	6.03	2.00	2,170	2906 0200	2961 0200

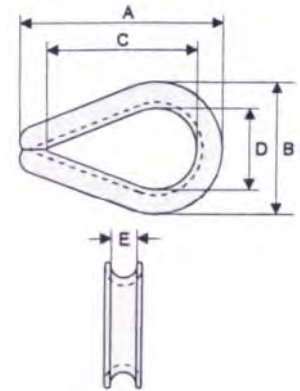

Warning:

Thimbles are not designed to support loads!

WIRE ROPE HARDWARE

STAINLESS AN - THIMBLES

- For applications using small diameter galvanized or stainless cables

Size	Item No.	Dimensions (inches)						Weight (lbs/100)	Vanguard Code
		A	B	C	D	E	F		
3/64 - 1/16 - 5/64	C-3	0.350	0.671	0.187	0.093	0.032	0.078	0.15	2960 0004
3/32 - 1/8 - 7/64	C-4	0.350	0.671	0.218	0.140	0.032	0.078	0.43	2960 0006
5/32	C-5	0.400	0.796	0.218	0.171	0.032	0.109	0.60	2960 0010
3/16	C-6	0.500	1.000	0.312	0.203	0.032	0.171	0.98	2960 0012
1/4	C-8	0.700	1.406	0.406	0.265	0.032	0.171	1.50	2960 0016
5/16	C-10	0.900	1.796	0.437	0.328	0.040	0.218	3.50	2960 0020
3/8	C-12	1.000	2.000	0.625	0.390	0.060	0.265	8.50	2960 0024

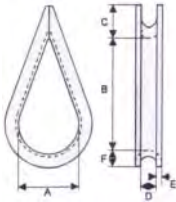

OVAL SLEEVES

- Available in aluminum, copper, zinc plated, and stainless steel (see prefix*)

Cable Size	Aluminum Dimensions (inches)			Copper Dimensions (inches)			Weight (lbs/100)		Vanguard Suffix Code*
	A	B	C	A	B	C	Alum	Copper	
3/64	0.135	0.195	0.375	0.130	0.200	0.375	0.06	0.20 0003
1/16	0.175	0.250	0.375	0.170	0.250	0.375	0.08	0.25 0004
3/32	0.250	0.360	0.484	0.230	0.370	0.375	0.25	0.60 0006
1/8	0.340	0.485	0.625	0.330	0.490	0.563	0.58	1.00 0008
5/32	0.390	0.560	0.750	0.360	0.590	0.625	0.70	2.30 0010
3/16	0.455	0.660	0.875	0.440	0.670	0.938	1.45	5.30 0012
1/4	0.540	0.810	1.000	0.515	0.815	1.125	2.80	7.00 0016
5/16	0.655	0.990	1.375	0.665	1.015	1.063	4.10	12.20 0020
3/8	0.775	1.200	1.438	0.735	1.125	1.250	5.70	15.60 0024
7/16	0.937	1.437	1.938				11.60	 0028
1/2	1.062	1.625	2.000				17.20	 0032

Prefix*	
Aluminum	2950
Copper	2952
Zinc Plated	2954
Stainless Steel	2955

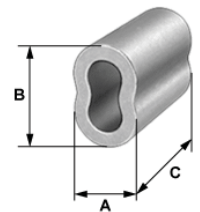

STOP SLEEVES

- Available in aluminum or copper (see prefix*)

Cable Size	Aluminum Dimensions (inches)		Copper Dimensions (inches)		Weight (lbs/100)		Vanguard Suffix Code*
	A	B	A	B	Alum	Copper	
1/16	0.219	0.188	0.203	0.219	0.04	0.20 0004
3/32	0.344	0.313	0.328	0.313	0.25	0.80 0006
1/8	0.344	0.313	0.328	0.313	0.23	0.70 0008
5/32	0.406	0.313	0.422	0.313	0.40	1.20 0010
3/16	0.438	0.313	0.422	0.313	0.35	1.05 0012
1/4	0.656	0.688	0.656	0.688	2.10	6.10 0016
5/16	0.688	0.688	0.656	0.688		 0020
3/8			0.656	0.688		 0024

Prefix*	
Aluminum	2951
Copper	2953

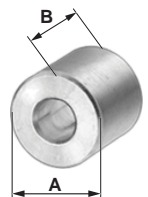

Note:

Properly swaged, **oval sleeves** are capable of maintaining over 90% of the breaking strength of the cable. However, to determine the exact holding strength, a pull test must be performed prior to use. The maximum holding strength of **stop sleeves** is approximately 1/3 of the strength of the cable. **Safety Margins must be maintained in line with the respective applications.**

FORGED EYE BOLT WARNINGS AND INFORMATION

It is very important to read and understand all information shown before using eye bolts



Shoulder Nut Eye Bolt



Regular Nut Eye Bolt



Machinery Eye Bolt

Shoulder nut and/or machinery eye bolts are recommended for rigging hardware, except when prohibited by the configuration of the item that the eye bolts are attached to.

Where non-shoulder eye bolts are required, they should only be used for vertical pulls or in rigging systems designed, analyzed and approved by a properly qualified/competent person.

For vertical loading eye bolts without shoulders have the same load-carrying capacity/ability as shoulder eye bolts

WARNING

FAILURE TO OBSERVE THESE WARNINGS MAY RESULT IN SERIOUS INJURY OR DEATH!

- **ALWAYS** inspect eye bolts before use, checking for wear, damage, bent or elongation of the eye and/or shank and damage to the threads. The inspection should be performed by a properly trained/competent person
- **ALWAYS** make sure that the threads on the shank and the receiving hole are clean before use
- **ALWAYS** apply load to the eye bolt in the plane of the eye not at an angle
- **ALWAYS** tighten nuts securely against the load
- **NEVER** lift or transport loads over or near people
- **NEVER** exceed the rate capacity (WLL) of any component
- **NEVER** insert the tip of a hook into an eye bolt, use a 'Golden Pin'® shackle to avoid loading the hook tip
- **NEVER** machine, cut, grind or in any way alter eye bolts
- **NEVER** use eye bolts which show signs of wear or deformation
- **NEVER** use regular nut eye bolts for angular lifts. Only shoulder nut or machinery eye bolts should be used and observe WLL capacity adjustment information

REEVING OF A SLING THROUGH AN EYE BOLT

Slings should never be reeved through an eye bolt or through a pair of eye bolts. Reeving will alter the angle of the loading on the eye bolts. Only one leg should be attached to each eye bolt.

After properly attaching the slings to the eye bolts, slowly lift the load. Watch the load carefully and be prepared to stop lifting the load if it starts to buckle.

Buckling can occur if the load is not stiff enough to resist the compressive forces which result from the angular loading.

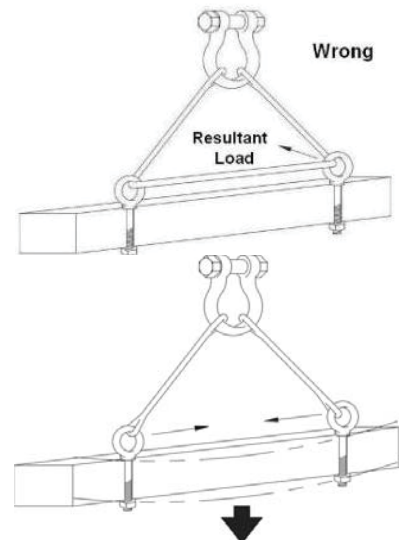

FORGED EYE BOLT WARNINGS AND INFORMATION

It is very important to read and understand all information shown before using eye bolts

CAPACITY ADJUSTMENT FOR ANGULAR LOADING

Lift Angle in-line pull	Maximum Load
45°	30% of the working load limit (WLL)
90°	25% of the working load limit (WLL)

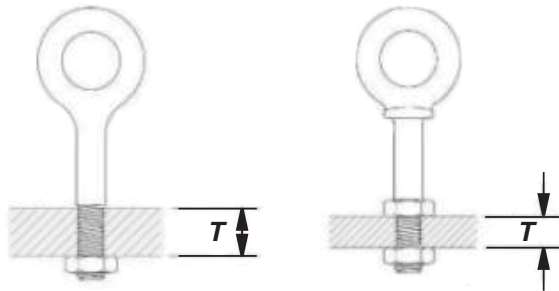
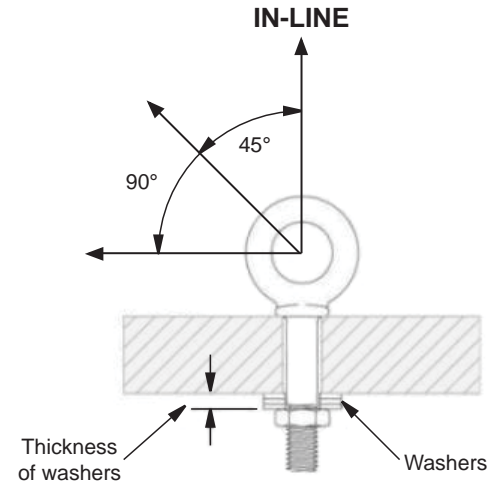

EYE BOLT INSTALLATION

Use one nut if the thickness is more than one eye bolt diameter ($T >$). Use two nuts if the thickness is less than or equal to the eye bolt diameter ($T \leq$) as shown.

Always tighten nut securely against the load.

INSTALLATION FOR ANGULAR LOADING

Use shoulder nut eye bolts for angular loading. If the eye bolt protrudes so far through the load that the nut cannot be tightened securely against the load, use properly sized washers/spacer to take up the excess space between the nut and the load (as shown). The thickness of the washers/spacer must exceed the distance between the bottom of the load and the last thread of the eye bolt.

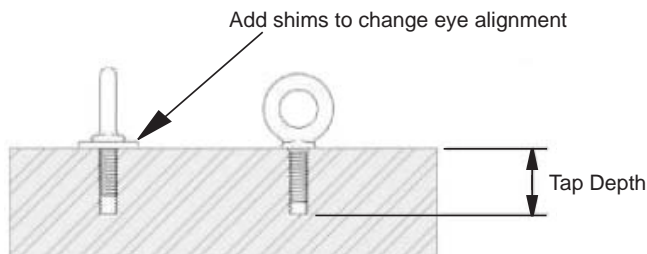
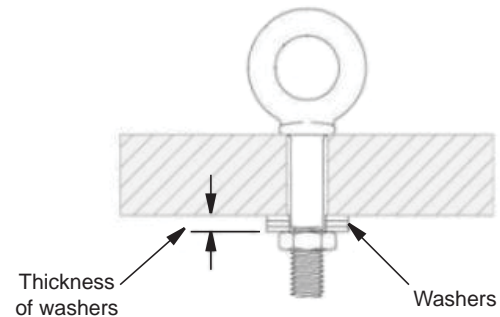

INSTALLATION OF MACHINERY EYE BOLTS

These eye bolts are primarily intended to be installed in tapped holes. For installation, tap the load (tap depth) to a minimum depth of one-half the eye bolt size beyond the shank length of the machinery eye bolt.

If the plane of the machinery eye bolt is not aligned with the sling line, add shims (washers/spacers) of proper thickness to adjust the angle of the plane of the eye to match the sling line (as shown).

SHOULDER NUT EYE BOLTS

- Permanently embossed with VGD© and size for traceability to meet ASME B30.26
- Forged carbon steel
- Quenched and tempered
- Hot dipped galvanized with heavy hex nut
- UNC Threads
- Design factor proof load 2:1 WLL, ultimate load 5:1 WLL

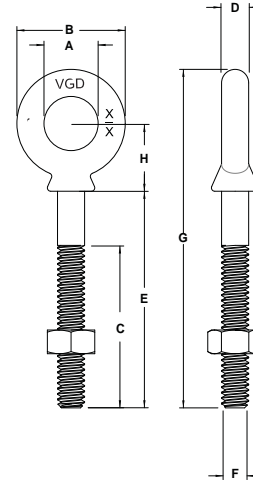

Size (inches)	Dimensions (inches)								WLL (lbs)	Weight (lbs)	Vanguard Code
	A	B	C	D	E	F	G	H			
1/4 X 2	0.496	0.887	1.638	0.198	2.025	0.235	2.953	0.485	650	0.06	2971 1020
1/4 X 4	0.502	0.898	2.727	0.205	4.013	0.235	4.970	0.503	650	0.08	2971 1040
5/16 X 2-1/4	0.614	1.138	1.565	0.240	2.295	0.302	3.542	0.678	1,200	0.11	2971 2022
5/16 X 4-1/4	0.620	1.153	2.644	0.246	4.278	0.309	5.568	0.714	1,200	0.16	2971 2042
3/8 X 2-1/2	0.736	1.361	1.667	0.322	2.525	0.364	3.997	0.792	1,550	0.17	2971 3025
3/8 X 4-1/2	0.762	1.384	2.551	0.325	4.465	0.369	5.979	0.822	1,550	0.25	2971 3045
1/2 X 3-1/4	0.983	1.769	1.605	0.412	3.217	0.487	5.165	1.064	2,600	0.40	2971 4032
1/2 X 6	0.995	1.780	3.021	0.425	6.005	0.482	8.000	1.105	2,600	0.53	2971 4060
5/8 X 4	1.267	2.317	2.158	0.549	4.154	0.605	6.563	1.251	5,200	0.78	2971 5040
5/8 X 6	1.264	2.303	3.094	0.572	6.082	0.609	8.500	1.267	5,200	0.81	2971 5060
3/4 X 4-1/2	1.514	2.817	2.162	0.721	4.505	0.719	7.489	2.576	7,200	1.41	2971 6045
3/4 X 6	1.516	2.802	3.092	0.732	5.985	0.721	9.000	1.614	7,200	1.51	2971 6060
1 X 6	1.995	3.983	3.102	0.983	6.452	0.975	10.500	2.057	13,300	3.20	2971 7060

Warning:

**NEVER EXCEED WORKING LOAD LIMITS
WORKING LOAD LIMITS PERTAIN TO IN-LINE PULLS ONLY**

- NEVER use eye bolts which show signs of wear or deformation

WIRE ROPE HARDWARE

REGULAR NUT EYE BOLTS

- Permanently embossed with VGD© and size for traceability to meet ASME B30.26
- Forged carbon steel
- Quenched and tempered
- Hot dipped galvanized with heavy hex nut
- UNC Threads
- Design factor proof load 2:1 WLL, ultimate load 5:1 WLL

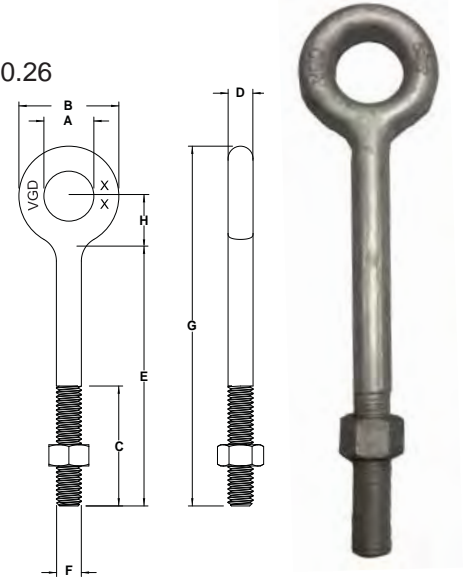

Size (inches)	Dimensions (inches)								WLL (lbs)	Weight (lbs)	Vanguard Code
	A	B	C	D	E	F	G	H			
5/16 X 4-1/4	0.625	1.253	2.673	0.302	4.285	0.304	5.583	0.672	1,200	0.16	2970 2042
3/8 X 2-1/2	0.745	1.515	1.556	0.387	2.512	0.362	4.052	0.783	1,550	0.19	2970 3025
3/8 X 4-1/2	0.762	1.502	2.598	0.396	4.496	0.366	6.025	0.778	1,550	0.25	2970 3045
3/8 X 6	0.761	1.498	2.500	0.401	5.960	0.359	7.470	0.761	1,550	0.30	2970 3060
1/2 X 3-1/4	0.973	2.028	1.598	0.537	3.361	0.489	5.445	0.980	2,600	0.51	2970 4032
1/2 X 6	0.971	2.022	3.150	0.544	6.046	0.489	8.100	0.953	2,600	0.63	2970 4060
1/2 X 8	0.992	2.038	3.161	0.541	8.250	0.497	10.250	0.981	2,600	0.76	2970 4080
1/2 X 10	0.995	2.031	3.169	0.535	10.250	0.494	12.250	0.985	2,600	0.87	2970 4100
1/2 X 12	1.002	2.029	3.340	0.532	12.250	0.492	14.250	0.984	2,600	1.00	2970 4120
5/8 X 4	1.257	2.517	2.264	0.641	4.125	0.602	6.675	1.292	5,200	0.94	2970 5040
5/8 X 6	1.267	2.514	3.185	0.646	6.213	0.605	8.750	1.281	5,200	1.13	2970 5060
5/8 X 8	1.251	2.508	3.183	0.632	8.250	0.610	10.750	1.246	5,200	1.32	2970 5080
5/8 X 10	1.252	2.509	3.230	0.630	10.250	0.608	12.750	1.245	5,200	1.49	2970 5100
5/8 X 12	1.254	2.501	3.971	0.638	12.250	0.603	14.750	1.250	5,200	1.59	2970 5120
3/4 X 4-1/2	1.483	2.967	2.094	0.751	4.750	0.734	7.844	1.611	7,200	1.51	2970 6045
3/4 X 6	1.484	2.959	3.370	0.752	6.348	0.737	9.350	1.523	7,200	1.82	2970 6060
3/4 X 8	1.485	2.975	3.189	0.761	8.400	0.735	11.400	1.513	7,200	1.95	2970 6080
3/4 X 10	1.477	2.974	2.915	0.765	10.250	0.728	13.250	1.514	7,200	2.08	2970 6100
3/4 X 12	1.473	2.965	4.320	0.762	12.250	0.725	15.250	1.517	7,200	2.77	2970 6120
1 X 6	1.978	3.972	3.008	0.977	6.500	0.965	10.500	2.014	13,300	3.23	2970 7060
1 X 12	1.965	3.984	4.379	0.975	12.500	0.973	16.500	2.008	13,300	4.68	2970 7120

Warning:

**NEVER EXCEED WORKING LOAD LIMITS
WORKING LOAD LIMITS PERTAIN TO IN-LINE PULLS ONLY**

- NEVER use eye bolts which show signs of wear or deformation

MACHINED EYE BOLTS

- Permanently embossed with trace code, VGD© and size for traceability to meet ASME B30.26
- Forged carbon steel
- Quenched and tempered
- UNC Threads
- Design factor proof load 2:1 WLL, ultimate load 5:1 WLL

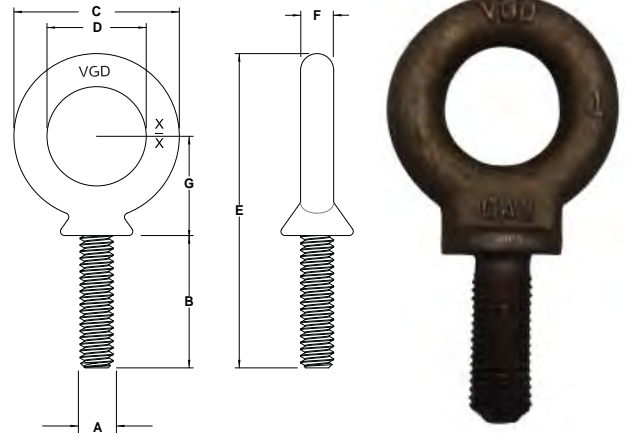

Size (inches)	Dimensions (inches)							WLL (lbs)	Proof Load (lbs)	Weight (lbs)	Vanguard Code
	A	B	C	D	E	F	G				
1/4 X 1	0.235	1.005	1.211	0.773	2.388	0.232	0.778	650	1,300	0.05	2975 1010
5/16 X 1-1/8	0.293	1.227	1.435	0.880	2.849	0.284	0.905	1,200	2,400	0.09	2975 2011
3/8 X 1-1/4	0.367	1.245	1.717	0.928	3.310	0.377	1.207	1,550	3,100	0.15	2975 3012
1/2 X 1-1/2	0.487	1.472	2.145	1.158	3.967	0.466	1.423	2,600	5,200	0.28	2975 4015
5/8 X 1-3/4	0.612	1.791	2.587	1.376	4.739	0.639	1.655	5,200	10,400	0.55	2975 5017
3/4 X 2	0.743	1.976	2.845	1.492	5.297	0.691	1.899	7,200	14,400	0.96	2975 6020
7/8 X 2-1/4	0.859	2.252	3.228	1.685	5.945	0.798	2.079	10,600	21,200	1.54	2975 7022
1 X 2-1/2	0.993	2.414	3.563	1.774	6.551	0.943	2.356	13,300	26,600	2.38	2975 9025
1-1/4 X 3	1.229	2.995	4.328	2.245	7.733	1.070	2.574	21,000	42,000	3.99	2975 9030
1-1/2 X 3-1/2	1.465	3.449	5.366	2.832	9.250	1.347	3.118	24,000	48,000	7.20	2975 9035

Warning:

**NEVER EXCEED WORKING LOAD LIMITS
WORKING LOAD LIMITS PERTAIN TO IN-LINE PULLS ONLY**

- NEVER use eye bolts which show signs of wear or deformation

WIRE ROPE HARDWARE

SCREW EYE BOLTS

- Forged Carbon Steel, quenched & tempered, hot dip galvanized

Diameter (A)	Dimensions (inches)				Weight (lbs)	Vanguard Code
	B	C	D	E		
1/4	1.98	1.53	0.46	0.92	0.06	2973 1020
5/16	2.39	1.88	0.62	1.15	0.09	2973 2025
3/8	2.69	2.00	0.75	1.42	0.17	2973 3025
1/2	3.34	2.54	0.94	1.74	0.34	2973 4032
5/8	4.00	3.34	1.21	2.27	0.69	2973 5040

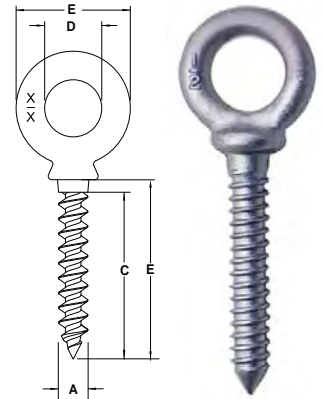

FORGED EYE NUTS

- Permanently embossed with trace code, VGD© and size for traceability to meet ASME B30.26
- Forged carbon steel
- Quenched and tempered
- Hot dipped galvanized
- UNC Threads
- Design factor proof load 2:1 WLL, ultimate load 5:1 WLL

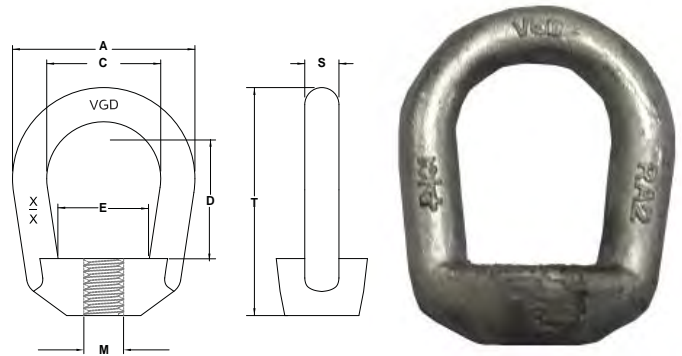

Size	Dimensions (inches)									WLL (lbs)	Weight (lbs)	Vanguard Code
	Nominal	Tap Size	A	C	D	E	S	T	M			
1	1/4	1/4	1.282	0.745	1.032	0.628	0.254	1.678	0.229	520	0.09	2974 0016
2	5/16	3/8	1.602	0.965	1.212	0.748	0.325	2.072	0.314	1,250	0.18	2974 0020
3	3/8	1/2	2.005	1.232	1.478	0.975	0.394	2.513	0.425	2,250	0.28	2974 0024
4	1/2	5/8	2.523	1.488	1.947	1.186	0.517	3.242	0.538	3,600	0.58	2974 0032
5	5/8	3/4	3.004	1.732	2.425	1.328	0.645	3.882	0.665	5,200	1.00	2974 0040
6	3/4	7/8	3.507	1.991	2.642	1.588	0.778	4.334	0.766	7,200	1.70	2974 0048
7	7/8	1	3.894	2.232	3.015	1.804	0.827	4.952	0.887	10,000	2.75	2974 0056
8	1	1-1/4	4.505	2.476	3.503	1.925	1.020	5.763	1.101	15,500	3.90	2974 0100
10	1-1/4	1-1/2	5.615	3.098	4.025	2.372	1.254	6.738	1.356	22,500	6.70	2974 0116
11	1-1/2	2	7.175	3.990	6.133	3.957	1.585	10.250	1.790	40,000	18.70	2974 0132

Note: order by tap size, markings on the eye nut are for the body stock size

Warning:

**NEVER EXCEED WORKING LOAD LIMITS
WORKING LOAD LIMITS PERTAIN TO IN-LINE PULLS ONLY**

- NEVER use eye bolts which show signs of wear or deformation

FORGED EYE & EYE SWIVELS

- Manufactured to U.S. Fed. Spec. RR-C-271D Type VII, Class 2
- Forged steel - quenched and tempered
- Hot dip galvanized
- Swivel size permanently embossed
- Proof Load: 2 Times the Working Load Limit (WLL)
- Ultimate Load: 5 Times the Working Load Limit (WLL)

Size	Dimensions (inches)					WLL (lbs)	Vanguard Code
	A	B	C	D	E		
1/4	2.94	0.75	0.25	1.00	0.69	850	2929 0016
5/16	3.56	1.00	0.32	1.25	0.81	1,250	2929 0020
3/8	4.31	1.25	0.38	1.50	0.94	2,250	2929 0024
1/2	5.44	1.50	0.50	2.00	1.31	3,600	2929 0032
5/8	6.56	1.75	0.63	2.38	1.56	5,200	2929 0040
3/4	7.19	2.00	0.75	2.63	1.75	7,200	2929 0048
7/8	8.38	2.25	0.96	3.06	2.06	10,000	2929 0056
1	9.63	2.50	1.00	3.50	2.31	12,500	2929 0100
1-1/4	11.44	3.13	1.25	3.69	2.69	18,000	2929 0116
1-1/2	17.13	4.00	1.50	4.19	3.88	45,200	2929 0132

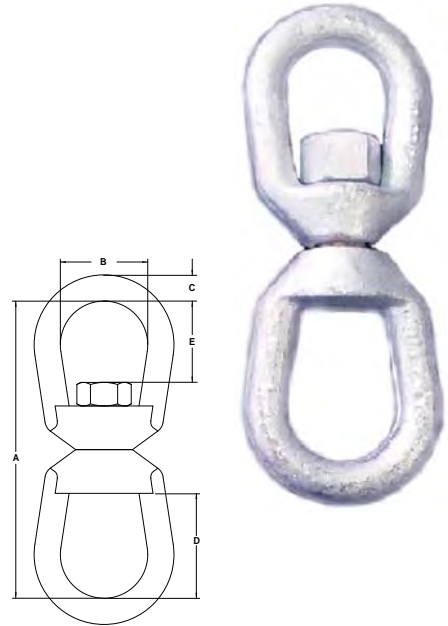

FORGED JAW & EYE SWIVELS

- Manufactured to U.S. Fed. Spec. RR-C-271D Type VII, Class 2
- Forged steel - quenched and tempered
- Hot dip galvanized
- Swivel size permanently embossed
- Proof Load: 2 Times the Working Load Limit (WLL)
- Ultimate Load: 5 Times the Working Load Limit (WLL)

Size	Dimensions (inches)							WLL (lbs)	Vanguard Code
	A	B	C	D	E	F	G		
1/4	2.63	0.75	0.47	0.88	0.69	1.25	0.25	850	2929 1016
5/16	2.94	1.00	0.50	0.88	0.81	1.63	0.31	1,250	2929 1020
3/8	3.63	1.25	0.63	1.06	0.94	2.00	0.38	2,250	2929 1024
1/2	4.50	1.50	0.75	1.31	1.31	2.50	0.50	3,600	2929 1032
5/8	5.31	1.75	0.94	1.50	1.56	3.00	0.63	5,200	2929 1040
3/4	5.06	2.00	1.13	1.75	1.75	3.50	0.75	7,200	2929 1048
7/8	7.00	2.25	1.19	2.06	2.06	4.00	0.88	10,000	2929 1056
1	8.56	2.50	1.75	2.81	2.31	4.50	1.13	12,500	2929 1100
1-1/4	9.75	3.13	2.06	2.81	2.69	5.69	1.38	18,000	2929 1116

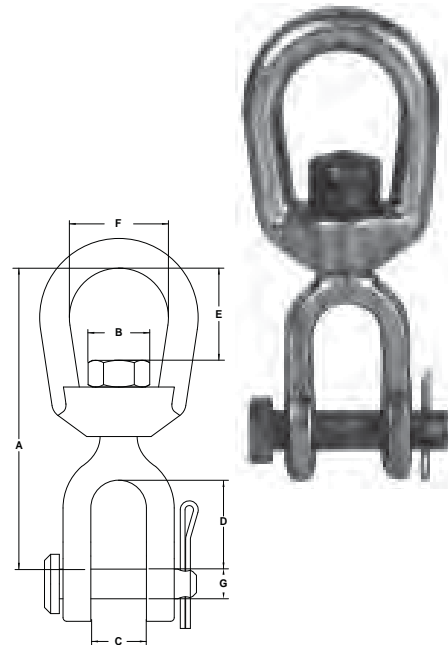

Warning:

NEVER EXCEED WORKING LOAD LIMITS!

- NEVER insert the point of a hook into a swivel eye
- These swivels are only for positioning and are not intended to act as swivels under load
- The working load limits (WLL) apply to straight line pulls only

WIRE ROPE HARDWARE

SWIVEL HOIST RINGS (METRIC THREADS)

- Embossed with VGDM trace code
- WLL and nominal size to meet ASME B 30.26

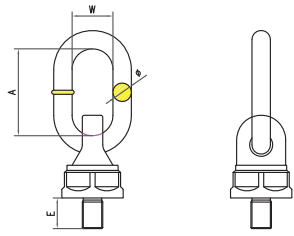

Tap Size	Dimensions (mm)				WLL at Lift Angle (tons)		Weight (lbs/pc)	Vanguard Code
	A	E	W	Ø	0 Deg.	90 Deg.		
M8	55	13	30	13	0.60	0.30	0.92	2978 20813
M8	55	18	30	13	0.60	0.30	0.95	2978 20818
M10	55	18	30	13	0.90	0.45	0.96	2978 21018
M10	55	25	30	13	0.90	0.45	1.11	2978 21025
M12	55	20	30	13	1.00	0.50	1.11	2978 21220
M12	55	27	30	13	1.00	0.50	1.11	2978 21227
M16	55	24	30	13	2.00	1.12	1.11	2978 21624
M16	55	30	30	13	2.00	1.12	1.12	2978 21630
M16	55	35	30	13	2.00	1.12	1.15	2978 21635
M20	85	30	40	18	4.00	2.00	2.14	2978 22030
M20	85	43	40	18	4.00	2.00	2.20	2978 22043
M24	85	30	40	18	6.30	3.15	3.22	2978 22430
M24	85	38	40	18	6.30	3.15	3.27	2978 22438
M30	115	35	50	25	10.60	5.30	4.81	2978 23035
M30	115	50	50	25	11.80	8.00	8.30	2978 23050
M36	115	54	50	25	11.80	8.00	8.65	2978 23654



SWIVEL HOIST RINGS (UNC THREADS)

- Embossed with VGD trace code
- WLL and nominal size to meet ASME B 30.26

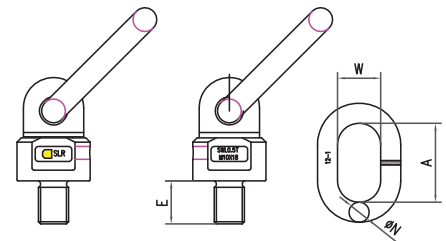

Tap Size	Dimensions (mm)				WLL at Lift Angle (lbs)		Weight (lbs/pc)	Vanguard Code
	A	E	W	NØ	0 Deg.	90 Deg.		
1/4" - 20	55	13	30	14	1,213	606	0.90	2978 11613
5/16" - 18	55	13	30	14	1,323	661	0.92	2978 12013
3/8" - 16	55	18	30	14	1,984	1,102	0.95	2978 12418
7/16" - 14	55	18	30	14	2,205	1,102	0.96	2978 12818
1/2" - 13	55	20	30	14	2,205	1,102	0.98	2978 13220
5/8" - 11	55	20	30	14	4,409	2,469	1.05	2978 14020
3/4" - 10	70	30	35	16	8,818	4,409	2.11	2978 14830
7/8" - 9	70	30	35	16	11,023	5,512	2.45	2978 15630
1" - 8	85	30	40	18	13,889	6,945	3.11	2978 16430
1-1/4" - 7	115	50	50	25	26,015	17,637	8.00	2978 18050



Warning:

NEVER EXCEED WORKING LOAD LIMITS!

- NEVER insert the point of a hook into a swivel eye
- These swivels are only for positioning and are not intended to act as swivels under load
- The working load limits (WLL) apply to straight line pulls only

EYE & EYE FORGED TURNBUCKLES WITH LOCKNUTS

- Meeting the requirements of U.S. Fed. Spec. FF-T-791B Type 1, Form 1 (open body)
- Permanently embossed with R, L, VGD© and size for traceability to meet ASME B30.26
- Hexagon heads forged into bodies permit fast and easy adjustments
- Forged carbon steel, bodies heat treated by normalizing, end-fitting quenched & tempered
- Hot dipped galvanized
- UNC Threads
- Design factor proof load 2.5:1, ultimate load 5:1

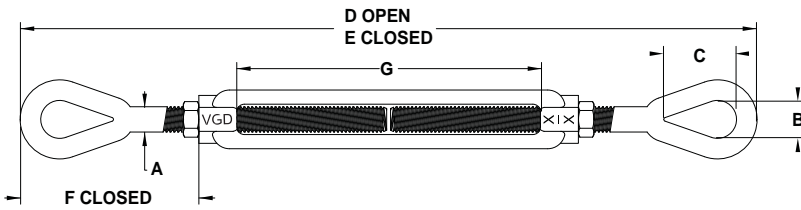

Diameter x Take-Up A x G	Dimensions (inches)					Approx. Weight (lbs)	WLL (lbs)	Vanguard Code
	B	C	D Open	E Closed	F Closed			
1/4 x 4	0.32	0.75	12.18	8.83	1.78	0.26	500	2920 10161
5/16 x 4-1/2	0.43	0.90	14.09	9.67	2.11	0.45	800	2920 10201
3/8 x 6	0.52	0.93	18.10	12.20	2.57	0.76	1,200	2920 10241
1/2 x 6	0.72	1.13	19.57	14.22	3.36	1.54	2,200	2920 10321
1/2 x 9	0.69	1.44	26.90	16.90	3.27	1.13	2,200	2920 20321
1/2 x 12	0.72	1.40	31.85	20.00	3.26	2.14	2,200	2920 30321
5/8 x 6	0.81	1.43	22.00	16.00	3.79	3.28	3,500	2920 10401
5/8 x 9	0.86	1.71	28.66	19.69	4.21	2.83	3,500	2920 20401
5/8 x 12	0.88	1.74	34.93	21.69	3.90	3.42	3,500	2920 30401
3/4 x 6	0.96	1.81	23.66	17.72	4.67	4.61	5,200	2920 10481
3/4 x 9	1.00	2.07	31.10	20.64	4.70	4.61	5,200	2920 20481
3/4 x 12	1.00	2.09	37.10	23.66	4.69	5.48	5,200	2920 30481
3/4 x 18	0.94	2.10	47.40	30.39	4.97	7.19	5,200	2920 40481
7/8 x 12	1.26	2.07	38.56	24.80	5.11	7.22	7,200	2920 30561
7/8 x 18	1.25	2.38	50.57	30.82	5.10	9.95	7,200	2920 40561
1 x 12	1.45	2.38	41.97	27.80	6.37	11.50	10,000	2920 31001
1 x 18	1.35	3.01	51.20	34.60	6.75	14.00	10,000	2920 41001
1 x 24	1.41	3.00	64.29	41.73	7.46	17.25	10,000	2920 51001
1-1/4 x 12	1.76	3.49	43.18	31.10	8.10	19.00	15,200	2920 31161
1-1/4 x 18	1.81	3.56	57.07	36.56	7.72	23.00	15,200	2920 41161
1-1/2 x 12	2.14	4.13	45.28	35.04	9.55	27.50	21,400	2920 31321
1-1/2 x 18	2.12	4.07	60.01	39.00	8.63	31.00	21,400	2920 41321
1-1/2 x 24	2.12	4.06	72.00	45.00	8.62	37.50	21,400	2920 51321
2 x 24	2.69	5.75	79.19	55.19	13.09	82.25	37,000	2920 52001

* Interchanged turnbuckles available upon request (sold in pairs)

Warning:

NEVER EXCEED WORKING LOAD LIMITS!
FAILURE TO OBSERVE these warnings may result in serious injury or death!

- Turnbuckles are designed for straight (in-line) pulls only
- **NEVER** re-use turnbuckles showing signs of deformation or damaged threads

WIRE ROPE HARDWARE

HOOK & HOOK FORGED TURNBUCKLES WITH LOCKNUTS

- Meeting the requirements of U.S. Fed. Spec. FF-T-791B Type 1, Form 1 (open body)
- Permanently embossed with R, L, VGD© and size for traceability to meet ASME B30.26
- Hexagon heads forged into bodies permit fast and easy adjustments
- Forged carbon steel, bodies heat treated by normalizing, end-fitting quenched & tempered
- Hot dipped galvanized
- UNC Threads
- Design factor proof load 2.5:1, ultimate load 5:1

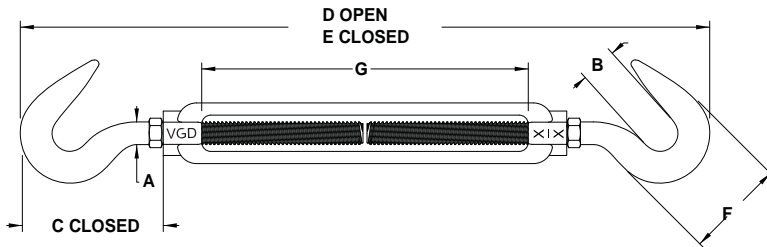

Diameter x Take-Up A x G	Dimensions (inches)					Approx. Weight (lbs)	WLL (lbs)	Vanguard Code
	B	C Closed	D Open	E Closed	F			
1/4 x 4	0.49	1.58	11.94	7.94	1.33	0.30	400	2923 10161
5/16 x 4-1/2	0.50	1.92	13.79	9.30	1.50	0.47	700	2923 10201
3/8 x 6	0.56	2.23	17.45	11.62	1.74	0.78	1,000	2923 10241
1/2 x 6	0.78	3.08	19.56	13.38	2.28	1.60	1,500	2923 10321
1/2 x 9	0.71	3.23	24.61	16.93	3.19	1.83	1,500	2923 20321
1/2 x 12	0.77	3.25	31.50	19.38	2.24	2.28	1,500	2923 30321
5/8 x 6	0.91	3.69	22.51	15.25	2.81	2.75	2,250	2923 10401
5/8 x 9	0.85	3.93	27.00	18.50	2.71	3.38	2,250	2923 20401
5/8 x 12	0.84	3.47	32.80	21.18	2.70	3.50	2,250	2923 30401
3/4 x 6	0.99	4.52	24.78	17.29	3.33	3.89	3,000	2923 10481
3/4 x 9	0.99	4.36	30.87	20.28	3.33	5.28	3,000	2923 20481
3/4 x 12	1.01	4.36	34.75	23.25	3.15	5.43	3,000	2923 30481
3/4 x 18	0.98	4.52	48.79	28.28	3.33	8.12	3,000	2923 40481
7/8 x 12	1.13	5.19	38.76	25.00	3.79	8.10	4,000	2923 30561
7/8 x 18	1.13	5.19	50.85	31.00	3.78	9.95	4,000	2923 40561
1 x 12	1.27	6.12	38.20	26.77	3.99	11.93	5,000	2923 31001
1 x 18	1.25	5.85	52.36	32.69	4.25	14.00	5,000	2923 41001
1 x 24	1.25	5.87	64.69	38.70	4.26	17.25	5,000	2923 51001
1-1/4 x 12	1.51	7.22	44.06	29.58	5.13	20.58	6,500	2923 31161
1-1/4 x 18	1.51	7.22	56.07	35.56	5.15	23.00	6,500	2923 41161
1-1/2 x 12	1.88	8.36	47.45	32.44	5.75	27.50	7,500	2923 31321
1-1/2 x 18	1.89	8.35	59.45	38.45	5.75	31.00	7,500	2923 41321
1-1/2 x 24	1.90	8.38	71.45	44.45	5.75	37.50	7,500	2923 51321

* Interchanged turnbuckles available upon request (sold in pairs)

Warning:

NEVER EXCEED WORKING LOAD LIMITS!

FAILURE TO OBSERVE these warnings may result in serious injury or death!

- Turnbuckles are designed for straight (in-line) pulls only
- **NEVER** re-use turnbuckles showing signs of deformation or damaged threads

JAW & JAW FORGED TURNBUCKLES WITH LOCKNUTS

- Meeting the requirements of U.S. Fed. Spec. FF-T-791B Type 1, Form 1 (open body)
- Permanently embossed with R, L, VGD© and size for traceability to meet ASME B30.26
- Hexagon heads forged into bodies permit fast and easy adjustments
- Forged carbon steel, bodies heat treated by normalizing, end-fitting quenched & tempered
- Hot dipped galvanized
- UNC Threads
- Design factor proof load 2.5:1, ultimate load 5:1

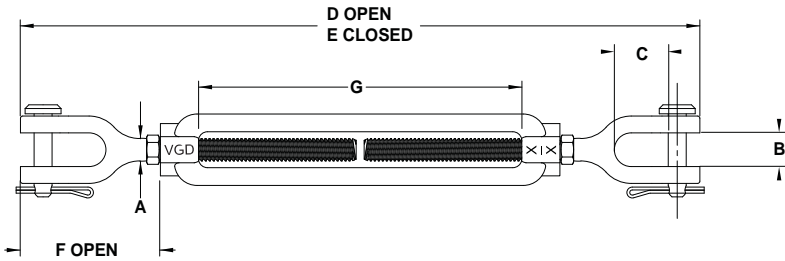

Diameter x Take-Up A x G	Dimensions (inches)					Approx. Weight (lbs)	WLL (lbs)	Vanguard Code
	B	C	D Open	E Closed	F Open			
1/4 x 4	0.54	0.68	12.01	7.89	1.79	0.36	500	2925 10161
5/16 x 4-1/2	0.59	0.91	13.92	9.41	2.13	0.52	800	2925 10201
3/8 x 6	0.74	1.04	17.63	11.38	2.52	0.81	1,200	2925 10241
1/2 x 6	0.65	1.08	19.09	13.19	2.71	1.56	2,200	2925 10321
1/2 x 9	0.61	1.10	23.95	15.95	2.65	1.74	2,200	2925 20321
1/2 x 12	0.66	1.07	30.90	19.00	2.72	2.40	2,200	2925 30321
5/8 x 6	0.77	1.46	22.13	14.89	3.43	2.72	3,500	2925 10401
5/8 x 9	0.95	1.46	27.20	18.31	3.70	3.43	3,500	2925 20401
5/8 x 12	0.77	1.42	32.99	21.26	3.70	3.91	3,500	2925 30401
3/4 x 6	1.05	1.61	22.75	16.75	4.23	4.11	5,200	2925 10481
3/4 x 9	1.01	1.76	28.50	19.50	4.19	5.46	5,200	2925 20481
3/4 x 12	1.02	1.75	34.75	22.75	4.29	6.43	5,200	2925 30481
3/4 x 18	0.90	1.61	49.29	29.53	4.56	8.07	5,200	2925 40481
7/8 x 12	1.24	2.01	36.25	24.62	5.00	8.14	7,200	2925 30561
7/8 x 18	1.23	1.75	50.17	30.30	4.86	10.78	7,200	2925 40561
1 x 6	1.26	2.14	30.43	20.50	5.74	10.18	10,000	2925 11001
1 x 12	1.40	2.19	38.00	26.50	5.84	12.52	10,000	2925 31001
1 x 18	1.21	2.07	51.00	33.00	6.01	15.14	10,000	2925 41001
1 x 24	1.31	2.07	64.06	38.06	5.53	18.08	10,000	2925 51001
1-1/4 x 12	2.03	2.94	41.75	30.50	7.50	20.59	15,200	2925 31161
1-1/4 x 18	2.08	2.95	54.00	37.50	8.25	24.68	15,200	2925 41161
1-1/2 x 12	2.19	2.93	43.62	32.68	7.97	30.69	21,400	2925 31321
1-1/2 x 18	2.08	2.80	56.30	38.58	8.38	36.75	21,400	2925 41321
1-1/2 x 24	2.34	3.10	69.00	45.00	8.88	40.67	21,400	2925 51321
2 x 24	3.07	4.14	76.38	54.13	12.40	94.25	37,000	2925 52001

* Interchanged turnbuckles available upon request (sold in pairs)

Warning:

NEVER EXCEED WORKING LOAD LIMITS!

FAILURE TO OBSERVE these warnings may result in serious injury or death!

- Turnbuckles are designed for straight (in-line) pulls only
- **NEVER** re-use turnbuckles showing signs of deformation or damaged threads

WIRE ROPE HARDWARE

FORGED TURNBUCKLE BODIES

- Meet the requirements of US Fed. Spec. FF-T-791B Type 1, Form 1 (open body)
- Permanent embossed with R, L, VGD® and size for traceability to meet ASME B30.26
- Forged carbon steel, heat treated by normalizing
- Hot dipped galvanized
- UNC Threads
- Design factor proof load 2.5:1 the WLL - ultimate load 5:1 the WLL

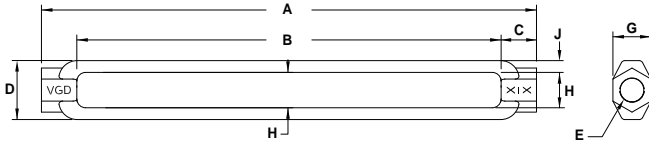

Diameter x Take-Up E x B	Dimensions (inches)						Approx. Weight (lbs)	WLL (lbs)	Vanguard Code
	A	C	D	G	H	J			
3/8 x 6	7.13	0.56	0.88	0.62	0.50	0.19	0.29	1,200	2927 1024C
1/2 x 6	7.51	0.75	1.12	0.81	0.62	0.25	0.60	2,200	2927 1032C
5/8 x 6	7.88	0.94	1.38	1.00	0.75	0.31	0.90	3,500	2927 1040C
3/4 x 6	8.18	1.08	1.63	1.12	0.94	0.38	1.30	5,200	2927 1048C
7/8 x 6	8.62	1.31	1.94	1.31	1.06	0.44	1.80	7,200	2927 1056C
1 x 6	9.00	1.50	2.25	1.50	1.25	0.50	2.48	10,000	2927 1100C
1-1/4 x 6	9.12	1.56	2.62	1.88	1.50	0.56	3.75	15,200	2927 1116C
1-1/2 x 6	9.78	1.88	3.00	2.25	1.75	0.62	6.50	21,400	2927 1032C

FORGED STUB END TURNBUCKLES

- Meet the requirements of US Fed. Spec. FF-T-791B Type 1, Form 1 (open body)
- Permanent embossed with R, L, VGD® and size for traceability to meet ASME B30.26
- Forged carbon steel bodies heat treated by normalizing. end fittings quenched and tempered
- Self colored
- UNC Threads
- Design factor proof load 2.5:1 the WLL - ultimate load 5:1 the WLL

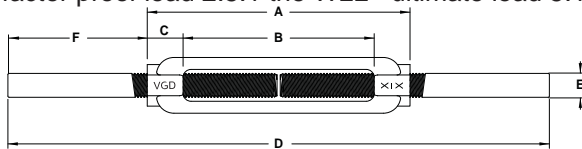

Diameter x Take-Up E x B	Dimensions (inches)				Approx. Weight (lbs)	WLL (lbs)	Vanguard Code
	A	C	D	F			
3/8 x 6	7.13	0.56	16.00	4.45	0.76	1,200	2926 1024C
1/2 x 6	7.50	0.75	16.00	4.25	1.54	2,200	2926 1032C
5/8 x 6	7.88	0.94	16.00	4.07	3.28	3,500	2926 1040C
3/4 x 6	8.25	1.13	17.00	4.38	3.79	5,200	2926 1048C
7/8 x 6	8.63	1.31	18.00	4.69	5.84	7,200	2926 1056C
1 x 6	9.01	1.51	19.00	5.01	9.04	10,000	2926 1100C

Warning:

NEVER EXCEED WORKING LOAD LIMITS!

FAILURE TO OBSERVE these warnings may result in serious injury or death!

- Turnbuckles are designed for straight (in-line) pulls only
- **NEVER** re-use turnbuckles showing signs of deformation or damaged threads

WELDLESS PEAR SHAPED LINKS

- Drop Forged - Alloy Steel – Quenched and Tempered
- Hot dipped galvanized finish
- Permanently embossed with Vanguard, size, Working Load Limit (WLL) and trace code
- Proof Load 2 times WLL
- Design factor 5 times WLL

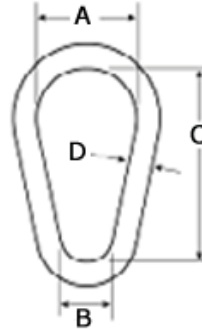

Dimensions (inches)				WLL* (lbs)	Weight (lbs)	Vanguard Code
D	A	B	C			
3/8	1.50	0.75	2.25	1,800	0.23	3932 1024
1/2	2.00	1.00	3.00	7,000	0.55	3932 1032
5/8	2.50	1.25	3.75	9,000	1.10	3932 1040
3/4	2.75	1.38	4.50	12,300	1.95	3932 1048
7/8	3.50	1.75	5.25	15,000	2.78	3932 1056
1	3.75	1.88	6.00	24,360	4.30	3932 1100

Note:

Working Load Limit (WLL) is based upon single leg (in-line load), or resultant load on multiple legs with an included angle less than or equal to 120°

Warning:

NEVER EXCEED WORKING LOAD LIMIT!

Failure to follow instructions can result in serious property damage, injury or death!

- Proof loading is mandatory for weldless pear shaped links when used on any overhead lifting apparatus

WIRE ROPE SHEAVES

- Machined from C-1045 steel

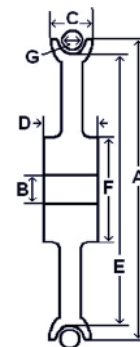

Dimensions (inches)							Weight (lbs)	Vanguard Code
A	B	C	D	E	F	G		
3	3/4	7/8	1	2-1/4	1-1/4	5/16	1	2937 0300
4	1	7/8	1	3-1/8	1-1/2	3/8	2	2937 0400
5	1	7/8	1	4	2-1/2	1/2	3	2937 0500
6	1-3/8	1-1/4	1-1/2	4-3/4	3	5/8	6	2937 0600

- Alternate bore sizes can be achieved by installing self-lubricated Bronze bushings!
- There is no established load rating for these sheaves; the Working Load Limit (WLL) depends on the pulleys onto which the sheaves are to be installed!

Warning:

NEVER EXCEED WORKING LOAD LIMITS!

SNATCH BLOCK WARNINGS AND INFORMATION

It is very important to read and understand all information shown before using a snatch block



V-1800 (with Hook)



V-1900 (with Swivel Shackle)



V-4000 (Tail Board - Pin Only)



WARNING

FAILURE TO OBSERVE THESE WARNINGS MAY RESULT IN SERIOUS INJURY OR DEATH!

All inspections, maintenance, block lifting design and rigging of blocks should be performed by a qualified/competent person (as defined by ANSI/ASME B.30)

- **ALWAYS** inspect snatch blocks before use (see maintenance section below). If during the inspection the unit is found to be damaged, cracked or deformed it must be removed from service immediately for repair.
- **ALWAYS** design and rig snatch block systems so that the load will not slip or fall.
- **ALWAYS** design lifting systems with the appropriate number of sheave assemblies to prevent premature sheave, bearing or wire rope wear and failure.
- **ALWAYS** make sure that all workers keep their hands, bodies and clothing away from the block sheaves, and pinch points where the wire rope makes contact with any part of the block or load.
- **ALWAYS** make sure that the hook NOT that latch supports the load.
- **ALWAYS** make sure that snatch blocks are regularly inspected, lubricated and maintained (see maintenance section shown below).
- **NEVER** exceed the working load limit (WLL).
- **NEVER** side load a snatch block.
- **NEVER** weld snatch blocks or load supporting parts.
- **NEVER** lift or transport loads over or near people.

MAINTENANCE:

To ensure peak efficiency and extended service life, it is necessary that blocks be inspected at frequent intervals. The inspection should be performed by a properly trained/competent person (as defined by ANSI/ASME B.30)

Inspect the block for any signs of wear or damage such as:

- Worn or damaged sheaves, bushings, side plates, pins, hooks or shackles. Damaged snatch blocks must be immediately removed from service until repaired. Replace any part showing signs of wear or damage!
- Hook latch for proper fit and operation. Replace deformed latches!

LOADS:

Throughout this catalogue the term Working Load Limit (WLL) is being used. It refers to the maximum load or force which a product is designed to support under normal operating and environmental conditions, the product is considered to be in an 'as new' condition.

IMPORTANT:

The total load on a block, and therefore also on any fitting which is attached to the block, is usually considerably greater than the actual load lifted or pulled. The deciding factor in determining the total load on a single line block is the angle between the lead line and load line.

SNATCH BLOCKS

- Forged alloy hooks – heat treated – with latch
- Shackle forged steel – heat treated
- Forged steel swivel tees, yokes and shafts
- Bronze bush with grease nipple
- Fittings are painted yellow for quick recognition
- Designed for intermittent use with low line speed
- Ultimate load 4 x Working Load Limit (WLL)

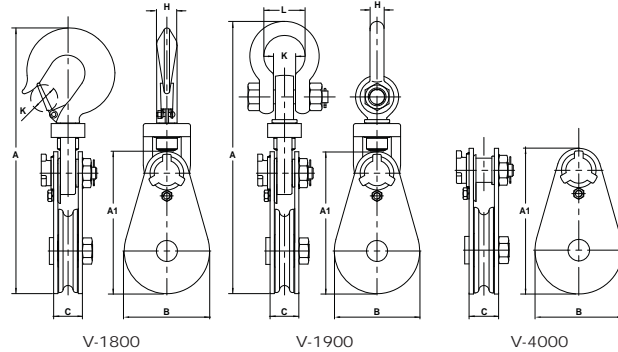

Dimensions (inches)							Sheave Diameter (inches)	Rope Diameter (inches)	WLL (tons)	Weight (lbs/pc)	Vanguard Code
A	A1	B	C	H	K	L					
V-1800 SNATCH BLOCK WITH HOOK AND LATCH											
9.65	4.88	2.99	1.50	0.79	0.91		3	3/8	2	3	2936 2030
14.09	7.46	4.25	1.99	1.18	1.50		4-1/2	1/2	4	12	2936 2045
17.91	9.65	5.98	2.30	1.42	1.81		6	3/4	8	27	2936 2060
19.88	11.78	7.99	2.30	1.42	1.81		8	3/4	8	35	2936 2080
21.89	13.90	10.00	2.30	1.42	1.81		10	3/4	8	50	2936 2100
24.72	13.29	7.99	2.72	1.69	2.09		8	1-1/8	15	58	2936 2081
28.15	14.80	7.99	3.35	2.28	2.60		8	1-1/8	20	103	2936 2082
V-1900 SNATCH BLOCK WITH SWIVEL SHACKLE											
9.65	4.88	2.99	1.50	0.79	1.28	0.50	3	3/8	2	3	2935 3030
13.94	7.46	4.25	1.99	1.22	1.91	0.75	4-1/2	1/2	4	13	2935 3045
18.31	9.65	5.98	2.30	1.69	2.68	1.00	6	3/4	8	29	2935 3060
20.28	11.75	7.99	2.30	1.69	2.68	1.00	8	3/4	8	36	2935 3080
22.24	13.90	10.00	2.30	1.69	2.68	1.00	10	3/4	8	53	2935 3100
29.06	20.83	14.25	2.30	1.69	2.68	1.00	14	5/8	8	81	2935 3140
24.88	13.29	7.99	2.72	2.09	3.46	1.44	8	1-1/8	15	65	2935 3081
27.52	15.87	10.08	2.72	2.09	3.46	1.44	10	7/8 - 1	15	82	2935 3101
29.09	14.80	7.99	3.35	2.36	3.80	1.54	8	1-1/8	20	117	2935 3082
V-4000 TAILBOARD WITH PIN ONLY											
	4.88	2.99	1.50				3	3/8	2	3	2935 1030
	7.46	4.25	1.99				4-1/2	1/2	4	8	2935 1045
	9.65	5.98	2.30				6	3/4	8	15	2935 1060
	11.75	7.99	2.30				8	3/4	8	25	2935 1080
	13.29	7.99	2.72				8	1-1/8	15	35	2935 1081
	14.80	7.99	3.35				8	1-1/8	20	70	2935 1083

LOAD CALCULATION TABLE

Lead/Load Line Angle	Factor	Lead/Load Line Angle	Factor	Lead/Load Line Angle	Factor
0°	2.00	60°	1.73	130°	0.84
10°	1.99	70°	1.64	135°	0.76
20°	1.97	80°	1.53	140°	0.68
30°	1.93	90°	1.41	150°	0.52
40°	1.87	100°	1.29	160°	0.35
45°	1.84	110°	1.15	170°	0.17
50°	1.81	120°	1.00	180°	0.00

$$\frac{\text{Actual Load Lifted} \times \text{Multiplication Factor}}{\text{Total Load on Block (single line systems only)}}$$

Warning:

NEVER EXCEED WORKING LOAD LIMITS!

Failure to follow these instructions can result in serious property damage, injury or death!

- Please see snatch block warning and information section for greater detail

WIRE ROPE HARDWARE

YARDING BLOCKS

- Designed for light duty high speed applications
- Forged steel shackle
- Roller bearings with grease nipple
- Pull pin to use as snatch block
- Top eye swivels opens for easy access to sheave
- Sheave axle secured with lock washer and nut to help prevent loosening due to vibration
- Ultimate load 3 x Working Load Limit (WLL)

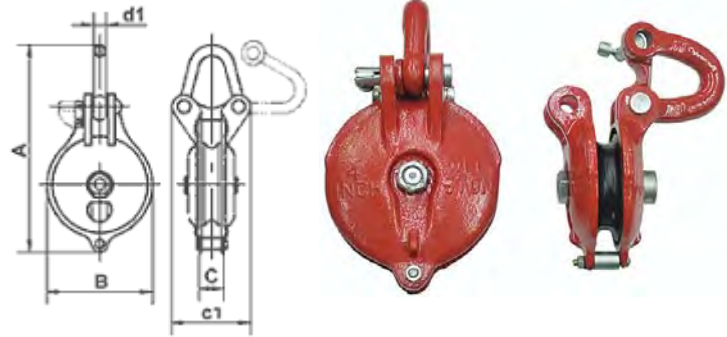

WLL (tons)	Dimensions (inches)						Weight (lbs/pc)	Vanguard Code	
	Sheave Diameter	A	B	C	C-1	D-1		Painted (Red)	Hot Dipped Galvanized
1-1/2	3	6.93	3.35	1.02	3.15	0.47	3	2936 0300	2936 03001
3	4	9.25	4.76	1.34	3.39	0.63	5	2936 0400	2936 04001
4-1/2	5	12.01	5.71	1.50	4.06	0.71	9	2936 0500	2936 05001
6	6	13.78	7.09	1.61	4.33	0.87	17	2936 0600	2936 06001
8	8	16.73	8.86	1.81	6.50	1.10	35	2936 0800	2936 08001

* H.D. Galv units are not a standard stock item at all distribution centres.

FX YARDING BLOCKS

- Designed for light duty high speed applications
- Forged steel shackle
- Roller bearings with grease nipple
- Pull pin to use as snatch block
- Top eye swivels opens for easy access to sheave
- Sheave axle secured with lock washer and nut to help prevent loosening due to vibration
- All black finish helps the block to blend into its surroundings
- Ultimate load 3 x Working Load Limit (WLL)

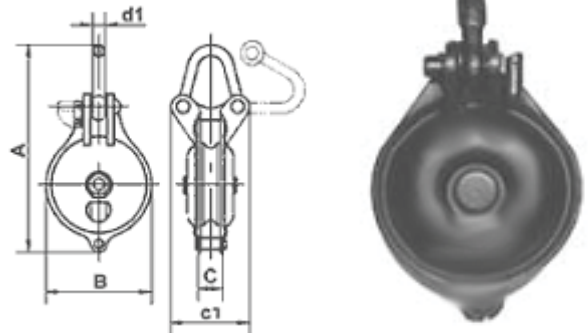

WLL (tons)	Dimensions (inches)						Weight (lbs/pc)	Vanguard Code
	Sheave Diameter	A	B	C	C-1	D-1		
1-1/2	3	6.93	3.35	1.02	3.15	0.47	3	2936 0030
3	4	9.25	4.76	1.34	3.39	0.63	5	2936 0040

* FX Yarding Blocks are not a standard stock item at all distribution centres.

Warning:

NEVER EXCEED WORKING LOAD LIMITS!

Failure to follow these instructions can result in serious property damage, injury or death!

GIN BLOCKS

- Designed for light hoisting with low line speed
- Forged swivel hook with latch
- Painted red finish
- For use with manila and/or 3 strand synthetic ropes
- Commonly used by roofers, painters and industrial contractors
- Ultimate load 3 x Working Load Limit (WLL)

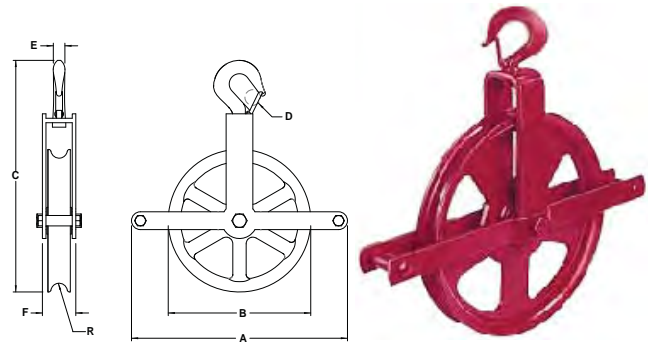

Dimensions (inches)							Rope Size (inches)	WLL (tons)	Weight (lbs/pc)	Vanguard Cod
A	B	C	D	E	F	R				
14.95	11.97	17.80	0.91	0.78	2.09	0.53	1	1	13	2935 4012

PULLEY BLOCKS (Single Sheave)

- Cast iron sheaves
- Bronze bushing and C1045 steel supporting bushing provide better oil retention
- Hook complete with latch
- Side plate opens for easy access to sheave
- Zerk type grease fittings
- Tested to 200% of the rated capacity

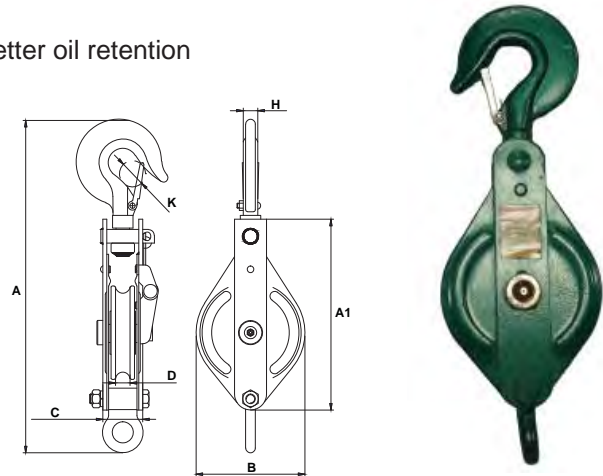

Dimensions (inches)						Sheave Size (inches)	Rope Size (inches)	WLL (tons)	Weight (lbs/pc)	Vanguard Code
A	A1	B	C	H	K					
11.73	6.73	3.46	1.38	0.57	0.79	3	3/8	1/2	3.15	2935 5030
13.74	7.98	4.41	1.61	0.59	0.87	4	7/16	1	5.54	2935 5040
15.91	9.43	5.51	1.77	0.79	0.91	5	1/2	1-1/2	8.30	2935 5050
18.98	10.83	6.46	2.05	1.10	1.30	6	5/8	2	15.50	2935 5060

* Not a standard stock item at all distribution centres.

** Additional sizes and multiple sheave units available upon request, minimum order quantities may apply

Warning:

NEVER EXCEED WORKING LOAD LIMITS!

Failure to follow these instructions can result in serious property damage, injury or death!

WIRE ROPE HARDWARE

SK 05 KOREAN TYPE BLOCKS

- Used for lashing equipment on lumber vessels and log carriers
- Forged alloy swivel eye, heat treated
- Top eye swivel opens for easy access to sheave
- Bearing
- Painted Red finish
- Ultimate load 2 x Working Load Limit (WLL)



Sheave Diameter (inches)	Rope Size (inches)	WLL (tons)	Weight (lbs/pc)	Vanguard Code
6	3/4 - 15/16	5	35.30	2935 6060

* Not a standard stock item at all distribution centres.

ROLLER SHACKLE

- Used for lashing equipment on lumber vessels and log carriers
- Hot dipped galvanized
- Ultimate load 2 x Working Load Limit (WLL)

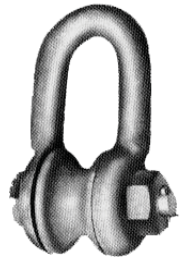

Dimensions (inches)			Rope Size (inches)	WLL (tons)	Weight (lbs/pc)	Vanguard Code
Sheave Diameter	Roller Thickness	Roller Diameter				
1-1/8	2	2 - 7/8	4	4	8.20	2946 6028

* Not a standard stock item at all distribution centres.

Warning:

NEVER EXCEED WORKING LOAD LIMITS!

Failure to follow these instructions can result in serious property damage, injury or death!

IMPACT CUTTERS

- Portable cutters strictly designed for cutting wire ropes
- Actuated by striking with a hammer, they are easy to operate and give superior performance without jamming
- Precision-engineered to deliver a clean cut without affecting the original roundness of the wire rope
- Blades and dies made of high quality tool steel, heat treated and ground to close tolerances
- Replacement parts available upon request



Model No.	Maximum Rope Diameter (inches)	Dimensions (inches)		Weight (lbs/pc)	Vanguard Code
		Height	Base		
1 - Light Duty	3/4	6	3-1/2	8	3001 5000
1A - Heavy Duty	11/16	7	6-1/4	17	3001 5001
2 - Extra Heavy Duty	1-1/2	9	7-3/4	28	3001 6000

REPLACEMENT PARTS FOR IMPACT CUTTERS

Item	Model No.	Vanguard Code
Plunger & Pin	1 - Light Duty	3002 5000
	1A - Heavy Duty	3002 5010
	2 - Extra Heavy Duty	3002 6000
Die Sets	1 - Light Duty	3002 5001
	1A - Heavy Duty	3002 5011
	2 - Extra Heavy Duty	3002 6001
Blade & Pin	1 - Light Duty	3002 5002
	1A - Heavy Duty	3002 5012
	2 - Extra Heavy Duty	3002 6002
Blade Pins	1 - Light Duty	3002 5003
	1A - Heavy Duty	3002 5013
	2 - Extra Heavy Duty	3002 6003

Warning:

Failure to follow these instructions can result in serious property damage, injury or death!

- Cutters are sharp and should be used with extreme caution!
- Cutters may be damaged if used beyond the stated capacity or on materials/products that they are not designed to cut



FELCO C-3 CUTTER

- Thumb catch designed for one hand use
- Hardened and tempered blades
- Triangular cutting actions of the blades avoids squashing of strands. Thanks to this feature it is typically not necessary to tie the cable before cutting.
- Designed for repetitive use
- Ideal for smaller diameters thanks to the specially shaped cutting head
- The supple spring reduces user fatigue and increase comfort



FELCO C-7 CUTTER

- Thumb catch designed for one hand use
- Triangular cutting actions of the blades avoids squashing of strands. Thanks to this feature it is typically not necessary to tie the cable before cutting.
- Designed for repetitive use
- Blade and centre bolt are made of high quality hardened steel offering exceptional performance
- Pressed steel handles with non-slip grips



FELCO CDO – COMMANDO

For cutting barbed wire

- The cutting notch allows the wire to be caught by holding it at the bottom of the cutting profile, designed for one hand use
- Hardened and tempered blades designed to cut the strongest cables
- Triangular cutting actions of the blades avoids squashing of strands. Thanks to this feature it is typically not necessary to tie the cable before cutting.
- Well suited for fishery, forestry and agricultural applications



FELCO CP

Universal cutter

- Thumb catch designed for one hand use
- Hardened and tempered blades
- Extremely versatile tool, offering very clean cutting on a wide variety of materials
- Well suited for cutting wire mesh, netting, sheet metal, leather, plastic, paper, packing straps and wire



FELCO C-9 CUTTER



- Strong, lightweight forged aluminum handles
- Plastic handle grips provide comfort when in use
- Blades and fasteners are made of high quality hardened steel
- Triangular cutting actions of the blades avoids squashing of strands. Thanks to this feature it is typically not necessary to tie the cable before cutting.
- Capable of cutting materials up to 0.35" (9mm)

FELCO C-12 CUTTER

- Strong, lightweight forged aluminum handles
- Plastic handle grips provide comfort when in use
- Blades and fasteners are made of high quality hardened steel
- Triangular cutting actions of the blades avoids squashing of strands. Thanks to this feature it is typically not necessary to tie the cable before cutting.
- Capable of cutting materials up to 0.47" (12mm)



FELCO C-16 CUTTER



- Strong, lightweight forged aluminum handles
- Plastic handle grips provide comfort when in use
- Blades and fasteners are made of high quality hardened steel
- Triangular cutting actions of the blades avoids squashing of strands. Thanks to this feature it is typically not necessary to tie the cable before cutting.
- Capable of cutting materials up to 0.63" (16mm)

**** If you are cutting electrical cable primarily the C-16E cutter is your best choice**

FELCO C-108 CUTTER

- Strong, lightweight forged aluminum handles
- Plastic handle grips provide comfort when in use
- Blades and fasteners are made of high quality hardened steel, they are phosphate treated making them extremely corrosions resistant.
- Triangular cutting actions of the blades avoids squashing of strands. Thanks to this feature it is typically not necessary to tie the cable before cutting.
- Unique reduction gearing system, provides the maximum amount of force transmission by intensifying the users' energy.
- Capable of cutting materials up to 0.32" (8mm)



FELCO C-112 CUTTER



- Strong, lightweight forged aluminum handles
- Plastic handle grips provide comfort when in use
- Blades and fasteners are made of high quality hardened steel, they are phosphate treated making them extremely corrosions resistant
- Triangular cutting actions of the blades avoids squashing of strands. Thanks to this feature it is typically not necessary to tie the cable before cutting
- Unique reduction gearing system, provides the maximum amount of force transmission by intensifying the users' energy
- Capable of cutting materials up to 0.50" (12.7mm)

WIRE ROPE HARDWARE

STANDARD SPARE PARTS LISTING

Model No.	Part No.	Description	Vanguard Code
C-7	C 7/4	Bolt	3002 0407
	C 7/5	Counter Nut	3002 0907
	C 7/10	Spring	3002 1907
C-9	C 9/2	Handle with Plastic Pin	3002 0209
	C 9/3	Plastic Handle Grip	3002 0309
	C 9/4	Pin	3002 0409
	C 9/5	Blade (Single)	3002 0509
	C 9/90	Parts Kit (includes C9/6, C9/7 & C9/8)	3002 3099
C-12	C 12/2	Handle with Plastic Pin	3002 0212
	C 12/3	Plastic Handle Grip	3002 0312
	C 12/4	Pin	3002 0412
	C 12/5	Blade (Single)	3002 0512
	C 12/90	Parts Kit (includes C12/6, C12/7, C12/8 & C12/9)	3002 3129
C-16	C 16/2	Handle with Plastic Pin	3002 0216
	C 16/3	Plastic Handle Grip	3002 0316
	C 16/4	Pin	3002 0416
	C 16/5	Blade (Single)	3002 0516
	C 16/90	Parts Kit (includes C16/6, C16/7, C16/8 & C16/9)	3002 3169
C-108	C 108/2	Handle with Plastic Pin	3002 0218
	C 108/5	Blade (Single)	3002 0518
	C 108/6	Centre Bolt	3002 0618
	C 108/10	Hex Screw	3002 1018
	C 108/11	Counter Nut	3002 1118
	C 108/12	Cam	3002 1218
	C 108/13	Finger	3002 1318
	C 108/14	Lever with 2 Pins	3002 1418
	C 108/15	Pin for Cam	3002 1518
C 108/16	Pin for Finger	3002 1618	
C-112	C 112/2	Handle with Coating and Pin	3002 0220
	C 112/5	Blade (Single)	3002 0520
	C 112/6	Centre Bolt	3002 0620
	C 112/10	Hex Screw	3002 1020
	C 112/12	Cam	3002 1220
	C 112/13	Finger	3002 1320
	C 112/14	Lever with 2 Pins	3002 1420
	C 112/16	Pin for Finger and Cam	3002 1620
	C 112/17	Mobile Spare Blade	3002 1720
	C 112/18	Connecting Rod	3002 1820
	C 112/19	Bolt for Lever	3002 1920
	C 112/20	Washer	3002 2020
	C 112/21	Nut	3002 2120
C 112/22	Counter Nut	3002 2220	

Warning:

- These tools are sharp and should be used with caution!
- These cutters if used beyond the stated capacities or on materials not indicated on application chart can damage the blades and parts
- After use tools should be properly cleaned, it is also recommended that oil be applied to the blades and bolts to prevent corrosion



WIRE ROPE HARDWARE



Application Suitability	Model and Maximum Capabilities (inches)			
	C-3	C-7	CDO	CP
Galvanized steel cables, fiber core	0.12	0.28	0.20	0.08
Galvanized steel cable, steel core	0.10	0.20		
Welded wire mesh		✓		✓
Hard steel cables, resistance 160 kg/mm ²		0.20		
Non-oxidable cable 190 kg/mm ²		0.16		
Extremely tough steel cables, resistance 210 kg/mm ²		0.12		
Electrical cable (copper or aluminum) with steel core	0.12	0.28		
Aluminum or copper rod	0.12	0.20		
Iron rod, resistant to 60 kg/mm ²		0.16		
Tempered spring wire		0.10		
Steel strip 0.06 x 1.26" (1.5 x 32mm)				0.06
Rubber conveyor belts		✓		
Leather sheet				✓
Barbed wire			✓	

Application Suitability	Model and Maximum Capabilities (inches)					
	C-9	C-12	C-16	C-16E Electrical	C-108	C-112
Galvanized steel cables, fiber core	0.35	0.47	0.63	0.63	0.32	0.50
Galvanized steel cable, steel core	0.32	0.40	0.55	0.55	0.32	0.50
Welded wire mesh	✓	✓	✓		✓	✓
Hard steel cables, resistance 160 kg/mm ²	0.28	0.32	0.55	0.39	0.32	0.50
Non-oxidable cable 190 kg/mm ²	0.24	0.24	0.28		0.32	0.50
Extremely tough steel cables, resistance 210 kg/mm ²	0.20	0.20	0.24		0.32	0.50
Electrical cable (copper or aluminum) with steel core	0.35	0.47	0.63	0.79	0.32	0.50
Aluminum or copper rod	0.35	0.39	0.55	0.55	0.32	0.50
Iron rod, resistant to 60 kg/mm ²	0.28	0.32	0.39	0.39	0.32	0.50
Tempered spring wire	0.12	0.16	0.20	0.20	0.24	0.32
Rubber conveyor belts	✓	✓	✓			
Pre-stressed concrete girder			✓		✓	✓

Model	Overall Length (inches)	Weight (lbs/pc)	Vanguard Code
C-3	7.50	0.60	3001 0003
C-7	8.00	0.63	3001 0007
CDO	7.70	0.62	3001 0005
CP	8.10	0.64	3001 0006
C-9	12.80	1.65	3001 0009
C-12	19.70	3.31	3001 0012
C-16	23.20	5.07	3001 0016
C-16E	23.20	5.07	3001 0017
C-108	22.00	4.30	3001 0108
C-112	28.70	7.94	3001 0112

SWAGING TOOLS

Are designed to crimp ovals and stop sleeves. When properly swaged oval sleeves will offer the same published nominal breaking strength of the cable it is being used on (designed for use on 3 x 7; 7 x 7; and 7 x 19 constructions). Sleeves used on other constructions will not hold to the nominal published breaking strength.



Hand Swager



Bench Swager



Combo Swager

Model No.	Applications	Length (inches)	Weight (lbs/pc)	Vanguard Code
HAND SWAGER				
0 - 3/64	Swages 3/64" oval and stop sleeves, plus 3/64" and 1/16" stainless steel oval sleeves.	20.00	4.20	3003 0013
0 - 1/16SC	Swages 1/16" oval and stop sleeves, plus 3/32" stainless steel oval sleeves.	20.00	4.20	3003 1004
HSC 350	Swages 1/16, 5/64, 3/32, 7/64 and 1/8" oval and stop sleeves. Cutting feature included in jaw	16.93	2.42	3003 1006
HSC 600	Swages 1/16, 5/64, 3/32, 7/64. 1/8, 5/32 and 3/16" oval and stop sleeves. Cutting feature included in jaw.	25.60	5.51	3003 1002
0 - 3/16SC	Swages 3/16" oval sleeves, plus 7/32" stainless steel sleeves.	20.00	4.20	3003 0004
0 - 1/4	Designed for swaging copper and aluminum 1/4" oval sleeve and 1/4, 5/16 and 3/8" stop sleeve.	28.00	5.00	3003 0003
0 - 5/16	Designed for swaging 5/16 "oval sleeve.	28.00	5.00	3003 1005
HSC 1000 Combo	Swages 1/4 and 5/16" oval and stop sleeves.	39.77	16.52	3003 1010
BENCH SWAGER				
HSC 600BB	Swages 1/16, 5/64, 3/32, 7/64. 1/8, 5/32 and 3/16" oval and stop sleeves. Cutting feature included in jaw	21.26	11.45	3003 1001
#1 BSC	Swages 1/16", 3/32", 1 / 8 ", 5/32", and 3/16" oval and stop sleeves plus 7/32" stop sleeves.	22.50	6.60	3003 0001
PARTS AND GAUGES				
GA 1P	Sleeve gauge – 3/16" oval sleeves, 7/32, 1/4, 9/32 and 5/16" stops and ovals.			3003 2001
GA 2P	Sleeve gauge – 1/32, 3/64, 1/16, 3/32, 1/8, 5/32, 3/16" and 7/32 stops and ovals.			3003 2002
JAW	HSC – 600 Replacement Jaw.			3003 9003

MAINTENANCE:

- Clean and lubricate moving parts
- Check to make sure that all bolts are properly tightened
- Check to make sure that the swager is properly adjusted

SWAGING INSTRUCTIONS

Cable splicing is much easier if the cable is cut clean without frayed ends. We highly recommend the use of Felco cutting tools to achieve the best results. To determine which cable cutter is best suited for your application please refer to the Felco technical pages found on pages 56-59.

Crimps	Cable Size	Position
1	1/16	1
1	5/64	
2	3/32	2
2	7/64	
3	1/8	3
3	5/32	4
3	3/16	5

STEP 2 REQUIRED NUMBER OF SWAGES

PROPER INSERTION OF SLEEVE

1. Cut cable to the required length and lace the cable through the sleeve so that the end will protrude after crimping.
2. Properly insert sleeve into the correct cavity and line up the sleeve between the swager jaws with the long axis crosswise to the jaws.
3. Swage each sleeve the correct number of times following the swage sequence shown. Close lever handles completely until the swager snaps shut indicating complete closure.
4. Lap splice can be made by 2 oval sleeves. Keep a short space between the sleeves.

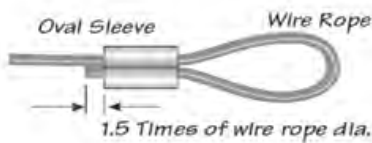

STEP 1

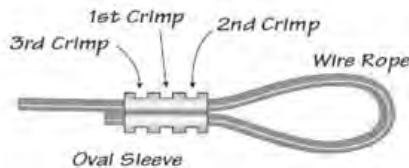

STEP 3



STEP 4 (LAP SPLICE)

Warning:

Swaging is accomplished on bare wire rope. If plastic wire rope is used, remove plastic coating as required.

Properly swaged oval sleeves will develop the published nominal breaking strength of the cable on 3 x 7; 7 x 7; and 7 x 19 constructions. Sleeves used on other constructions will not hold to the nominal published breaking strength.

WIRE ROPE HARDWARE

FLEMISH EYE SLEEVES

- Made from specially processed low carbon steel
- For use with 6 x 19 and 6 x 37 RRL classification steel wire ropes



Rope Size	Dimensions (before swage)					Maximum Dimensions (after swage)		Weight (lbs)	Vanguard Code
	A	B	D	E	G	1st Stage	2nd Stage		
1/4	1.00	0.66	0.31	0.28	0.47		0.57	0.045	2956 0016
5/16	1.50	0.91	0.38	0.44	0.62		0.08	0.137	2956 0020
3/8	1.50	0.91	0.47	0.39	0.66		0.75	0.120	2956 0024
7/16	2.00	1.22	0.53	0.65	0.85		1.01	0.310	2956 0028
1/2	2.00	1.22	0.63	0.56	0.91		1.01	0.280	2956 0032
9/16	2.75	1.47	0.70	0.63	1.03		1.24	0.630	2956 0036
5/8	2.75	1.47	0.75	0.63	1.09		1.24	0.500	2956 0040
3/4	3.19	1.72	0.91	0.84	1.28		1.46	0.900	2956 0048
7/8	3.56	2.03	1.03	1.00	1.53		1.68	1.380	2956 0056
1	4.00	2.28	1.16	1.13	1.72	2.00	1.93	1.900	2956 0100
1-1/8	4.81	2.50	1.28	1.25	1.94	2.25	2.13	2.570	2956 0108
1-1/4	5.19	2.78	1.44	1.41	2.16	2.50	2.32	3.440	2956 0116
1-3/8	5.81	3.00	1.56	1.56	2.36	2.75	2.52	4.200	2956 0124
1-1/2	6.25	3.25	1.69	1.69	2.63	2.87	2.71	4.880	2956 0132
1-3/4	7.25	3.84	1.94	1.97	3.13	3.84	3.10	7.850	2956 0148
2	8.50	4.38	2.25	2.25	3.63	3.81	3.56	11.000	2956 0200

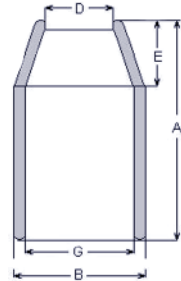

Note:

The cold swaging of dies is a delicate process, requiring considerate movement of the steel in the fitting, as it is forced under great pressure to flow into the crevices between wires and strand, as well as elongating parallel to the wire rope. For this reason, swaging must be performed by way of multiple pressings. This will also prevent excessive 'flashing', a term used to describe the material which is squeezed out into the area between the die faces. Excessive flashing can result in scoring and/or cracking of the sleeves!

**Inspect swaging dies frequently for nicks or scratches, which should be polished out!
Apply lubricants to the die blocks prior to swaging!**

After swaging, measure the OD of the sleeve and compare the results against the figures shown in the table to assure that the sleeve has been properly swaged.

BOLT CUTTERS

- Heavy duty high carbon machined steel jaws
- Multi-purpose adjustable jaws, with centre cut blades
- Heavy duty blades with a satin finish
- Blades clearance adjustable with eccentric nut
- Tubular steel handles with comfortable rubber handles maximize user comfort and prevent slipping when cutting.
- Suitable for cutting mild steel materials such as rods, bolts, rivets, bars and chain



Model No.	Capacity (inches)	Length (inches)	Weight (lbs)	Vanguard Code
WD 9-14	3/16	14	3.00	3004 0014
WD 9-18	1/4	18	5.50	3004 0018
WD 9-24	5/16	24	8.60	3004 0024
WD 9-30	3/8	30	10.00	3004 0030
WD 9-36	7/16	36	13.00	3004 0036
WD 9-42	1/2	42	18.00	3004 0042

MAINTENANCE:

- Clean and lubricate moving parts
- Check to make sure that all bolts are properly tightened
- Check to make sure that the blades and jaw are in good working condition before use

TIRE CHAIN PLIERS

Industrial grade chain pliers allow for quick and easy replacement of cross chains.

- Heat treated alloy steel jaws
- Opens and closes tire chain cross links
- Toggle joints turn 50lbs of hand pressure into 4,000lbs cutting pressure
- Tubular steel handles with rubber handles maximize user comfort and prevent slipping when cutting.



Model No.	Length (inches)	Weight (lbs)	Vanguard Code
7302 VGD-02	20.75	5.00	4004 0020
7302 VGD-01	32.50	7.00	4004 0030

* Not a standard stock item at all distribution centres.

TIRE CHAIN TENSIONERS

- A heavy duty tool with ratchet binder action designed to be used when installing tensioning of large tractor and skidder tire chains.
- Greatly simplifies and eases the proper installation/tensioning of snow chains.

Model No.	Weight (lbs)	Vanguard Code
VSCT	12.00	3819 9001



* Not a standard stock item at all distribution centres.

Warning:

Failure to follow these instructions can result in serious property damage, injury or death!

- Use extreme care when using these tools as they are capable of inflicting serious injury if misused
- **ALWAYS** make sure to keep hands and feet away from the jaws and all other moving parts

CHAIN



VANGUARD STEEL LTD.

TENSO/LION CHAIN (DOUBLE LOOP)

General purpose weldless utility chain, that combines strength, flexibility, light weight and neat appearance. Made with low carbon steel (not heat treated), zinc plated finish.

Commonly used for hardware and manufacturing applications such as playground and gym equipment, hanging of light fixtures, on gates, porch swings, halter, kennel, dog runner, cow ties and tie-out chains.

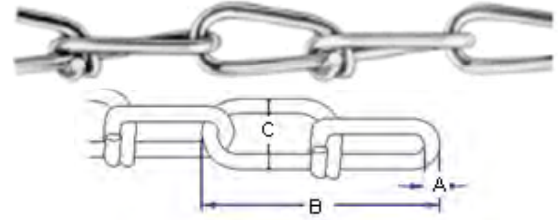

Trade Size	Dimensions (inches)			WLL (lbs)	Weight (lbs/100')	Pkg Qty (ft)	Vanguard Code	Pkg Qty (ft)	Vanguard Code
	A	B	C						
#4	0.07	1.14	0.20	70	6	100	3830 00041	250	3830 0004
#3	0.08	1.28	0.24	90	6	100	3830 00031	200	3830 0003
#2	0.09	1.97	0.28	115	9			100	3830 0002
#1	0.11	1.81	0.30	155	10			100	3830 0001
2/0	0.13	2.48	0.35	255	17	100	3830 02001	175	3830 0200

* Not a standard stock item at all distribution centres

** Additional sizes, materials, finishes and lengths available upon request. Minimum order quantity may apply.

SINGLE JACK CHAIN

General purpose weldless light duty chain, each link features two eyes 90° out of plane to each other. Made with low carbon steel (not heat treated), zinc plated finish.

Commonly used for hanging light fixtures, flower pots, children's toys, and general utility applications where high strength is not required



Trade Size	Dimensions (inches)			WLL (lbs)	Weight (lbs/100')	Pkg Qty (ft)	Vanguard Code	Pkg Qty (ft)	Vanguard Code
	A	B	C						
# 12	0.11	0.99	0.22	29	9	100	3830 5112		
# 10T	0.13	1.23	0.32	38	13	50	3830 50101	250	3830 50102
# 8	0.16	1.60	0.37	60	21	1000	3830 5108	100	3830 51081

* Not a standard stock item at all distribution centres

** Additional sizes, materials, finishes and lengths available upon request. Minimum order quantity may apply.

Warning:

NEVER EXCEED WORKING LOAD LIMITS!

Failure to follow these instructions can result in serious property damage, injury or death!

- **NEVER** to be used for overhead lifting or hoisting applications

CHAIN

GRADE 30 LONG LINK MOORING CHAIN

Mooring chain is a low carbon general purpose chain with a long link design, allowing the hook up of shackles anywhere on the chain, not just the end links. The long link makes it more flexible and ideally suited for mooring applications.



Made with low carbon steel, hot dipped galvanized finish offers excellent corrosion resistance. Sold in 100 Ft quantities (500 ft/pallet).

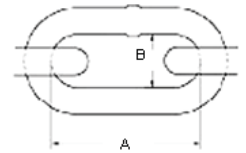

Diameter	Dimensions (inches)		Breaking Strength (lbs)	Weight (lbs/100')	Vanguard Code
	A	B			
1/2	3.00	0.88	15,000	230	3899 0032
3/4	4.15	1.19	39,500	480	3899 0048
1	4.15	2.00	55,000	860	3899 0100

* Not a standard stock item at all distribution centres

** Additional sizes, materials, finishes and lengths available upon request. Minimum order quantity may apply.

STRAIGHT LINK COIL CHAIN

General purpose welded chain; the link is easily identified as it is long and relatively narrow in proportion. Made with low carbon steel, hot dipped galvanized finish.

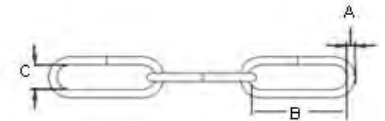
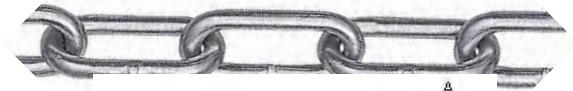

Commonly used for tail gates, safety chains, barriers and animal ties.

Trade Size	Dimensions (inches)			WLL (lbs)	Packaging (feet)	Weight (lbs/100')	Vanguard Code
	A	B	C				
4/0	0.22	1.39	0.38	670	500	35	3830 6040

* Not a standard stock item at all distribution centres

** Additional sizes, materials, finishes and lengths available upon request. Minimum order quantity may apply.

PASSING LINK CHAIN

General purpose welded chain; the design of the chain links eliminates the tendency to kink or knot. Made with low carbon steel, electro galvanized finish.



Commonly used for tie-out purposes on livestock, farm machinery, for gates and in the general utility industry.

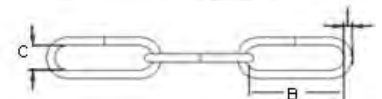

Trade Size	Dimensions (inches)			WLL (lbs)	Packaging (feet)	Weight (lbs/100')	Vanguard Code
	A	B	C				
2/0	0.19	0.88	0.47	450	100	32	3825 0020

* Not a standard stock item at all distribution centres

** Additional sizes, materials, finishes and lengths available upon request. Minimum order quantity may apply.

Warning:

NEVER EXCEED WORKING LOAD LIMITS!

Failure to follow these instructions can result in serious property damage, injury or death!

- **NEVER** to be used for overhead lifting or hoisting applications

T-316 STAINLESS STEEL CHAIN

An economical and commonly used chain that is highly corrosion resistant. Due to particular metallurgical structure of the base material it is a low magnetic product that is resistant to high temperatures.



Commonly used for industrial, salt water/marine application, also widely used in chemical plants.

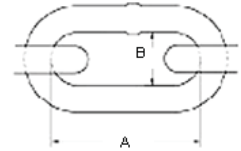

Dimensions (inches)			WLL (lbs)	Weight (lbs/100')	Vanguard Code
Diameter	A	B			
1/8	0.93	0.28	375	18	3816 0008
3/16	0.94	0.38	930	37	3816 0012
1/4	1.24	0.47	1,570	63	3816 0016
5/16	1.26	0.50	2,400	93	3816 0020
3/8	1.38	0.57	3,550	142	3816 0024
1/2	1.79	0.72	6,500	240	3816 0032

* Not a standard stock item at all distribution centres

** Additional sizes, materials, finishes and lengths available upon request. Minimum order quantity may apply.

TITAN ANTI-THEFT SECURITY CHAIN

This chain is manufactured to provide the highest possible security. Triple heat treated chain, made from square bar stock, with short pitch and inverted "V" welds to resist bolt cutters.

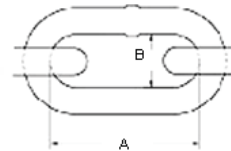
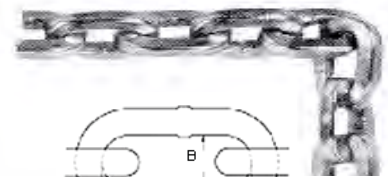

Surface hardness exceeds 65 Rockwell, electro galvanized finish provides excellent corrosion resistance.

Dimensions (inches)			WLL (lbs)	Weight (lbs/100')	Vanguard Code
Diameter	A	B			
3/8	1.50	0.62	3,150	400	3840 0024

* Not a standard stock item at all distribution centres

Warning:

NEVER EXCEED WORKING LOAD LIMITS!
Failure to follow these instructions can result in serious property damage, injury or death!

- NEVER to be used for overhead lifting or hoisting applications

CHAIN

GRADE 30 CHAIN EXACT

- Design factor 4:1
- Working Load Limits and weights for 'exact size' chains*
- Available in self-coloured, eletro or hot dip galvanized, or zinc plated finish



Chain Size	WLL (lbs)	Weight (lbs/100')	Half drums		Vanguard Code (self-colour)	Full drums		Vanguard Code (self-colour)
			feet	lbs		feet	lbs	
GRADE 30 SELF-COLOURED AND HOT DIP GALVANIZED CHAIN								
1/8	400	19	-	-	-	1,000	190	3802 0008
3/16	800	29	-	-	-	750	225	3802 0012
1/4	1,300	50	350	182	3802 00161	700	364	3802 0016
5/16	1,900	73	250	215	3802 00201	500	430	3802 0020
3/8	2,650	123	175	224	3802 00241	350	448	3802 0024
1/2	4,500	215	100	229	3802 00321	200	458	3802 0032
5/8	6,900	321	-	-	3802 00401	150	479	3802 0040
3/4	10,600	557	-	-	-	100	557	3802 0048
GRADE 30 ZINC PLATED CHAIN								
Size	WLL	Weight	Plastic pails		Zinc Code	Full drums		Zinc Code
1/8	400	19	350	67	3804 0008-350	1,000	190	3804 0008
3/16	800	29	250	73	3804 0012-250	800	232	3804 0012
1/4	1,300	50	140	70	3804 0016-140	450	225	3804 0016
5/16	1,900	73	90	66	3804 0020-090	275	201	3804 0020
3/8	2,650	123	-	-	-	200	246	3804 0024

Vanguard Prefix Codes for H. Galvanized finish - 3803

GRADE 30 EXACT SIZE

Chain Size	Material Diameter		Maximum WLL		Inside Length (nominal)		Inside Width (nominal)	
	inch	mm	lbs	kg	inch	mm	inch	mm
1/8	0.157	4.00	400	180	0.941	23.90	0.252	6.40
3/16	0.193	4.90	800	365	0.945	24.00	0.354	9.00
1/4	0.248	6.30	1,300	580	1.299	33.00	0.433	11.00
5/16	0.299	7.60	1,900	860	1.339	34.00	0.472	12.00
3/8	0.376	9.55	2,650	1,200	1.417	36.00	0.551	14.00
1/2	0.492	12.50	4,500	2,030	1.791	45.50	0.720	18.30
5/8	0.787	20.00	6,900	3,130	2.717	69.00	1.024	26.00
3/4	1.024	26.00	10,600	4,800	3.579	90.90	1.248	31.70

GRADE 40 CHAIN

- Design factor 3:1 (in accordance with NACM specifications)

Chain Size	WLL (lbs)	Galvanized Short Link		Galvanized Regular Link	
		Vanguard Code	(lbs/100')	Vanguard Code	(lbs/100')
1/4	2,600	3809 0016	74	3809 00161	73
5/16	3,900	3809 0020	110	3809 00201	106
3/8	5,400	3809 0024	153	3809 00241	142

Warning:

NEVER EXCEED WORKING LOAD LIMITS!

- NEVER use grade 30 or 40 chains for overhead lifting applications



NACM CHAIN SPECIFICATIONS

GRADE 30 PROOF COIL CHAIN

Chain Size		Material Diameter		WLL (maximum)		Proof Test (minimum)		Breaking Force (minimum)		Inside Length (maximum)		Inside Width (minimum)	
inch	mm	inch	mm	lbs	kg	lbs	kN	lbs	kN	inch	mm	inch	mm
1/8	4.0	0.156	4.0	400	180	800	3.6	1,600	7.20	0.94	23.90	0.25	6.40
3/16	5.5	0.217	5.5	800	365	1,600	7.2	3,200	14.40	0.98	24.80	0.30	7.70
1/4	7.0	0.276	7.0	1,300	580	2,600	11.6	5,200	23.20	1.24	31.50	0.38	9.80
5/16	8.0	0.331	8.4	1,900	860	3,800	16.9	7,600	33.80	1.29	32.80	0.44	11.20
3/8	10.0	0.394	10.0	2,650	1,200	5,300	23.6	10,600	47.20	1.38	35.00	0.55	14.00
7/16	11.9	0.488	11.9	3,700	1,680	7,400	32.9	14,800	65.80	1.64	41.60	0.65	16.60
1/2	13.0	0.512	13.0	4,500	2,030	9,000	40.0	18,000	80.00	1.79	45.50	0.72	18.20
5/8	16.0	0.630	16.0	6,900	3,130	13,800	61.3	27,600	122.60	2.20	56.00	0.79	20.00
3/4	20.0	0.787	20.0	10,600	4,800	21,200	94.3	42,400	188.60	2.76	70.00	0.98	25.00
7/8	22.0	0.866	22.0	12,800	5,810	25,600	114.1	51,200	228.20	3.03	77.00	1.08	27.50
1	26.0	1.020	26.0	17,900	8,140	35,800	159.1	71,600	318.20	3.58	90.90	1.25	31.70

GRADE 43 HIGH TEST CHAIN

Chain Size		Material Diameter		WLL (maximum)		Proof Test (minimum)		Breaking Force (minimum)		Inside Length (maximum)		Inside Width (minimum)	
inch	mm	inch	mm	lbs	kg	lbs	kN	lbs	kN	inch	mm	inch	mm
1/4	7.0	0.276	7.0	2,600	1,180	3,900	17.3	7,800	34.60	1.24	31.50	0.38	9.80
5/16	8.7	0.343	8.7	3,900	1,770	5,850	26.0	11,700	52.00	1.29	32.80	0.44	11.20
3/8	10.0	0.406	10.3	5,400	2,450	8,100	36.0	16,200	72.00	1.38	35.00	0.55	14.00
7/16	11.9	0.468	11.9	7,200	3,270	10,800	48.0	21,600	96.00	1.64	41.60	0.65	16.60
1/2	13.0	0.531	13.5	9,200	4,170	13,800	61.3	27,600	122.60	1.79	45.50	0.72	18.20
5/8	16.0	0.630	16.0	13,000	5,910	19,500	86.5	39,000	173.00	2.20	56.00	0.79	20.00
3/4	20.0	0.787	20.0	20,200	9,180	30,300	134.7	60,600	269.40	2.76	70.00	0.98	25.00
7/8	22.0	0.866	22.0	24,500	11,140	36,750	163.3	73,500	326.60	3.03	77.00	1.08	27.50

GRADE 70 TRANSPORT CHAIN

Chain Size		Material Diameter		WLL (maximum)		Proof Test (minimum)		Breaking Force (minimum)		Inside Length (maximum)		Inside Width (minimum)	
inch	mm	inch	mm	lbs	kg	lbs	kN	lbs	kN	inch	mm	inch	mm
1/4	7.0	0.281	7.0	3,150	1,430	6,300	28.0	12,600	56.00	1.24	31.50	0.38	9.80
5/16	8.7	0.343	8.7	4,700	2,130	9,400	41.8	18,800	83.60	1.29	32.80	0.44	11.20
3/8	10.0	0.406	10.3	6,600	2,990	13,200	58.7	26,400	117.40	1.38	35.00	0.55	14.00
7/16	11.9	0.468	11.9	8,750	3,970	17,500	77.8	35,000	155.40	1.64	41.60	0.65	16.60
1/2	13.0	0.531	13.5	11,300	5,130	22,600	100.4	45,200	200.80	1.79	45.50	0.72	18.20
5/8	16.0	0.630	16.0	15,800	7,170	31,600	140.4	63,200	280.80	2.20	56.00	0.79	20.00
3/4	20.0	0.787	20.0	24,700	11,200	49,400	219.6	98,800	439.20	2.76	70.00	0.98	25.00

CHAIN ACCESSORIES

'GOLD PIN'[®] CLEVIS GRAB HOOKS - CARBON STEEL

- For use with Grade 40 or lower grade chains only
- Self-coloured body with 'gold pin'

Size	WLL (lbs)	Dimensions (inches)				Weight (lbs)	Vanguard Code*
		A	B	C	D		
1/4	2,600	0.35	0.38	0.39	1.97	0.45	3930 0016
5/16	3,900	0.41	0.43	0.44	2.27	0.74	3930 0020
3/8	5,400	0.47	0.47	0.51	2.63	1.14	3930 0024
7/16	7,200	0.67	0.55	0.58	2.79	1.45	3930 0028
1/2	9,200	0.73	0.62	0.69	3.13	2.30	3930 0032

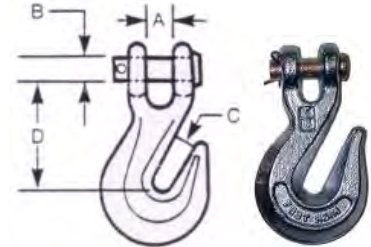

* For Galvanized Clevis Grab Hooks replace the 5th character of the product code with a "5" (example: 3930 5016 for 1/4" Galvanized)

'BLACK PIN'[®] CLEVIS GRAB HOOKS - ALLOY STEEL

- For use with Grade 70 or lower grade chains only
- Gold Chromated body with 'black pin'

Size	WLL (lbs)	Dimensions (inches)				Weight (lbs)	Vanguard Code
		A	B	C	D		
1/4	3,150	0.36	0.38	0.39	1.97	0.46	3931 0016
5/16	4,700	0.38	0.44	0.43	2.28	0.75	3931 0020
3/8	6,600	0.47	0.47	0.50	2.61	1.10	3931 0024
7/16	8,800	0.67	0.55	0.58	2.79	1.53	3931 0028
1/2	11,300	0.76	0.62	0.67	3.13	2.34	3931 0032

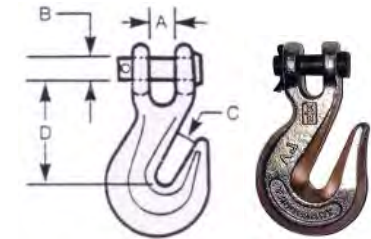

'GOLD PIN'[®] CLEVIS SLIP HOOKS - CARBON STEEL

- For use with Grade 40 or lower grade chains only
- Galvanized body with 'gold pin'

Size	WLL (lbs)	Dimensions (inches)				Weight (lbs)	Vanguard Code*
		A	B	C	D		
1/4	1,950	0.43	0.37	0.98	2.61	0.65	3903 00161
5/16	2,875	0.50	0.43	1.08	2.81	0.91	3903 00201
3/8	4,000	0.58	0.48	1.37	3.24	1.30	3903 00241
7/16	5,000	0.67	0.55	1.59	3.70	2.18	3903 00281
1/2	6,500	0.75	0.64	1.73	3.95	3.00	3903 00321

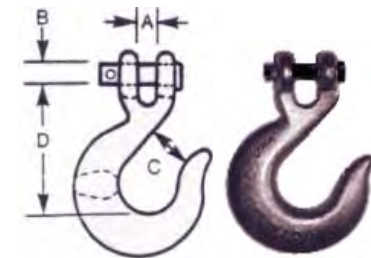

*For self-coloured clevis slip hooks, remove '1' at the end of part number (i.e. 3903 0016)

Note:

- Forged Carbon or Alloy Steel, heat treated
- Design Factor 4:1
- Refer to specific applications and warnings!

Warning:

NEVER EXCEED WORKING LOAD LIMITS!

- NEVER use grade 40 or 70 chains for overhead lifting applications
- ALWAYS discard hooks which show signs of deformation or excessive wear!

'BLACK PIN'® CLEVIS SLIP HOOKS - ALLOY STEEL

- For use with Grade 70 or lower grade chains only
- Gold Chromated body with 'black pin'
- Available with or without latches

Size	WLL (lbs)	Dimensions (inches)				Weight (lbs)	Vanguard Code*
		A	B	C	D		
1/4	2,750	0.43	0.38	0.98	2.52	0.65	3903 1016
5/16	4,300	0.51	0.43	1.10	2.82	0.92	3903 1020
3/8	5,250	0.58	0.47	1.33	3.22	1.32	3903 1024
7/16	7,000	0.67	0.54	1.61	3.69	2.07	3903 1028
1/2	9,000	0.76	0.62	1.74	3.99	2.90	3903 1032

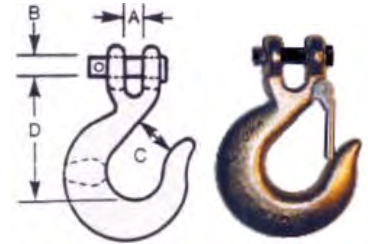

*For clevis slip hooks with latches, add '1' at the end of part number (i.e. 3903 10161)

EYE GRAB HOOKS - CARBON STEEL

- For use with Grade 40 or lower grade chains only

Size	WLL (lbs)	Dimensions (inches)			Weight (lbs)	Vanguard Code
		A	B	C		
1/4	2,600	0.53	1.92	0.34	0.30	3933 0016
5/16	3,900	0.61	2.29	0.43	0.51	3933 0020
3/8	5,400	0.80	2.65	0.49	0.88	3933 0024
1/2	9,200	0.89	3.21	0.65	1.79	3933 0032

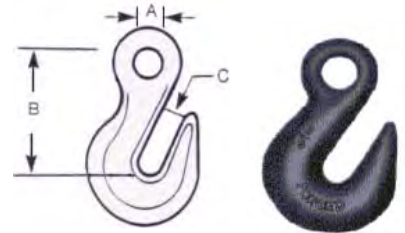

EYE SLIP HOOKS - CARBON STEEL

- For use with Grade 40 or lower grade chains only
- Galvanized

Size	WLL (lbs)	Dimensions (inches)			Weight (lbs)	Vanguard Code
		A	B	C		
1/4	1,950	0.50	2.54	0.94	0.49	3908 0016
5/16	2,875	0.62	2.92	1.07	0.62	3908 0020
3/8	4,000	0.73	3.34	1.33	0.98	3908 0024
1/2	6,500	0.94	4.04	1.66	2.52	3908 0032



Warning:

NEVER EXCEED WORKING LOAD LIMITS!

- **NEVER** use grade 40 or 70 chains for overhead lifting applications
- **ALWAYS** inspect hooks and latches frequently - Measure opening (C) and compare with dimensions shown. Increased opening indicates overloading!
- **ALWAYS** discard hooks which show signs of deformation or excessive wear!

CHAIN ACCESSORIES

QUICK LINKS

Multi-purpose connector that is very quick and easy to use – no tools required.

- Cold drawn mild steel - electro galvanized
- Reusable
- Use with chains of equal or lower working load limit (WLL)
- Working load limit (WLL) stamped on each piece
- Breaking strength 2 times WLL

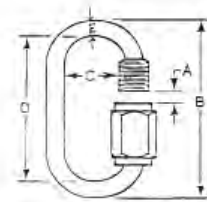

Chain Diameter	Dimensions (inches)					WLL (lbs)	Weight (lbs/pc)	Vanguard Code
	A	B	C	D	E			
1/8	0.21	1.44	0.38	1.17	0.13	220	0.02	2918 0008
3/16	0.26	1.93	0.51	1.54	0.20	660	0.05	2918 0012
1/4	0.30	2.24	0.55	1.77	0.24	880	0.08	2918 0016
5/16	0.43	2.95	0.64	2.35	0.30	1,760	0.18	2918 0020
3/8	0.47	3.23	0.71	2.55	0.35	2,200	0.23	2918 0024
7/16	0.52	3.64	0.79	2.88	0.40	2,640	0.32	2918 0028
1/2	0.57	4.13	0.93	3.19	0.47	3,300	0.52	2918 0032

* Stainless Steel Quick Links available upon request

PEAR SHAPED SNAP HOOKS

Multi-purpose connector that is very quick and easy to use – no tools required.

- Cold drawn mild steel - electro galvanized
- Reusable
- Working load limit (WLL) stamped on each piece
- Breaking strength 2 times WLL
- Not approved for climbing applications

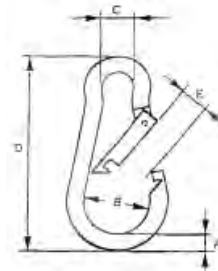

Chain Diameter	Dimensions (inches)					WLL (lbs)	Weight (lbs/pc)	Vanguard Code
	A	B	C	D	E			
1/8	0.16	0.48	0.24	1.60	0.28	200	0.02	2918 1008
3/16	0.20	0.58	0.32	1.99	0.26	220	0.06	2918 1012
1/4	0.23	0.68	0.36	2.37	0.30	260	0.08	2918 1016
5/16	0.30	0.93	0.47	3.53	0.89	500	0.14	2918 1020
3/8	0.38	1.20	0.63	3.94	1.08	770	0.29	2918 1024
1/2	0.46	1.70	0.72	5.47	1.61	1,400	0.72	2918 1032

Warning:

NEVER EXCEED WORKING LOAD LIMITS!

Failure to follow these instructions can result in serious property damage, injury or death!

- **NEVER** use for overhead lifting or hoisting, to support people, for playground or athletic equipment or as a safety device
- Do not use if visibly distorted or worn.

'S' HOOKS

Very versatile hook that can be used for both industrial and residential applications.

- Low Carbon steel - electro galvanized
- After engaging chain, close the "S" hooks to prevent disengagement
- Designed for light duty applications



Size (mm)	Dimensions (inches)		Weight (lbs/pc)	Vanguard Code
	A	B		
3 x 25	1.00	0.13	0.02	2930 0030
4 x 37	1.35	0.16	0.05	2930 0040
5 x 45	1.63	0.19	0.08	2930 0050
6 x 55	2.13	0.25	0.18	2930 0060
8 x 76	3.25	0.31	0.23	2930 0080
10 x 103	4.00	0.38	0.32	2930 0100

Additional shapes, styles, materials and finishes available upon request

TWIN AND DOUBLE CLEVIS LINKS

Designed for a variety of applications to join Grade 70 chain or lower grades of chain and/or components

- Body heat treated carbon steel, painted black and embossed with the chain diameter and V7
- Pins are quenched and tempered alloy steel, yellow chromate finished embossed with 'A'
- Reusable
- Ultimate load 4 times working load limit (WLL)



Chain Diameter	Dimensions (inches)				WLL (lbs)	Weight (lbs/pc)	Vanguard Code
	A	B	C	D			
TWIN CLEVIS LINKS							
1/4 - 5/16	0.44	1.24	0.38	0.46	4,700	0.31	3936 5020
3/8	0.52	1.38	0.47	0.50	6,600	0.54	3936 5024
1/2	0.65	1.72	0.57	0.61	11,250	1.18	3936 5032
DOUBLE CLEVIS LINKS							
5/16 - 3/8*	0.56	1.00	0.63	0.44	5,400	0.78	3935 0024

* Additional sizes available upon request

Warning:

NEVER EXCEED WORKING LOAD LIMITS!

Failure to follow these instructions can result in serious property damage, injury or death!

- **NEVER** use for overhead lifting or hoisting.
- Do not use if visibly distorted or worn.

CHAIN ACCESSORIES

COLD SHUTS

Very economical method for temporary repairing or connecting of low carbon proof coil chain with equal or lower working load limit (WLL).

- Mild steel - electro galvanized
- Use one size bigger than the chain being repaired/connected
- Use with chains of equal or lower working load limit (WLL)
- With a hammer, drive the open end through the cold shut eye and peen the extended end to prevent opening
- Never reuse after closure has been made
- Design factor 4:1



Diameter (inches)	Dimensions (inches)		WLL (lbs)	Weight (lbs/pc)	Vanguard Code
	A	B			
3/16	0.89	0.83	450	0.03	2917 0012
1/4	1.31	0.38	750	0.06	2917 0016
5/16	1.43	0.41	1,250	0.10	2917 0020
3/8	1.25	0.63	1,900	0.18	2917 0024
7/16	1.38	1.25	2,650	0.26	2917 0028
1/2	1.60	1.25	3,500	0.38	2917 0032

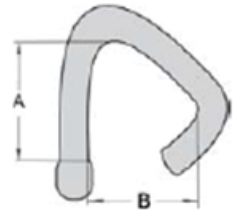

Not a standard stock item at all distribution centres

LAP LINKS

Very economical method for temporary repairing or connecting of low carbon proof coil chain with equal or lower working load limit (WLL).

- Cold drawn mild steel - electro galvanized
- Never reuse after closure has been made
- Use with chains of equal or lower working load limit (WLL)
- Thread onto chain link then flatten, link must be completely closed before using
- Design factor 4:1



Dimensions (inches)		WLL (lbs)	Weight (lbs/pc)	Vanguard Code
A	B			
3/16	1.00	240	0.03	2916 1210
1/4	2.00	400	0.04	2916 1620
5/16	2.00	950	0.17	2916 2020
3/8	2.00	1,250	0.26	2916 2420
1/2	2.50	1,525	0.53	2916 3225
5/8*	2.50	1,000	0.81	2916 4025

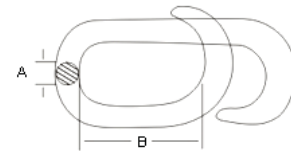

* Side opening

Not a standard stock item at all distribution centres

Warning:

NEVER EXCEED WORKING LOAD LIMITS!

Failure to follow these instructions can result in serious property damage, injury or death!

- **NEVER** use for overhead lifting or hoisting.
- Do not use if the chain or components are visibly distorted or worn.

GRADE 80 & 100 WARNINGS AND INFORMATION

It is very important to read and understand all information shown before using/assembling a chain sling

**WARNING****FAILURE TO OBSERVE THESE WARNINGS MAY RESULT IN SERIOUS INJURY OR DEATH!**

- **ALWAYS** make sure that chain slings, load chain and components are regularly inspected before use
- **ALWAYS** destroy and discard any sling that is damaged beyond repair
- **ALWAYS** make sure that the load is evenly balanced to avoid excessive forces when lifting
- **ALWAYS** make sure that the hook NOT the latch supports the load - NEVER tip load
- **ALWAYS** store chain slings in a dry clean environment
- **NEVER** exceed the working load limit (WLL) of the sling or any of its components – consult sling load charts for capacity reduction due to sling angle
- **NEVER** lift or transport loads over or near people
- **NEVER** use a chain sling for lifting or transporting people
- **NEVER** push or pull on the sling while under load
- **NEVER** use slings that appear defective, worn or damaged
- **NEVER** field weld or repair chain slings – all repairs should be performed by a competent/qualified repair facility
- **NEVER** expose slings to impact, rapid lifts or sudden stops
- **NEVER** tie knots to shorten slings
- **NEVER** fasten chain over sharp corners or edges
- **NEVER** use in highly acidic or caustic environments without first checking to see how the environment will affect the sling performance or capacity

High and low temperatures reduce the working load limit (WLL)!

Chain slings should not be in contact with objects or used in temperatures higher than 204°C (400°F) or lower than -40°C (-40°F)



SLING LOAD CHAIN AND COMPONENT INSPECTION:

All chain slings should be immediately removed from service if any of the following conditions are found. They should not be returned to service until repaired and recertified by a competent/qualified repair facility. If the unit cannot be repaired destroy and discard it.

- Missing or unreadable identification tags
- Cracks in the chain or components
- Excessive nicks, gouges, wear or corrosion
- Stretched, bent, twisted or distorted chain links or components
- Evidence of heat damage, field welding, welding spatter or any other condition which put the integrity of the chain sling in question

V-LINE CHAIN & ACCESSORIES

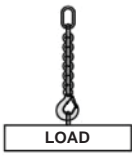
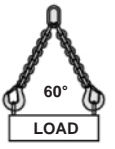
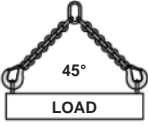
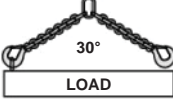
V-LINE GRADE 80 & 100 CHAIN SLINGS - LOAD CHART

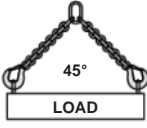
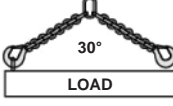
Chain Size (inches)	Single Leg Type "S"	Double Leg Type "D"			Triple Leg Type "T" and Quadruple Leg Type "Q"		
							
Grade 80 Working Load Limits (WLL)							
9/32	3,500	6,000	4,900	3,500	9,000	7,400	5,200
3/8	7,100	12,200	10,000	7,100	18,300	14,900	10,600
1/2	12,000	20,700	17,000	12,000	31,100	25,400	18,000
5/8	18,100	31,300	25,600	18,100	47,000	38,300	27,100
3/4	28,300	48,900	40,000	28,300	73,400	59,900	42,400
7/8	34,200	59,200	48,300	34,200	88,800	72,500	51,200
1	47,700	82,500	67,400	47,700	123,800	101,000	71,500
Grade 100 Working Load Limits (WLL)							
9/32	4,300	7,400	6,100	4,300	11,200	9,100	6,400
3/8	8,800	15,200	12,400	8,800	22,900	18,700	13,200
1/2	15,000	26,000	21,200	15,000	39,000	31,800	22,500
5/8	22,600	39,100	32,000	22,600	58,700	47,900	33,900

SINGLE LEG CHAIN SLING STYLES

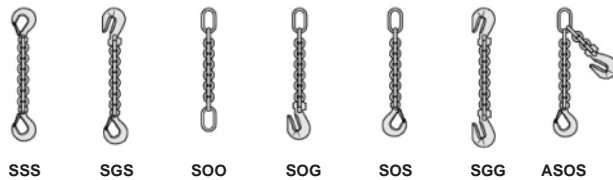

TRIPLE LEG CHAIN SLING STYLES



DOUBLE LEG CHAIN SLING STYLES

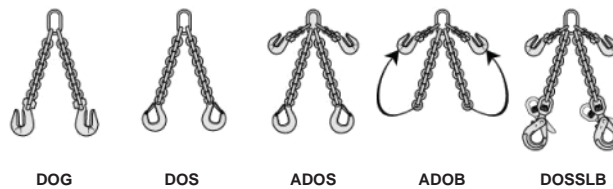

QUADRUPLE LEG CHAIN SLING STYLES

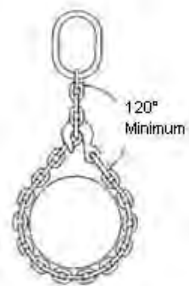

If a chain sling is used as a choker the working load limit (WLL) must be reduced by 20%. We recommend a minimum angle of choke of 120°



V-LINE CHAIN & ACCESSORIES

V-LINE GRADE 80 COMPONENT SELECTION GUIDE

Chain Size	Oblong Master Link	Master Link Sub-Assembly	Coupling Link	Clevis Grab Hook	Clevis Sling Hook	Self Locking Clevis Hook	Self Locking Eye Hook	Self Locking Swivel Hook
Single Leg Chain Sling								
9/32	3953 00322	N/A	3956 00161	3950 00161	3951 00161	3962 00161	3958 00161	3969 00161
3/8	3953 00402	N/A	3956 00241	3950 00241	3951 00241	3962 00241	3958 00241	3969 00241
1/2	3953 00482	N/A	3956 00321	3950 00321	3951 00321	3962 00321	39580 0321	3969 00321
5/8	3953 00562	N/A	3956 00401	3950 00401	3951 00401	3962 00401	39580 0401	3969 00401
Double Leg Chain Sling								
9/32	3953 00322	3954 00482	3956 00161	3950 00161	3951 00161	3962 00161	3958 00161	3969 00161
3/8	3953 00402	3954 01002	3956 00241	3950 00241	3951 00241	3962 00241	3958 00241	3969 00241
1/2	3953 00482	3954 01162	3956 00321	3950 00321	3951 00321	3962 00321	39580 0321	3969 00321
5/8	3953 00562	3954 01322	3956 00401	3950 00401	3951 00401	3962 00401	39580 0401	3969 00401
3/4	3953 01322	3954 01482	3956 00481	3950 00481	3951 00481	3962 00481		3969 00481
Triple Leg Chain Sling								
9/32	N/A	3954 00482	3956 00161	3950 00161	3951 00161	3962 00161	3958 00161	3969 00161
3/8	N/A	3954 01002	3956 00241	3950 00241	3951 00241	3962 00241	3958 00241	3969 00241
1/2	N/A	3954 01162	3956 00321	3950 00321	3951 00321	3962 00321	39580 0321	3969 00321
5/8	N/A	3954 01322	3956 00401	3950 00401	3951 00401	3962 00401	39580 0401	3969 00401
3/4	N/A	3954 01482	3956 00481	3950 00481	3951 00481	3962 00481		3969 00481
Quadruple (Quad) Leg Chain Sling								
9/32	N/A	3954 00482	3956 00161	3950 00161	3951 00161	3962 00161	3958 00161	3969 00161
3/8	N/A	3954 01002	3956 00241	3950 00241	3951 00241	3962 00241	3958 00241	3969 00241
1/2	N/A	3954 01162	3956 00321	3950 00321	3951 00321	3962 00321	39580 0321	3969 00321
5/8	N/A	3954 01322	3956 00401	3950 00401	3951 00401	3962 00401	39580 0401	3969 00401
3/4	N/A	3954 01482	3956 00481	3950 00481	3951 00481	3962 00481		3969 00481

* Additional components and larger chain slings available upon request

V-LINE GRADE 100 COMPONENT SELECTION GUIDE

Chain Size	Oblong Master Link	Master Link Sub-Assembly	Coupling Link	Clevis Grab Hook	Clevis Sling Hook	Self Locking Clevis Hook	Self Locking Eye Hook	Self Locking Swivel Hook
Single Leg Chain Sling								
9/32	3953 00323	N/A	3956 00163	3950 00163	3951 00163	3962 00163	3958 00163	3969 00163
3/8	3953 00403	N/A	3956 00243	3950 00243	3951 00243	3962 00243	3958 00243	3969 00243
1/2	3953 00483	N/A	3956 00323	3950 00323	3951 00323	3962 00323	39580 0323	3969 00323
5/8	3953 00563	N/A	3956 00403	3950 00403	3951 00403	3962 00403	39580 0403	3969 00403
Double Leg Chain Sling								
9/32	3953 00323	N/A	3956 00163	3950 00163	3951 00163	3962 00163	3958 00163	3969 00163
3/8	3953 00403	N/A	3956 00243	3950 00243	3951 00243	3962 00243	3958 00243	3969 00243
1/2	3953 00483	N/A	3956 00323	3950 00323	3951 00323	3962 00323	39580 0323	3969 00323
5/8	3953 00563	N/A	3956 00403	3950 00403	3951 00403	3962 00403	39580 0403	3969 00403
Triple Leg Chain Sling								
9/32	N/A	3954 00483	3956 00163	3950 00163	3951 00163	3962 00163	3958 00163	3969 00163
3/8	N/A	3954 01003	3956 00243	3950 00243	3951 00243	3962 00243	3958 00243	3969 00243
1/2	N/A	3954 01163	3956 00323	3950 00323	3951 00323	3962 00323	39580 0323	3969 00323
5/8	N/A	3954 01323	3956 00403	3950 00403	3951 00403	3962 00403	39580 0403	3969 00403
Quadruple (Quad) Leg Chain Sling								
9/32	N/A	3954 00483	3956 00163	3950 00163	3951 00163	3962 00163	3958 00163	3969 00163
3/8	N/A	3954 01003	3956 00243	3950 00243	3951 00243	3962 00243	3958 00243	3969 00243
1/2	N/A	3954 01163	3956 00323	3950 00323	3951 00323	3962 00323	39580 0323	3969 00323
5/8	N/A	3954 01323	3956 00403	3950 00403	3951 00403	3962 00403	39580 0403	3969 00403

* Additional components and larger chain slings available upon request

V-LINE CHAIN & ACCESSORIES

V-LINE GRADE 80 CHAIN

- Approved for overhead lifting
- Produced from the highest quality domestic alloy steel
- Heat treated
- Meet the specifications of NACM, ASTM and O.S.H.A.
- Permanently embossed with L8 (grade) and trace code every 6 links (alternating links)
- Design factor 4:1 (in accordance with NACM specifications)
- Black finish



Chain Size	WLL (lbs)	Material Diameter	Inside Length	Inside Width	Weight (lbs/100')	Full drums		Vanguard Code
						feet	lbs	
9/32	3,500	0.275	0.880	0.410	72	400	288	3808 00161
5/16	4,500	0.330	1.020	0.480	106	500	530	3808 00201
3/8	7,100	0.397	1.220	0.570	150	400	600	3808 00241
1/2	12,000	0.520	1.560	0.750	261	200	522	3808 00321
5/8	18,100	0.630	1.930	0.920	361	150	542	3808 00401
3/4	28,300	0.790	2.360	1.020	605	100	605	3808 00481
7/8	34,200	0.870	2.600	1.130	732	100	732	3808 00561
1	47,700	1.020	3.070	1.330	1,020	100	1,020	3808 01001

V-LINE GRADE 100 CHAIN

- Approved for overhead lifting
- Produced from the highest quality domestic alloy steel
- Heat treated
- Meet the specifications of NACM, ASTM and O.S.H.A.
- Permanently embossed with L10 (grade) and trace code every 6 links (alternating links)
- Design factor 4:1 (in accordance with NACM specifications)
- 25% Higher working load limit (WLL) than comparable Grade 80 Alloy Chain
- Grey armored finish



Chain Size	WLL (lbs)	Material Diameter	Inside Length	Inside Width	Weight (lbs/100')	Full drums		Vanguard Code
						feet	lbs	
9/32	4,300	0.275	0.880	0.410	72	800	576	3815 0018
3/8	8,800	0.397	1.220	0.570	150	400	600	3815 0024
1/2	15,000	0.520	1.560	0.750	261	200	522	3815 0032
5/8	22,600	0.630	1.930	0.920	361	150	542	3815 0040

Warning:

NEVER EXCEED WORKING LOAD LIMITS!

- **ONLY USE V-LINE GRADE 80 CHAINS** or higher for overhead lifting applications
- **ALWAYS** inspect chains & fittings prior to use

V-LINE GRADE 80 ALLOY MASTER LINKS

- Alloy Steel – Quenched and Tempered
- Individually proof tested per ASTM 906/952 prescribed loads
- Meet EN1677 standard (20,000 cycle fatigue test)
- Permanently embossed with VGD, size, model number and trace code
- Approved for overhead lifting when all components are grade 80
- Proof tested to 2 times the Working Load Limit (WLL)
- Design factor 4:1

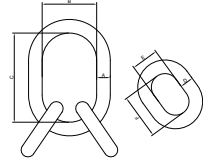

Dimensions (inches)			WLL (lbs)	Weight (lbs)	Sling Size & Type				Vanguard Code
A	B	C			Single	Double	Triple	Quad	
0.50	2.75	4.72	6,100	0.83	9/32-5/16	9/32			3953 00322
0.63	3.15	5.50	7,750	1.50	3/8	5/16			3953 00402
0.75	3.75	6.30	12,300	2.60	1/2	3/8	9/32 - 5/16	9/32 - 5/16	3953 00482
1.00	4.33	7.50	20,800	5.40	5/8	1/2	3/8	3/8	3953 01002
1.25	5.10	9.00	31,300	10.30	3/4	5/8	1/2	1/2	3953 01162
1.50	5.90	10.80	49,000	16.50	7/8	3/4	5/8	5/8	3953 01322
1.75	7.10	13.40	73,500	28.20	1	7/8	3/4	3/4	3953 01482
2.00	7.50	13.75	88,900	38.00	1-1/4	1	7/8	7/8	3953 02002

V-LINE GRADE 80 ALLOY SUB-ASSEMBLY

- Alloy Steel – Quenched and Tempered
- Individually proof tested per ASTM 906/952 prescribed loads
- Meet EN1677 standard (20,000 cycle fatigue test)
- Permanently embossed with VGD, size, model number and trace code
- Approved for overhead lifting when all components are grade 80
- Proof tested to 2 times the Working Load Limit (WLL)
- Design factor 4:1

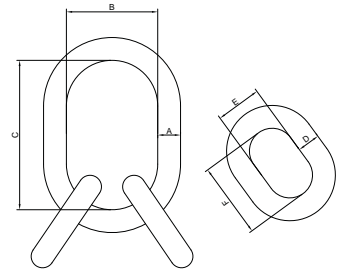

Chain Size	Dimensions (inches)						WLL (lbs @ 60°)	Weight (lbs)	Vanguard Code
	A	B	C	D	E	F			
9/32	0.75	3.75	6.30	0.50	2.36	4.33	12,300	4.20	3954 00482
3/8	1.00	4.33	7.50	0.75	3.75	6.30	20,800	10.70	3954 01002
1/2	1.25	5.10	9.00	1.00	4.33	7.50	31,300	22.30	3954 01162
5/8	1.50	5.90	10.80	1.13	5.10	9.05	49,000	32.40	3954 01322
3/4	1.75	7.10	13.40	1.25	5.10	9.05	73,500	58.60	3954 01482

Warning:

NEVER EXCEED WORKING LOAD LIMITS!

Failure to follow these instructions can result in serious property damage, injury or death!

- **ONLY USE V-LINE GRADE 80 CHAINS** or higher for overhead lifting
- **ALWAYS** inspect chain slings, load chain and components before use
- For more information see grade 80 & 100 warnings and information found in the chain section of this catalogue

V-LINE CHAIN & ACCESSORIES

V-LINE GRADE 80 ALLOY MASTER LINKS WITH FLAT SPOT

- Alloy Steel – Quenched and Tempered
- Individually proof tested per ASTM 906/952 prescribed loads
- Meet EN1677 standard (20,000 cycle fatigue test)
- Permanently embossed with VGD, size, model number and trace code
- Approved for overhead lifting when all components are grade 80
- Proof tested to 2 times the Working Load Limit (WLL)
- Design factor 4:1

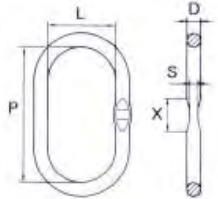

Dimensions (inches)			(mm)	WLL (lbs)	Weight (lbs)	Sling Size & Type				Vanguard Code
D	L	P	S x X			Single	Double	Triple	Quad	
1/2	2.75	4.72	8 x 25	6,100	0.80	9/32-5/16	9/32			3953 0032
5/8	3.15	5.50	8 x 25	7,750	1.55	3/8	5/16			3953 0040
3/4	3.75	6.30	11.5 x 35	12,300	2.70	1/2	3/8	9/32-5/16	9/32-5/16	3953 0048
1	4.33	7.50	14 x 45	20,800	5.30	5/8	1/2	3/8	3/8	3953 0100
1-1/4	5.10	9.00	18 x 45	31,300	9.75	3/4	5/8	1/2	1/2	3953 0116

* Not a standard stock item at all distribution centres

V-LINE GRADE 80 COUPLING LINKS

- Alloy Steel – Quenched and Tempered
- Meet or exceed ASTM A-952-96 standard
- Meet EN1677 standard (20,000 cycle fatigue test)
- Permanently embossed with VGD, size, model number and trace code
- Approved for overhead lifting when all components are grade 80
- Fast and easy assembly without the need for special tools
- Designed for attaching hooks, master links/sub-assemblies and other end fittings to Grade 80 alloy chain
- Proof tested to 2.5 times the Working Load Limit (WLL)
- Design factor 4:1

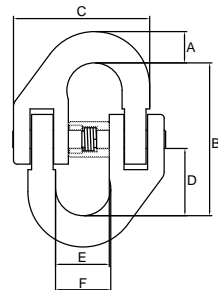

Chain Size	Dimensions (inches)						WLL (lbs)	Weight (lbs)	Vanguard Code
	A	B	C	D	E	F			
9/32	0.46	2.17	2.12	0.97	0.75	0.87	3,500	0.40	3956 00161
3/8	0.50	2.68	2.64	1.18	0.98	1.10	7,100	0.80	3956 00241
1/2	0.65	3.34	3.07	1.48	1.04	1.28	12,000	1.50	3956 00321
5/8	0.82	4.17	4.09	1.85	1.38	1.65	18,100	2.80	3956 00401
3/4	0.90	4.57	4.25	1.90	1.73	1.85	28,300	5.00	3956 00481
7/8	1.02	5.24	5.28	2.01	1.93	2.17	34,200	7.28	3956 00561

Warning:

NEVER EXCEED WORKING LOAD LIMITS!

Failure to follow these instructions can result in serious property damage, injury or death!

- **ONLY USE V-LINE GRADE 80 CHAINS** or higher for overhead lifting
- **ALWAYS** inspect chain slings, load chain and components before use
- For more information see grade 80 & 100 warnings and information found in the chain section of this catalogue

V-LINE GRADE 80 CLEVIS GRAB HOOKS

- Alloy Steel – Quenched and Tempered
- Meet or exceed ASTM A-952-96 standard
- Meet EN1677 standard (20,000 cycle fatigue test)
- Permanently embossed with VGD, size, model number and trace code
- Approved for overhead lifting when all components are grade 80
- Fast and easy assembly without the need for special tools
- Proof tested to 2.5 times the Working Load Limit (WLL)
- Design factor 4:1

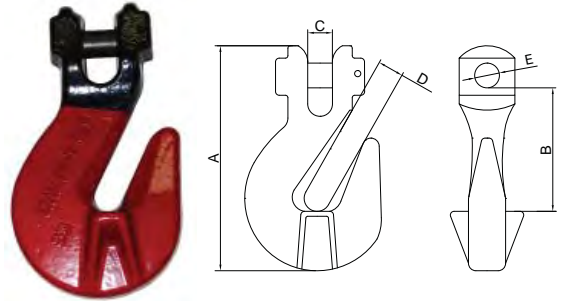

Chain Size	Dimensions (inches)					WLL (lbs)	Weight (lbs)	Vanguard Code
	A	B	C	D	E - Pin			
9/32 - 5/16	3.62	1.97	0.41	0.41	0.39	4,500	0.73	3950 00161
3/8	5.00	2.83	0.57	0.49	0.49	7,100	1.82	3950 00241
1/2	5.98	3.54	0.68	0.65	0.63	12,000	3.52	3950 00321
5/8	7.03	4.29	0.69	0.86	0.81	18,100	5.63	3950 00401
3/4	8.25	5.04	0.94	0.98	0.98	28,300	8.58	3950 00481
7/8	9.84	5.45	0.98	1.02	1.04	34,200	15.4	3950 00561

V-LINE GRADE 80 CLEVIS SLING HOOKS

- Alloy Steel – Quenched and Tempered
- Meet or exceed ASTM A-952-96 standard
- Meet EN1677 standard (20,000 cycle fatigue test)
- Permanently embossed with VGD, size, model number and trace code
- Approved for overhead lifting when all components are grade 80
- Fast and easy assembly without the need for special tools
- Proof tested to 2.5 times the Working Load Limit (WLL)
- Design factor 4:1

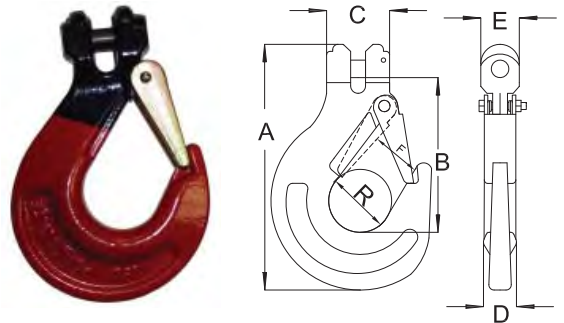

Chain Size	Dimensions (inches)							WLL (lbs)	Weight (lbs)	Vanguard Code
	A	B	C	D	E	F	R			
9/32 - 5/16	5.28	3.35	1.46	0.71	0.87	0.83	0.83	4,500	1.34	3951 10161
3/8	6.50	3.94	1.95	0.98	1.10	1.22	1.14	7,100	2.24	3951 10241
1/2	7.74	4.96	2.24	1.18	1.38	1.46	1.38	12,000	3.92	3951 10321
5/8	10.12	6.81	2.62	1.36	1.65	1.73	1.73	18,100	9.72	3951 10401
3/4	12.39	8.50	3.39	1.67	2.20	2.24	2.24	28,300	19.58	3951 10481
7/8	12.91	8.27	3.54	1.97	2.19	2.36	2.36	34,200	19.35	3951 10561

Warning:

NEVER EXCEED WORKING LOAD LIMITS!

Failure to follow these instructions can result in serious property damage, injury or death!

- **ONLY USE V-LINE GRADE 80 CHAINS** or higher for overhead lifting
- **ALWAYS** inspect chain slings, load chain and components before use
- For more information see grade 80 & 100 warnings and information found in the chain section of this catalogue

V-LINE CHAIN & ACCESSORIES

V-LINE GRADE 80 SELF LOCKING CLEVIS HOOKS

- Alloy Steel – Quenched and Tempered
- Meet or exceed ASTM A-952-96 standard
- Meet EN1677 standard (20,000 cycle fatigue test)
- Permanently embossed with VGD, size, model number and trace code
- Approved for overhead lifting when all components are grade 80
- Fast and easy assembly without the need for special tools
- The latch on this hook automatically closes when pulling force is applied
- Proof tested to 2.5 times the Working Load Limit (WLL)
- Design factor 4:1

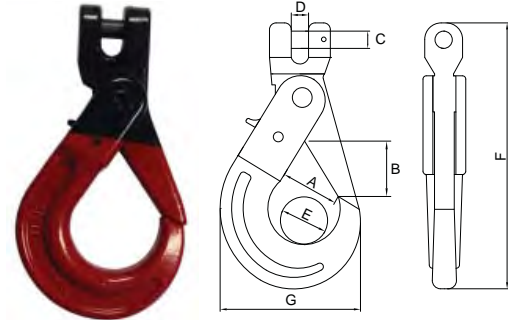

Chain Size	Dimensions (inches)											WLL (lbs)	Weight (lbs)	Vanguard Code
	A	B	C	D	E	F	H	I	J	K	L			
9/32 - 5/16	0.35	1.54	4.72	0.98	3.39	6.46	0.91	0.35	0.91	0.39	1.30	4,500	1.94	3962 00161
3/8	0.51	1.89	5.91	1.34	4.37	8.11	1.14	0.43	1.06	0.49	1.77	7,100	3.69	3962 00241
1/2	0.59	2.20	7.28	1.57	5.35	9.96	1.50	0.55	1.34	0.63	2.05	12,000	7.15	3962 00321
5/8	0.67	2.99	8.46	2.09	6.81	11.81	1.61	0.71	1.69	0.79	2.52	18,100	13.20	3962 00401
3/4	0.91	3.19	9.25	2.52	7.87	13.07	1.89	0.87	1.89	0.94	3.03	28,300	18.96	3962 00481

V-LINE GRADE 80 SELF LOCKING EYE HOOKS

- Alloy Steel – Quenched and Tempered
- Meet or exceed ASTM A-952-96 standard
- Meet EN1677 standard (20,000 cycle fatigue test)
- Permanently embossed with VGD, size, model number and trace code
- Approved for overhead lifting when all components are grade 80
- Fast and easy assembly without the need for special tools
- The latch on this hook automatically closes when pulling force is applied
- Proof tested to 2.5 times the Working Load Limit (WLL)
- Design factor 4:1

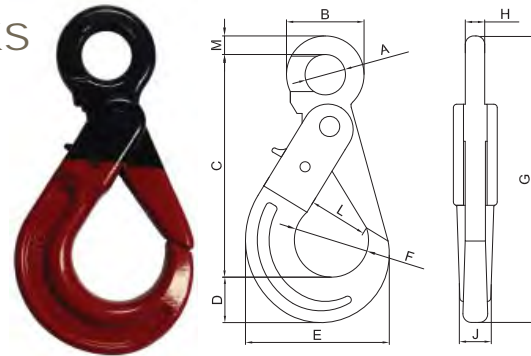

Chain Size	Dimensions (inches)											WLL (lbs)	Weight (lbs)	Vanguard Code
	A	B	C	D	E	F	H	I	J	L	M			
9/32 - 5/16	0.94	1.81	5.24	0.98	3.39	1.69	6.69	0.43	0.91	1.30	0.43	4,500	1.85	3958 00161
3/8	1.26	2.48	6.57	1.34	4.37	2.20	8.58	0.51	1.06	1.77	0.61	7,100	3.47	3958 00241
1/2	1.54	3.15	8.19	1.57	5.35	2.68	10.59	0.67	1.34	2.05	0.81	12,000	6.86	3958 00321
5/8	1.93	3.86	10.00	2.09	6.81	3.19	12.99	0.91	1.69	2.52	0.96	18,100	13.00	3958 00401

Warning:

NEVER EXCEED WORKING LOAD LIMITS!

Failure to follow these instructions can result in serious property damage, injury or death!

- **ONLY USE V-LINE GRADE 80 CHAINS** or higher for overhead lifting
- **ALWAYS** inspect chain slings, load chain and components before use
- For more information see grade 80 & 100 warnings and information found in the chain section of this catalogue

V-LINE GRADE 80 SELF LOCKING SWIVEL HOOKS

- Alloy Steel – Quenched and Tempered
- Meet or exceed ASTM A-952-96 standard
- Meet EN1677 standard (20,000 cycle fatigue test)
- Permanently embossed with VGD, size, model number and trace code
- Approved for overhead lifting when all components are grade 80
- Fast and easy assembly without the need for special tools
- Suitable for infrequent, non-continuous rotation under load
- The latch on this hook automatically closes when pulling force is applied
- Proof tested to 2.5 times the Working Load Limit (WLL)
- Design factor 4:1

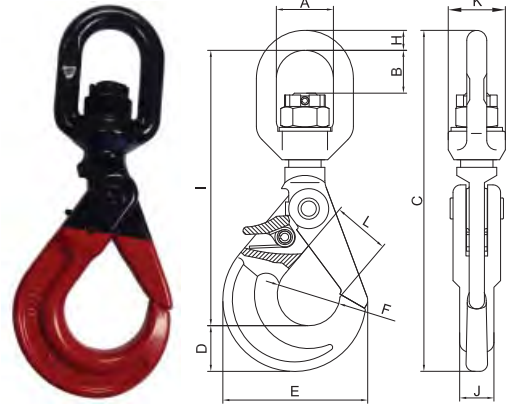

Chain Size	Dimensions (inches)											WLL (lbs)	Weight (lbs)	Vanguard Code
	A	B	C	D	E	F	H	I	J	K	L			
9/32 - 5/16	1.34	1.22	9.06	0.98	3.39	1.69	0.55	7.44	0.91	1.57	1.30	4,500	2.64	3969 00161
3/8	1.65	1.57	11.02	1.34	4.37	2.20	0.63	9.02	1.06	1.77	1.77	7,100	4.95	3969 00241
1/2	2.05	1.93	13.78	1.57	5.35	2.68	0.87	11.22	1.34	2.28	2.05	12,000	9.09	3969 00321
5/8	2.36	1.93	16.14	2.09	6.81	3.19	0.91	13.19	1.69	2.68	2.52	18,100	16.83	3969 00401
3/4	2.91	2.68	18.50	2.52	7.87	3.90	1.06	14.76	1.89	2.95	3.03	28,300	26.24	3969 00481

Warning:

NEVER EXCEED WORKING LOAD LIMITS!

Failure to follow these instructions can result in serious property damage, injury or death!

- **ONLY USE V-LINE GRADE 80 CHAINS** or higher for overhead lifting
- **ALWAYS** inspect chain slings, load chain and components before use
- For more information see grade 80 & 100 warnings and information found in the chain section of this catalogue

V-LINE CHAIN & ACCESSORIES

V-LINE GRADE 100 ALLOY MASTER LINKS

- Alloy Steel – Quenched and Tempered
- Individually proof tested per ASTM 906/952 prescribed loads
- Meet EN1677 standard (20,000 cycle fatigue test)
- Approved for overhead lifting when all components are GR100
- Proof tested to 2 times the Working Load Limit (WLL)
- Design factor 4:1

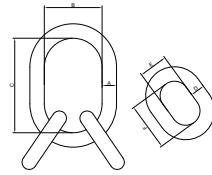

Dimensions (inches)			WLL (lbs)	Weight (lbs)	Vanguard Code
A	B	C			
0.51	2.36	4.33	8,600	0.83	3953 00323
0.63	2.36	4.33	11,400	1.50	3953 00403
0.75	2.95	5.31	17,600	2.60	3953 00483
0.90	3.54	6.30	14,991	3.53	3953 00563

V-LINE GRADE 100 ALLOY SUB-ASSEMBLY

- Alloy Steel – Quenched and Tempered
- Individually proof tested per ASTM 906/952 prescribed loads
- Meet EN1677 standard (20,000 cycle fatigue test)
- Permanently embossed with VGD, size, model number and trace code
- Approved for overhead lifting when all components are GR100
- Proof tested to 2 times the Working Load Limit (WLL)
- Design factor 4:1

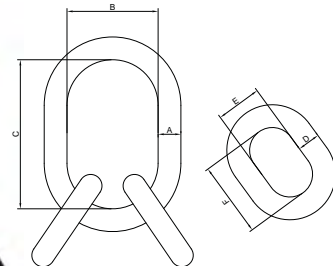

Chain Size	Dimensions (inches)						WLL (lbs)	Weight (lbs)	Vanguard Code
	A	B	C	D	E	F			
9/32-5/16	0.75	2.76	5.51	0.51	1.38	2.28	15,200	3.80	3954 00483
3/8	0.87	3.54	6.30	0.63	1.34	2.76	22,900	8.00	3954 01003
1/2	1.02	3.94	7.09	0.71	1.57	3.35	39,000	13.30	3954 01163
5/8	1.26	4.33	7.87	0.87	1.97	4.53	47,730	21.08	3954 01323

Warning:

NEVER EXCEED WORKING LOAD LIMITS!

Failure to follow these instructions can result in serious property damage, injury or death!

- **ONLY USE V-LINE GRADE 100 CHAINS** or higher for overhead lifting
- **ALWAYS** inspect chain slings, load chain and components before use

V-LINE GRADE 100 COUPLING LINKS

- Alloy Steel – Quenched and Tempered
- Meet or exceed ASTM A-952-96 standard
- Meet EN1677 standard (20,000 cycle fatigue test)
- Permanently embossed with VGD, size, model number and trace code
- Approved for overhead lifting when all components are GR100
- Fast and easy assembly without the need for special tools
- Designed for attaching hooks, master links/sub-assemblies and other end fittings to GRADE 100 alloy chain
- Proof tested to 2.5 times the Working Load Limit (WLL)
- Design factor 4:1

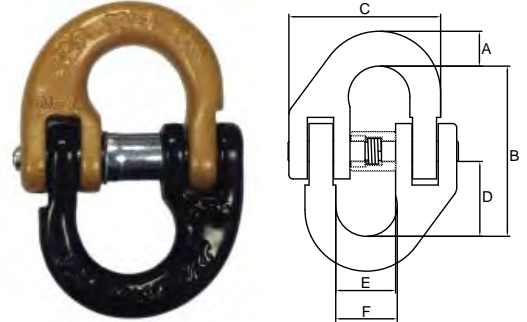

Chain Size	Dimensions (inches)						WLL (lbs)	Weight (lbs)	Vanguard Code
	A	B	C	D	E	F			
9/32	0.43	2.20	1.97	0.98	0.79	0.91	4,300	0.40	3956 00163
3/8	0.55	2.68	2.40	1.18	0.98	1.14	8,800	0.76	3956 00243
1/2	0.73	3.23	2.99	1.42	1.18	1.34	15,000	1.50	3956 00323
5/8	0.83	4.09	3.76	1.81	1.42	1.61	22,600	2.80	3956 00403

V-LINE GRADE 100 CLEVIS GRAB HOOKS

- Alloy Steel – Quenched and Tempered
- Meet or exceed ASTM A-952-96 standard
- Meet EN1677 standard (20,000 cycle fatigue test)
- Permanently embossed with VGD, size, model number and trace code
- Approved for overhead lifting when all components are GR100
- Fast and easy assembly without the need for special tools
- Proof tested to 2.5 times the Working Load Limit (WLL)
- Design factor 4:1

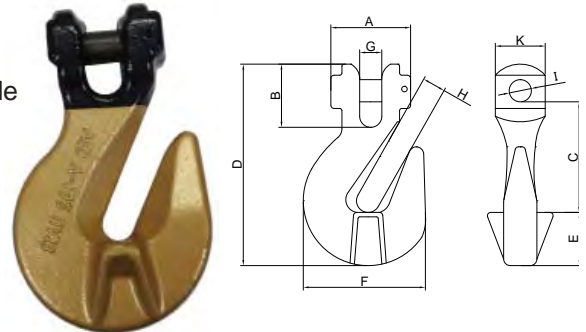

Chain Size	Dimensions (inches)										WLL (lbs)	Weight (lbs)	Vanguard Code
	A	B	C	D	E	F	G	H	I	K			
9/32 - 5/16	1.54	1.10	1.97	3.80	1.02	2.28	0.37	0.39	0.41	0.89	5,700	0.73	3950 00163
3/8	1.81	1.44	2.76	5.04	1.46	2.91	0.47	0.47	0.51	1.10	8,800	1.82	3950 00243
1/2	2.26	1.73	3.39	6.08	1.65	3.66	0.63	0.59	0.65	1.38	15,000	3.52	3950 00323
5/8	2.64	2.20	3.94	7.09	1.81	4.23	0.71	0.87	0.81	1.57	22,600	5.63	3950 00403

Warning:

NEVER EXCEED WORKING LOAD LIMITS!

Failure to follow these instructions can result in serious property damage, injury or death!

- **ONLY USE V-LINE GRADE 100 CHAINS** or higher for overhead lifting
- **ALWAYS** inspect chain slings, load chain and components before use

V-LINE CHAIN & ACCESSORIES

V-LINE GRADE 100 CLEVIS SLING HOOKS

- Alloy Steel – Quenched and Tempered
- Meet or exceed ASTM A-952-96 standard
- Meet EN1677 standard (20,000 cycle fatigue test)
- Permanently embossed with VGD, size, model number and trace code
- Approved for overhead lifting when all components are GRADE 100
- Fast and easy assembly without the need for special tools
- Proof tested to 2.5 times the Working Load Limit (WLL)
- Design factor 4:1

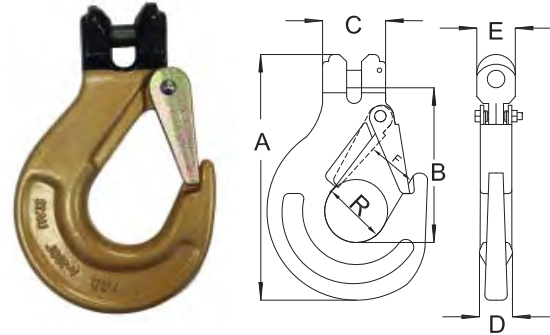

Chain Size	Dimensions (inches)							WLL (lbs)	Weight (lbs)	Vanguard Code
	A	B	C	D	E	F	R			
9/32 - 5/16	5.28	3.35	1.46	0.71	0.87	0.83	0.83	5,700	1.34	3951 00163
3/8	6.50	3.94	1.95	0.98	1.10	1.22	1.14	8,800	2.24	3951 00243
1/2	7.74	4.96	2.24	1.18	1.38	1.46	1.38	15,000	3.92	3951 00323
5/8	10.12	6.81	2.62	1.36	1.65	1.73	1.73	22,600	9.72	3951 00403

V-LINE GRADE 100 SELF LOCKING CLEVIS HOOKS

- Alloy Steel – Quenched and Tempered
- Meet or exceed ASTM A-952-96 standard
- Meet EN1677 standard (20,000 cycle fatigue test)
- Permanently embossed with VGD, size, model number and trace code
- Approved for overhead lifting when all components are GRADE 100
- Fast and easy assembly without the need for special tools
- The latch on this hook automatically closes when pulling force is applied
- Proof tested to 2.5 times the Working Load Limit (WLL)
- Design factor 4:1

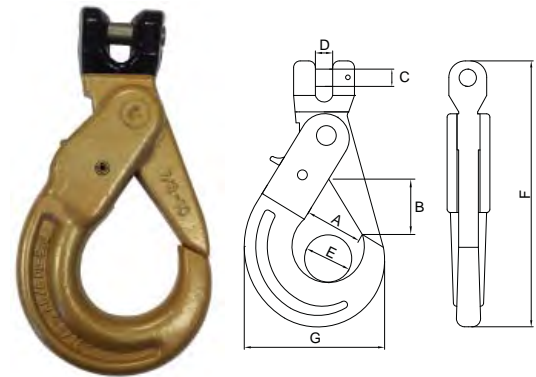

Chain Size	Dimensions (inches)											WLL (lbs)	Weight (lbs)	Vanguard Code
	A	B	C	D	E	F	H	I	J	K	L			
9/32 - 5/16	0.35	1.54	4.72	0.98	3.39	6.46	0.91	0.35	0.91	0.39	1.30	5,700	1.94	3962 00163
3/8	0.51	1.89	5.91	1.34	4.37	8.11	1.14	0.43	1.06	0.49	1.77	8,800	3.69	3962 00243
1/2	0.59	2.20	7.28	1.57	5.35	9.96	1.50	0.55	1.34	0.63	2.05	15,000	7.15	3962 00323
5/8	0.67	2.99	8.46	2.09	6.81	11.81	1.61	0.71	1.69	0.79	2.52	22,600	13.20	3962 00403

Warning:

NEVER EXCEED WORKING LOAD LIMITS!

Failure to follow these instructions can result in serious property damage, injury or death!

- **ONLY USE V-LINE GRADE 100 CHAINS** or higher for overhead lifting
- **ALWAYS** inspect chain slings, load chain and components before use

V-LINE GRADE 100 SELF LOCKING EYE HOOKS

- Alloy Steel – Quenched and Tempered
- Meet or exceed ASTM A-952-96 standard
- Meet EN1677 standard (20,000 cycle fatigue test)
- Permanently embossed with VGD, size, model number and trace code
- Approved for overhead lifting when all components are GRADE 100
- Fast and easy assembly without the need for special tools
- The latch on this hook automatically closes when pulling force is applied
- Proof tested to 2.5 times the Working Load Limit (WLL)
- Design factor 4:1

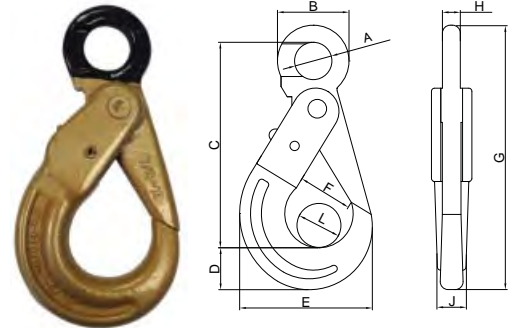

Chain Size	Dimensions (inches)										WLL (lbs)	Weight (lbs)	Vanguard Code
	A	B	C	D	E	F	G	H	J	L			
9/32 - 5/16	0.94	1.81	5.24	0.98	3.39	1.69	6.69	0.43	0.91	1.30	5,700	1.85	3958 00163
3/8	1.26	2.48	6.57	1.34	4.37	2.20	8.58	0.51	1.06	1.77	8,800	3.47	3958 00243
1/2	1.54	3.15	8.19	1.57	5.35	2.68	10.59	0.67	1.34	2.05	15,000	6.86	39580 0323
5/8	1.93	3.86	10.00	2.09	6.81	3.19	12.99	0.91	1.69	2.52	22,600	13.00	39580 0403

V-LINE GRADE 100 SELF LOCKING SWIVEL HOOKS

- Alloy Steel – Quenched and Tempered
- Meet or exceed ASTM A-952-96 standard
- Meet EN1677 standard (20,000 cycle fatigue test)
- Permanently embossed with VGD, size, model number and trace code
- Approved for overhead lifting when all components are GRADE 100
- Fast and easy assembly without the need for special tools
- The latch on this hook automatically closes when pulling force is applied
- Proof tested to 2.5 times the Working Load Limit (WLL)
- Design factor 4:1

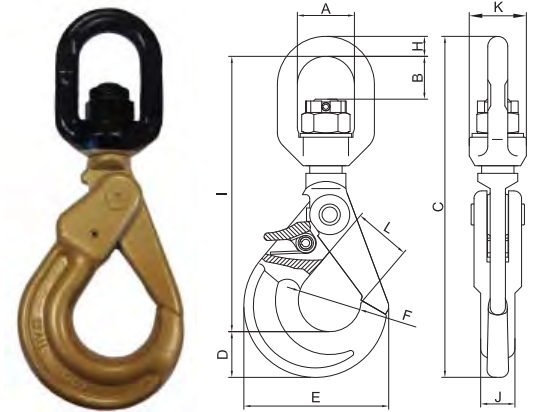

Chain Size	Dimensions (inches)											WLL (lbs)	Weight (lbs)	Vanguard Code
	A	B	C	D	E	F	H	I	J	K	L			
9/32 - 5/16	1.34	1.22	9.06	0.98	3.39	1.69	0.55	7.44	0.91	1.57	1.30	5,700	1.85	3969 00163
3/8	1.65	1.57	11.02	1.34	4.37	2.20	0.63	9.02	1.06	1.77	1.77	8,800	3.47	3969 00243
1/2	2.05	1.93	13.78	1.57	5.35	2.68	0.87	11.22	1.34	2.28	2.05	15,000	6.86	3969 00323
5/8	2.36	1.93	16.14	2.09	6.81	3.19	0.91	13.19	1.69	2.68	2.52	22,600	13.00	3969 00403

Warning:

NEVER EXCEED WORKING LOAD LIMITS!

Failure to follow these instructions can result in serious property damage, injury or death!

- **ONLY USE V-LINE GRADE 100 CHAINS** or higher for overhead lifting
- **ALWAYS** inspect chain slings, load chain and components before use

V-LINE CHAIN & ACCESSORIES

SLING IDENTIFICATION TAGS

- Pre-stamped metal tag
- Markings include sling type, working load limit (WLL), reach, serial number, chain size and grade

Sling Type	Vanguard Code
Single Leg	3963 0001
Multiple Leg	3963 0002

* Tags may not be exactly as shown

FRONT



BACK



V-LINE GRADE 80 & 100 STANDARD SPARE PARTS LISTING

Chain Size (inches)	Vanguard Code
Steel Collar	
9/32	3956 10161
3/8	3956 10241
1/2	3956 10321
5/8	3956 10401
3/4	3956 10481
Load Pin	
9/32	3950 10161
9/32	3950 10162
3/8	3950 10241
1/2	3950 10321
5/8	3950 10401
5/8	3950 10402
3/4	3950 10481
3/4	3950 10482
Cast Latch Kit	
9/32 - 5/16	3961 10161
3/8	3961 10241
1/2	3961 10321
5/8	3961 10401
3/4	3961 10481
Trigger Kit Assembly	
9/32 - 5/16	3969 10161
3/8	3969 10241
1/2	3969 10321
5/8	3969 10401



Warning:

NEVER EXCEED WORKING LOAD LIMITS!

Failure to follow these instructions can result in serious property damage, injury or death!

- **ONLY USE V-LINE GRADE 80 CHAINS** or higher for overhead lifting
- **ALWAYS** inspect chain slings, load chain and components before use
- For more information see grade 80 & 100 warnings and information found in the chain section of this catalogue

CARGO CONTROL PRODUCTS



VANGUARD STEEL LTD.

LOAD BINDERS WARNINGS AND INFORMATION

It is very important to read and understand all information shown before using a load binder



Lever



Ratchet



Recoilless



WARNING

FAILURE TO OBSERVE THESE WARNINGS MAY RESULT IN SERIOUS INJURY OR DEATH!

Load binders should only be used by properly trained/competent people that are familiar with all provincial/state and federal regulations regarding the size of and number of chain systems that are required to secure loads on trucks.

- **ALWAYS** inspect load binders for wear, bending, cracks, nicks and/or gouges BEFORE use. Load binders that are not functioning properly or show signs of bending or cracks must be removed from service immediately.
- **ALWAYS** move handle using extreme caution, as it may whip.
- **ALWAYS** keep your body clear of the path of the moving handle and loose chain that may be laying on the handle.
- **ALWAYS** make sure that your footing is stable/secure before using a load binder.
- **ALWAYS** be aware of your surroundings when using load binders, making sure to take the safety of nearby workers and yourself into consideration before use.
- **ALWAYS** secure the position of the load binder by wrapping the loose end of the chain around the handle.
- **NEVER** exceed the working load limit of the load binder, chain or components.
- **NEVER** operate a load binder when you or anyone else is standing on the load.
- **NEVER** close your hand around the handle.
- **NEVER** allow the load binder to bear against an object when under load, as this will cause side load.
- **NEVER** use a cheater bar/pipe/handle extender.
- **NEVER** attempt to open or close a load binder with more than one person.

MAINTENANCE:

Routinely lubricate ball and socket joints to extend service life. For ratchet load binders the pawl parts and screw threads should also be lubricated to reduce friction wear.

CARGO CONTROL PRODUCTS

RECOILLESS LOAD BINDERS

Recoilless/in-direct load binders provide greater safety and ease of use than standard lever type load binders.

- Forged Steel - quenched and tempered
- Hooks can rotate 360° for easier use
- Continuous take up
- Design prevents whipping/kick back of handle
- Handle moves freely without storing load tension
- Binder toggles away from load
- Yellow chromate finish, embossed with VGD, Trace Code, WLL, MBS and chain dimensions
- Design Factor 3.5:1

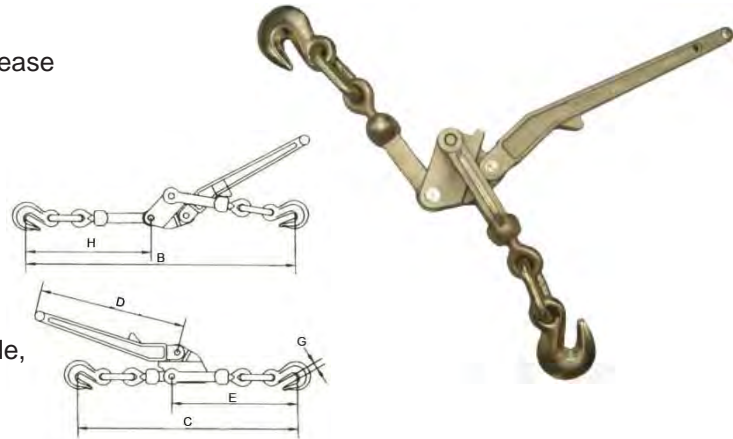

Chain Size	Dimensions (inches)								WLL (lbs)	Breaking Strength (lbs)	Weight (lbs)	Vanguard Code
	A	B	C	D	E	F	G	Take up				
5/16 - 3/8	24.10	23.70	19.70	13.20	11.00	11.00	0.51	4.50	5,400	19,000	9.20	3906 0024
3/8 - 1/2	27.00	25.50	22.00	18.50	12.50	12.50	0.60	4.50	9,200	33,000	15.00	3906 0032

RATCHET TYPE LOAD BINDERS

Ratchet load binders offer a quick, easy and safe means of tightening load securing chain assemblies.

- Forged Steel - quenched and tempered
- Continuous take-up
- Binder toggles away from load
- Painted red with black hooks, embossed with VGD, Trace Code, WLL and chain dimensions
- Design Factor 3.5:1

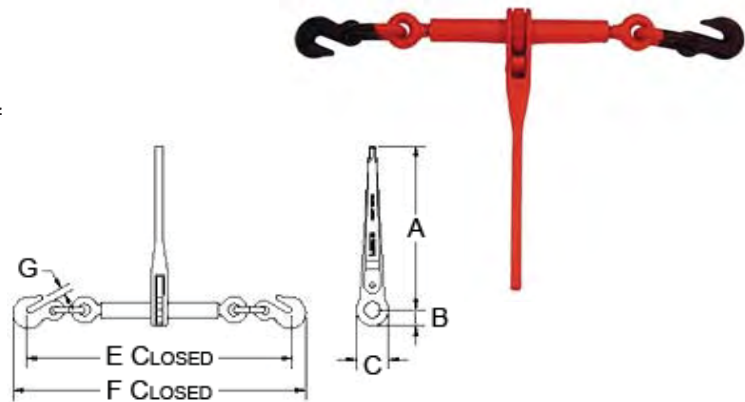

Chain Size	Dimensions							WLL (lbs)	Breaking Strength (lbs)	Weight (lbs)	Vanguard Code
	A	B	C	D	E	F	Take up				
1/4	6.80	0.88	1.57	16.00	17.80	0.32	5.00	2,600	7,800	4.00	3905 0016
5/16 - 3/8	14.00	1.38	2.75	23.00	25.30	0.50	8.00	5,400	19,000	10.50	3905 0024
5/16 - 3/8	14.00	1.38	2.75	23.00	25.30	0.50	8.00	6,600	26,000	11.03	3905 1024
3/8 - 1/2	14.00	1.38	2.75	25.20	28.50	0.60	8.00	9,200	33,000	13.00	3905 0032
1/2 - 5/8	14.30	1.40	2.50	26.00	29.00	0.70	9.00	13,000	46,000	15.00	3905 0040

Warning:

**NEVER EXCEED WORKING LOAD LIMITS!
FAILURE TO FOLLOW INSTRUCTIONS CAN RESULT IN SERIOUS INJURY!**

- For more detailed information please refer to load binder warnings and information section of this catalogue

LEVER TYPE LOAD BINDERS

Load binders are used for easy and efficient tightening of chain used for lashing purposes.

- Forged Steel - quenched and tempered
- Ball and socket swivel joints at hook assemblies permit a straight line pull
- Painted red with black hooks, embossed with VGD, Trace Code, WLL and chain dimensions
- Design Factor 3.5:1

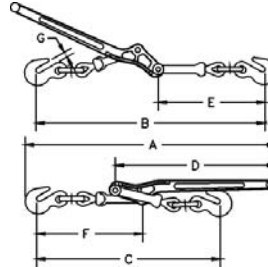

Chain Size	Dimensions (inches)								WLL (lbs)	NBS (lbs)	Weight (lbs)	Vanguard Code
	A	B	C	D	E	F	G	Take up				
1/4	20.00	17.90	13.70	11.60	8.00	8.00	0.36	3.62	2,600	7,800	2.4	3904 0016
5/16 - 3/8	24.10	22.10	17.90	16.00	10.40	10.40	0.50	4.25	5,400	19,000	7.0	3904 0024
5/16 - 3/8	24.10	22.10	17.90	16.00	10.40	10.40	0.50	4.25	6,600	19,800	7.4	3904 1024
3/8 - 1/2	27.00	25.50	22.00	18.50	12.50	12.50	0.60	4.25	9,200	33,000	10.5	3904 0032

LOAD BINDER LOCKS

Load binder locks are designed to fit over load binder handles, locking into place with the aid of the steel spring clip. The U-shaped bracket fits over either the transport chain or the load binder handle.

The steel spring clip allows for the operator to either clip through the transport chain, around the load binder handle or through the hole found on most load binder handle and then around the transport chain



Vanguard Code: 3904 0001

LOAD TIGHTENERS

- For 3/16" chain - light duty applications only
- WLL 250 lbs

Vanguard Code: 3904 0012



Warning:

**NEVER EXCEED WORKING LOAD LIMITS!
FAILURE TO FOLLOW INSTRUCTIONS CAN RESULT IN SERIOUS INJURY!**

- For more detailed information please refer to load binder warnings and information section of this catalogue

CARGO CONTROL PRODUCTS

GRADE 70 TRANSPORT CHAIN

- Heat treated, high tensile carbon steel
- Commonly used as a binder tie down chain, meeting the stringent Department of Transportation requirements
- Design factor 4:1 (in accordance with NACM specifications)
- Proof loaded at 2x the WLL
- Permanently embossed with L7 or V7 every 6 links
- Gold Chromated finish



Chain Size	WLL (lbs)	Material Diameter	Inside Length	Inside Width	Weight (lbs/100')	Full drums		Vanguard Code*
						feet	lbs	
DOMESTIC - NORTH AMERICAN CHAIN								
1/4	3,150	0.275	1.240	0.460	74	800	592	3807 0016
5/16	4,700	0.330	1.150	0.490	100	550	550	3807 0020
3/8	6,600	0.397	1.300	0.600	145	400	580	3807 0024
7/16	8,750	0.458	1.370	0.670	209	300	627	3807 0028
1/2	11,300	0.520	1.560	0.810	264	200	528	3807 0032
IMPORTED CHAIN								
1/4	3,150	0.275	1.240	0.460	74	800	592	3807 1016
5/16	4,700	0.330	1.150	0.490	100	550	550	3807 1020
3/8	6,600	0.397	1.300	0.600	145	400	580	3807 1024
7/16	8,750	0.458	1.370	0.670	209	300	627	3807 1028
1/2	11,300	0.520	1.560	0.810	264	200	528	3807 1032

*For 1/2 drums, add '1' at the end of part number (i.e. 3807 00161)

** For NACM Specification see chart in the chain section of this catalogue

TAGS FOR GRADE 70 CHAIN AND ASSEMBLIES

- Steel tags with slit that can be opened and closed around chain link
- Stamped with chain diameter and Working Load Limit (WLL), provides easy visual confirmation of NSC Standard 10 requirements
- Yellow chromate finish



Diameter (inches)	Vanguard Code
1/4	3963 0016
5/16	3963 0020
3/8	3963 0024
1/2	3963 0032

Warning:

NEVER EXCEED WORKING LOAD LIMITS!

- NEVER use grade 70 chains for lifting applications

18" CHAIN TAILS - GRADE 70

- Design factor 3:1

Chain Size	WLL (lbs)	Model / Web Width	Weight (lbs)	Vanguard Code
5/16	3,335	S-925 / 2"	2.62	3705 4010
3/8	6,000	S-926 / 3"	3.50	3705 4011
3/8	6,600	S-927 / 4"	3.66	3705 4012
5/16	5,500	S-928 / 3"	2.80	3705 5000



GRADE 70 TIE DOWN ASSEMBLIES

- Designed for use in cargo securement, towing and logging.
- Grade 70 chain with alloy clevis grab hooks on each end.
- Manufactured in accordance with the Department of Transportation regulations
- Each assembly has a rating tags attached to meet NSC Standard 10 requirements
- Yellow chromate finish
- Design factor 4:1

Chain Diameter (inches)	WLL (lbs)	Weight (lbs/pc)	Vanguard Code
5/16 x 16'	4,700	16.00	3807 2016
5/16 x 20'	4,700	20.00	3807 2020
5/16 x 25'	4,700	25.00	3807 2025
3/8 x 16'	6,600	25.00	3807 2416
3/8 x 20'	6,600	31.00	3807 2420
3/8 x 25'	6,600	38.00	3807 2525



'AG'-TYPE GRADE 70 CLEVIS GRAB HOOKS

- Yellow chromate finish
- Latch included
- Also available in carbon steel

Size	Dimensions (inches)					WLL (lbs)	Weight (lbs)	Vanguard Code
	B	E	R	P	T			
1/4	9.0	10.0	50.0	9.6	10.0	3,600	0.62	3931 00161
5/16	10.0	11.0	57.4	11.0	12.5	5,400	0.95	3931 00201
3/8	12.0	12.7	66.8	12.0	10.5	7,500	1.28	3931 00241
1/2	19.1	16.8	81.0	16.0	17.8	12,750	2.60	3931 00321

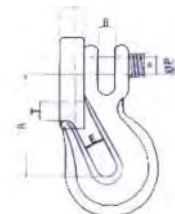

Warning:

NEVER EXCEED WORKING LOAD LIMITS!

- NEVER use grade 70 chains for lifting applications

CARGO CONTROL PRODUCTS

'BLACK PIN'® CLEVIS SLIP HOOKS - ALLOY STEEL

- For use with Grade 70 or lower grade chains only
- Gold Chromated body with 'black pin'
- Available with or without latches

Size	WLL (lbs)	Dimensions (inches)				Weight (lbs)	Vanguard Code*
		A	B	C	D		
1/4	2,750	0.43	0.38	0.98	2.52	0.65	3903 1016
5/16	4,300	0.51	0.43	1.10	2.82	0.92	3903 1020
3/8	5,250	0.58	0.47	1.33	3.22	1.32	3903 1024
7/16	7,000	0.67	0.54	1.61	3.69	2.07	3903 1028
1/2	9,000	0.76	0.62	1.74	3.99	2.90	3903 1032

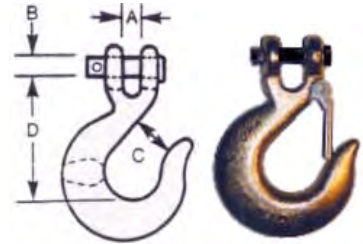

*For clevis slip hooks with latches, add '1' at the end of part number (i.e. 3903 10161)

'BLACK PIN'® CLEVIS GRAB HOOKS - ALLOY STEEL

- For use with Grade 70 or lower grade chains only
- Gold Chromated body with 'black pin'

Size	WLL (lbs)	Dimensions (inches)				Weight (lbs)	Vanguard Code
		A	B	C	D		
1/4	3,150	0.36	0.38	0.39	1.97	0.46	3931 0016
5/16	4,700	0.38	0.44	0.43	2.28	0.75	3931 0020
3/8	6,600	0.47	0.47	0.50	2.61	1.10	3931 0024
7/16	8,800	0.67	0.55	0.58	2.79	1.53	3931 0028
1/2	11,300	0.76	0.62	0.67	3.13	2.34	3931 0032

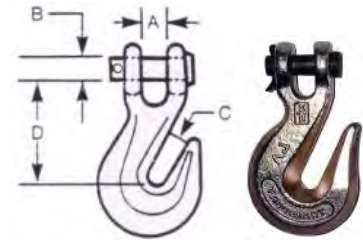

Note:

- Forged Carbon or Alloy Steel, heat treated
- Design Factor 4:1
- Refer to specific applications and warnings!

Warning:

NEVER EXCEED WORKING LOAD LIMITS!

- NEVER use grade 40 or 70 chains for overhead lifting applications
- ALWAYS discard hooks which show signs of deformation or excessive wear!

RATCHET BUCKLES

- Sturdy construction
- Double gear and pawl design offers increased reliability and safety
- We offer a wide range of handle widths and lengths
- Gold chromated finish
- Design factor 3:1

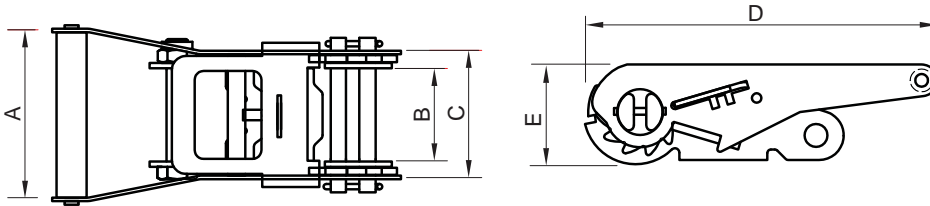

Web Width (inches)	WLL (lbs)	Dimensions (inches)					Vanguard Code
		A	B	C	D	E	
1	1,000	2.50	1.38	2.13	5.13	1.56	3701 1002
1	1,000	2.36	1.10	2.17	5.16	1.57	3701 1003
2	1,460	2.53	1.18	2.20	5.23	1.56	3701 1006
2	1,460	3.27	2.05	3.15	5.28	1.56	3701 2008
2	3,660	3.04	2.08	3.36	6.74	2.16	3701 2004
2	3,660	3.98	2.05	3.54	7.76	2.24	3701 2006
2	3,660	3.98	2.05	3.54	9.06	2.24	3701 2011
3	7,300	4.33	3.07	5.56	12.80	2.95	3701 3001
4	8,000	5.56	4.06	6.50	12.98	4.06	3701 4024

* Additional sizes, capacities and finishes available upon request, minimum order quantities may apply

Note:

- Working load limits (WLL) are for straight in-line pulls ONLY
- To increase the service life of strap assemblies the use of edge and corner protectors is strongly recommended

Warning:

NEVER EXCEED WORKING LOAD LIMIT!

Failure to follow instructions can result in serious property damage, injury or death!

- **NEVER** use handle extension or extension bars
- **NEVER** use strap assemblies where the straps are cut, frayed or otherwise damaged
- **ALWAYS** remember that strap assemblies/systems are only as strong as their weakest components
- **ALWAYS** make sure the webbing is wrapped 2-3 time around the reel **BEFORE** tightening
- **ALWAYS** make sure the total mass/weight of the load shall not exceed the aggregate working load limit of all tie-downs in use
- **ALWAYS** keep ratchet buckles clean and properly lubricated

OVERCENTRE BUCKLES

- Sturdy construction for additional tension on straps
- Gold dye-chromated finish or chrome-nickel stainless steel
- Low wear to strap
- Positive locking features
- Design factor 3:1

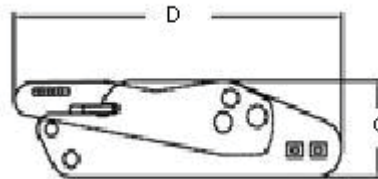

Finish	Web Width (inches)	WLL (lbs)	Dimensions (inches)				Vanguard Code
			A	B	C	D	
GOLD DYE-CHROMATE	2.00	1,860	2.44	2.00	1.00	5.51	3701 4020
STAINLESS STEEL	2.00	1,100	2.36	2.00	0.88	6.14	3701 4050
GOLD DYE-CHROMATE	1.75	1,860	2.52	1.81	1.63	6.69	3701 40201

Note:

- Working load limits (WLL) are for straight in-line pulls ONLY
- To increase the service life of strap assemblies the use of edge and corner protectors is strongly recommended

Warning:

NEVER EXCEED WORKING LOAD LIMIT!

Failure to follow instructions can result in serious property damage, injury or death!

- **NEVER** use handle extension or extension bars
- **NEVER** use strap assemblies where the straps are cut, frayed or otherwise damaged
- **ALWAYS** remember that strap assemblies/systems are only as strong as their weakest components
- **ALWAYS** make sure the webbing is wrapped 2-3 time around the reel **BEFORE** tightening
- **ALWAYS** make sure the total mass/weight of the load shall not exceed the aggregate working load limit of all tie-downs in use
- **ALWAYS** keep overcentre buckles clean and properly lubricated

CAM BUCKLES

- Cam buckles for easy and quick tying down of loads
- Die-cast, solid construction
- Large model with steel base
- For 1" and 2" wide straps
- Design factor 3:1

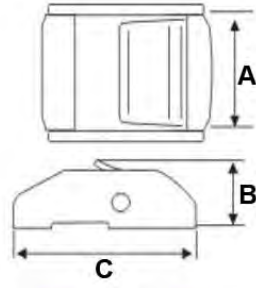

WLL (lbs)	Web Width (inches)	Dimensions (inches)			Vanguard Code
		A	B	C	
200	1.00	1.18	0.47	1.73	3701 5002
230	1.00	1.28	0.60	1.95	3701 5000
660	2.00	2.40	0.94	3.07	3701 5001

Note:

- Working load limits (WLL) are for straight in-line pulls ONLY
- To increase the service life of strap assemblies the use of edge and corner protectors is strongly recommended

Warning:

NEVER EXCEED WORKING LOAD LIMIT!

Failure to follow instructions can result in serious property damage, injury or death!

- **NEVER** use handle extension or extension bars
- **NEVER** use strap assemblies where the straps are cut, frayed or otherwise damaged
- **ALWAYS** remember that strap assemblies/systems are only as strong as their weakest components
- **ALWAYS** make sure the total mass/weight of the load shall not exceed the aggregate working load limit of all tie-downs in use
- **ALWAYS** keep cam buckles clean and properly lubricated

CARGO CONTROL PRODUCTS

CLOSED HOOKS

- Closed wire hooks are available in a variety of sizes and styles
- Yellow chromated finish
- Design factor 3:1

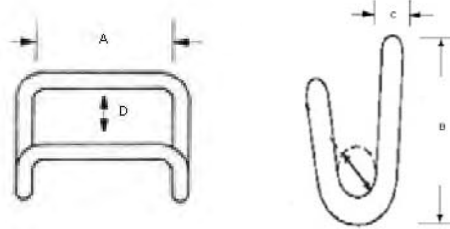

Web Width (inches)	WLL (lbs)	Dimensions (inches)				Vanguard Code
		A	B	C	D	
2	1,000	2.250	1.000	0.375	0.940	3703 0203

* Additional sizes, capacities and finishes available upon request, minimum order quantities may apply

VINYL COVERED HOOKS

- Strong S-hook coated with black vinyl
- For use where hooks are touching delicate surfaces
- Design factor 3:1

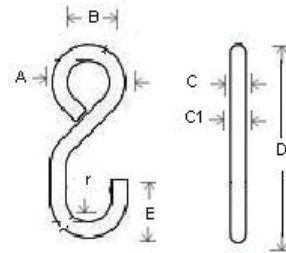

Web Width (inches)	WLL (lbs)	Dimensions 00(inches)							Vanguard Code
		A	B	C	C1	D	E	r	
1	600	1.687	0.937	0.312	0.375	4.125	1.500	0.375	3703 0018
2	830	2.000	0.937	0.437	0.500	5.000	2.000	0.500	3703 0019

* Additional sizes, capacities and finishes available upon request, minimum order quantities may apply

Note:

- Working load limits (WLL) are for straight in-line pulls ONLY

Warning:

NEVER EXCEED WORKING LOAD LIMIT!

Failure to follow instructions can result in serious property damage, injury or death!

- **NEVER** use strap assemblies where the straps are cut, frayed or otherwise damaged
- **ALWAYS** remember that strap assemblies/systems are only as strong as their weakest components
- **ALWAYS** make sure the total mass/weight of the load shall not exceed the aggregate working load limit of all tie-downs in use
- **ALWAYS** keep buckles clean and lubricated

FLAT HOOKS

- Flat hooks are available in a variety of sizes and styles
- Yellow chromate finish
- Design factor 3:1

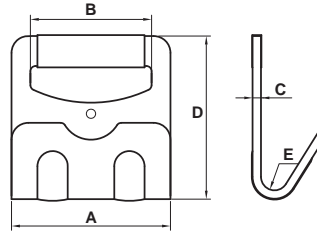

Web Width (inches)	WLL (lbs)	Dimensions (inches)					Vanguard Code
		A	B	C	D	E	
2	3,335	2.656	1.929	0.192	3.778	0.638	3703 0015
3 - 4	5,000	3.768	2.788	0.196	3.814	0.722	3703 0005

* Additional sizes, capacities and finishes available upon request, minimum order quantities may apply

NARROW WIRE HOOKS

- Narrow wire hooks are available in a variety of sizes and styles
- Yellow chromate finish
- Design factor 3:1

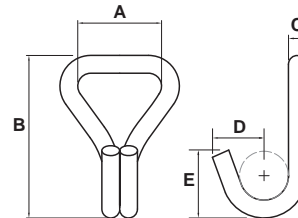

Web Width (inches)	WLL (lbs)	Dimensions (inches)					Vanguard Code
		A	B	C	D	E	
1	800	1.062	2.375	0.250	1.00	1.250	3703 0006
2	1,660	2.000	3.250	0.312	1.062	1.312	3703 0009
2	3,660	2.000	3.250	0.500	1.187	1.321	3703 0008

* Additional sizes, capacities and finishes available upon request, minimum order quantities may apply

Note:

- Working load limits (WLL) are for straight in-line pulls ONLY

Warning:

NEVER EXCEED WORKING LOAD LIMIT!

Failure to follow instructions can result in serious property damage, injury or death!

- **NEVER** use strap assemblies where the straps are cut, frayed or otherwise damaged
- **ALWAYS** remember that strap assemblies/systems are only as strong as their weakest components
- **ALWAYS** make sure the total mass/weight of the load shall not exceed the aggregate working load limit of all tie-downs in use
- **ALWAYS** keep buckles clean and lubricated

STANDARD SLIDING WINCHES

- Sturdy construction
- Extra strong ratchet pawl
- Design factor 3:1
- The WLL is permanently marked on each winch
- Sliding winches allow for easy positioning in the track, however once tension is applied they will lock into place
- Bolt on type winches, can be welded for fixed applications, this must only be performed by a competent/qualified welder. For best results use Bonarc® 7018 mild steel electrodes or Bonarc® ER70S-6 wire
- For use with 4" straps
- Unless otherwise stated all Vanguard winches shown are right hand models, left hand models are only available as a special order

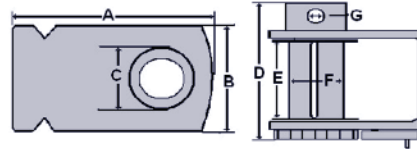
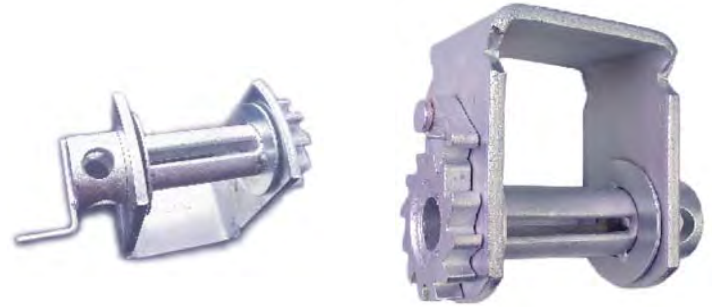

Type	WLL (lbs)	Dimensions (inches)							Vanguard Code
		A	B	C	D	E	F	G	
With flange (painted black)	6,000	6.75	3.92	2.25	7.75	4.30	1.90	0.93	3705 1020
Without flange	6,000	6.75	4.00	2.50	8.25	4.50	1.75	1.00	3705 1021
With flange & handle	6,000	6.75	4.00	2.50	8.25	4.50	1.75	1.00	3705 1063
With handle, NO flange	6,000	6.75	4.00	2.50	8.25	4.50	1.75	1.00	3705 1065

* Additional sizes, capacities and finishes available upon request, minimum order quantities may apply

Note:

- **Always** perform a thorough inspection of each winch before use to ensure that the units are not damaged and they are in good working order
- Damaged/malfunctioning winches should be removed from use until repaired by a competent properly trained person. If the units cannot be repaired they should be disposed of and replaced with new units
- Winches should be periodically cleaned to remove any dirt, mud, stones, road salt or ice that may have accumulated
- Winches should be lubricated periodically to ensure a long and reliable service life
- Both the winch cleaning and lubricating frequency will vary based upon the working conditions of the units, it is the responsibility of the user to determine the proper frequency

Warning:

NEVER EXCEED WORKING LOAD LIMIT!

Failure to follow instructions can result in serious property damage, injury or death!

- **NEVER** use handle extension or extension bars
- **NEVER** use straps that are cut, frayed or otherwise damaged
- **NEVER** release the winch bar without first ensuring that the ratchet pawls are properly engaged
- **ALWAYS** make sure that the webbing is inserted a minimum of 12" into the slot on the mandrel and that it is wrapped 2-3 times around the mandrel before tightening
- **ALWAYS** ensure that you have a firm grip on the winch bar when in use to avoid the risk of injury

2" LASHING WINCH

- Sturdy construction
- Base painted black, moving parts yellow chromated
- Working load limit 3,660 lbs
- Extra strong ratchet pawl
- Bolt-on type

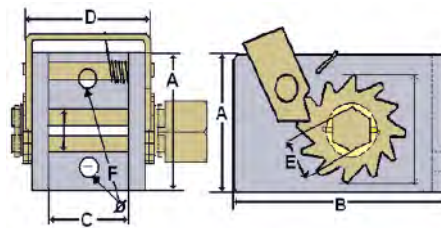

Type	WLL (lbs)	Dimensions (inches)						Vanguard Code
		A	B	C	D	E	F	
Hex Key, Two Hole	3,660	3.00	4.00	2.19	3.25	1.06	0.50	3705 1000
Hex Key, One Hole	3,660	3.00	4.50	2.05	3.18	1.10	0.75	3705 10009
One Hole (Yellow)	3,660	2.95	4.80	2.10	2.57	1.10	0.70	3705 1032

* Additional sizes, capacities and finishes available upon request, minimum order quantities may apply

Note:

- **Always** perform a thorough inspection of each winch before use to ensure that the units are not damaged and they are in good working order
- Damaged/malfunctioning winches should be removed from use until repaired by a competent properly trained person. If the units cannot be repaired they should be disposed of and replaced with new units
- Winches should be periodically cleaned to remove any dirt, mud, stones, road salt or ice that may have accumulated
- Winches should be lubricated periodically to ensure a long and reliable service life
- Both the winch cleaning and lubricating frequency will vary based upon the working conditions of the units, it is the responsibility of the user to determine the proper frequency

Warning:

NEVER EXCEED WORKING LOAD LIMIT!

Failure to follow instructions can result in serious property damage, injury or death!

- **NEVER** use handle extension or extension bars
- **NEVER** use straps that are cut, frayed or otherwise damaged
- **NEVER** release the winch bar without first ensuring that the ratchet pawls are properly engaged
- **ALWAYS** make sure that the webbing is inserted a minimum of 12" into the slot on the mandrel and that it is wrapped 2-3 times around the mandrel before tightening
- **ALWAYS** ensure that you have a firm grip on the winch bar when in use to avoid the risk of injury

RATCHET GEAR HAND WINCH

- Solid gear construction
- Internally lubricated drum and pinion gear bushings
- Molded and smoothly rotating handle
- Formed reinforcements in frame for added strength
- Zinc plated finish
- Holds load when handle is released
- Operating instructions included with each unit
- Handle and nut must be tightened against drive shaft before operating winch
- Winch cable sold separately



Description	Model Number	Gear Ratio	Capacity (lbs)	Vanguard Code
Ratchet 1 way	US-01	3.2:1	600	3851 0600
Ratchet 1 way	US-02	3.2:1	800	3851 0800
Ratchet 1 way and Free Spool	US-03	4.1:1	1,000	3851 1000
Ratchet 1 way and Free Spool	US-04	4.1:1	1,200	3851 1200
Ratchet 1 way and Free Spool	US-05	4.1:1	1,400	3851 1400
Ratchet 2 way and Free Spool	US-08	4.1:1	1,600	3851 1600
Ratchet 2 way and Free Spool (dual gear)	US-06	4.1:1 & 9.8:1	2,000	3851 2000
Ratchet 2 way and Free Spool (dual gear)	US-07	5:1 & 12:1	2,500	3851 2500

* Not a standard stock item at all distribution centres.

** Additional styles and capacity units available upon request, minimum order quantities may apply

WORM GEAR HAND WINCH

- Solid gear construction
- Internally lubricated drum and pinion gear bushings
- Loop drive without handle
- Formed reinforcements in frame for added strength
- Black finish
- Reel automatically stops turning whenever cranking is stopped, locking load in place
- Operating instructions included with each unit
- Loop drive must be tightened against drive shaft before operating winch
- Winch cable sold separately



Description	Model Number	Gear Ratio	Capacity (lbs)	Vanguard Code
Ratchet 2 way	620AB	4.1:1	2,000	3851 2001

* Not a standard stock item at all distribution centres.

** Additional styles and capacity units available upon request, minimum order quantities may apply

Warning:

NEVER EXCEED WORKING LOAD LIMIT!

Failure to follow instructions can result in serious property damage, injury or death!

- **NEVER** use a hand winches to lift, support, transport people or loads over areas where people could be present
- **ALWAYS** inspect winches before use to make sure that they are in proper working order. Do not use if damaged, send immediate for repair by a properly trained qualified/competent person before returning to service.

WINCH BARS

- Standard winch bars in either black painted or attractive chrome plated finish
- No-slip handle and nose surface for better grip

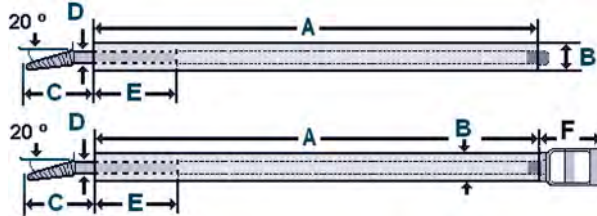

Type	Dimensions (inches)						Vanguard Code
	A	B	C	D	E	F	
Standard Black	32.68	1.26	3.35	0.93	9.84	-	3703 0060
Standard Chrome	32.68	1.26	3.35	0.93	9.84	-	3703 0063
Combination Bar Chrome	31.50	1.26	3.19	0.99	10.24	5.31	3703 0061
Combination Bar Black	31.50	1.26	3.19	0.99	10.24	5.31	3703 0062

Warning:

- **ALWAYS** hold winch bars firmly when tightening or loosening straps
- **BEFORE** removing winch bars ensure that ratchet pawl is fully engaged
- **NEVER** use extension bars with winch bars
- **WHEN** tightening or loosening straps make sure that nose of winch bar is fully inserted into holes of winch drums
- **KEEP** bystanders in safe distance when tightening or loosening straps

CORNER PROTECTORS FOR CHAIN & WEBBING

- Available in galvanized steel or white plastic (for webbing)
- Prolongs service life of webbing
- Protects cargo from chains or webbing

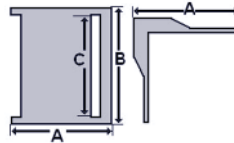

Type	Dimensions (inches)			Vanguard Code
	A	B	C	
Plastic Corner Protector for 2 - 4" Webbing	4.3	5.3	4.1	3703 0048
2" Steel Corner Protector for Chains	4.7	5.9	-	3703 0040
Steel Corner Protector for 3" Webbing	4.3	6.5	-	3703 0043
Steel Corner Protector for 4" Webbing	4.3	7.5	-	3703 0045

Warning:

- **NEVER** use plastic corner protectors for chains
- **ALWAYS** make sure that webbing or chains slide properly over corner protectors

D-RINGS WITH WELD-ON HINGES

- Made from drop forged carbon steel, quenched & tempered
- Self coloured, ready to be welded on truck body
- Hinges are bevelled 35° for proper weld penetration
- This must be performed by a qualified welder. For best welding results use BONARC E 7018 coated welding electrodes or BONARC ER 70S-6 welding wire
- Before welding, make sure that all contaminants like rust, oil, paint, and galvanization are removed from welding area
- Design factor 3:1

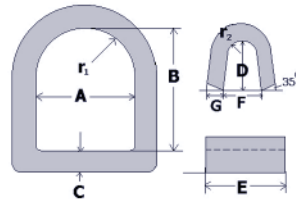

Size	WLL (lbs)	Dimensions (inches)									Vanguard Code
		A	B	C	D	E	F	G	r ¹	r ²	
3 x 3 x 5/8"	6,000	3.00	3.00	0.63	0.88	2.50	1.00	0.38	1.50	0.38	3705 0015
3 x 4 x 1"	12,000	3.00	4.00	1.00	1.33	2.56	1.31	0.50	1.50	0.56	3705 0014

* Additional sizes available upon request, minimum order quantities may apply

Note:

- Working load limits (WLL) are for straight in-line pulls ONLY
- Bolt on D-Rings are the perfect choice when a permanent (weld-on) lashing point is undesirable, or in the case where the surface is not suitable for welding the hinge on in a safe and secure manner

Warning:

- NEVER EXCEED WORKING LOAD LIMIT!**
Failure to follow instructions can result in serious property damage, injury or death!
- **ALWAYS** make sure to use bolts of adequate size and strength
 - **ALWAYS** use washers and lock washers when securing the bolt-on hinges, making sure to torque tighten the bolts
 - **ALWAYS** inspect the condition of the hinges before securing a load, damaged hinges should be removed and replaced with new hinges by a competent/properly trained person
 - **PERIODIC** adjustments may be required and it is the responsibility of the end-user to make sure that his maintenance is performed at regular intervals



TARP TIE-DOWN STRAPS

- VANGUARD branded straps available either in 100% natural rubber (black) or synthetic EPDM (artic-blue)
- With UV and Ozone inhibitor for better resistance against cracking
- For conditions with extreme atmospheric Ozone levels (high pollution in temperatures between -2° and +3° C we recommend EPDM straps with increased resistance against corrosion)
- Elastic stretch to 150% of nominal length
- Rubber only: VGD & 50lb WLL marking



Type	Dimensions (inches)		Vanguard Code
	Length	Max. Stretch	
100% Natural Rubber (Black)	4	6	3708 0004
100% Natural Rubber (Black)	9	14	3708 0009
100% Natural Rubber (Black)	15	23	3708 0015
100% Natural Rubber (Black)	21	32	3708 0021
100% Natural Rubber (Black)	31	47	3708 0031
100% Natural Rubber (Black)	41	62	3708 0041
Artic Blue EPDM	9	14	3708 1009
Artic Blue EPDM	15	23	3708 1015
Artic Blue EPDM	21	32	3708 1021
Artic Blue EPDM	31	47	3708 1031

CHROME PLATED HITCH BALLS

- Drop forged low carbon steel
- Complete with hex nut and washer
- UNC threads
- 'V 5', WLL and size markings

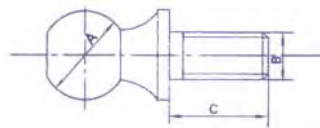

Ball Diameter (A)	WLL (lbs)	Dimensions (inches)			MBS (lbs)	Weight (lbs)	Vanguard Code
		Shank (B)	Shank Length (C)	Thread Size			
1-7/8	3,500	0.75	2.00	16	10,500	1.70	3990 1048
2	3,500	0.75	2.00	16	10,500	2.00	3990 2048
2	5,000	1.00	2.00	14	15,000	2.50	3990 2100
2-15/16	5,000	1.00	2.00	14	15,000	3.20	3990 3100
2-15/16	7,500	1.25	2.00	12	22,500	3.80	3990 3116

Warning:

- **TYING** tarp straps over sharp edges shortens the service life
- **NEVER** tie knots in tarp straps
- **NEVER** extend over safe stretch (150%)
- **ALWAYS** inspect straps frequently, replace cracked straps

MATERIAL HANDLING



VANGUARD STEEL LTD.

VQ SUPER SERIES MANUAL LEVER HOISTS

- Compact and extremely light weight
- Fully machined lifting wheels
- Optimal gear ratio
- Unique hand wheel & knob design-No preload required
- Needle Roller bearing
- Weston Style Dual Pawl Brake System - Double pawl design increases safety
- Fused Brake Disc (ratchet disc and friction plate/discs are fused together)
- Grade 100 Heat treated load chain with dichromate finish
- Steel handles with rubber hand grip providing greater operator comfort and control
- Self-articulating top hooks
- Extra-large forged alloy top and bottom hooks (with cast latches) rotate 360°
- Top and bottom hooks are designed to stretch when overloaded before chain failure
- Each hoist is proof tested at 1.5 times the rated capacity, certificate provided
- Durable baked enamel paint protection
- Meet ASME B30.21 safety standards
- ISO 9001 – 2001 certified factory
- Custom length units available upon request

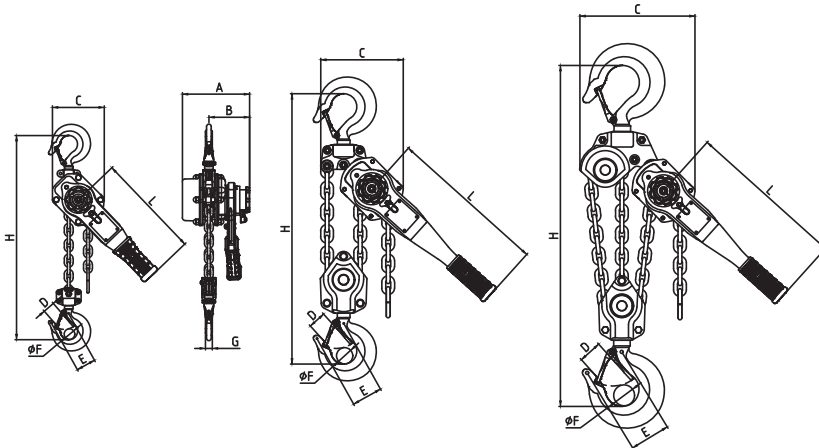

0.8 - 3.2t

6.3t

9t



Model	VQ08	VQ1	VQ16	VQ32	VQ63	VQ9
Capacity Metric Tons (t)	0.8	1.0	1.6	3.2	6.3	9.0
Proof Load (t)	1.2	1.5	2.4			
Effort (maximum lift) (N)						
No. of falls, load chain	1	1	1	1	2	3
Load Chain (mm)	5.6 x 15.7	5.6 x 15.7	7.1 x 19.9	10 x 2.8	10 x 2.8	10 x 2.8
Dimensions (mm)	A	146	146	164	196	196
	B	119	119	126	159	218
	C	41.5	49.4	52.0	61.9	84.3
	D	280	300	335	395	540
	E	245	245	265	415	415
	F	96	96	100	114	114
	G	26.5	31.5	35.5	43.0	53.0
	H	35.5	42.5	42.5	50.0	60.0
	I	14.0	15.0	19.0	24.5	34.0

MATERIAL HANDLING

VQ SUPER SERIES MANUAL LEVER HOISTS

Model	Capacity Metric Ton (t)	Lift (ft)	Capacity (lbs)	Load Chain (mm)	Weight (lbs)	Vanguard Code
VQ08	0.8	w/o	1,750	5.6 x 15.7	10.75	3855 30008
VQ08X5	0.8	5	1,750	5.6 x 15.7	12.56	3855 30508
VQ08X10	0.8	10	1,750	5.6 x 15.7	15.41	3855 31008
VQ1	1.0	w/o	2,000	5.6 x 15.7	11.20	3855 30010
VQ1X5	1.0	5	2,000	5.6 x 15.7	13.00	3855 30510
VQ1X10	1.0	10	2,000	5.6 x 15.7	15.85	3855 31010
VQ16	1.6	w/o	3,500	7.1 x 19.9	14.00	3855 30016
VQ16X5	1.6	5	3,500	7.1 x 19.9	17.63	3855 30516
VQ16X10	1.6	10	3,500	7.1 x 19.9	22.26	3855 31016
VQ32	3.2	w/o	7,000	10 x 2.8	22.70	3855 30032
VQ32X5	3.2	5	7,000	10 x 2.8	29.98	3855 30532
VQ32X10	3.2	10	7,000	10 x 2.8	37.25	3855 31032
VQ63	6.3	w/o	13,000	10 x 2.8	49.95	-
VQ63X5	6.3	5	13,000	10 x 2.8	57.32	-
VQ63X10	6.3	10	13,000	10 x 2.8	64.59	-
VQ90	9.0	w/o	19,000	10 x 2.8	80.82	-
VQ90X5	9.0	5	19,000	10 x 2.8	88.18	-
VQ90X10	9.0	10	19,000	10 x 2.8	95.45	-



* VQ63 and VQ9 are not standard stock items

PARTS FOR VQ SUPER SERIES MANUAL LEVER HOISTS

Capacity Metric Tons (t)		0.8	1.0	1.6	3.2
Load Chain	Dimensions (mm)	5.6 x 15.7	5.6 x 15.7	7.1 x 19.9	10 x 2.8
	Vanguard Code	3858 30515	3858 30515	3858 30719	3858 31028
	Weight (lbs/ft)	0.53	0.53	0.74	1.48
Overload Device		3855 32808	3855 32808	3855 32816	3855 32832
Top Hook Assy*		3855 35008	3855 35010	3855 35016	3855 35032
Bottom Hook Assy*		3855 36008	3855 36010	3855 36016	3855 36032
Ratchet Disc w/Fused Friction Discs		3855 37008	3855 37010	3855 37016	3855 37032
Latch Kit		3855 38008	3855 38008	3855 38016	3855 38032
Overload Name Plate with Rivets		3855 39108	3855 39110	3855 39116	3855 39132

* Top and Bottom Hooks come complete with latch kits

Warning:

NEVER EXCEED WORKING LOAD LIMITS!

FAILURE TO OBSERVE these warnings may result in serious injury or death!

- **ALWAYS** inspect all components frequently for signs of wear or damage
- **ALWAYS** keep load chains lubricated

SUPER DUTY MANUAL LEVER HOISTS

- Compact design
- Light weight robust construction
- Fully machined lifting wheels
- Optimal gear ratio
- Closed sealed bearings
- Extra heavy double pawl braking mechanism
- Extra thick friction discs (asbestos free)
- Grade 80 alloy load chain
- Steel handles with rubber hand grip providing greater operator comfort and control
- Self-articulating top hooks
- Extra large forged alloy top and bottom hooks (with cast latches) rotate 360°
- Top and bottom hooks are designed to stretch when overloaded before chain failure
- Each hoist is proof tested at 1.5 times the rated capacity, certificate provided with each hoist
- All units except 1/4t come with overload protection installed
- Durable baked enamel paint protection
- Meet ASME B30.21 safety standards
- ISO 9001 – 2001 certified factory
- Custom length units available upon request

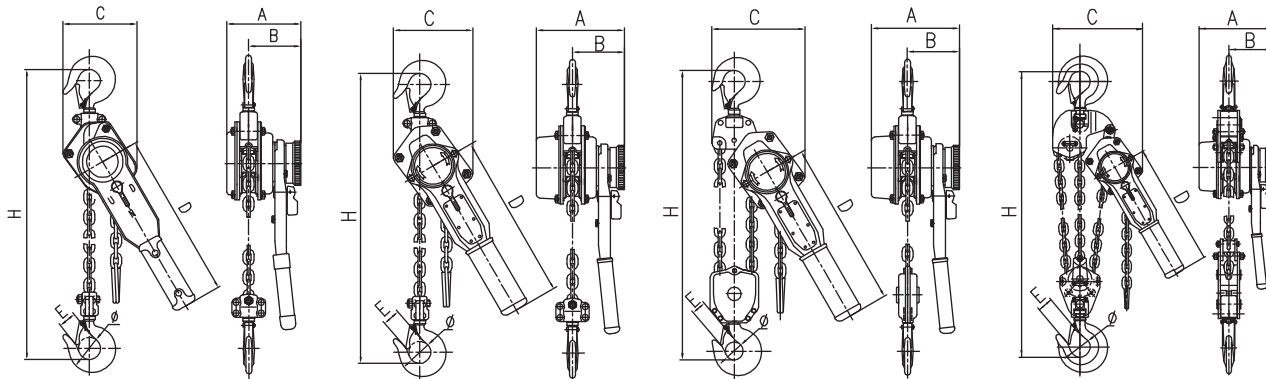

1/4t

1/2t to 3t

6t

9t

Capacity Metric Tons (t)	1/4*	1/2	3/4	1-1/2	3	6	9
Proof Load (kN)	3.70	7.50	11.25	22.00	45.00	90.00	135.00
Effort (maximum lift) (N)	282	248	265	295	335	370	420
No. of falls, load chain	1	1	1	1	1	2	3
Load Chain (mm)	4 x 12	5 x 15	6 x 18	7 x 21	10 x 30	10 x 30	10 x 30
Dimensions (mm)	A	92	143	148	173	200	200
	B	71	86	87	99	112	112
	C	70	118	132	145	199	230
	D	168	253	278	378	418	418
	E	19	23.5	25.5	31	36	37
	H	245	300	330	400	520	640
	∅	31	31.5	35.5	42.5	50	53

* 1/4T unit does not have overload protection

** 9T unit is not a standard stock item

MATERIAL HANDLING

SUPER DUTY LEVER HOISTS

Hoist No.	Tonnage Rating	Lift	Capacity (lbs)	Load Chain	Weight (lbs)	Vanguard Code
VLHP 14x5	1/4	5	500	4x12	4.4	3855 0502E
VLHP 14x10	1/4	10	500	4x12	7.7	3855 1002E
VLHP 12	1/2	w/o	1,000	5x12	9.9	3855 0005E
VLHP 12x5	1/2	5	1,000	5x15	11.0	3855 0505E
VLHP 12x10	1/2	10	1,000	5x15	13.2	3855 1005E
VLHP 34	3/4	w/o	1,500	6x18	11.0	3855 0007E
VLHP 34x5	3/4	5	1,500	6x18	14.3	3855 0507E
VLHP 34x10	3/4	10	1,500	6x18	17.6	3855 1007E
VLHP 112	1-1/2	w/o	3,000	7x21	18.7	3855 0015E
VLHP 112x5	1-1/2	5	3,000	7x21	23.1	3855 0515E
VLHP 112x10	1-1/2	10	3,000	7x21	26.4	3855 1015E
VLHP 3	3	w/o	6,000	10x30	34.1	3855 0030E
VLHP 3x5	3	5	6,000	10x30	44.0	3855 0530E
VLHP 3x10	3	10	6,000	10x30	55.0	3855 1030E
VLHP 6	6	w/o	12,000	10x30	46.2	3855 0060E
VLHP 6x5	6	5	12,000	10x30	66.0	3855 0560E
VLHP 6x10	6	10	12,000	10x30	85.8	3855 1060E



Custom lengths available upon request

PARTS FOR SUPER DUTY LEVER HOISTS

Capacity Metric Tons (t)		1/4	1/2	3/4	1-1/2	3	6
Load Chain	Dimensions (mm)	4 x 12	5 x 15	6 x 18	7 x 21	10 x 30	10 x 30
	Part Number	3858 0412	3858 0515	3858 0618	3858 0824	3858 1030	3858 1030
	Weight (lbs/ft)	0.24	0.37	0.52	0.71	1.46	1.46
Bottom Hook Assembly*		3855 6002E	3855 6005E	3855 6007E	3855 6015E	3855 6030E	3855 6060E
Top Hook Assembly*		3855 5002E	3855 5005E	3855 5007E	3855 5015E	3855 5030E	3855 5060E
Cast Latch Kits		3855 98002E	3855 98005E	3855 98007E	3855 98015E	3855 98030E	3855 98060E
Friction Discs (asbestos free)			3855 7005E	3855 7007E	3855 7015E	3855 7030E	3855 7060E
Handle			3855 8005E	3855 8007E	3855 8015E	3855 8030E	3855 8060E
Square Cast Ring		3855 93002E	3855 93002E	3855 93002E	3855 93015E	3855 93030E	3855 93030E
Guide Plate				3855 90807E	3855 90815E	3855 90830E	3855 90830E
Name Plate				3855 92707E	3855 92715E	3855 92730E	3855 92760E

* Bottom and Top Hook Assemblies come complete with Cast Latches

Warning:

NEVER EXCEED WORKING LOAD LIMITS!

FAILURE TO OBSERVE these warnings may result in serious injury or death!

- **ALWAYS** inspect all components frequently for signs of wear or damage
- **ALWAYS** keep load chains lubricated

TYPE-1 HEAVY DUTY MANUAL LEVER HOISTS

- Compact design
- Light weight robust construction
- Fully machined lifting wheels
- Grade 80 alloy load chain
- Sealed bearings
- Triple spur geared, guarantees efficient/reliable operation
- Automatic brake engagement holds load at any desired height
- Double pawl braking mechanism
- Friction discs (asbestos free)
- Steel handles with rubber hand grip providing greater operator comfort and control
- Self-articulating top hooks
- Forged alloy top and bottom hooks (with latches) rotate 360°
- Top and bottom hooks are designed to stretch when overloaded before chain failure
- Each hoist is proof tested at 1.5 times the rated capacity, certificate is provided with each hoist
- Meet ASME B30.21 safety standards
- ISO 9001 – 2001 certified factory
- Custom length units available upon request

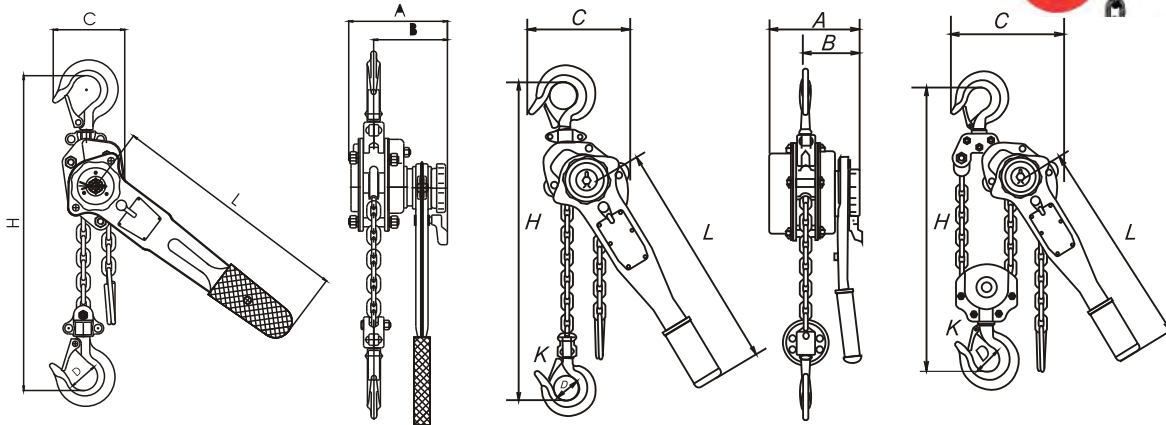

1/2t

3/4t to 3t

6t to 9t

Capacity Metric Tons (t)	1/2	3/4	1-1/2	3	6	9
Proof Load (kN)	6.30	11.00	22.10	44.10	88.20	132.30
Effort (maximum lift) (N)	340	140	220	320	340	360
No. of falls, load chain	1	1	1	1	2	3
Load Chain (mm)	5 x 15	6 x 18	8 x 24	10 x 30	10 x 30	10 x 30
Dimensions (mm)	A	105	145	175	203	203
	B	75	86	100	118	118
	C	80	122	130	150	205
	D	35	40	45	55	65
	H	260	320	380	480	620
	L	300	280	410	410	410
	K	30	26	30	38	44

MATERIAL HANDLING



TYPE-1 LEVER HOISTS

1/2 TO 1-1/2

Hoist No.	Tonnage Rating	Lift	Weight (lbs)	Vanguard Code
VLH 12	1/2	w/o	7.00	3855 0005
VLH 12x5	1/2	5	8.80	3855 0505
VLH 12x10	1/2	10	10.60	3855 1005
VLH 34	3/4	w/o	13.20	3855 0007
VLH 34x5	3/4	5	15.90	3855 0507
VLH 34x10	3/4	10	18.50	3855 1007
VLH 34x15	3/4	15	21.20	3855 1507
VLH 34x20	3/4	20	23.80	3855 2007
VLH 112	1-1/2	w/o	19.20	3855 0015
VLH 112x5	1-1/2	5	24.70	3855 0515
VLH 112x10	1-1/2	10	29.50	3855 1015
VLH 112x15	1-1/2	15	34.20	3855 1515
VLH 112x20	1-1/2	20	39.00	3855 2015

Custom lengths available upon request



3 TO 9

Hoist No.	Tonnage Rating	Lift	Weight (lbs)	Vanguard Code
VLH 3	3	w/o	37.50	3855 0030
VLH 3x5	3	5	46.30	3855 0530
VLH 3x10	3	10	53.60	3855 1030
VLH 3x15	3	15	60.90	3855 1530
VLH 3x20	3	20	68.40	3855 2030
VLH 6	6	w/o	50.70	3855 0060
VLH 6x5	6	5	68.40	3855 0560
VLH 6x10	6	10	82.90	3855 1060
VLH 6x15	6	15	97.50	3855 1560
VLH 6x20	6	20	111.80	3855 2060
VLH 9	9	w/o	81.57	3855 0090
VLH 9x5	9	5	103.62	3855 0590
VLH 9x10	9	10	125.00	3855 1090
VLH 9x15	9	15	146.61	3855 1590
VLH 9x20	9	20	167.99	3855 2090

PARTS FOR TYPE-1 LEVER HOISTS

Capacity Metric Tons (t)	1/2	3/4	1-1/2	3	6	9
Capacity (lbs)	1,100	1,650	3,300	6,300	13,200	19,800
Load Chain	Dimensions (mm)	5 x 15	6 x 18	8 x 24	10 x 30	10 x 30
	Part Number	3858 0515	3858 0618	3858 0824	3858 1030	3858 1030
	Weight (lbs/ft)	0.37	0.52	0.94	1.46	1.46
Bottom Hook Assembly*	3855 6005	3855 6007	3855 6015	3855 6030	3855 6060	3855 6090
Top Hook Assembly*		3855 5007	3855 5015	3855 5030	3855 5060	3855 5090
Latch Kits	3859 8005	3859 8007	3859 8015	3859 8030	3859 8060	3859 8090
Latch Kits for Integrated Hooks	3859 8205	3859 8207	3859 8215	3859 8230	3859 8260	
Friction Discs (asbestos free)	3859 7005	3859 7007	3859 7015	3859 7030	3859 7060	3859 7060
Handle	3855 8005	3855 8007	3855 8060	3855 8060	3855 8060	
Square Cast Ring		3855 93007	3855 93015	3855 93030	3855 93030	
Guide Plate		3855 907007	3855 907015	3855 90730	3859 07030	3859 07030
Name Plate	3855 9105	3855 9107	3855 9115	3855 9130	3855 9160	3855 9190
Rubber Grip		3855 961007		3855 961015	3855 961015	3855 961015

* Bottom and Top Hook Assemblies come complete with latches

Warning:

NEVER EXCEED WORKING LOAD LIMITS!

FAILURE TO OBSERVE these warnings may result in serious injury or death!

- ALWAYS inspect all components frequently for signs of wear or damage
- ALWAYS keep load chains lubricated

SUPER DUTY CHAIN HOISTS

- Compact design
- Light weight robust construction
- Overload protection
- Fully machined lifting wheels
- Optimal gear ratio
- Closed sealed bearings
- Triple spur geared guarantee efficient/reliable operation
- Automatic brake engagement holds load at any desired height
- Extra heavy double pawl braking mechanism
- Extra thick friction discs (asbestos free)
- Grade 80 alloy load chain
- Self-articulating top hooks
- Extra large forged alloy top and bottom hooks (with cast latches) rotate 360°
- Top and bottom hooks are designed to stretch when overloaded before chain failure
- Each hoist is proof tested at 1.5 times the rated capacity, certificate provided with each hoist
- Durable baked enamel paint protection
- Meet ASME B30.16 safety standards
- ISO 9001 – 2001 certified factory
- Custom length units available upon request

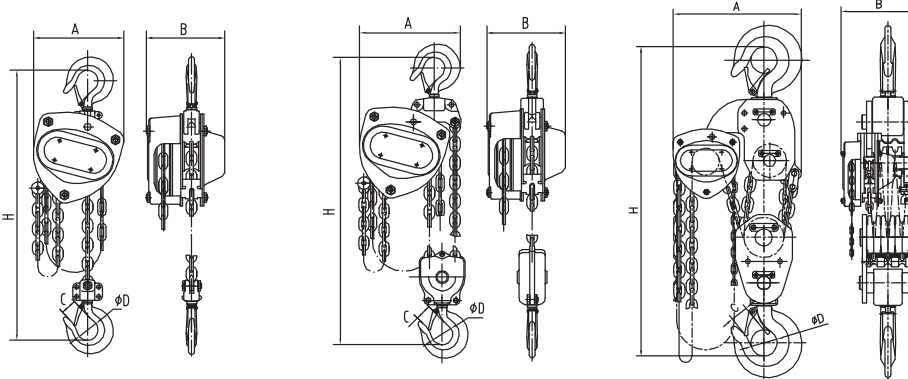

1/2t to 3t

5t

10t

Capacity Metric Tons (t)	1/2	1	1-1/2	2	3	5	10
Proof Load (kN)	7.35	14.70	22.05	29.40	44.10	73.50	122.50
Effort (maximum lift) (N)	240	250	265	335	372	360	380
No. of falls, load chain	1	1	1	1	1	2	4
Load Chain (mm)	5 x 15	6 x 18	7 x 21	8 x 24	10 x 30	10 x 30	10 x 30
Dimensions (mm)	A	148	172	196	210	255	463
	B	132	151	173	175	205	183
	C	23	26	29.5	34	37.5	41
	D	35	40	45	50	55	65
	H	345	376	442	470	580	690

*7-1/2T, 10T, 15T, 20T, and 25T are also available as a special order

MATERIAL HANDLING

SUPER DUTY CHAIN HOISTS

Hoist No.	Tonnage Rating	Lift	Capacity (lbs)	Load Chain	Weight (lbs)	Vanguard Code
VCHP 12	1/2	W/O	1,000	5x15	11.0	3850 0005E
VCHP 12x10	1/2	10	1,000	5x15	19.8	3850 1005E
VCHP 12x20	1/2	20	1,000	5x15	29.7	3850 2005E
VCHP 1	1	W/O	2,000	6x18	15.4	3850 0010E
VCHP 1x10	1	10	2,000	6x18	26.4	3850 1010E
VCHP 1x20	1	20	2,000	6x18	36.3	3850 2010E
VCHP 112	1-1/2	W/O	3,000	7x21	24.2	3850 0015E
VCHP 112x10	1-1/2	10	3,000	7x21	36.3	3850 1015E
VCHP 112x20	1-1/2	20	3,000	7x21	48.4	3850 2015E
VCHP 2	2	W/O	4,000	8x24	28.6	3850 0020E
VCHP 2x10	2	10	4,000	8x24	41.8	3850 1020E
VCHP 2x20	2	20	4,000	8x24	58.3	3850 2020E
VCHP 3	3	W/O	6,000	10x30	47.3	3850 0030E
VCHP 3x10	3	10	6,000	10x30	70.4	3850 1030E
VCHP 3x20	3	20	6,000	10x30	83.6	3850 2030E
VCHP 5	5	W/O	10,000	10x30	57.2	3850 0050E
VCHP 5x10	5	10	10,000	10x30	86.9	3850 1050E
VCHP 5x20	5	20	10,000	10x30	113.3	3850 2050E



... Custom length Chain Hoists available upon request

... 7 1/2T, 10T, 15T, 20T, and 25T chain hoists are also available as a special order from our factory

PARTS FOR SUPER DUTY CHAIN HOISTS

Capacity Metric Tons (t)		1/2	1	1-1/2	2	3	5
Load Chain	Dimensions (mm)	5 x 15	6 x 18	7 x 21	8 x 24	10 x 30	10 x 30
	Part Number	3858 0515	3858 0618	3858 0721	3858 0824	3858 1030	3858 1030
Bottom Hook Assembly*		3850 6005E	3850 6010E	3850 6015E	3850 6020E	3850 6030E	3850 6050E
Top Hook Assembly*		3850 5005E	3850 5010E	3850 5015E	3850 5020E	3850 5030E	3850 5050E
Latch Kits		3850 8005E	3850 8010E	3850 8015E	3850 8020E	3850 8030E	3850 8050E
Friction Discs (asbestos free)		3850 7005E	3850 7010E	3850 7015E	3850 7020E	3850 7030E	3850 7050E
Name Tag			3850 91610E	3850 91615E	3850 91620E	3850 91630E	3850 91650E
Chain Guide Roller			3850 93010E	3850 93015E	3850 93020E	3850 92030E	3850 93050E

* Bottom and Top Hook Assemblies come complete with latches

Warning:

NEVER EXCEED WORKING LOAD LIMITS!

FAILURE TO OBSERVE these warnings may result in serious injury or death!

- **ALWAYS** inspect all components frequently for signs of wear or damage
- **ALWAYS** keep load chains lubricated

TYPE-1 HEAVY DUTY MANUAL CHAIN HOISTS

- Compact design
- Light weight robust construction
- Fully machined lifting wheels
- Grade 80 alloy load chain
- Sealed bearings
- Triple spur geared guarantee efficient/reliable operation
- Automatic brake engagement holds load at any desired height
- Double pawl braking mechanism
- Asbestos free friction discs
- Self-articulating top hooks
- Forged alloy top and bottom hooks (with latches) rotate 360°
- Top and bottom hooks are designed to stretch when overloaded before chain failure
- Each hoist is proof tested at 1.5 times the rated capacity, certificate provided with each hoist
- Meet ASME B30.16 safety standards
- ISO 9001 – 2001 certified factory
- Custom length units available upon request

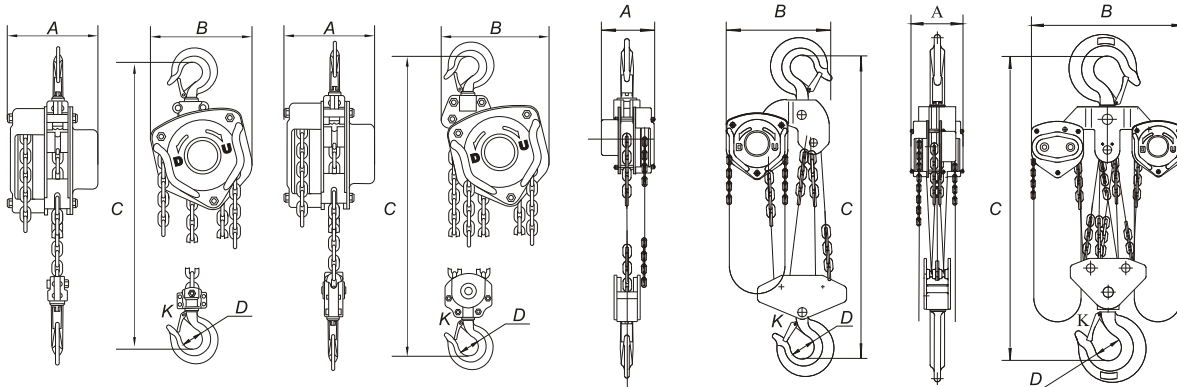

0.5t, 1t, 1.5t, 2t

3t, 5t

10t

20t

Capacity Metric Tons (t)	1/2	1	1-1/2	2	3	5	10	20
Proof Load (kN)	7.5	15	22.5	30	45	75	150	250
Effort (maximum lift) (N)	200	320	360	365	385	435	435	435 x 2
No. of falls, load chain	1	1	1	1	2	2	4	8
Load Chain (mm)	6 x 18	6 x 18	8 x 24	8 x 24	8 x 24	10 x 30	10 x 30	10 x 30
Dimensions (mm)	A	137.5	146.5	170	170	170	190	209
	B	137	162	183	194	220	288	384
	C	270	317	399	414	465	618	798
	D	35	35.5	45	42.5	50	64	85
	K	28	26	32.5	32	37	46	50
Net Weight (Kgs) based upon a 10Ft lift	9.3	11.4	16.7	18.5	21.2	41.8	81.7	173
Extra weight per Foot of extra lift (approx.) Kgs	0.52	0.52	0.70	0.70	1.13	1.71	2.96	5.91

Note: Units up to 50t available from our factory as a special order

MATERIAL HANDLING

TYPE 1 CHAIN HOISTS

Hoist No.	Tonnage Rating	Lift	Capacity (lbs)	Load Chain	Weight (kgs)	Vanguard Code
VCH 12	1/2	W/O	1,000	6 x 18	4.2	3850 0005
VCH 12x10	1/2	10	1,000	6 x 18	9.3	3850 1005
VCH 12x20	1/2	20	1,000	6 x 18	14.4	3850 2005
VCH 1	1	W/O	2,000	6 x 18	6.3	3850 0010
VCH 1x10	1	10	2,000	6 x 18	11.4	3850 1010
VCH 1x20	1	20	2,000	6 x 18	16.5	3850 2010
VCH 112	1-1/2	W/O	3,000	8 x 24	9.8	3850 0015
VCH 112x10	1-1/2	10	3,000	8 x 24	16.7	3850 1015
VCH 112x20	1-1/2	20	3,000	8 x 24	23.6	3850 2015
VCH 2	2	W/O	4,000	8 x 24	11.6	3850 0020
VCH 2x10	2	10	4,000	8 x 24	18.5	3850 1020
VCH 2x20	2	20	4,000	8 x 24	25.4	3850 2020
VCH 3	3	W/O	6,000	8 x 24	10.1	3850 0030
VCH 3x10	3	10	6,000	8 x 24	21.2	3850 1030
VCH 3x20	3	20	6,000	8 x 24	32.3	3850 2030
VCH 5	5	W/O	10,000	10 x 30	25.0	3850 0050
VCH 5x10	5	10	10,000	10 x 30	41.8	3850 1050
VCH 5x20	5	20	10,000	10 x 30	58.6	3850 2050
VCH 10	10	W/O	20,000	10 x 30	52.6	3850 00100
VCH 10x10	10	10	20,000	10 x 30	81.7	3850 10100
VCH 10x20	10	20	20,000	10 x 30	110.8	3850 20100
VCH 20	20	W/O	40,000	10 x 30	115.0	3850 00200
VCH 20x10	20	10	40,000	10 x 30	173.0	3850 10200
VCH 20x20	20	20	40,000	10 x 30	231.0	3850 20200



... Chain hoists with overload protection and/or custom lengths available upon request

PARTS FOR TYPE 1 CHAIN HOISTS

Capacity Metric Tons (t)		1/2	1	1-1/2	2	3	5
Load Chain	Dimensions (mm)	6 x 18	6 x 18	8 x 24	8 x 24	8 x 24	8 x 24
	Part Number	3858 0618	3858 0618	3858 0824	3858 0824	3858 0824	3858 1030
Bottom Hook Assembly*		3850 6005	3850 6010	3850 6015	3850 6020	3850 6030	3850 6060
Top Hook Assembly*			3850 5910	3850 5915	3850 5920	3850 5930	3850 5950
Latch Kits		3859 8005	3859 8007	3859 8015	3859 8020	3859 8030	3859 8060
Latch Kits for Integrated Hooks		3859 8205	3859 8207	3859 8215	3859 8220	3859 8230	3859 8260
Friction Discs (asbestos free)		3859 7005	3859 7007	3859 7015	3859 7015	3859 7015	3859 7030
Overload Device		3859 9005	3859 9007	3859 9015	3859 8020	3859 9030	3859 9060
Name Tag		3850 9105	3850 9110	3850 9115	3850 9120	3850 9130	3850 9150
Chain Guide		3850 92005	3850 92010	3850 92015	3850 92020	3850 92030	3850 92050

* Latch kits fit both the Top and Bottom Hooks

Warning:

NEVER EXCEED WORKING LOAD LIMITS!

FAILURE TO OBSERVE these warnings may result in serious injury or death!

- **ALWAYS** inspect all components frequently for signs of wear or damage
- **ALWAYS** keep load chains lubricated

PUSH TROLLEYS

- Meet ANSI B30.16 standards
- ISO 9001 – 2001 certified factory

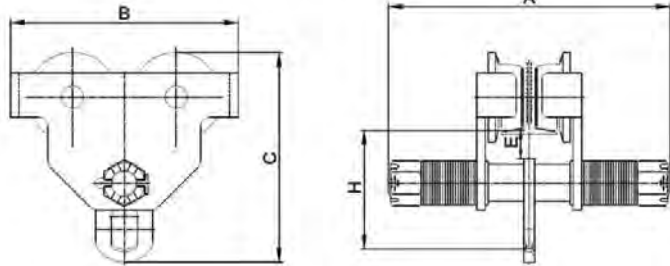

Model No.	Capacity Metric Tons	Weight (lbs)	Min. Radius of Curve (m)	I-Beam Width		Dimensions (inches)				Vanguard Code
				mm	inches	A	B	C	H	
VPT-C 12	1/2	18.92	0.9	64 - 152	2.52 - 5.98	10.39	8.50	7.68	4.33	3857 2005
VPT-C 1	1	33.88	1	64 - 203	2.52 - 7.99	13.19	10.24	9.41	5.35	3857 2010
VPT-C 2	2	50.60	1.1	88 - 203	3.46 - 7.99	13.90	11.81	11.26	6.34	3857 2020
VPT-C 3	3	96.36	1.3	102 - 305	4.02 - 12.00	14.61	13.58	13.23	7.28	3857 2030
VPT-C 5	5	110.00	1.4	114 - 305	4.49 - 12.00	15.47	15.35	15.47	8.66	3857 2050
VPT-C 10	10	225.50	1.7	117 - 305	4.61 - 12.00	20.94	18.50	19.68	11.02	3857 2100

Installation:

THE INSTALLATION of push trolleys must be performed by qualified riggers

Ensure that all safety regulations are complied with during installation (use of safety harnesses, evacuation of the areas, warning signs...etc).

Measure the actual width of the beam.

When required, assemble the correct number of spacer washers equally on both sides, to the inside of the trolley side plates. Make sure that the swivel hanger pin trolley wheel flanges are 6 mm greater than the runway beam width.

SLOWLY run the unit along the full length of the structure/runway beam to ensure safe factory operations, make all necessary adjustments **BEFORE** applying any load.

Warning:

FAILURE TO OBSERVE these warnings may result in serious injury or death!

- **NEVER EXCEED WORKING LOAD LIMITS**
- **During use, the accidental impacts or snagging of the loads being handled with surrounding objects may overload the units. Always remain aware of your surroundings.**
- **NEVER modify the equipment**
- **NEVER side pull the loads, and always ensure to centre the equipment above the load before lifting it**
- **DO NOT constantly use the end plates as a means of stopping**
- **DO NOT USE these push trolleys:**
 - unless the beam has been tested and approved for attaching lifting devices
 - unless the size range of the push trolley corresponds with the size of the beam
 - without making sure that the beam capacity exceeds the load rating of the push trolley
 - without making sure that the push trolley is fully tightened and properly engaged to the beam
 - without closely inspecting the push trolley for signs of wear or damage prior to use

MATERIAL HANDLING

BEAM CLAMPS

- Meet ANSI B30.16 standards
- ISO 9001 – 2001 certified factory

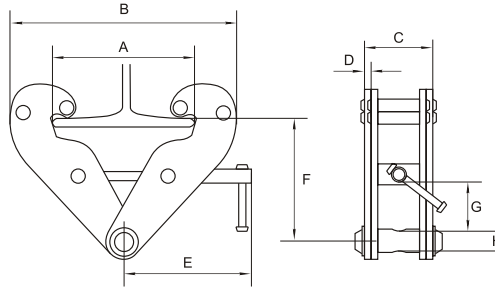

Capacity Metric Tons	Test Load (kN)	Weight (lbs)	Flange Width (mm)	Dimensions (mm)								Vanguard Code
				A	B	C	D	E	F	G	H	
1	14.71	8.82	75-230	240	192-367	94	4	194	102-154	22	20	3856 0001
2	29.42	10.58	75-230	240	192-367	102	8	194	102-154	22	20	3856 0002
3	44.13	21.61	80-345	355	243-520	132	8	241	133-223	38	22	3856 0003
5	73.50	25.57	80-345	355	243-520	142	10	241	133-223	35	28	3856 0005
10	147.00	37.48	80-350	360	272-532	180	12	284	155-234	47	38	3856 0010

Angle From Vertical	0°	0° to 15°	15° to 30°	30° to 45°
Reduction Factor	NIL	17%	34%	50%
Models	WLL	WLL	WLL	WLL
3856 0001	1T	0.8T	0.6T	0.5T
3856 0002	2T	1.6T	1.3T	1T
3856 0003	3T	2.5T	2T	1.5T
3856 0005	5T	4.1T	3.3T	2T
3856 0010	10T	8.3T	6.6T	5T

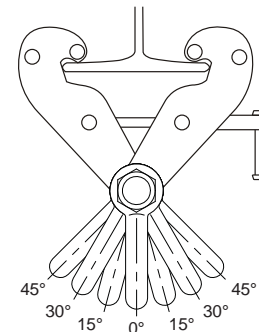

Installation:

THE INSTALLATION of beam clamps must be performed by qualified riggers
To attach clamps to a beam, open the jaws, slide the clamp over the flange and tighten the locking bar

Warning:

FAILURE TO OBSERVE these warnings may result in serious injury or death!

- **These Beam Clamps are designed as an Anchor Point for straight vertical lifts only and MUST NOT BE USED in case of side pulls or where the angle of a vertical lift exceeds 3 degrees**
- **NEVER EXCEED WORKING LOAD LIMITS**
- **NEVER LIFT LOADS OVER PEOPLE**
- **DO NOT USE these beam clamps:**
 - unless the beams have been tested and approved for attaching lifting devices
 - unless the size range of the clamp corresponds with the size of the beam flange
 - without making sure that they are fully tightened and properly engaged to support the load
 - without making sure that the beams' load rating exceeds the load rating of the beam clamp
 - without closely inspecting for signs of wear or damage prior to use
 - if the load swings during the lifting operation

VH CABLE PULLERS

Cable pullers are very versatile tools which are commonly used on construction sites, for laying of large pipes, installation and adjustments of machines, loading and unloading heavy and bulky goods, tensioning cables, tower erecting, stacking of forest products and the removal of obstacles.

- Compact, light weight units
- Extendable operating lever included with all units
- Low maintenance requirements
- Units are supplied without cable assembly
- Aluminum-alloy housing
- Heavy duty design, ensures a long and reliable service life
- Designed to operated in any position to lift, pull or lower materials
- The front and back clamping system provide a large surface contact area which evenly distributes the cable grip reducing cable wear while maximizing user safety
- The rope clamping system can be disengaged which offers smooth and easy installation of the cable assemblies
- Auto adjust device as a standard
- Standard overload protection for increased operator safety
- Specially built in shear pins can be replaced without removing the load



Model No.	Lifting Capacity (tons)	Pulling Capacity (lbs)	Rope advance per full stroke (inches)	Lever pull at WLL (lbs)	Weight (without cable) (lbs)	Vanguard Code
VH-008	0.8	2,750	2.36	55	15	3860 0008
VH-016	1.6	5,500	2.36	66	31	3860 0016
VH-032	3.2	11,000	1.57	110	51	3860 0032

Parts List Description	Vanguard Code
Shear Pins for VH-008	3860 1608
Shear Pins for VH-016 & VH-0032	3860 1632
Anchor Bolts for VH-008	3860 0908
Anchor Bolts for VH-016	3860 0916
Anchor Bolts for VH-032	3860 0932

Parts List Description	Vanguard Code
Telescopic Handle for VH-008	3860 3008
Telescopic Handle for VH-016 & VH-0032	3860 3032
Name Plates/Tags VH-008	3860 4708
Name Plates/Tags VH-016	3860 4716
Name Plates/Tags VH-032	3860 4732

CABLE ASSEMBLY

- Cable assemblies come complete with alloy hook and latch
- Galvanized cable offers excellent corrosion resistance and longer service life
- Reusable reel

Description	Weight (lbs)	Vanguard Code
5/16" x 66'	16	3860 0108
7/16" x 66'	30	3860 0116
5/8" x 66'	46	3860 0132



Custom lengths available upon request

Warning:

FAILURE TO OBSERVE these warnings may result in serious injury or death!

- **ALWAYS** inspect units and cable assemblies frequently for signs of wear or damage
- **NEVER** use for man-riding
- Cable pullers should only be operated by properly trained personnel

MATERIAL HANDLING

VCT-B SWIVEL STYLE CARGO TROLLEY

VCT-B Cargo Trolleys offer a safe and economical means of moving/transporting heavy products. They are available in 6, 8, 12 and 18 Metric Ton capacities.

Trolley Features:

- Units come with steel wheels
- Non marking polyurethane wheels also available
- Heavy duty compact construction provides a long reliable service life
- Closed sealed bearings which provide smooth operation and an excellent service life
- Low unit height makes these units ideal for almost any application



VCT-B Trolley Specifications					
Vanguard Code		3857 9008		3857 9018	
Capacity Metric Tons (t)		6	8	12	18
Length	mm	298	398	498	498
	inches	11.74	15.67	19.61	19.61
Width	mm	222	222	222	312
	inches	8.74	8.74	8.74	12.28
Height	mm	110	110	110	110
	inches	4.33	4.33	4.33	4.33
Weight	kgs	15.5	22.5	29.5	43.5
	pounds	34.14	49.56	64.98	95.82

* 6T and 12T units are not standard stock items

HANDLES FOR VCT-B SWIVEL STYLE CARGO TROLLEYS

Description	Vanguard Code
Handle for 6, 8 & 12 Ton Trolley	3857 9108
Handle for 18 Ton Trolley	3857 9118



POLYURETHANE WHEELS (PU)

- Fits all capacity of VCT-B cargo trolleys

6t unit requires 4 PU wheels
8t unit requires 6 PU wheels

12t unit requires 8 PU wheels
18t unit requires 10 PU wheels

Description	Vanguard Code
PU Wheels	3857 9101



Warning:

**FAILURE TO OBSERVE these warnings may result in serious injury or death!
NEVER EXCEED WORKING LOAD LIMITS!**

Inspect all components frequently for signs of wear or damage

Cargo Trolleys should only be used/installed by qualified/properly trained personnel

DRUM LIFTERS

- Compact light weight design
- All steel construction
- Designed to lift drums with or without lids. The clamps use the drums edge for lifting
- Grade 80 chain



Chain Specifications		Net Weight		Vanguard Code
Size	Length	Kgs	Lbs	
6 x 18mm	500mm / 19.69"	3.60	7.93	3808 9001

BUILDER'S HARDWARE



VANGUARD STEEL LTD.

NAILS

Common & Spiral Nails

- Extremely versatile nails
- Common nails have a smooth shank which reduces the risk of the wood splitting
- Spiral nails have a spiral line running down the nail, giving it similar gripping features to a screw
- Widely used in the housing/framing industry, for general carpentry and the construction industry
- Bright and hot dipped galvanized nails are well suited for both interior and exterior applications
- Galvanized nails offer the benefit of greater corrosion resistance
- Sold in 50Lb cartons (48 cartons/pallet)



Length	Vanguard Code		Penny Size	Gauge	Approximate Count/Lb
	Bright/Bare	Galvanized			
Common Nails					
2"	4101 2200	4101 7200	6d	11-1/2	170
2-1/2"	4101 2250	4101 7250	8d	10-1/4	100
3"	4101 2300	4101 7300	10d	8	66
3-1/4"	4101 2325	4101 7325	12d	8	61
3-1/2"	4101 2350	4101 7350	16d	8	47
4"	4101 2400	4101 7400	20d	6	30
6"	4101 2600		60d	2	11
8"	4101 2800		Spike	5/16"	4
10"	4101 21000		Spike	3/8"	3
12"	4101 21200		Spike	3/8"	2
Spiral					
1-1/2"		4101 6150	4d	15	400
2"	4101 5200	4101 6200	6d	11-1/2	173
2-1/2"	4101 5250		8d	10-1/4	108
3"	4101 5300	4101 6300	10d	9	70
3-1/4"	4101 5325		12d	9	64
3-1/2"	4101 5350	4101 6350	16d	8	49
4"	4101 5400		20d	6	32
6"	4101 5600		60d	2	14
8"	4101 5800		Spike	5/16"	5
10"	4101 51000		Spike	3/8"	4
12"	4101 51200		Spike	3/8"	2

*Additional lengths available upon request, minimum order quantities may apply

Warning:

FAILURE TO OBSERVE these warnings may result in serious injury and/or property damage

- **ALWAYS** make sure to wear goggles to protect your eyes when driving or extracting nails

BUILDER'S HARDWARE

NAILS

Double Headed Nails

- Designed for temporary applications, where the nail has to be removed
- The primary applications are in the construction industry such as concrete forming and scaffolding
- These nails are driven in only as far as the first head. The top of the nail head remains exposed making it easy to remove when required
- Nail length is measured from under the lower head to the point
- Bright/Bare Finish
- Sold in 50Lb cartons (48 cartons/pallet)

Concrete Nails

- Concrete nails are designed for use on uncured concrete, for use when joining wood to concrete
- Typical applications include attaching furring strips and plates
- Sold in 50Lb cartons – 10 x 5Lb boxes (48 cartons/pallet)

Length	Vanguard Code	Penny Size	Gauge	Approximate Count/Lb
Double Headed Nails				
2"	4101 1200	6d	12	156
2-1/4"	4101 1225	8d	10-1/4	90
2-3/4"	4101 1248	10d	9	59
3"	4101 1300	16d	8	45
3-1/4"	4101 1325	16d	7	43
3-1/2"	4101 1350	20d	6	28
Concrete Nails				
3/4"	4101 4034		9	240
1"	4101 4100		9	204
1-1/4"	4101 4116		9	167
1-1/2"	4101 4132		9	116
2"	4101 4200		9	93
3"	4101 4300		9	52



**Additional lengths available upon request, minimum order quantities may apply*

Warning:

FAILURE TO OBSERVE these warnings may result in serious injury and/or property damage

- **ALWAYS** make sure to wear goggles to protect your eyes when driving or extracting nails

FORMING STAKES

- Manufactured from high quality steel
- The pointed end is designed to minimize rock deflection when inserted
- Vanguard forming stakes are equipped with spiral patterned nail holes for use as form pins
- Standard pack size: 10 pcs/bundle



Dimensions (Diameter x Length)	Vanguard Code
Black Finish	
3/4" x 18"	4101 3418
3/4" x 24"	4101 3424
3/4" x 30"	4101 3430
3/4" x 36"	4101 3436
3/4" x 48"	4101 3448

**Additional diameters and lengths available upon request, minimum order quantities may apply*

ANCHOR BOLTS

- Anchor bolts are commonly used in new construction
- The anchor bolts are inserted into the concrete while it is still wet, with the threaded portion sticking up. When the concrete hardens the bolt is set in place and objects can be bolted down with the use of a nut
- This versatile product is commonly used for a variety of applications include attaching wooden frames to walls, construction of buildings, anchoring shear walls and/or paneling of walls, holding beams in position for walls or large structures



Description	Standard Package Quantity (Pcs)	Vanguard Code
Self Colored Finish		
L-Shaped Anchor Bolts 1/2" x 8"	50	4109 3208
L-Shaped Anchor Bolts 3/4" x 16"	50	4109 4816
L-Shaped Anchor Bolts 1" x 24"	20	4109 6424
PigTail Anchor Bolts 1/2" x 6"	50	4109 03206
PigTail Anchor Bolts 1/2" x 8"	50	4109 03208
PigTail Anchor Bolts 5/8" x 8"	25	4109 04008
PigTail Anchor Bolts 5/8" x 10"	25	4109 04010

**Additional diameters, lengths and finishes available upon request, minimum order quantities may apply*

Warning:

FAILURE TO OBSERVE these warnings may result in serious injury and/or property damage

- **ALWAYS** make sure to wear goggles to protect your eyes when driving or extracting forming stakes

BUILDER'S HARDWARE

ANNEALED WIRE

- Soft annealed wire offer excellent flexibility making them easier to use
- These types of wire are widely used in construction and agricultural applications
- Typical agricultural applications include bailing of hay
- Black annealed wire is sometimes referred to as “burnt wire”
- Galvanized annealed wires offer the benefits of greater corrosion resistance
- Galvanized High Tensile (HT) wires are widely used in the vineyard industry
- Standard pack size: Each or 10 coils/bundle

Dimensions (Diameter x Package Size)	Approx. Length (feet)	Vanguard Code
Black Annealed Finish		
9 G x 10 lb Coil	170	4102 1009
12 G x 10 lb Coil	336	4102 1012
14 G x 10 lb Coil	580	4102 1014
16G x 10 lb Coil	949	4102 1016
9 G x 50 lb Coil	850	4102 0009
12 G x 50 lb Coil	1,680	4102 0012
14 G x 50 lb Coil	2,900	4102 0014
16 G x 50 lb Coil	4,750	4102 0016
Hot Dipped Galvanized Annealed Wire		
9 G x 10 lb Coil	170	4103 1009
12 G x 10 lb Coil	336	4103 1012
14 G x 10 lb Coil	580	4103 1014
9 G x 50 lb Coil	850	4103 0009
12 G x 50 lb Coil	1,680	4103 0012
14 G x 50 lb Coil	2,900	4103 0014
16 G x 50 lb Coil	4,750	4103 0016
Hot Dipped Galvanized - High Tensile (HT) Annealed Wire		
12.5 G HT x 2000' Coil	2,000	4103 0125
Oil Annealed Wire		
9 G x 10 lb Coil	170	4105 1009
12 G x 10 lb Coil	336	4105 1012
9 G x 50 lb Coil	850	4105 0009
12 G x 50 lb Coil	1,680	4105 0012



**Additional diameters and lengths available upon request, minimum order quantities may apply*

Warning:

- FAILURE TO OBSERVE these warnings may result in serious injury and/or property damage**
- **ALWAYS** make sure to wear goggles to protect your eyes when working with wire products

STAINLESS STEEL LASHING WIRE

- Grade 430 Stainless steel offers good corrosion resistance at an economical price
- Well suited for most environments
- Commonly used in the utility and telecommunication industry

Diameter (inches)	Length (Feet)	Vanguard Code
0.045	1,200	4104 1143-430

6 coils/carton, 336 coils/pallet / Sold in full box quantities



REBAR TIE WIRE

- Rebar tie wire is used as binding wires
- Manufactured from soft annealed wire, which ensures the wire consistently forms the perfect tie every time
- Typical uses include bundling construction material together, securing rebar in the correct position to achieve the required strength of the complete concrete structure
- Galvanized rebar tie wire offers the benefits of greater corrosion resistance
- PVC coated tie wires offer a longer service life when compared to bright and hot dipped galvanized rebar tie wire
- Standard pack size: Each or 16 Coils/Box

Dimensions (Diameter x Package Size)	Approx. Length (feet)	Vanguard Code
Bright Finish		
16 G x 3-1/8 lb Coil	340	4104 0016
16.5 G x 3-1/8 lb Coil	400	4104 00165
Hot Dipped Galvanized Finish		
16 G x 3-1/8 lb Coil	340	4104 00161
Green PVC Finish		
16 G x 2-1/2 lb Coil	170	4104 1016

**Additional diameters and lengths available upon request, minimum order quantities may apply*



REBAR TIE WIRE DISPENSER

- This tool offers a light weight, reliable means of carrying large volume of tie wire
- It is designed to be worn on the users utility belt
- The tie wire fits neatly inside the dispenser protecting the user's eyes from flying wire ends
- New coils of wire can be loaded in a minimum amount of time
- Standard pack size: Each or 5 Pcs/Carton

Description	Vanguard Code
Aluminum Rebar Tie Wire Dispenser	4104 9001



Warning:

- FAILURE TO OBSERVE these warnings may result in serious injury and/or property damage**
- **ALWAYS** make sure to wear goggles to protect your eyes when working with wire products

TIE WIRE LOOPS

- Tie wire loops are used as a binding wire
- Manufactured from soft annealed wire, ensuring excellent quality and performance
- These wires are widely used in the construction, industrial and agricultural industries
- Typical uses include bundling construction material together, securing rebar before pouring concrete, bundling recycled materials such as cardboard, and as a bag sealing/packaging product
- Galvanized tie wire loops offer the benefits of greater corrosion resistance
- Standard pack size: 2500 Pcs/Bundle

Dimensions (Diameter x Length)	Vanguard Code		
	Bright Finish	Hot Dipped Galvanized Finish	PVC Green
16 G x 3-1/2"	4104 0003	4104 1003	4104 4003
16 G x 4"	4104 0004	4104 1004	4104 4004
16 G x 5"	4104 0005	4104 1005	4104 4005
16 G x 6"	4104 0006	4104 1006	4104 4006
16 G x 7"	4104 0007	4104 1007	4104 4007
16 G x 8"	4104 0008	4104 1008	4104 4008
16 G x 9"	4104 0009	4104 1009	4104 4009
16 G x 10"	4104 0010	4104 1010	4104 4010
16 G x 12"	4104 0012	4104 1012	4104 4012



**Additional diameters and lengths available upon request, minimum order quantities may apply*

STRAIGHT CUT ANNEALED WIRE

- Soft annealed wires offer excellent flexibility making the wires easier to use
- The galvanizing offers greater corrosion resistance than bright finish wires
- This type of wire is widely used in the industrial and construction industries
- Typical industrial/construction uses include the hanging of suspended ceilings
- Standard pack size: 25 Lbs/Carton

Dimensions (Diameter x Length)	Vanguard Code
Hot Dipped Galvanized Finish	
18 G x 27" Straight Cut	4103 1827



**Additional diameters and lengths and finishes available upon request, minimum order quantities may apply*

Warning:

- FAILURE TO OBSERVE these warnings may result in serious injury and/or property damage**
- **ALWAYS** make sure to wear goggles to protect your eyes when working with wire products

TIE WIRE TWISTING TOOL

- Tie wire twisting tools are designed to twist looped rebar tie wire, using a minimum amount of effort
- The compact design allows this tool to be used in tight spaces
- The plastic handle will not rot, increasing the tools service life
- Standard pack size: Each or 5 Pcs/Carton

Description	Vanguard Code
Tie Wire Twisting Tool	4104 9000



AUTOMATIC TWISTING TOOL

- This tool allows the user to tie wire faster, saving time and increasing efficiency
- The automatic wire twisting tool features include heavy-duty, galvanized-steel construction and a unique spring-return action that requires very little effort
- The rubber handle cover provides a secure gripping surface when in use, and the bright red color makes this tool easy to find if dropped
- Standard pack size: Each or 50 Pcs/Carton

Description	Vanguard Code
Automatic Wire Twisting Tool	4104 9002



Warning:

- FAILURE TO OBSERVE these warnings may result in serious injury and/or property damage**
- **ALWAYS** make sure to wear goggles to protect your eyes when working with wire products

BUILDER'S HARDWARE

HARDWARE CLOTH

- Hardware cloth is welded into uniform sizes
- It is galvanized after welding, which provides the greatest corrosion resistance
- The end product has a smooth surface finish which is level and flat, offering even strength throughout the roll
- The wire shows no signs of wear and tear when cut into smaller sections
- This material is widely used for industrial, construction, agricultural and residential applications
- Standard pack size: 1 Roll

Dimensions (Mesh Size x Roll Height x Length)	Wire Gauge	Vanguard Code
Hot Dipped Galvanized Finish		
1/8" x 36" x 25'	23	4107 0362
1/8" x 36" x 50'	23	4107 0365
1/8" x 36" x 100'	23	4107 0361
1/8" x 48" x 50'	23	4107 0485
1/8" x 48" x 100'	23	4107 0481
1/4" x 24" x 50'	23	4107 1245
1/4" x 30" x 50'	23	4107 1305
1/4" x 36" x 6'	23	4107 1366
1/4" x 36" x 25'	23	4107 1362
1/4" x 36" x 50'	23	4107 1365
1/4" x 36" x 100'	23	4107 1361
1/4" x 48" x 50'	23	4107 1485
3/8" x 36" x 50'		4107 2365
1/2" x 24" x 50'	19	4107 3245
1/2" x 36" x 6'	19	4107 3366
1/2" x 36" x 25'	19	4107 3362
1/2" x 36" x 50'	19	4107 3365
1/2" x 36" x 100'	19	4107 3361
1/2" x 48" x 50'	19	4107 3485
3/4" x 36" x 6'		4107 4366
3/4" x 36" x 25'		4107 4362
3/4" x 36" x 50'		4107 4365
3/4" x 36" x 100'		4107 4361
1" x 36" x 25'		4107 5362
1" x 36" x 50'		4107 5365
1" x 36" x 100'		4107 5361



**Additional mesh sizes, roll heights, lengths and coatings/finishes available upon request, minimum order quantities may apply*

Warning:

- FAILURE TO OBSERVE these warnings may result in serious injury and/or property damage**
- **ALWAYS** make sure to wear goggles to protect your eyes when working with wire products

POULTRY NETTING

- The wire is galvanized prior to welding
- The galvanized wire is then welded into uniform hexagon mesh, which provides a smooth finish to the wire surface
- The horizontal shape helps to keep the fence straight and upright
- Typical applications for this material include the construction of poultry and pet pens, barriers for garden pests
- Standard pack size: 1 Roll

Dimensions (Mesh Size x Roll Height x Length)	Wire Gauge	Vanguard Code
Hot Dipped Galvanized Finish		
1/2" x 24" x 50'	22	4106 0245
1/2" x 30" x 50'	22	4106 0305
1/2" x 36" x 25'	22	4106 0362
1/2" x 36" x 50'	22	4106 0365
1/2" x 48" x 50'	22	4106 0485
1" x 24" x 25'	20	4106 1242
1" x 24" x 50'	20	4106 1245
1" x 24" x 100'	20	4106 1241
1" x 30" x 50'	20	4106 1305
1" x 36" x 25'	20	4106 1362
1" x 36" x 50'	20	4106 1365
1" x 36" x 100'	20	4106 1361
1" x 48" x 25'	20	4106 1482
1" x 48" x 50'	20	4106 1485
1" x 48" x 100'	20	4106 1481
1" x 60" x 50'	20	4106 1605
1" x 72" x 50'	20	4106 1725
2" x 24" x 25'	20	4106 2242
2" x 24" x 50'	20	4106 2245
2" x 24" x 100'	20	4106 2241
2" x 30" x 50'	20	4106 2305
2" x 36" x 25'	20	4106 2362
2" x 36" x 50'	20	4106 2365
2" x 36" x 100'	20	4106 2361
2" x 48" x 25'	20	4106 2482
2" x 48" x 50'	20	4106 2485
2" x 48" x 100'	20	4106 2481
2" x 60" x 50'	20	4106 2605
2" x 60" x 100'	20	4106 2601
2" x 72" x 50'	20	4106 2725

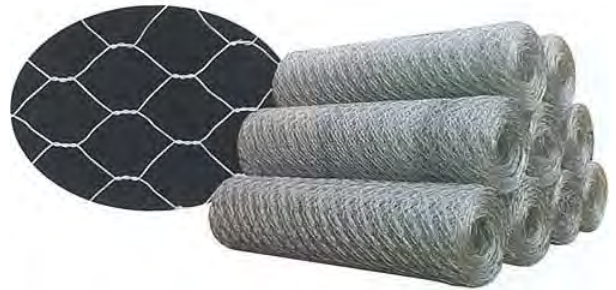

**Additional mesh sizes, roll heights, lengths and coatings/finishes available upon request, minimum order quantities may apply*

Warning:

- FAILURE TO OBSERVE these warnings may result in serious injury and/or property damage**
- **ALWAYS** make sure to wear goggles to protect your eyes when working with wire products

STEEL STRAPPING

- Painted black and waxed
- Elongation 5.2 to 6.5%
- Made with high tensile steel
- Packaged in coils of 45 kgs / 12 coils per skid



Width (inches)	Thickness (inches)	Average Strength (lbs)	Coil Winding	Vanguard Code
1/2	0.020	1,230	oscillated	4201 2032
5/8	0.020	1,550	oscillated	4201 2040
3/4	0.023	2,200	oscillated	4201 2348
1-1/4	0.025	4,060	ribbon	4201 25116

DISPENSERS FOR STEEL STRAPPING



4203 30112



4203 30200



Automatic brake



Trolley brake

Strapping Width (inches)	Description	Weight (lbs/ea)	Vanguard Code
3/8 - 1-1/2	AUTOMATIC BRAKE, 10" DIAMETER WHEELS VGD720HS TROLLEY TYPE WITH TOOL BOX, OUTER STEEL DISC 25" IN DIAMETER	59	4203 30112
3/8 - 2	TROLLER BRAKE, 8" DIAMETER WHEELS, VGD430HS TROLLEY TYPE WITH TOOL BOX, OUTER STEEL DISC 28" IN DIAMETER	75	4203 30200

Note:

These products are suitable for all general strapping and packaging applications.

TOOLS FOR STEEL STRAPPING

Strapping Width (inches)	Description	Weight (lbs/ea)	Vanguard Code
Tensioning Tools			
3/8 - 3/4	Feed Wheel Tensioner VGD290	4.50	4203 02448
5/8 - 1-1/4	Superior Push Tensioner VGD247	7.10	4203 040116
Sealing Tools			
1/2	Sealer Double Notched VGD3104	2.00	4203 10032
5/8	Sealer Double Notched VGD3105	2.00	4203 10040
3/4	Sealer Double Notched H.D. VGD3226	3.36	4203 10048
1-1/4	Sealer Double Notched Side Action VGD3180	7.10	4203 10116
1-1/4	Sealer Single Notched Side Action H.D. VGD3173	6.70	4203 11116
Cutting Tools			
3/8 - 3/4	Cutter Drop Forged VGD100	1.31	4203 22448
3/8 - 1-1/4	Cutter Heavy Duty VGD230	1.91	4203 224116



4203 02448



4203 040116



4203 10032 / 40



4203 10048



4203 22448



4203 224116



4203 10116



4203 11116

STEEL SEALS FOR STEEL STRAPPING

Width (inches)	Thickness (inches)	Packaging (pcs)	Seal Type	Vanguard Code
1/2	1.00	1,000	open	4202 0032
5/8	1.00	1,000	open	4202 0040
3/4	1.11	1,000	open	4202 0048
1-1/4	2.24	500	push	4202 1116

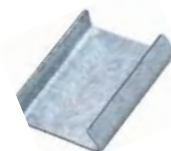

OPEN TYPE



PUSH TYPE

T-POSTS

- Features an angled stud that helps hold the fence against the post
- Green enamel finish for greater rust resistance above and below ground
- Permanent or temporary installation

Common uses include:

- Snow Fence
- Construction Fencing
- Agricultural/Farm Fencing
- Barbed Wire Fencing
- Tree Staking
- Sign Posts



Colour	Weight (ft./lbs)	Available Lengths (ft.)			
		6	7	8	10
Unpainted	0.95	4204 0856			
Green	0.95	4204 0956	4204 0957	4204 0958	
Brown	1.33	4204 1336	4204 1337		4204 13310

Packing: 5pcs/bundle, 200pcs/pallet
 Studded and with spade available upon request, minimum order quantity may apply



POST POUNDER

- For driving t-posts and u-posts into the ground
- Weighted, reinforced steel head minimizes damage to post tops
- Delivers over 15 pounds of force reducing operator fatigue
- 2-3/4" Inside driver diameter
- 23-1/2" Overall length



Description	Vanguard Code
T-Post Pounder	4204 1000

SLINGS



VANGUARD STEEL LTD.

'GOLDEN EYE' WIRE ROPE LIFTING SLINGS

- Manufactured with 6x26 IWRC EIPS Bright Wire Rope with One Golden Strand.
- In accordance to ASME B30.9
- Single leg, ungalvanized
- Standard Eye / Eye



Length (ft)	Hitch Type (WLL) (lbs)			Weight (lbs/pc)	Vanguard Code
	Vertical	Choker	Basket 90°		
1/4" DIAMETER					
4	1,300	960	2,600	1.00	3202 1604
6	1,300	960	2,600	1.20	3202 1606
8	1,300	960	2,600	1.45	3202 1608
10	1,300	960	2,600	1.67	3202 1610
12	1,300	960	2,600	1.90	3202 1612
3/8" DIAMETER					
4	2,800	2,200	5,800	1.92	3202 2404
6	2,800	2,200	5,800	2.44	3202 2406
8	2,800	2,200	5,800	2.95	3202 2408
10	2,800	2,200	5,800	3.46	3202 2410
12	2,800	2,200	5,800	4.00	3202 2412
1/2" DIAMETER					
4	5,000	3,800	10,200	3.70	3202 3204
6	5,000	3,800	10,200	4.60	3202 3206
8	5,000	3,800	10,200	5.53	3202 3208
10	5,000	3,800	10,200	6.42	3202 3210
12	5,000	3,800	10,200	7.35	3202 3212
5/8" DIAMETER					
4	7,800	5,800	15,600	6.25	3202 4004
6	7,800	5,800	15,600	7.70	3202 4006
8	7,800	5,800	15,600	9.15	3202 4008
10	7,800	5,800	15,600	10.57	3202 4010
12	7,800	5,800	15,600	12.10	3202 4012
3/4" DIAMETER					
4	11,200	8,200	22,000	9.40	3202 4804
6	11,200	8,200	22,000	11.50	3202 4806
8	11,200	8,200	22,000	13.55	3202 4808
10	11,200	8,200	22,000	15.63	3202 4810
12	11,200	8,200	22,000	17.60	3202 4812
1" DIAMETER					
4	19,600	14,400	40,000	18.20	3202 6404
6	19,600	14,400	40,000	22.00	3202 6406
8	19,600	14,400	40,000	25.56	3202 6408
10	19,600	14,400	40,000	29.35	3202 6410
12	19,600	14,400	40,000	33.05	3202 6412

SLINGS

'GOLDEN EYE' WIRE ROPE LIFTING SLINGS

- Manufactured with 6x26 IWRC EIPS galvanized wire rope
- Solid identification tags on each sling
- In accordance to ASME B30.9
- Single leg, galvanized
- Standard Eye / Eye



Length (ft)	Hitch Type (WLL) (lbs)			Weight (lbs/pc)	Vanguard Code
	Vertical	Choker	Basket 90°		
1/4" DIAMETER					
4	1,300	960	2,600	1.00	3203 1604
6	1,300	960	2,600	1.20	3203 1606
8	1,300	960	2,600	1.45	3203 1608
10	1,300	960	2,600	1.67	3203 1610
12	1,300	960	2,600	1.90	3203 1612
3/8" DIAMETER					
4	2,800	2,200	5,800	1.92	3203 2404
6	2,800	2,200	5,800	2.44	3203 2406
8	2,800	2,200	5,800	2.95	3203 2408
10	2,800	2,200	5,800	3.46	3203 2410
12	2,800	2,200	5,800	4.00	3203 2412





Synthetic web slings offer a number of advantages for rigging purposes. The web slings are an excellent choice where highly finished parts or delicate equipment must be protected from damage.

The synthetic material has stretch and flexibility which allow them to mould to the shape of the load, gripping securely, while cushioning and absorbing shock more than that of a wire rope or chain. They are lightweight and very easy to handle.



Webbing Width (inches)	Single Leg – Hitch Type		Two Leg – Horizontal Angles				Vanguard Code (XX - Sling Length)	
	Vertical	Choker	Vertical Basket	60°	45°	30°	Type 3	Type 4
Rated Loads for Single Ply Class 7 Synthetic Slings – Types 3 and 4								
1	1,600	1,280	3,200	2,770	2,260	1,600	3403 11XX	-
2	3,100	2,480	6,200	5,360	4,380	3,100	3403 12XX	-
3	4,700	3,760	9,400	8,140	6,640	4,700	3403 13XX	-
4	6,200	4,960	12,400	10,730	8,760	6,200	3403 14XX	-
Rated Loads for Two Ply Class 7 Synthetic Slings – Types 3 and 4								
1	3,100	2,480	6,200	5,300	4,300	3,100	3403 01XX	3404 01XX
2	6,200	4,960	12,400	10,700	8,700	6,200	3403 02XX	3404 02XX
3	8,800	7,040	17,600	15,200	12,400	8,800	3403 03XX	3404 03XX
4	11,000	8,800	22,000	19,000	15,500	11,000	3403 04XX	3404 04XX
6	16,500	13,200	33,000	28,600	23,000	16,500	-	3404 06XX
Rated Capacity in Pounds, Full Safety Factor of 5:1								

We offer these slings in various widths, lengths and configurations

XX - Sling Length

- Type 3 - Flat Eye and Eye
- Type 4 - Twisted Eye and Eye
- Type 5 - Endless

Vanguard Polyester slings are tested in accordance with the requirements of ASME / ANSI B 30.9 and are made of class 7 material with a minimum certified tensile strength of 9800 lbs per inch of width.

Environmental Considerations:

- Polyester slings should never be used at temperatures in excess of 90°C (194°F), they can however be used in temperatures as low as -40°C (-40°F)
- Slings should be stored in a cool, dry, and dark place, and should not be exposed to ultra-violet light such as sunlight
- Environments in which synthetic web slings are continuously exposed to ultra-violet light can affect the strength of synthetic webbing in varying degrees, ranging from slight to total degradation. The degradation is also cumulative.

POLYESTER ENDLESS LIFTING SLINGS - TYPE 5 - 2 PLY

Synthetic web slings offer a number of advantages for rigging purposes. The web slings are an excellent choice where highly finished parts or delicate equipment must be protected from damage.

- Lifting slings may be used in a vertical, choker or basket type hitch
- They are light weight and easy to handle
- Safety factor 5:1
- Tested in accordance with the requirements of ASME / ANSI B 30.9 and are made of class 7 material with a minimum certified tensile strength of 9800 lbs per inch of width.



Length (ft)	Hitch Type (WLL) (lbs)			Weight (lbs/pc)	Vanguard Code
	Vertical	Choker	Basket 90°		
1" WIDTH					
4	6,200	4,960	12,400	1.20	3405 0104
6	6,200	4,960	12,400	1.80	3405 0106
8	6,200	4,960	12,400	2.20	3405 0108
10	6,200	4,960	12,400	2.76	3405 0110
2" WIDTH					
4	12,400	9,920	24,800	3.31	3405 0204
6	12,400	9,920	24,800	4.15	3405 0206
8	12,400	9,920	24,800	5.00	3405 0208
10	12,400	9,920	24,800	5.15	3405 0210
3" WIDTH					
4	17,600	14,080	35,200	3.09	3405 0304
6	17,600	14,080	35,200	4.41	3405 0306
8	17,600	14,080	35,200	4.96	3405 0308
10	17,600	14,080	35,200	5.20	3405 0310
4" WIDTH					
6	22,000	17,600	44,000	5.51	3405 0406
8	22,000	17,600	44,000	7.06	3405 0408
10	22,000	17,600	44,000	8.82	3405 0410

POLYESTER ENDLESS ROUND SLINGS

The most basic round sling, yet they offer great versatility.

Made from a continuous loop of polyester fibers encased in a tough double wall tubular polyester cover, they are light in weight, but high in strength, conforming well to irregularly shaped loads.

- Endless round slings may be used in a vertical, choker or basket type hitch.
- Sling life extended through rotation of bearings points.
- Low stretch 3%, at rated capacity
- Round Slings are colour-coded according to the work load limit (WLL)
- Tested in accordance with the requirements of ASME / ANSI B 30.9



Length (ft)	Hitch Type (WLL) (lbs)			Weight (lbs/pc)	Vanguard Code
	Vertical	Choker	Basket 90°		
ENRS-1 PURPLE					
3	3,000	2,400	6,000	0.77	3406 1003
4	3,000	2,400	6,000	1.05	3406 1004
6	3,000	2,400	6,000	1.56	3406 1006
8	3,000	2,400	6,000	2.08	3406 1008
10	3,000	2,400	6,000	2.60	3406 1010
ENRS-2 GREEN					
2	6,000	4,800	12,000	0.84	3406 2002
3	6,000	4,800	12,000	1.24	3406 2003
4	6,000	4,800	12,000	1.67	3406 2004
6	6,000	4,800	12,000	2.50	3406 2006
8	6,000	4,800	12,000	3.33	3406 2008
10	6,000	4,800	12,000	4.15	3406 2010
12	6,000	4,800	12,000	5.00	3406 2012
16	6,000	4,800	12,000	6.80	3406 2016
20	6,000	4,800	12,000	8.30	3406 2020
ENRS-3 YELLOW					
3	9,000	7,200	18,000	1.56	3406 3003
4	9,000	7,200	18,000	2.15	3406 3004
6	9,000	7,200	18,000	3.10	3406 3006
8	9,000	7,200	18,000	4.20	3406 3008
10	9,000	7,200	18,000	5.35	3406 3010
12	9,000	7,200	18,000	6.30	3406 3012
14	9,000	7,200	18,000	7.25	3406 3014
16	9,000	7,200	18,000	8.30	3406 3016
20	9,000	7,200	18,000	10.60	3406 3020

Warning:

**NEVER EXCEED WORKING LOAD LIMITS!
FAILURE TO FOLLOW INSTRUCTIONS CAN RESULT IN SERIOUS INJURY!**

POLYESTER ENDLESS ROUND SLINGS

- Endless round slings may be used in a vertical, choker or basket type hitch.
- Sling life extended through rotation of bearings points.
- Low stretch 3%, at rated capacity
- Round Slings are colour-coded according to the work load limit (WLL)
- Tested in accordance with the requirements of ASME / ANSI B 30.9



Length (ft)	Hitch Type (WLL) (lbs)			Weight (lbs/pc)	Vanguard Code
	Vertical	Choker	Basket 90°		
ENRS-5 RED					
3	14,000	11,200	28,000	2.60	3406 5003
4	14,000	11,200	28,000	3.50	3406 5004
6	14,000	11,200	28,000	5.20	3406 5006
8	14,000	11,200	28,000	6.92	3406 5008
10	14,000	11,200	28,000	8.60	3406 5010
12	14,000	11,200	28,000	10.50	3406 5012
16	14,000	11,200	28,000	13.85	3406 5016
20	14,000	11,200	28,000	17.50	3406 5020
ENRS-7 BLUE					
6	23,000	18,400	46,000	7.60	3406 7006
8	23,000	18,400	46,000	10.50	3406 7008
10	23,000	18,400	46,000	12.66	3406 7010
12	23,000	18,400	46,000	15.20	3406 7012
16	23,000	18,400	46,000	20.60	3406 7016
20	23,000	18,400	46,000	25.80	3406 7020
ENRS-9 GREY					
6	32,000	25,600	64,000	10.80	3406 9006
10	32,000	25,600	64,000	17.80	3406 9010
12	32,000	25,600	64,000	21.50	3406 9012
16	32,000	25,600	64,000	28.50	3406 9016
20	32,000	25,600	64,000	35.60	3406 9020

Warning:

**NEVER EXCEED WORKING LOAD LIMITS!
FAILURE TO FOLLOW INSTRUCTIONS CAN RESULT IN SERIOUS INJURY!**

Environmental Considerations Continued:

- Chemicals can also have an adverse effect on polyester slings, please see the following chart for safe and unsafe chemicals

Chemicals	Safe/Unsafe	Chemicals	Safe/Unsafe	Chemicals	Safe/Unsafe
Acid	Safe	Sulfuric Acid	Unsafe	Alcohols	Safe
Weak Alkalis	Safe	Strong Alkalis	Safe *	Aldehydes	Unsafe
Bleaching Agents	Safe	Ether	Unsafe	Hydro-Carbons	Safe
Ketones	Safe	Soaps/Detergents	Safe	Water & Seawater	Safe
Dry Cleaning Solvents	Safe	Oils (Crude)	Safe	Lubricant Oils	Safe

* Polyester is degraded by strong alkalis at elevated temperatures



FAILURE TO OBSERVE THESE WARNINGS MAY RESULT IN SERIOUS INJURY OR DEATH!

- ALWAYS** inspect polyester slings prior to each use, the inspection should be performed by a properly trained competent person
- NEVER** exceed the WLL of the of the sling
- NEVER** lift a load over or near people
- When using sling in a basket hitch **ALWAYS** make sure that the load is properly balanced to prevent slippage
- Slings should **NEVER** be dragged on the floor or over an abrasive surface
- NEVER** twist or tie slings into knots, or join slings by knotting
- NEVER** pull a sling from under loads when the load is resting on the sling
- ALWAYS** make sure that slings are protected from being cut by sharp corners, sharp edges, protrusions or abrasive surfaces
- NEVER** drop slings equipped with metal fittings
- ALWAYS** make sure that the opening in fittings shall be the proper shape and size to insure that the fitting will seat properly in the hook or other attachment
- When using a sling as a choker hitch **ALWAYS** make sure that the sling is long enough to ensure that the choking action is on the webbing
- Slings should **ALWAYS** be stored in a cool, dry, and dark place, and should not be exposed to ultra-violet light such as sunlight

Slings showing any of these conditions must be removed from service immediately:

- The sling identification tag is missing or not legible
- Acid or caustic burns
- Holes, tears cuts, snags or melting or charring
- Stitching is broken or worn in the load bearing splices
- Signs of excessive abrasive wear
- Discoloration or brittle/stiff areas on any part of the sling (as this may indicate chemical or ultraviolet/sunlight damage)
- There should be no knots in any part of the sling
- If the sling has fittings they should be checked to ensure that they are not pitted, corroded, cracked, bent, twisted, gouged, or broken
- For hooks, removal criteria as stated in ASME B30.10
- For rigging hardware, removal criteria as stated in ASME B30.26
- There is visible damage that cause doubt as to the continued use of the sling



CONVERSIONS

To Convert	Multiply By	To Obtain	To Convert	Multiply By	To Obtain
Miles (statute)	1.609	Kilometers		0.621	Miles (statute)
Yards	0.914	Meters		1.094	Yards
Feet	0.305	Meters		3.281	Feet
Inches	25.400	Millimeters		0.039	Inches
Short Tons	0.907	Metric Tons		1.102	Short Tons
Long Tons	1.016	Metric Tons		0.984	Long Tons
Pounds	0.454	Kilograms		2.205	Pounds
Pounds	0.00444	Kilo newtons		224.8	Pounds
Pounds per Foot	1.488	Kilos per Meter		0.672	Pounds per Foot
Pounds per sq. ft.	4.882	Kilos per sq. m		0.205	Pounds per sq. ft.
Pounds per sq. in.	0.070	Kilos per sq. cm		14.223	Pounds per sq. in.
Square Inches	645.200	Sq. Millimeters		0.002	Square Inches
Cubic Inches	16.387	Cubic Centimeters		0.061	Cubic Inches
Cubic Feet	0.028	Cubic Meters		35.310	Cubic Feet
Cubic Yards	0.765	Cubic Meters		1.308	Cubic Yards
U.S. Gallons	3.785	Liters		0.264	U.S. Gallons
Imperial Gallons	4.546	Liters		0.220	Imperial Gallons
Cubic Feet	28.320	Liters		0.035	Cubic Feet
Diameter	3.142	Circumference		0.318	Diameter
Deg. Fahrenheit	.5556 x (F° - 32)	Degrees Celsius		(1.8 x C°) + 32	Deg. Fahrenheit
1 Statute Mile -	1760 Yards -	5280 Feet -		1.60934 Km	
1 Nautical Mile -	6080 Feet -	1.85318 Km			
1 Fathom -	6 Feet -	1.82880 Meters			
1 Rod -	5.5 Yards -	16.5 Feet -		5.02919 Meters	



VANGUARD STEEL LTD.