

OUTBOUND

SUPA WING AWNING



SUPAPEG
OUTDOOR GEAR CO.

better outdoors

SUPA WING AWNING

Ideal for caravans or camping trailers, this awning is designed for a large but simple setup. With a UPF 50+ rating, it provides shade to the side and rear of your set up.

Our Supa Wing Awning has a heavy-duty aluminium extrusion that increases its strength and prevents it from bending or flexing. The horizontal hinging system holds 6 arms that fold out to give the awning its wing shape. The awning's 8 aluminium twist lock legs have a swing down mechanism that makes setting up a breeze.

Keep your set up simple with the awning legs having our unique peggable foot, so no guy ropes are needed unless on the beach or in strong wind conditions.

Manufactured from UV treated, Australian made, 275 GSM Dynaproof Canvas which is mould & mildew resistant, the Supa Wing Awning is tested for Australian conditions and designed to last!



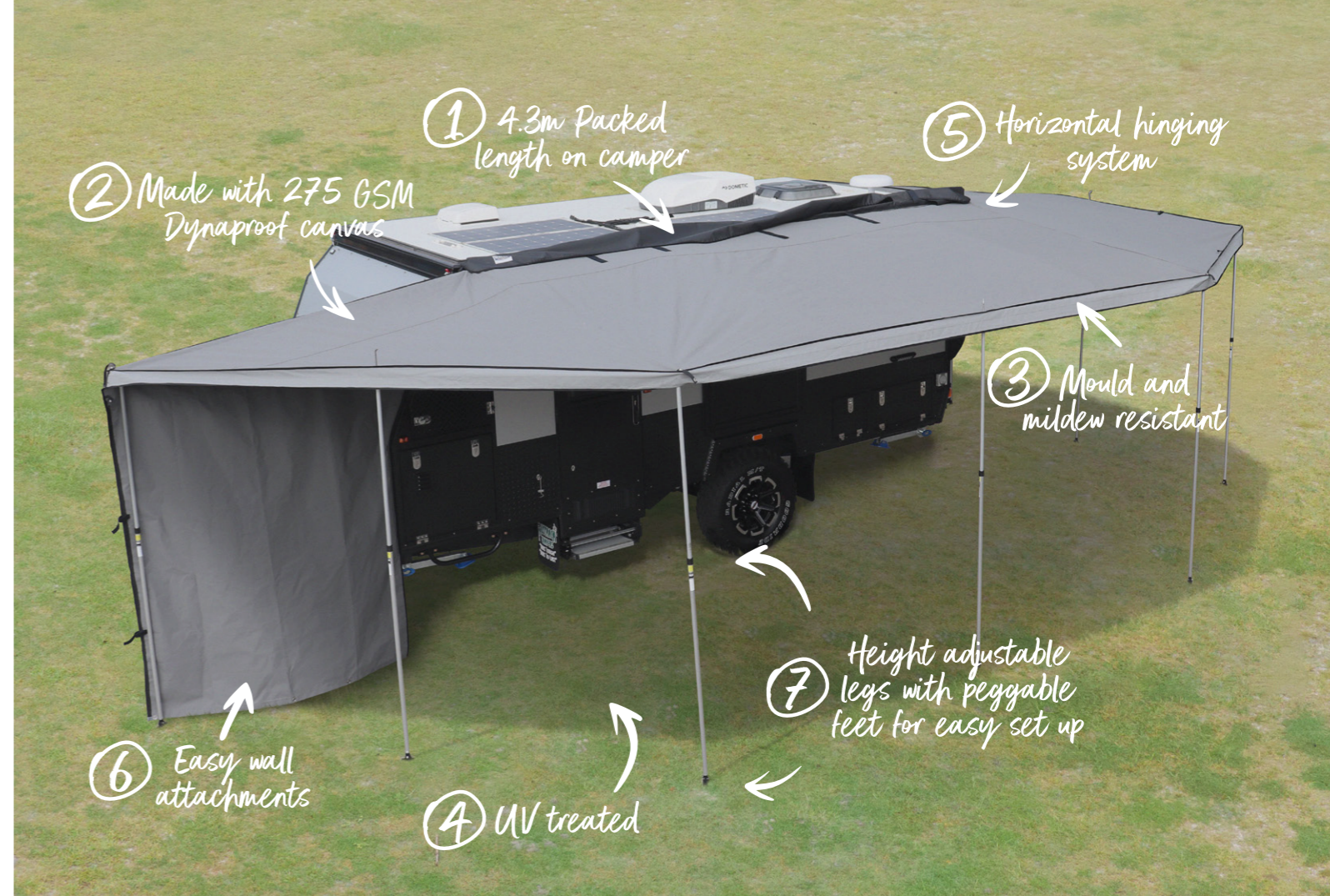
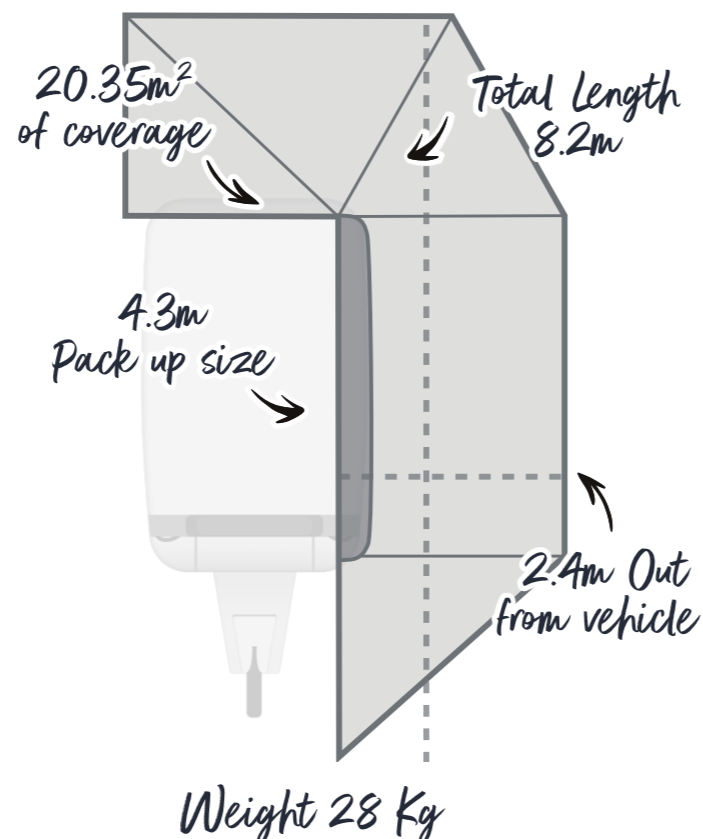

Features

- ① 4.3m packed length on camper
- ② Made with Australian Made 275 GSM Dynaproof Canvas
- ③ Mould and mildew resistant
- ④ UV treated and tested for Australian conditions
- ⑤ Horizontal hinging system for low profile and better clearance
- ⑥ Easy wall attachment for all five sides
- ⑦ 2.1m height adjustable legs with peggable feet for quick and easy setup
- ⑧ Includes mounting brackets that suit most vehicles



COMPARISON TABLE



	 SUPA WING	 RAPID WING 6	 RAPID WING 4	 180° WING	 STAND EASY ERV
Coverage / m ²	20.35 m ²	17 m ²	10.8 m ²	8.2 m ²	6.25 m ²
Weight	28 kg	21.2 kg	15.5 kg	14 kg	11 kg
Pack Up Length	4.3 m	2.5 m	2.5 m	2.2 m	2.6 m
Set Up Length	8.2 m	7.4 m	4.7 m	6.1 m	2.5 m
Max Height	2.1 m	2.1 m	2.1 m	2.1 m	2.1 m
Out From Vehicle	2.4 m	2.2 m	2.2 m	2 m	2.5 m
Optional Walls	1-5	1-5	1-4	1-3	1-3
Australian Made	✓	✓	✓	✓	✓



ABOUT OUTBOUND

Supa Peg is one of Australia's largest, manufacturers and wholesalers of camping good and accessories. Our products are designed in Australia for Australian conditions. The majority of our products are manufactured at our factory in Yatala QLD. We have developed a reputation of innovation, design and quality that others try to copy.

We manufacture a wide range of camping accessories such as awnings, poles, pegs, ropes and other handy camping equipment for, 4WDs, caravanning, camper trailers, camper vans, RV, trailers and other outdoor recreation vehicles.

If you are a regular camper, on the road all the time or just want a quality awning that will last the distance, this is the ideal awning for you. Backed by an Australian warranty and local Australian support, these awnings are guaranteed to give you the best experience.

OUTBOUND

SUPAPEG
OUTDOOR GEAR CO.

(07) 3804 5544 SUPAPEG.COM.AU