

INAPOD

Office Pod Series 2

Engineered using an Advanced HEPA Filter

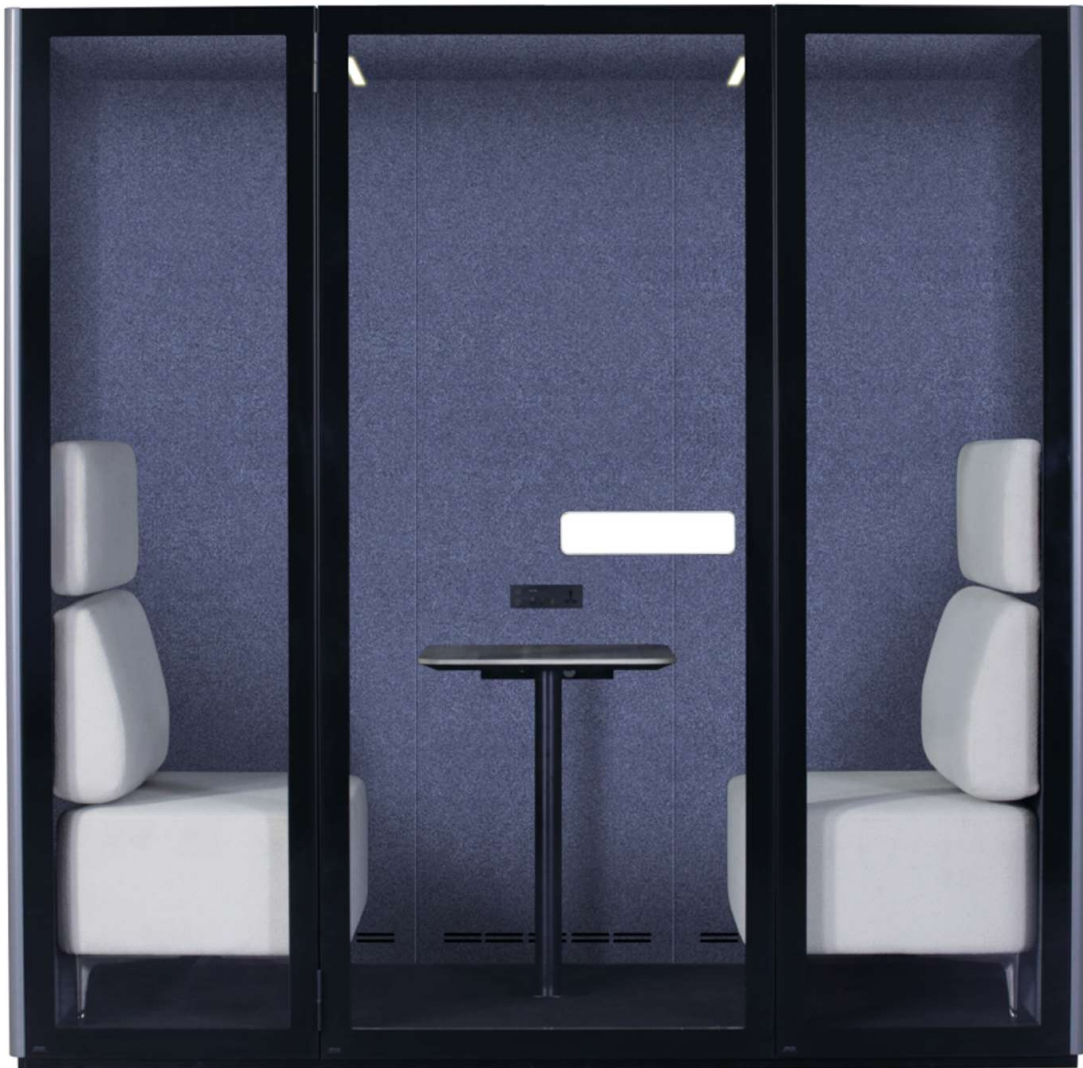

———— OFFICE POD SERIES 2 ————

INAPOD

Comfortable & Breathable

Advanced air purifying using a HEPA Filter

Inapod Series 2 utilizes the best air ventilation and purifying technology to provide consumers a healthy breathing environment at work.

The HEPA Filter captures airborne particles to cleanse entering air and enhance air quality and lessens allergic responses.

The filtered air has been tested to the ISO 14644-1:2015 Standard.

HEPA Filters are used in applications that require contamination control such as in hospitals, offices, pharmaceutical products and defence industries.

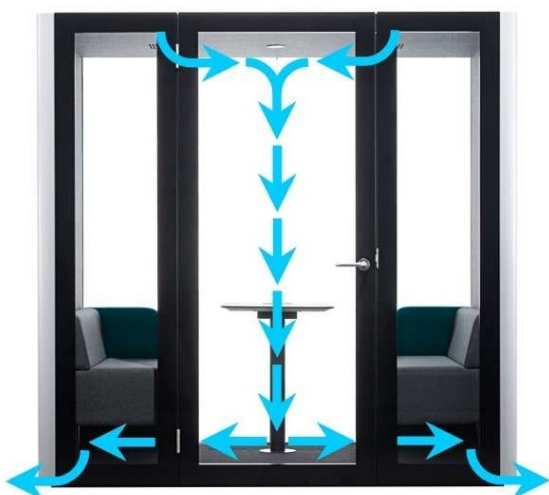
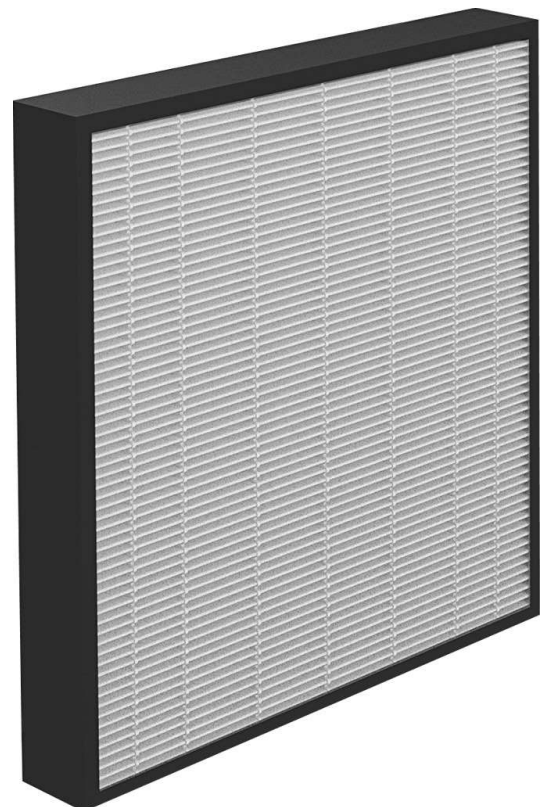
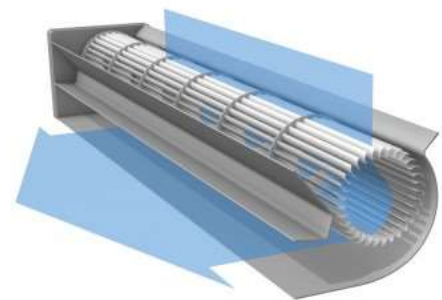
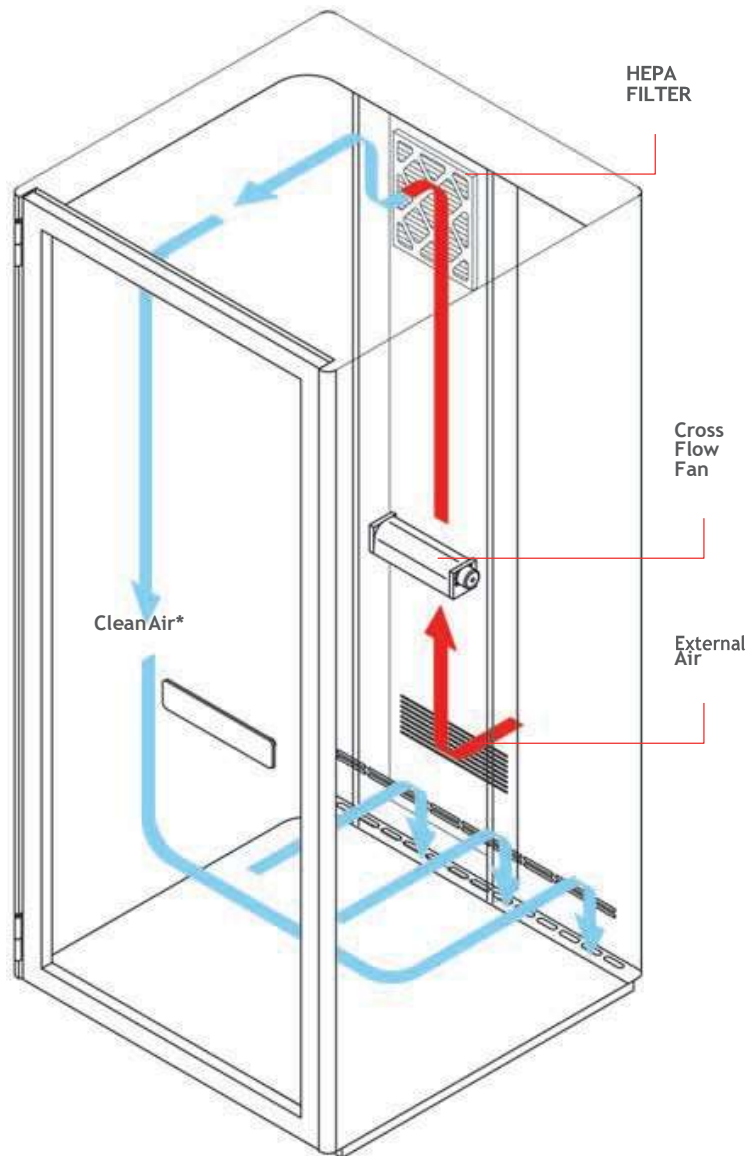

INAPOD



5 sizes available with different configurations

Inapod has become a popular office furniture product in the Australian & Global market. Series 2 offers a new experience for the workplace. A serene, comfortable and practical solution to improve work efficiency.

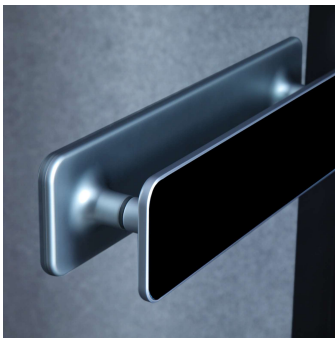

New elegant door handle



Ergonomic & exclusive charging ports

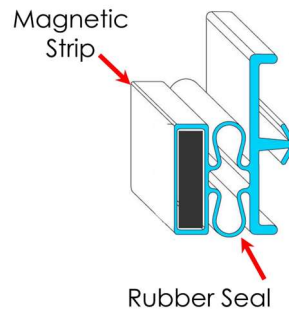

Magnetic self closing rubber door seal technology



Motion sensor for energy saving

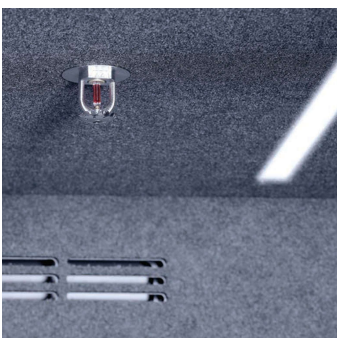

Air inlet in the ceiling

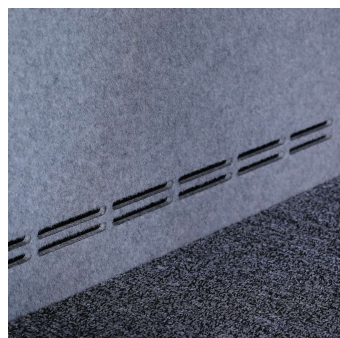

Air outlet near the floor



Knockout hole for sprinkler



Greenguard Certified

Redefine your working space

Series 2 - S POD

Exterior Size 1000 x 1000 x 2180h

- HEPA Filter - Standard
- Magnetic self closing rubber door seal technology
- Automatic self closing door
- UL Greenguard certified



Stool not included



1 Person

INAPOD

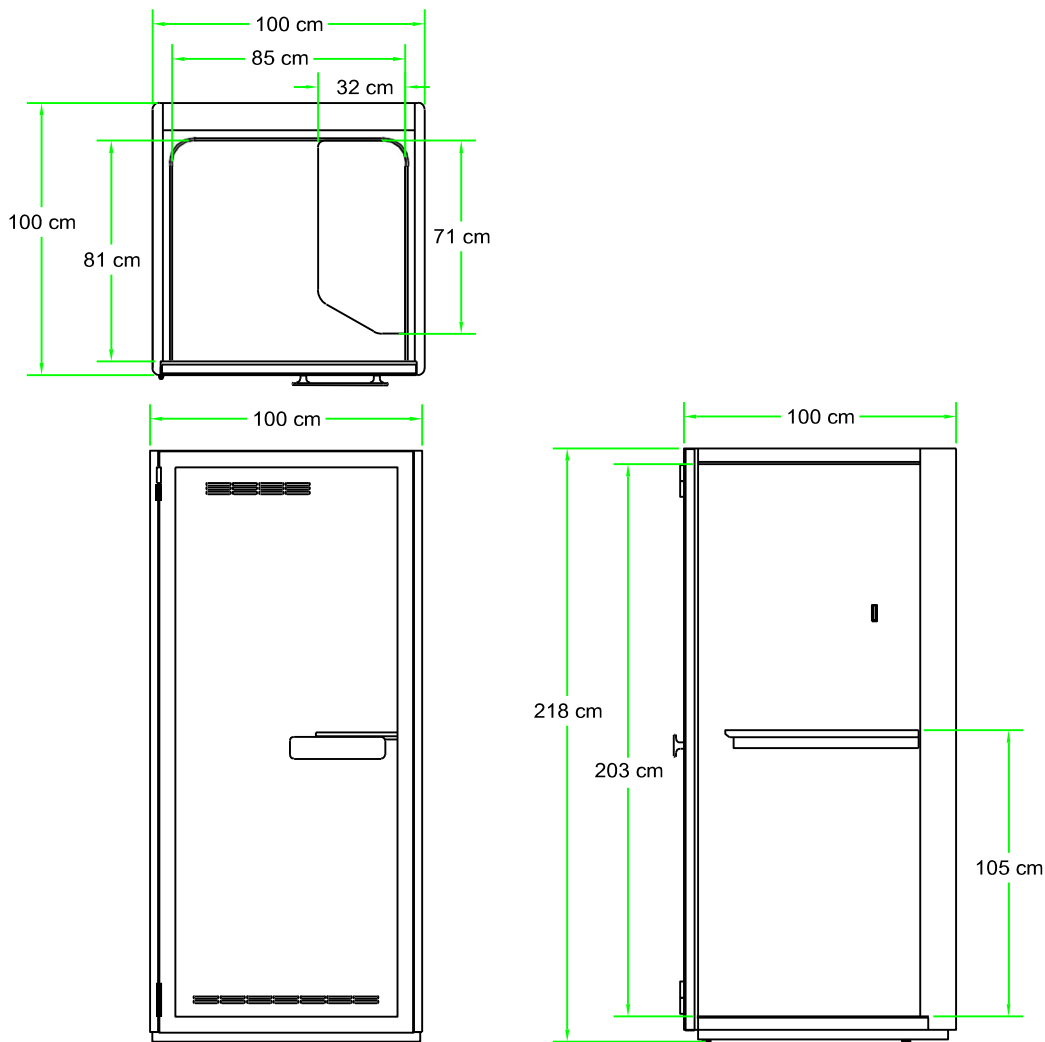

SERIES 2 - S POD - Single person office pod

The **Series 2 S POD** is a classic pod for a single person. In the serene space, an individual can carry out work that requires a high level of privacy such as making phone calls and video conferencing.

Power and connectivity are seamless, with continuous power supply for your gadgets and direct connection to your office network.

Technical Specifications

- **Airflow** **Advanced air purification with HEPA filtration - 1 Set of HEPA filters.** Electric Cross flow fans- 81 air changes per hour
- **Shelf Size** 710 x 320 x 25mm
- **Auto Door** Automatic self closing door
- **Door Seal** Magnetic self closing rubber door seal technology
- **Handle** Redesigned elegant front handle
- **Sprinkler** Provision for a fire sprinkler head if required with a knock out hole in the ceiling
- **Door** 10mm double laminated glass door
- **Outlets** A/C power, USB-Type A, USB-Type C & Cat 6 charging ports
- **Lighting** 18W 12Vdc recessed LED strip with dimmer
- **Acoustics** High acoustic rating - beautifully designed using carefully selected materials with the best absorption & isolation performance. Weighted Level Difference 28.3dB
- **Exterior Materials** Structural strength wall detail: Electro galvanised 1.2mm thick steel - All structural steel construction
- **Interior Materials** Fire rated and tested fabric materials - electro galvanized 1.2mm thick steel with fire rated acoustic board
- **Fire tests** Fire Rating: Acoustic Board, Carpet and Polyester Foam Fire Rated. Conforms to all Australian & overseas Fire tests
- **Environment** UL Greengard certified
- **Mobility** Optional castors are an add on feature for S-Pod
- **Lockable** Electric lockable door accessed by Q-code and app. (Option)
- **Power** Power is connected using a standard wall mounted 240V GPO
- **Sensor** All power functions are activated by an energy saving motion sensor with auto turn off after 5 minutes of inactivity
- **Weight** 278kg

Designed with space and quiet

Series 2 - D POD

Exterior Size 2200 x 1250 x 2180h

- HEPA Filter - Standard
- Magnetic self closing rubber door seal technology
- Automatic self closing door
- UL Greenguard certified



1 - 4 Person

INAPOD

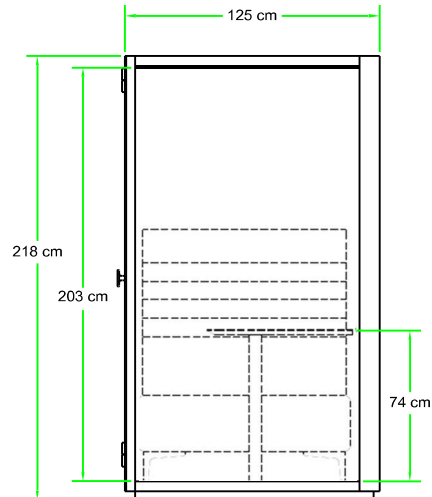
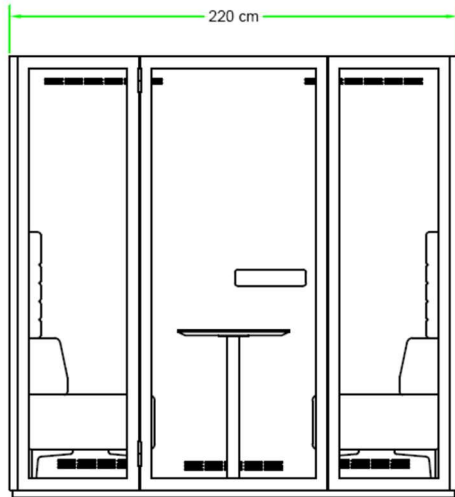
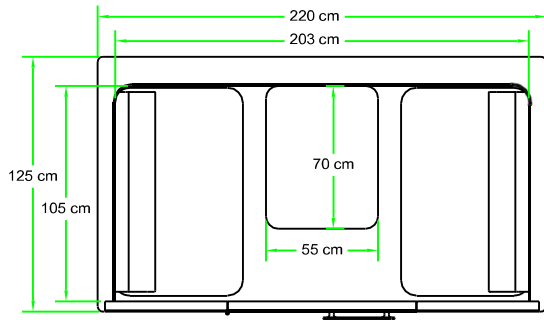

SERIES 2 - D POD - 1-4 person office pod

The **Series 2 D POD** is perfect for holding zoom meetings, brainstorming sessions, one-on-one conversations, as well as to rest & rejuvenate from the disturbance of a busy and noisy office.

Power and connectivity are seamless, with continuous power supply for your gadgets and direct connection to your office network.

Technical Specifications

- **Airflow** **Advanced air purification with HEPA filtration - 2 Set of HEPA filters.** Electric Cross flow fans- 59 air changes per hour
- **Shelf Size** 700 x 550 x 25mm
- **Auto Door** Automatic self closing door
- **Door Seal** Magnetic self closing rubber door seal technology
- **Handle** Redesigned elegant front handle
- **Sprinkler** Provision for a fire sprinkler head if required with a knock out hole in the ceiling
- **Door** 10mm double laminated glass door
- **Outlets** A/C power, USB-Type A, USB-Type C & Cat 6 charging ports
- **Lighting** 18W 12Vdc recessed LED strip with dimmer
- **Acoustics** High acoustic rating - beautifully designed using carefully selected materials with the best absorption & isolation performance. Weighted Level Difference 28.3dB
- **Exterior Materials** Structural strength wall detail: Electro galvanised 1.2mm thick steel - All structural steel construction
- **Interior Materials** Fire rated and tested fabric materials - electro galvanized 1.2mm thick steel with fire rated acoustic board
- **Fire tests** Fire Rating: Acoustic Board, Carpet and Polyester Foam Fire Rated. Conforms to all Australian & overseas Fire tests
- **Environment** UL Greengard certified
- **Mobility** Optional castors are an add on feature for D-Pod
- **Lockable** Electric lockable door accessed by Q-code and app. (Option)
- **Power** Power is connected using a standard wall mounted 240V GPO
- **Sensor** All power functions are activated by an energy saving motion sensor with auto turn off after 5 minutes of inactivity
- **Weight** 532kg

Designed with ingenuity

Series 2 - W POD

Exterior Size 1400 x 1250 x 2180h

- HEPA Filter - Standard
- Magnetic self closing rubber door seal technology
- Automatic self closing door
- UL Greenguard certified

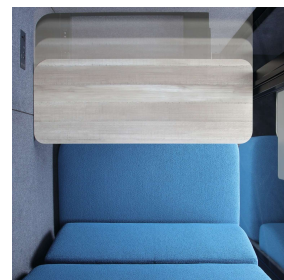
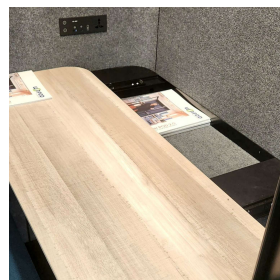
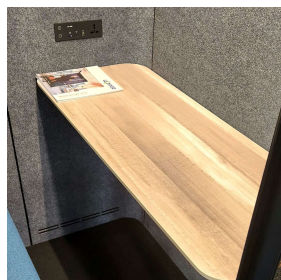
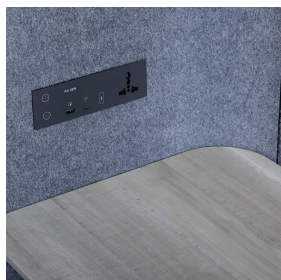

1 Person

INAPOD

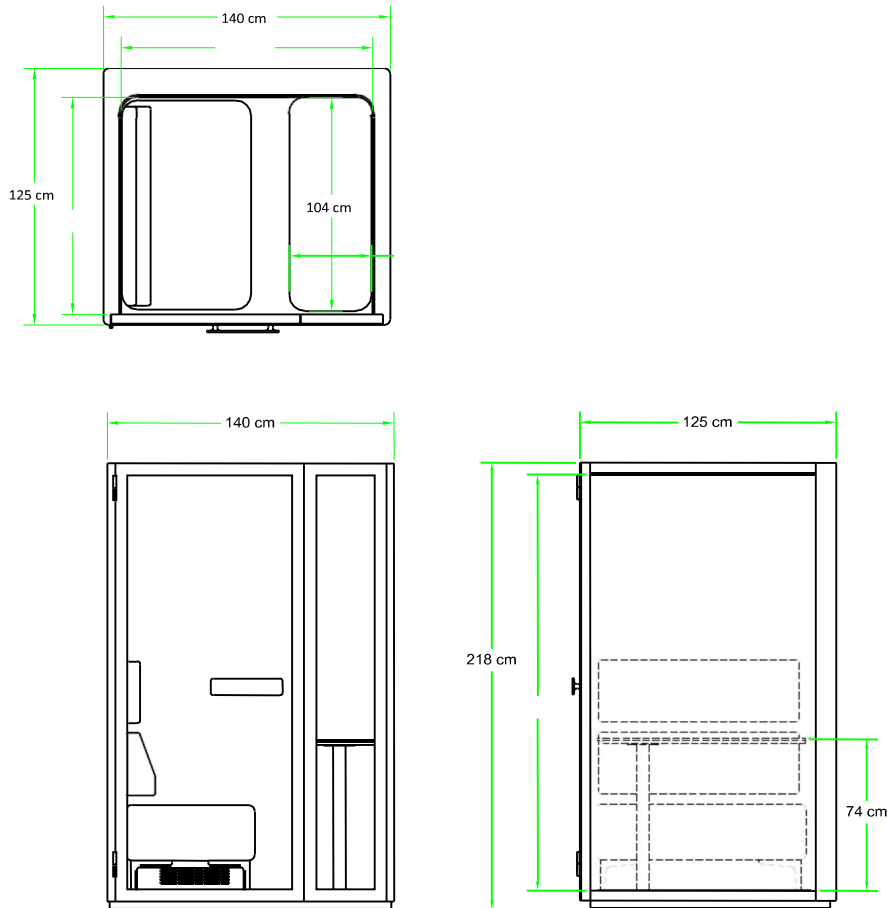

SERIES 2 - W POD - 1 person work/zoom room

The **Series 2 W POD** has a unique extendable desktop with multiple functions. This ergonomic feature allows you to adjust your working position, while providing a storage space.

This spacious pod is suitable for an individual who wants to work over a long period of time.

Power and connectivity are seamless, with continuous power supply for your gadgets and direct connection to your office network. The desktop provides space for a laptop or a screen can be mounted on the wall above.

Technical Specifications

- **Airflow** **Advanced air purification with HEPA filtration - 1 Set of HEPA filters.** Electric Cross flow fans- 37 air changes per hour
- **Shelf Size** Pull out desk with storage underneath 1040 x 400 x 25mm
- **Auto Door** Automatic self closing door
- **Door Seal** Magnetic self closing rubber door seal technology
- **Handle** Redesigned elegant front handle
- **Sprinkler** Provision for a fire sprinkler head if required with a knock out hole in the ceiling
- **Door** 10mm double laminated glass door
- **Outlets** A/C power, USB-Type A, USB-Type C & Cat 6 charging ports
- **Lighting** 18W 12Vdc recessed LED strip with dimmer
- **Acoustics** High acoustic rating - beautifully designed using carefully selected materials with the best absorption & isolation performance. Weighted Level Difference 28.3dB
- **Exterior Materials** Structural strength wall detail: Electro galvanised 1.2mm thick steel - All structural steel construction
- **Interior Materials** Fire rated and tested fabric materials - electro galvanized 1.2mm thick steel with fire rated acoustic board
- **Fire tests** Fire Rating: Acoustic Board, Carpet and Polyester Foam Fire Rated. Conforms to all Australian & overseas Fire tests
- **Environment** UL Greengard certified
- **Mobility** Optional castors are an add on feature for W-Pod
- **Lockable** Electric lockable door accessed by Q-code and app. (Option)
- **Power** Power is connected using a standard wall mounted 240V GPO
- **Sensor** All power functions are activated by an energy saving motion sensor with auto turn off after 5 minutes of inactivity
- **Weight** 405kg

Maximum focus & minimal distraction

Series 2 - C POD

Exterior Size 2400 x 2400 x 2180h

- HEPA Filter - Standard
- Magnetic self closing rubber door seal technology
- Automatic self closing door
- UL Greenguard certified



Bare Pod



"L" Lounge Pod



Meeting Pod

3 configurations available



1 - 5 Person

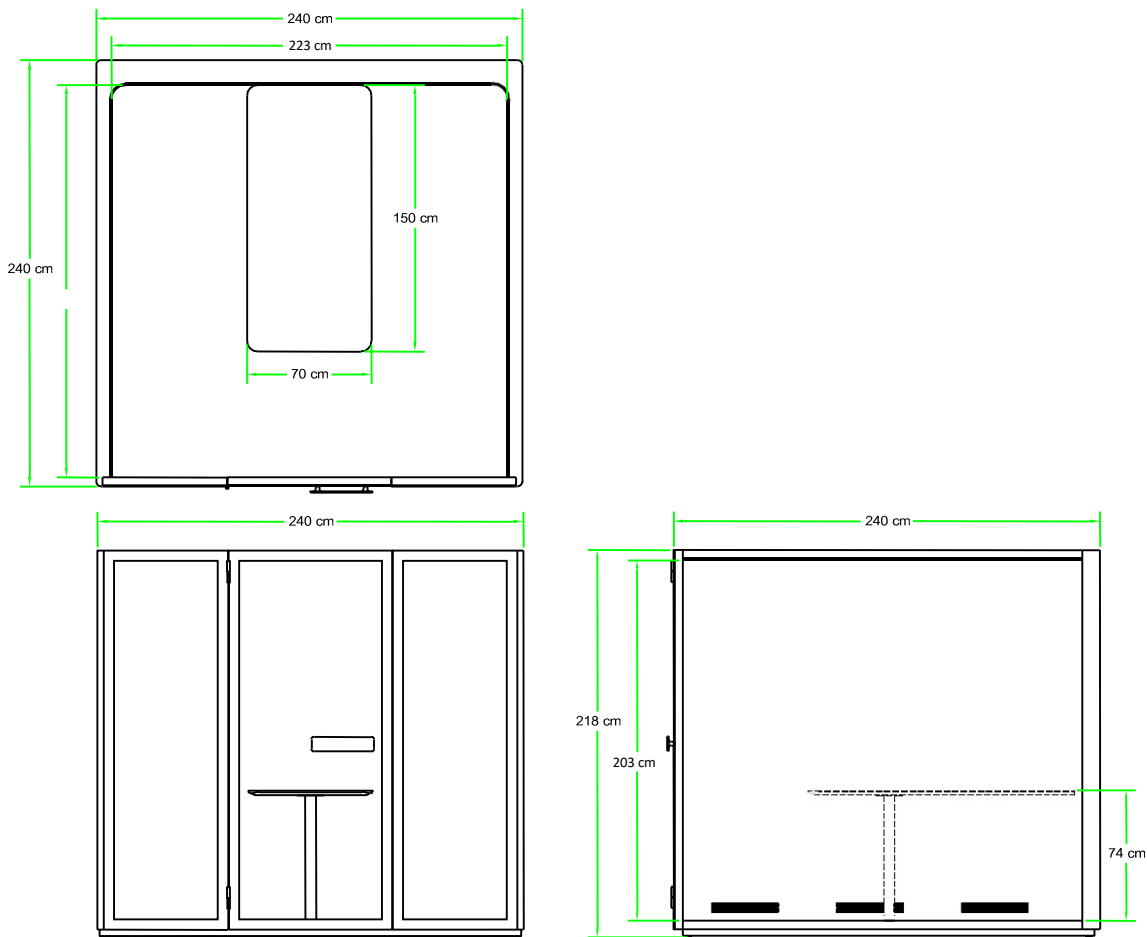

SERIES 2 - C POD - 1— 5 person meeting room

The **Series 2 C POD** is designed to fit up to 5 people, ideally for meeting, working or reworking. The C-POD is perfect for discussion, brainstorming and Zoom calls.

3 selections of furnishing layout are available, (A) Bare Unit, (B) L-Shaped Sofa & (C) Meeting Table with integrated charging ports. A video screen can be mounted on the wall above.

Power and connectivity are seamless, with continuous power supply for your gadgets and direct connection to your office network. The desktop provides space for a laptop or a screen can be mounted on the wall above.

Technical Specifications

- **Airflow** **Advanced air purification with HEPA filtration - 3 Sets of HEPA filters.** Electric Cross flow fans- 43 air changes per hour
- **DDA Access** Inapod Access pods are available to comply with AS 1428.1 Design for Access & Mobility
- **Meeting Pod** Boardroom table size 1600 x 750 x 25mm
- **'L' Lounge Pod** A 'L' shaped sofa is available for this model
- **Auto Door** Automatic self closing door
- **Door Seal** Magnetic self closing rubber door seal technology
- **Handle** Redesigned elegant front handle
- **Sprinkler** Provision for a fire sprinkler head if required with a knock out hole in the ceiling
- **Door** 10mm double laminated glass door
- **Outlets** **Bare Pod** = 2 x A/C power, 1 x USB-Type C & Cat 6 charging ports
Meeting Pod = 2 x A/C power, 1 x USB-Type A & Cat 6 + HDMI & Audio Jack
Sofa Pod = 2 x A/C power & 1 x USB-Type C
- **Lighting** 18W 12Vdc recessed LED strip with dimmer
- **Acoustics** High acoustic rating - beautifully designed using carefully selected materials with the best absorption & isolation performance. Weighted Level Difference 28.3dB
- **Exterior Materials** Structural strength wall detail: Electro galvanised 1.2mm thick steel - All structural steel construction
- **Interior Materials** Fire rated and tested fabric materials - electro galvanized 1.2mm thick steel with fire rated acoustic board
- **Fire tests** Fire Rating: Acoustic Board, Carpet and Polyester Foam Fire Rated. Conforms to all Australian & overseas Fire tests
- **Sensor** All power functions are activated by an energy saving motion sensor with auto turn off after 5 minutes of inactivity
- **Environment** UL Greengard certified
- **Mobility** Nil
- **Lockable** Electric lockable door accessed by Q-code and app. (Option)
- **Power** Power is connected using a standard wall mounted 240V GPO
- **Weight** 703kg

Crafted to perfection

Series 2 - M POD

Exterior Size 3000 (4000 & 5000) x 2400 x 2180h

- HEPA Filter - Standard
- Magnetic self closing rubber door seal technology
- Automatic self closing door
- UL Greenguard certified



Bare Pod



"L" Shaped Lounge Pod



Meeting Pod



INAPOD

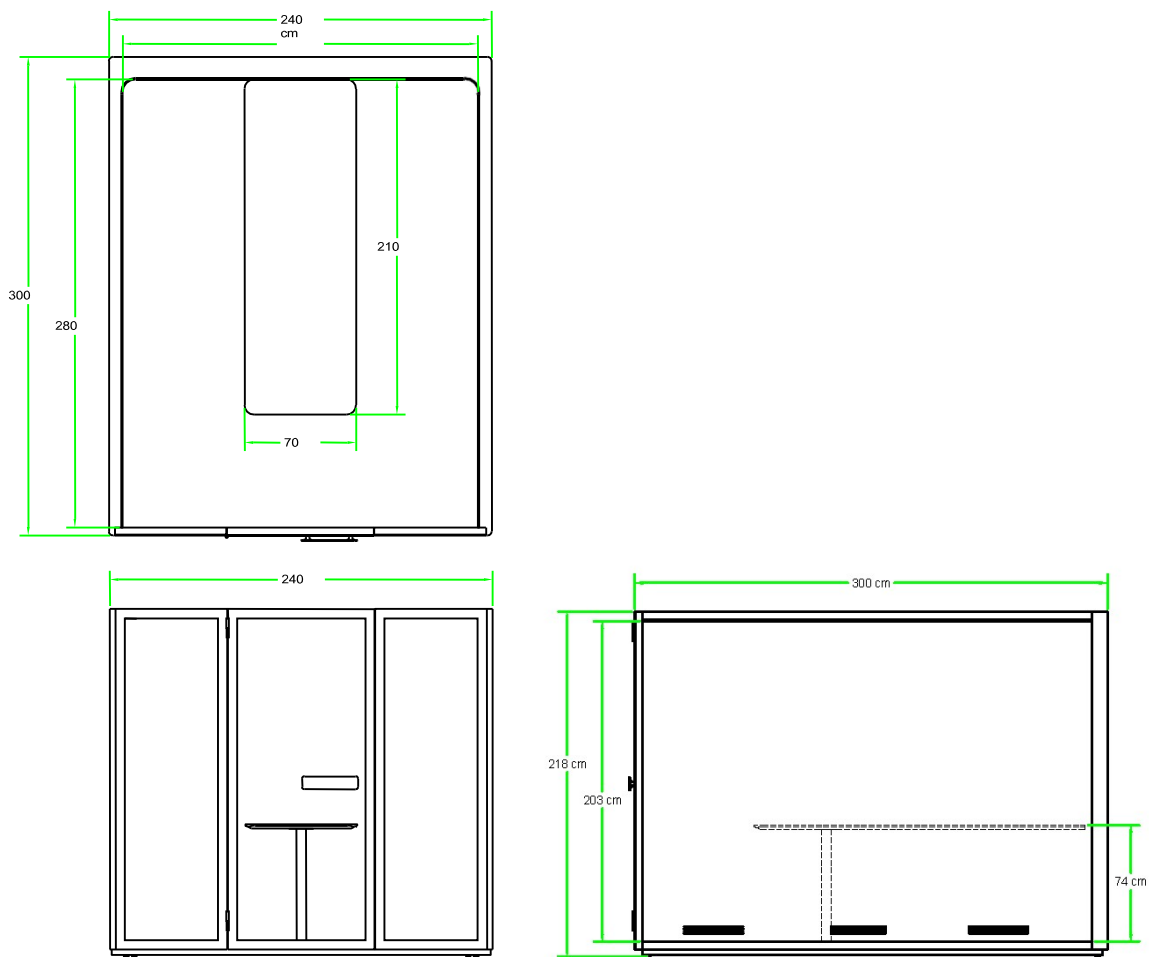

SERIES 2 - M POD - 1– 7 person meeting room

The **Series 2 M POD** is designed to fit up to 7 people. It's comfortable and well-ventilated space can help users to increase work efficiency and productivity.

3 selections of furnishing layout are available, (A) Bare Unit, (B) L-Shaped Sofa & (C) Meeting Table with integrated charging ports. A video screen can be mounted on the wall above.

Power and connectivity are seamless, with continuous power supply for your gadgets and direct connection to your office network. The desktop provides space for a laptop or a screen can be mounted on the wall above.

Technical Specifications

- **Airflow** **Advanced air purification with HEPA filtration - 3 Sets of HEPA filters.** Electric Cross flow fans– 31 air changes per hour
- **DDA Access** Inapod Access pods are available to comply with AS 1428.1 Design for Access & Mobility
- **Meeting Pod** Boardroom table size 2200 x 750 x 25mm
- **'L' Lounge Pod** A 'L' shaped sofa is available for this model
- **Auto Door** Automatic self closing door
- **Door Seal** Magnetic self closing rubber door seal technology
- **Handle** Redesigned elegant front handle
- **Sprinkler** Provision for a fire sprinkler head if required with a knock out hole in the ceiling
- **Door** 10mm double laminated glass door
- **Outlets** **Bare Pod** = 2 x A/C power, 1 x USB-Type C & Cat 6 charging ports
Meeting Pod = 2 x A/C power, 1 x USB-Type A & Cat 6 + HDMI & Audio Jack
Sofa Pod = 2 x A/C power & 1 x USB-Type C
- **Lighting** 18W 12Vdc recessed LED strip with dimmer
- **Acoustics** High acoustic rating - beautifully designed using carefully selected materials with the best absorption & isolation performance. Weighted Level Difference 28.3dB
- **Exterior Materials** Structural strength wall detail: Electro galvanised 1.2mm thick steel - All structural steel construction
- **Interior Materials** Fire rated and tested fabric materials - electro galvanized 1.2mm thick steel with fire rated acoustic board
- **Fire tests** Fire Rating: Acoustic Board, Carpet and Polyester Foam Fire Rated. Conforms to all Australian & overseas Fire tests
- **Sensor** All power functions are activated by an energy saving motion sensor with auto turn off after 5 minutes of inactivity
- **Environment** UL Greengard certified
- **Mobility** Nil
- **Lockable** Electric lockable door accessed by Q-code and app. (Option)
- **Power** Power is connected using a standard wall mounted 240V GPO
- **Weight** 967kg

Applications

INPOD is designed to accommodate you...

For use in (but not limited to) the following installations:

- Banking
- Open Plan Office/Workplace
- Co-Working Spaces
- Architects, & Interior Designers
- Recording studios
- Restaurants
- Home use
- Mining
- University
- Federal, State & Local Government
- Commercial
- Café's and restaurants
- Hotels and accommodation,
- Solicitors
- Courtrooms
- Finance and Insurance
- Arts and entertainment
- Business services & Marketing
- Education & Training
- Finance & Insurance
- Manufacturing & Industrial
- Organisations Public & Private
- Professional Services
- Property & Construction
- Security installations
- Top secret Spy Agencies
- Hospitals and nursing homes
- Department stores
- Defence Agencies
- Churches



Podcasting
Webinar
Recording
Broadcasting
Voice Over



INPOD is designed to accommodate your needs ...

The INAPOD range of PODS are perfect for a variety of applications, both commercial and residential.

The unique modular design and a variety of sizes provide you with maximum flexibility.

So no matter what your use might be, we have a model to suit.

Features

HEPA FILTER - Air purifying system with advanced HEPA filter on all models

AUTO CLOSING DOOR - The door closes automatically after the user has left the unit

MAGNETIC RUBBER DOOR TECHNOLOGY - Soft closing door using a rubber door seal with a magnetic strip inside

ALL METAL CONSTRUCTION - Exterior shell and frame are made from strong metal construction

HIGH ACOUSTIC RATING - Beautifully designed using carefully selected materials with the best absorption and isolation performance. Weighted Level Difference 28.3dB

LED LIGHTING - These automatic LED lights allow for ample internal lighting

POWER & USB CHARGING OUTLETS - Continuous power supply for your gadgets and direct connection to your office network with internal outlets

FIRE, FLAMMABILITY AND SMOKE RATING—The **INAPOD** has been extensively tested to all the relevant Standards

10mm DOUBLE LAMINATED GLASS - The 10mm laminated glass provide excellent attenuation for a perfectly silent and isolated work environment, yet still provides inclusivity via transparent glass

LAMINATED WORKTOP OR WORKING TABLE - In the **S POD** there is a laminated worktop big enough for your laptop, and in the **D POD** there is a large working table in the center of the POD. **W POD** has a unique extendable desktop with storage space, and desk options are available for **C POD** and **M POD**.

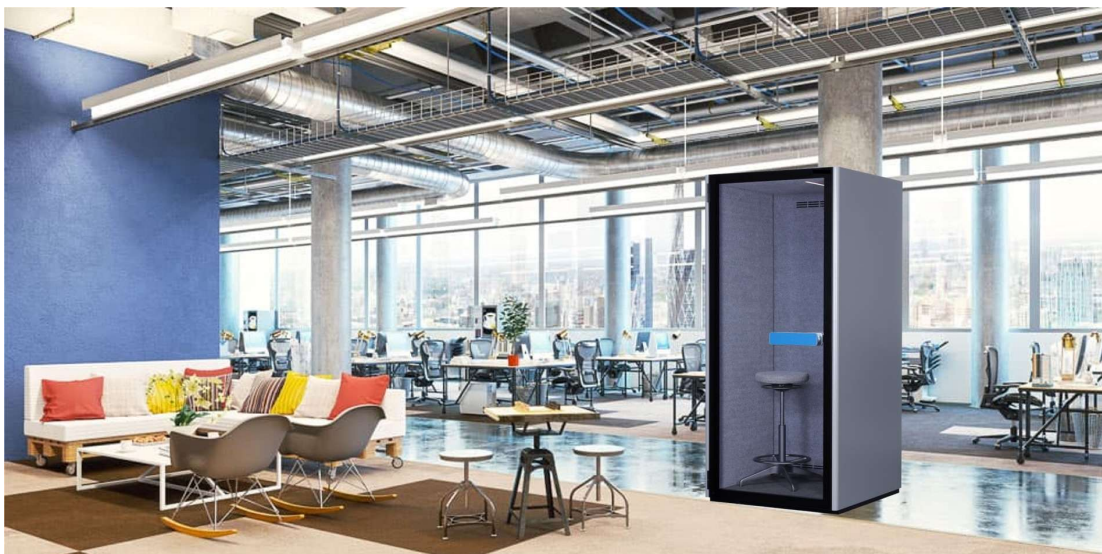

Features continued

POWER TO WALL SOCKET - Standard 240V wall plug/socket connection.

COMFORTABLE & BREATHABLE - Work comfortably in a well ventilated space with great acoustic properties.

MOTION SENSOR - The motion sensor detects movement and turns on the fans and lights automatically making the unit extremely energy efficient.

RETRACTABLE & PORTABLE - It is designed to be easily dismantled, moved and re-installed. Optional integrated castors allow for ease of movement when required (S, D & W PODS only)

CAT6 OUTLET - The CAT6 outlet has been added for increased internet speed should it be required.

WIRELESS DIMMER - Light dimmer system allowing for lowering the light intensity for teleconference calls and presentations. Wi-Fi connection to the receiver.

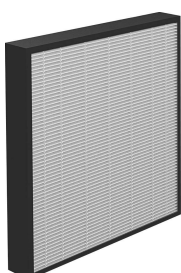
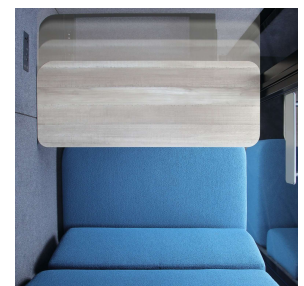
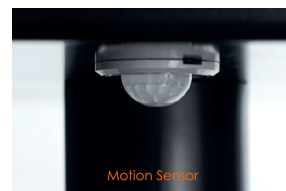
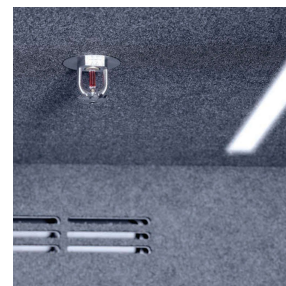
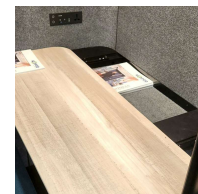
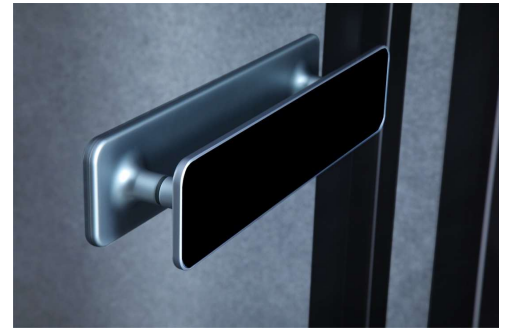

Acoustics

HIGH ACOUSTIC RATING - Beautifully designed and using carefully selected materials with the best absorption and isolation performance. Weighted Level Difference 28.3dB

Independently tested by TUV SUD Group, the INAPOD range of Office/Acoustic Booths feature all metal construction and sound proofing walls with 10mm dual laminated glass walls and doors.

All joints are sealed using rubber sound absorbing extrusions to seal as much noise as possible for the user inside the Pod.

Polyester Fabric Acoustic Board is used inside the unit with Fabric Nylon Carpet on the floors.





Standards/Testing

INAPOD TEST REPORTS

- **INAPOD– Tested to the following Fire Standards:**
 - Australian Standards AS 1530 Part 3
 - AS 1530 PART 3 (Acoustic Panels)
 - S/NZS 3837 (Wall & Ceiling lining)
 - AS ISO 9239 (Floor Coverings)
 - AS 5637 Group Number 3 (Wall & Ceiling Lining)
- **Universal Socket Outlet** Test report No. 7191140108-EEC16/PKS.
- **Flammability of the Polyester Fiber Acoustic Panel– BS 476 Part 7:1997+Amd.No.C1:2014** Fire Tests on Building Materials & Structures Part 7
- **ASTM E662 Smoke Density (Flaming) Standard Test** Method for Specific Optical Density of Smoke Generated by Solid Materials also referenced as NFPA 258
- **Flame Retardancy Test** for Flexible Polyurethane Foam and Fire Retardant Foam
- **Sound Testing:**
 - AS ISO140.4-2006 'Acoustics
 - AS ISO 717.1-2020 'Acoustics
- **Sound Testing:** ASTM E413-04 "Classification of Rating Sound Insulation.

Inapod Finishes

Colours that influences the soul

EXTERIOR

COLOUR SELECTION



Smoke White



Charcoal Black



Silver



Space Grey



Sky Blue



Lagoon Blue



Rose Pink



Dandelion Yellow

INTERIOR

ACOUSTIC SHEET COLOUR SELECTION



Light Grey



Charcoal Black

CARPET COLOUR SELECTION



Black



Silver (M POD Only)

SOFA

FABRIC COLOURSELECTION



1001
Oyster White



1002
Beige Grey



1003
Brown Grey



1006
Dark Grey



1007
Grey



1009
Brown



1011
Yellow



1014
Dark Green



1015
Blue



1016
Dark Blue



1020
Orange



1021
Purple



1022
Peach

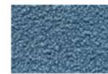

1023
Sky Blue



1026
Lemon Yellow



1027
Brown Red

*Display colours may slightly vary from the actual colours.

Australian and International Testing



Redefine your working space with Inapod Series 2

inapod.com.au

© 2023 [INAPOD](https://inapod.com.au). Copyright Office Portfolio 2023 Patents and Certified Design Registrations in Australia & New Zealand. 'INAPOD' is a Registered Trademark in Australia. All rights reserved. Office Portfolio are the Exclusive Distribution Agents in Australia.