

**AIFOL**®

**Product Manual**

**[ AIFOL  
LIFE  
RICH ]**

Freestanding Acrylic Bathtub

Model:BT-FB-1385

Freestanding Bathtub

Top

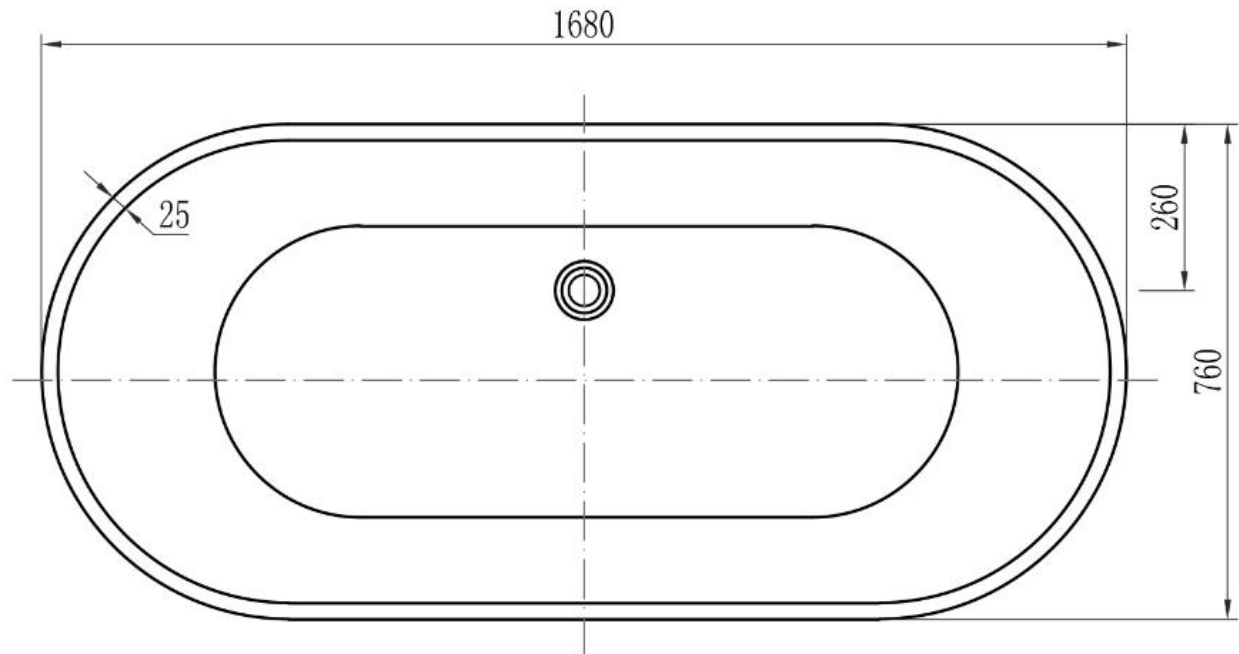

Front

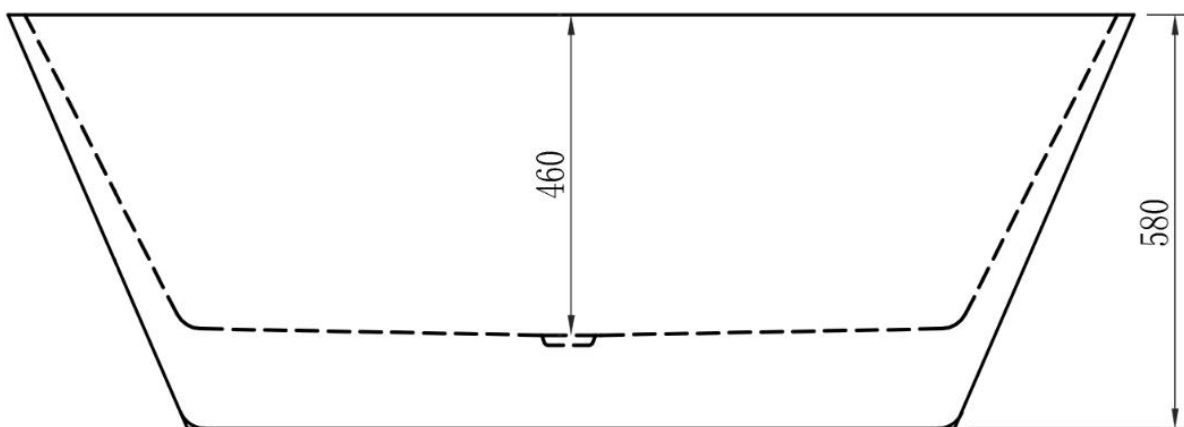

**READ ALL INSTRUCTIONS BEFORE UNPACKING THE PRODUCT!**

**INSTRUCTIONS THAT, IF IGNORED COULD RESULT IN DEATH OR SERIOUS INJURY CAUSED BY INCORRECT HANDLING OR INSTALLATION OF THE PRODUCT. THESE INSTRUCTIONS MUST BE OBSERVED FOR SAFE INSTALLATION.**



NOTICE: Do not change or modify the product in any way. Doing so may compromise the products structural integrity and will void the warranty.

NOTICE: Installation instructions must be followed. Any diversions from the installations may risk property damage and will void the warranty.

NOTICE: When moving your tub, be sure to lift, never slide or pull, doing so may result in damage to the product or the surrounding area.

NOTICE: If you are unfamiliar with tub installation please consult a professional.

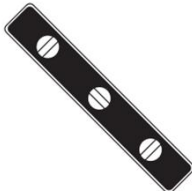
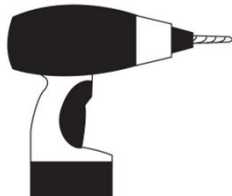
**TOOLS:**

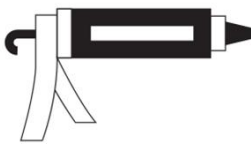
 <p>PENCIL</p>	 <p>LEVEL</p>	 <p>DRILL</p>	<p><b>PLUS:</b>            FABRIC CLOTH TO PROTECT THE BATH AND CONVENTIONAL WORKSHOP TOOLS.            PLUMBER' S TAPE</p>
 <p>MEASURING TAPE</p>	 <p>ADJUSTABLE KEY</p>	 <p>SILICONE</p>	

## PREPARE FOR INSTALLATION:

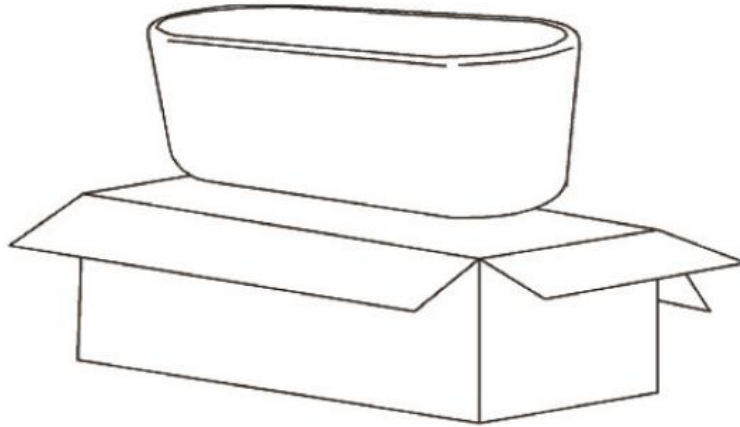

1. Remove the tub from the packaging and place on a soft cloth (it is recommended to have two people for this step).
2. Level the tub by turning it over and rotating the feet underneath (it is recommended to have two people for this step).

3. Fill the tub to the overflow and check for leaks. If the flex hose leaks at the drain/hose adapter, add plumber's tape to the drain threads and re-attach

4. Clean and prepare the floor where you will be installing the tub.

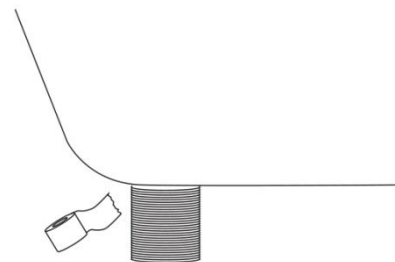

5. Place the tub in the exact position you will be installing it (it is recommended to have two people for this

6. Using a pencil, trace around the tub, marking the installation area.

## INSTALLATION:

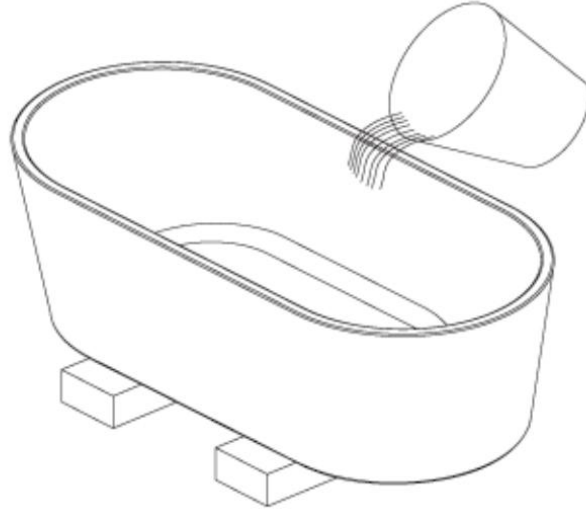

1. Determine the location of the drain pipe on the floor by measuring the drain and waste location under the tub. (This will vary on each tub)
2. Apply a bead of silicone or adhesive to the bottom tub supports.
3. Apply a bead of tub and tile caulk around the edge of the base.
4. Carefully set the tub in to position and connect the preinstalled drain flex hose to the tub.
5. Filling the tub again check for any leaks in waste connections below. (access below the floor will be necessary)
6. Apply a final bead of silicone around the bottom edge of the tub where it meets the floor and wipe away any excess.

## AIFOL INCLUDES HIGH QUALITY BATHTUB DRAIN& PIPE

Features: Anti-leakage Design and anti-odor Design

Bug cover design to ground drain pipe

Tough durable material, endure high temperature. Anti-aging, Anti-corrosion

No toxic environmental anti-crack in cold Weather

## IMPORTANT SAFETY RULES:

### ATTENTION! ALWAYS FOLLOW THESE PRECAUTIONS WHEN USING A BATHTUB

- ◆ Warning The bathtub must be installed and used as described in this manual
- ◆ Warning Use caution when entering or exiting the bathtub
- ◆ Warning Do not permit children or persons with infirmities to use the bathtub without supervision of an adult
- ◆ Warning People using any medications or having adverse medical history must consult a physician prior to use of the bathtub to avoid potential hyperthermia and possible drowning
- ◆ Warning Water temperature over 100°F may cause hyperthermia and/ or other health problems. Check water temperature and adjust it for your personal comfort
- ◆ Warning Never use bathtub while intoxicated, after taking meals or any alcoholic beverages. Consuming alcoholic beverages before or during bathing will cause drowsiness and may result in hyperthermia, loss of consciousness, or even drowning
- ◆ Warning If you are pregnant or you feel that you are may be pregnant, consult your doctor before using the bathtub
- ◆ Warning Never use any electrical devices such as hair dryer lamp telephone tv, radio or others within 5 feet of the bathtub
- ◆ Warning Do not overfill the bathtub before entering. Entering the bathtub when filled will cause overflow and slippery conditions. Use extreme caution when entering and exiting

## CARE AND CLEANING:

- ◆ Most dirt will wash off with mild soap and warm water
- ◆ For tough spots, use liquid dish washing soap or non-chlorine bleach
- ◆ Do not use abrasive material such steel wool or scouring pads to clean the acrylic surface
- ◆ Always test the cleaning solution on a small area before using it on the entire surface.
- ◆ Do not allow cleaning to soak on the acrylic surface.
- ◆ Rinse thoroughly with water immediately and wipe dry with soft cloth

## REPAIR AND MAINTENANCE:

- ◆ Use liquid polish compound such as Gel-Gloss Kitchen and Bath Polish(TM)to keep the original shine of acrylic surface
- ◆ Light scratches can be removed with polishing compound for automobiles
- ◆ For deeper scratches use wet sandpaper(1500 grit or higher). Always add water when sanding and lightly sand the area larger than the scratch in a circular motion to remove the scratches. Repeat until the scratch is removed. Use soft cloth and small amount of polishing compound to restore shine. repeat as needed until surface shine is restored

## IMPORTANT:

**DO NOT USE:** Abrasive cleaners such as: acid, ammonia, bleach, and similar solutions  
Use of such solutions may cause corrosion, finish peeling, and/or dull the surface

**DO NOT USE:** Abrasive sponges or cloth. Never use steel, wool, or wired brushes that will permanently scratch the surface

**Retain these installation instructions for future reference**

**For warranty information please check [www.aifol.net](http://www.aifol.net)**

**For customer service concerns or support please email:[support@aifeiling.com](mailto:support@aifeiling.com)**