



Product Manual



Sink Waste Trap

Model: BA-SWT-1522

Bottle Trap

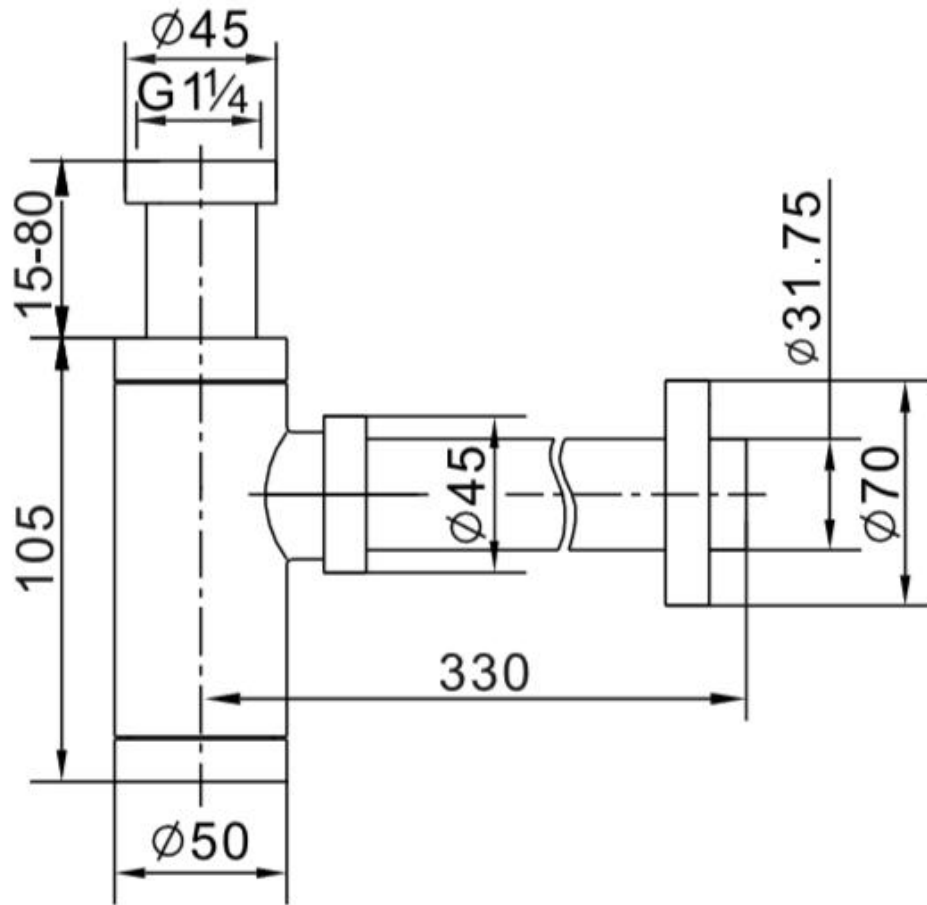

READ ALL INSTRUCTIONS BEFORE UNPACKING THE PRODUCT!

NOTICE: Observe all local plumbing and building codes.

NOTICE: This is a general installation guideline, actual installation may vary. Consult a professional if necessary.

NOTICE: Product drawings in this installation guide is for illustration purpose only. Actual product may vary by models

NOTICE: Read and understand this installation guide completely.

PREPARE FOR INSTALLATION:

Please check the image of the trap's detailed dimensions to make sure the trap fits for your basin or sink.

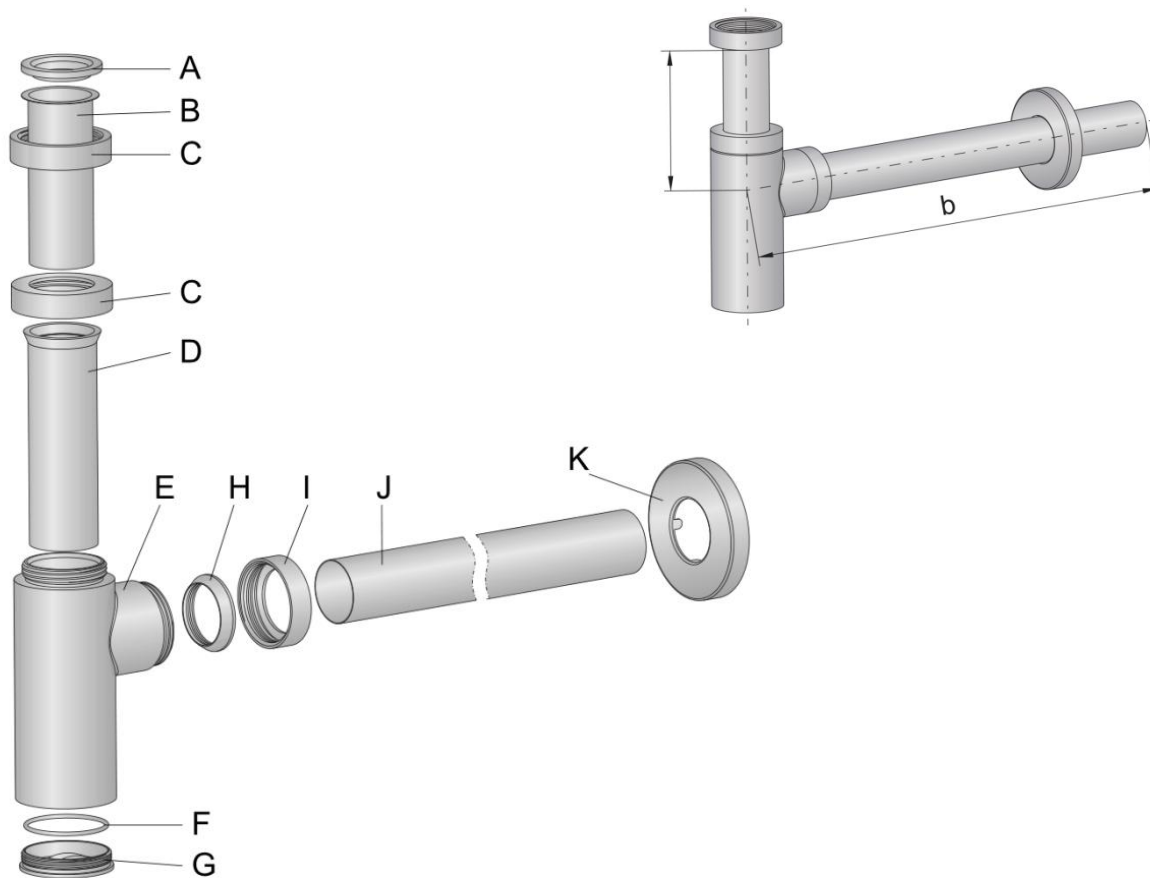
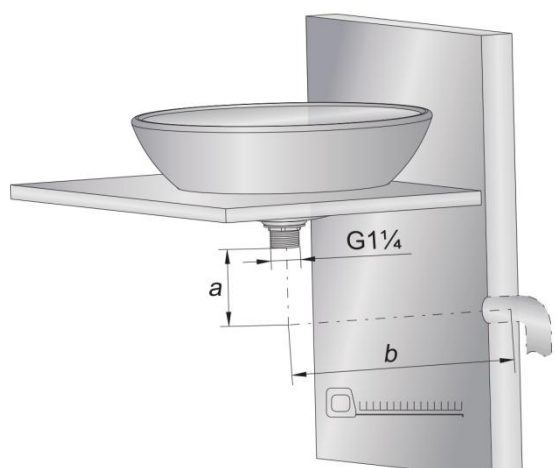

INSTALLATION:

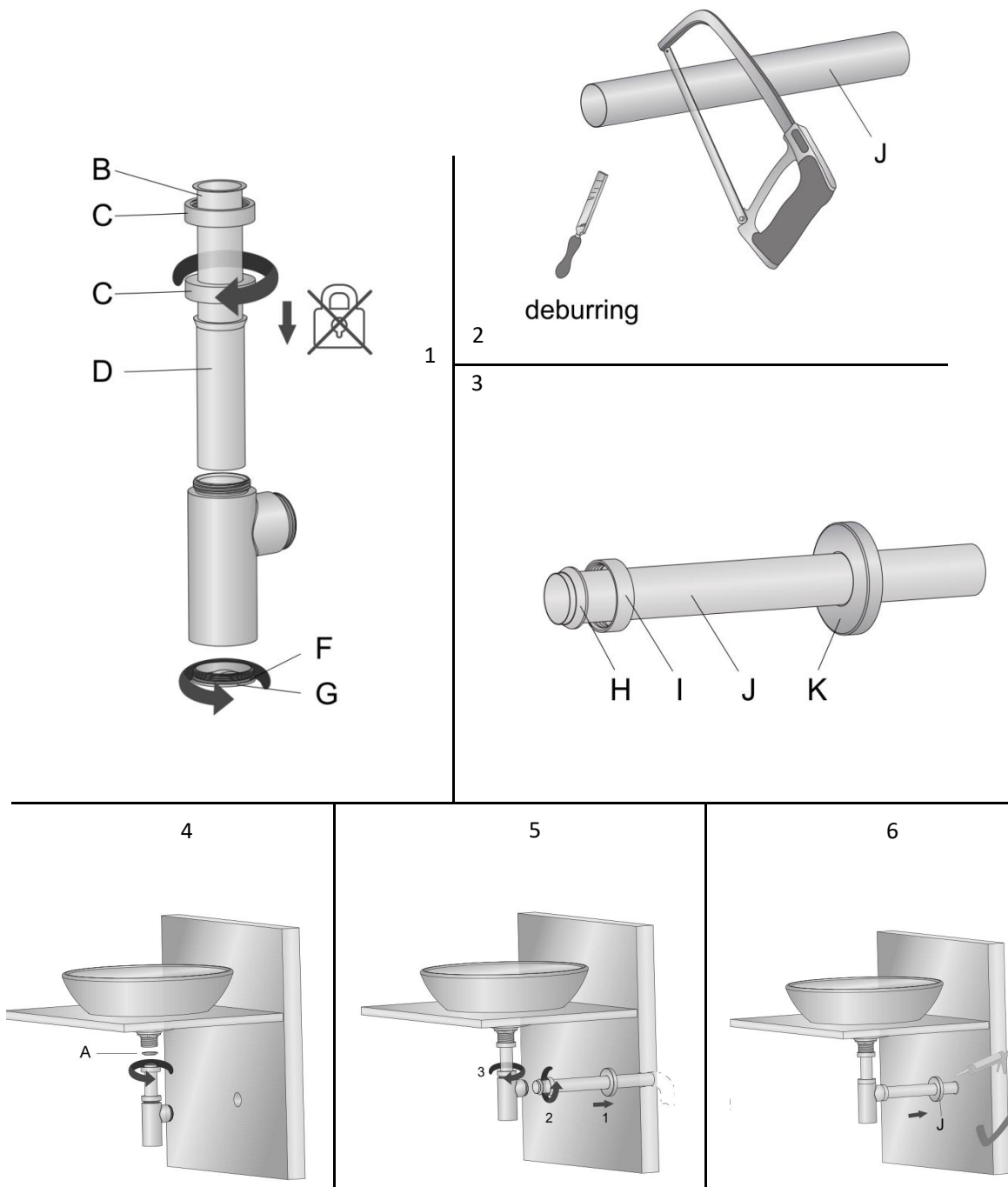

**5 year limited warranty. For more warranty information please check www.aifol.net
 For customer service concerns or support please email: support@aifeiling.com**