



Product Manual



Sink Drain

Model: BA-SD-12840

Sink Drain Without Overflow

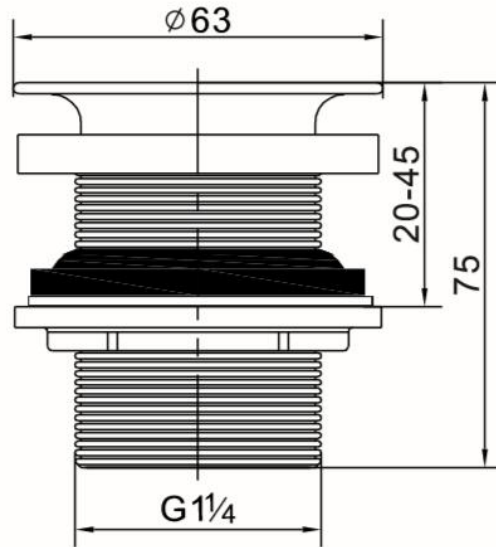

READ ALL INSTRUCTIONS BEFORE UNPACKING THE PRODUCT!

NOTICE: Observe all local plumbing and building codes.

NOTICE: This is a general installation guideline, actual installation may vary. Consult a professional if necessary.

NOTICE: Product drawings in this installation guide is for illustration purpose only. Actual product may vary by models

NOTICE: Read and understand this installation guide completely.

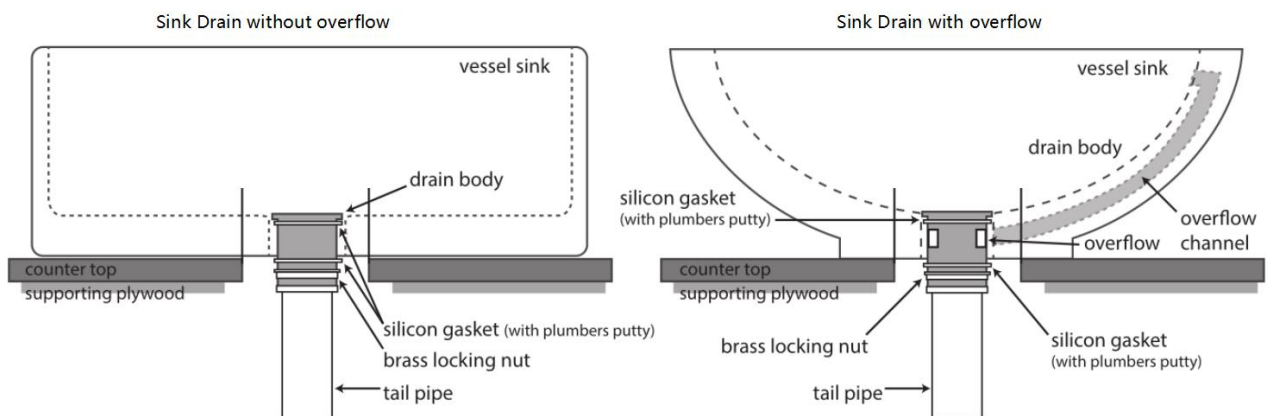

Attention:

If your sink has overflow hole, please choose the sink drain with overflow. If not, you can choose sink drain without overflow.

PREPARE FOR INSTALLATION:

1. Please check the image of the drain's detailed dimensions to make sure the stopper fits for your basin or sink.
2. To avoid leakage, clean up the top and bottom sides of the sink and remove old silicone, rubber, dried putty and calcified deposits
3. Use a plastic putty knife so you don't scratch the sink

INSTALLATION:

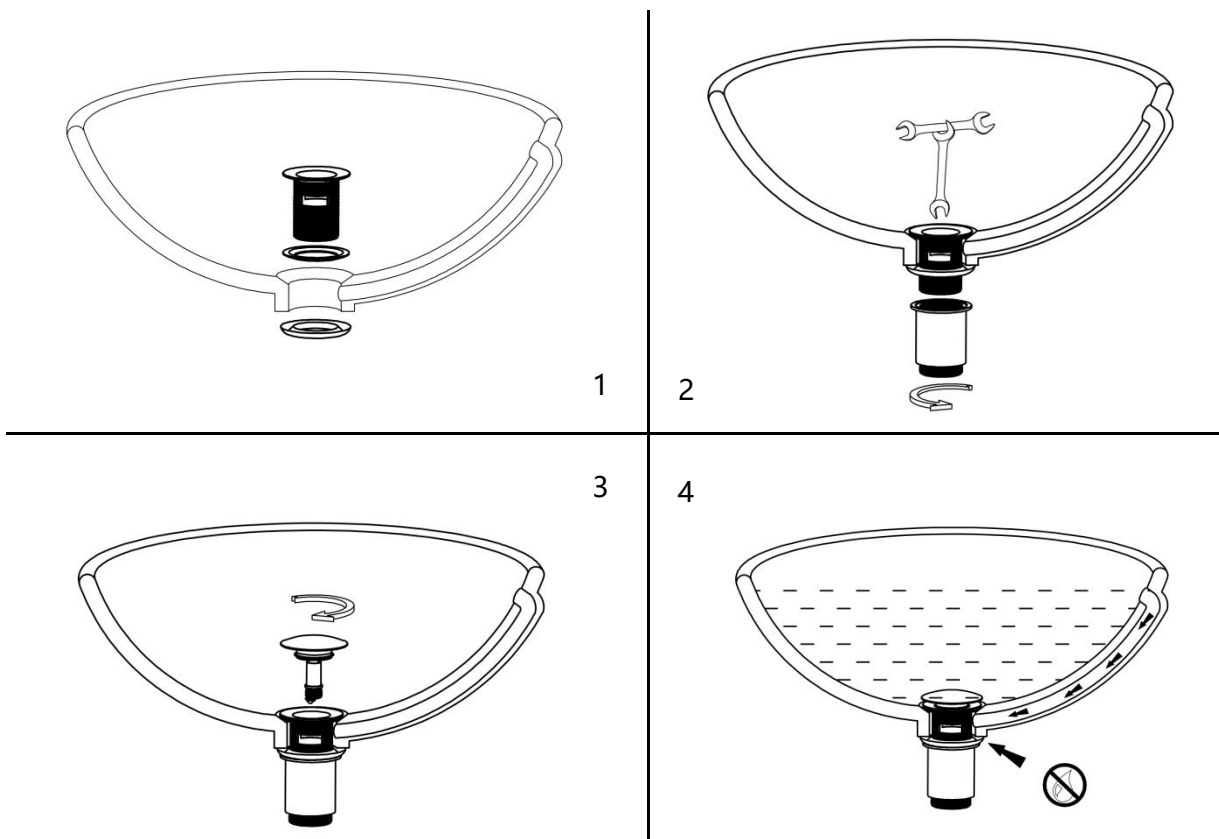

5 year limited warranty. For more warranty information please check www.aifol.net
 For customer service concerns or support please email: support@aifeiling.com