

TECHNICAL DATA SHEET

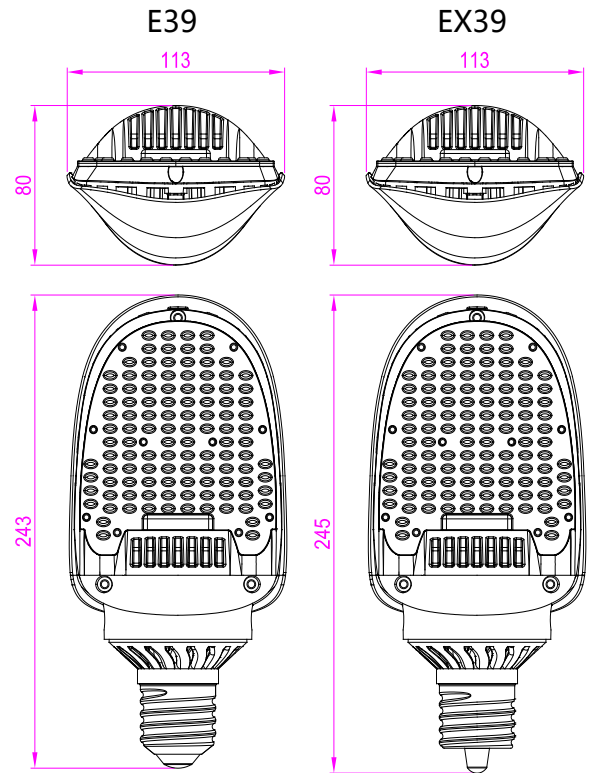

NAME: LED Retrofit Kit

P/N: CLH-27W1A1Y

Note: The Letter Y in P/N stands for Lamp base type, "-E" for E39 lamp base, "-EX" for EX39 lamp base.

Advantage

- UL、CUL、DLC certificate
- LUMILEDS chip, high CRI.
- 90*150 degree.
- Internal driver, input voltage AC100-277V.
- E39、EX39 lamp base.
- Lamp Base: 270 degree rotated.
- New style and high efficient wide-range input.
- Long lifespan and good heat dissipation.
- Direct replacement for Metal Halide, easy Installation.
- Fits many different fixtures to replace traditional lamps.

Application

Replacement Lamps for Outdoor Pole/Arm-mounted Area and Roadway Luminaires(Type B).

TECHNICAL DATA SHEET

| PRODUCT SPECIFICATIONS | | |
|---------------------------------|--|---------------|
| Product name | LED Retrofit Kit | |
| Part No | CLH-27W1A1-E | CLH-27W1A1-EX |
| Lamp Base | E39 | EX39 |
| Dimension | 243*113*80 MM | 245*113*80 MM |
| Technical Characteristic | | |
| Color temperature | 4000K、5000K、5700K | |
| CRI | > 70 | |
| Lumen-In Luminaires | 3000-3300 LM | |
| Lumen Efficacy-In Luminaires | 110-120 LM/W | |
| Input Power | 27W | |
| Viewing Angle | 90*150degree | |
| Input Voltage | AC100-277V 50/60Hz | |
| PF | >0.9 | |
| Equivalent | 60W CFL, 100W MHL/HPS/HID | |
| Waterproof Rating | IP51 | |
| MATERIALS | | |
| LED Brand | LUMILEDS | |
| LED Type | LUXEON 3030 2D (1.5W) | |
| LED QTY | 56 PCS | |
| Housing | Magnesium Alloy+AL+PC | |
| Housing color | Black+Silver | |
| OTHERS | | |
| Operating Temperature | -20°C TO 45°C | |
| Operating Humidity | 20%-70% RH | |
| Storage Temperature | -30°C TO 80°C | |
| Storage Humidity | 10%-75% RH | |
| Application | Replacement Lamps for Outdoor Pole/Arm-mounted Area and Roadway Luminaires | |
| Safety Certification | UL、CUL、DLC | |
| Warranty Time | 5 Years | |

TECHNICAL DATA SHEET

Remark: The testing data comes from the product in luminaires.

| DATA OF LAMP | | PHOTOMETRIC DATA | | | | Eff: 117.07 lm/W |
|-------------------|---------|-----------------------|--------|---------------------|-----------|------------------|
| MODEL | | I _{max} (cd) | 1066 | S/MH (C0/180) | 1.42 | |
| NOMINAL POWER (W) | 27 | LOR (%) | 100.0 | S/MH (C90/270) | 1.14 | |
| RATED VOLTAGE (V) | 120 | TOTAL FLUX (lm) | 3032.0 | η UP, DN (C0-180) | 0.0, 63.1 | |
| NOMINAL FLUX (lm) | 3032.05 | CIE CLASS | DIRECT | η UP, DN (C180-360) | 0.0, 36.9 | |
| LAMPS INSIDE | 1 | η up (%) | 0.0 | CIBSE SHR NOM | 1.50 | |
| TEST VOLTAGE (V) | 120.0 | η down (%) | 100.0 | CIBSE SHR MAX | 1.55 | |

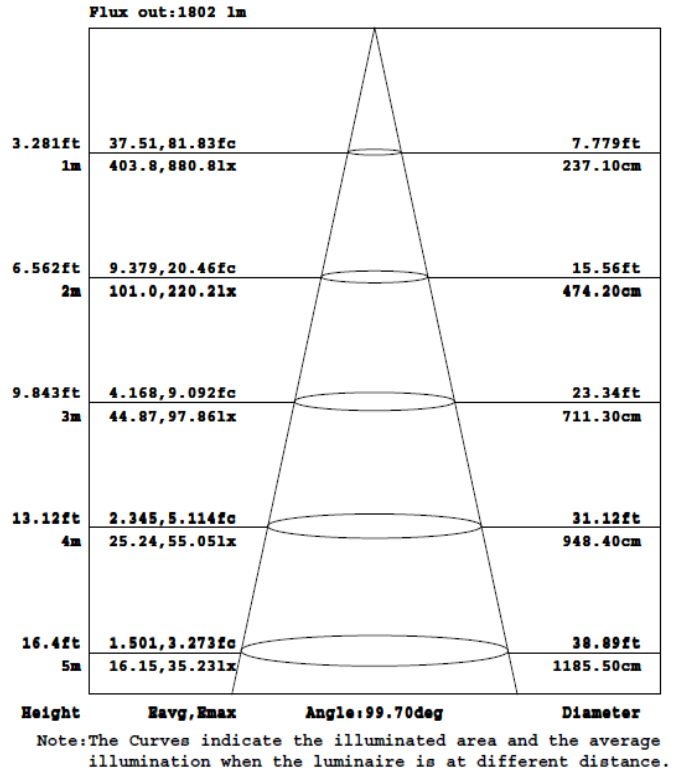
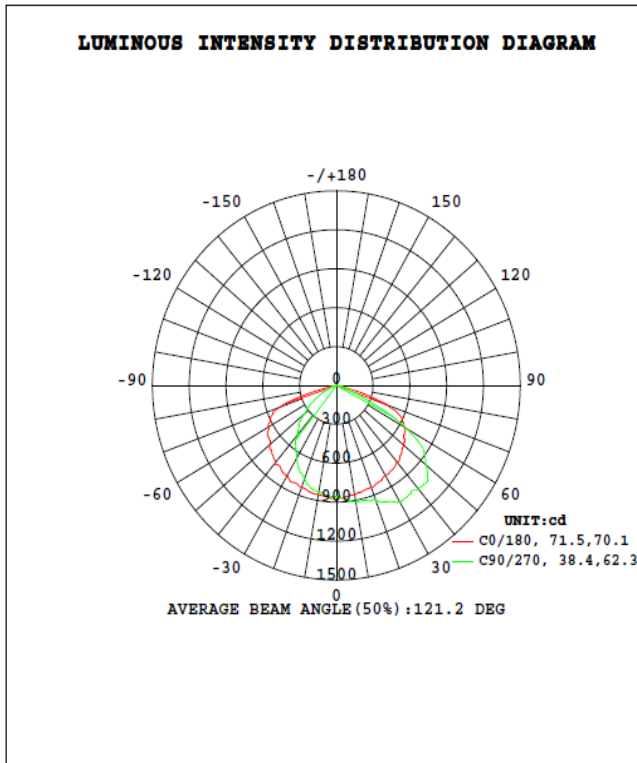

TECHNICAL DATA SHEET

Package

LED Retrofit Kit

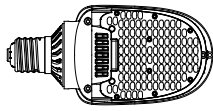

Into PE bag

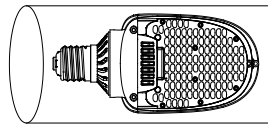

Into EPE

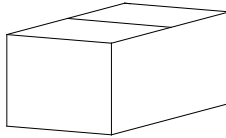
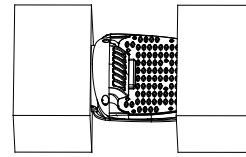

Joint sealing

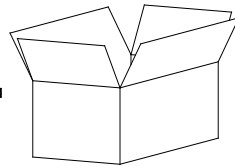

Into outer box

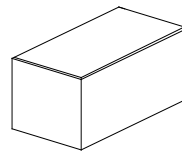

Cover inner box

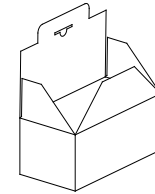

Into inner box

| | Size | Qty/ Carton | Net Weight/ Carton | Gross Weight/ Carton |
|-----------|----------------|----------------|-----------------------|-------------------------|
| Inner box | 290*135*105 MM | 1 PC | 0.72 KG | 0.88 KG |
| Outer box | 560*310*235 MM | 8 PCS | 5.7 KG | 7.8 KG |

Notice For User

- Please turn off power before install or change assembly parts.
- The input voltage and lamps should be matched, after connecting the power line, please make sure the wiring section is insulated.
- Make sure to remove or bypass the ballast in the fixtures before install the lamps.
- Suitable for damp locations. Do not use with dimmers.
- Suitable for use in enclosed luminaires, min. lamp compartment dimensions: 340*200*200MM.
- No-professionals, must not install and disassemble the lamps.

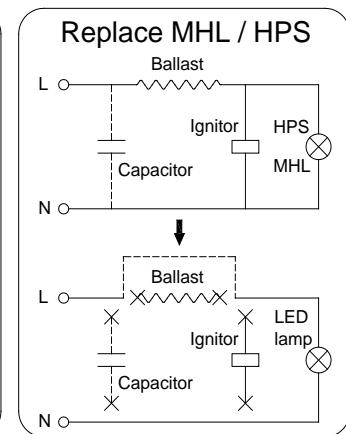
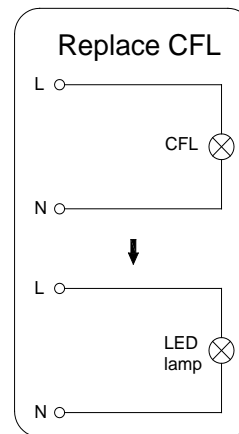

Trouble Shootings

| Troubles | Check points |
|-------------------------|--|
| Flickering of the lamps | Turn off the power and turn on again in 3 minutes. If same phenomena occur, then call agencies |
| Out of working | Please check the connection |