



NAME: LED Wall Pack Light

P/N : WP03-15WC1

Advantage:

- UL cUL DLC certificate
- IP65 Internal driver, Input voltage 100-277VAC
- No UV or IR in the beam
- Easy to install and operate
- Energy saving, long lifespan
- Instant start, NO humming
- Green and eco-friendly without mercury.

Application:

- ◆ entrance lighting, courtyard lighting
- ◆ Industrial lighting, Outdoor landscape lighting;
- ◆ Building, The hotel;
- ◆ Wall lighting area and so on.

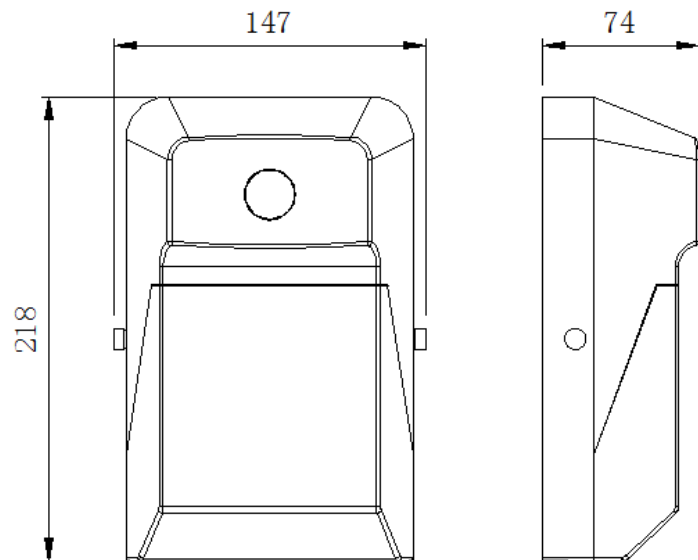

TECHNICAL DATA SHEET

Product Specifications

Product name	LED Wall Pack Light
Part No	WP03-15WC1
Dimension	218*147*74 mm

Technical Characteristic

Color temperature	3000K	3500K	4000K	4500K	5000K	5700K
CRI	>80					
Lumen	1575-1720LM					
Lumen Efficacy	105-115LM/W					
Input Power	15W					
Viewing Angle	110°					
Input Voltage	100-277VAC 50/60Hz					
Driver model	China Brand Driver					
PF	>0.9					
Waterproof Rating	IP65					

Materials

LED Type	2835 (0.2W)
LED QTY	120 PCS
Housing	Aluminum
Optional Accessory	Photocell (Option)
Housing color	Black

Others

Operating Temperature	-20°C TO 45°C
Operating Humidity	20%-90% RH
Storage Temperature	-30°C TO 80°C
Storage Humidity	10%-95%
Application	Indoor / Outdoor
Safety Certification	UL、cUL、DLC
Warranty Time	5 Years

TECHNICAL DATA SHEET

Light Distribution Testing Parameters

DATA OF LAMP		PHOTOMETRIC DATA Eff: 105.30 lm/W	
MODEL		I _{max} (cd)	660.461
NOMINAL POWER(W)	15	LOR(%)	100.0
RATED VOLTAGE(V)	277	TOTAL FLUX(lm)	1605.8
NOMINAL FLUX(lm)	1605.80	CIE CLASS	DIRECT
LAMPS INSIDE	1	D up(%)	9.5
TEST VOLTAGE(V)	277	down(%)	90.5

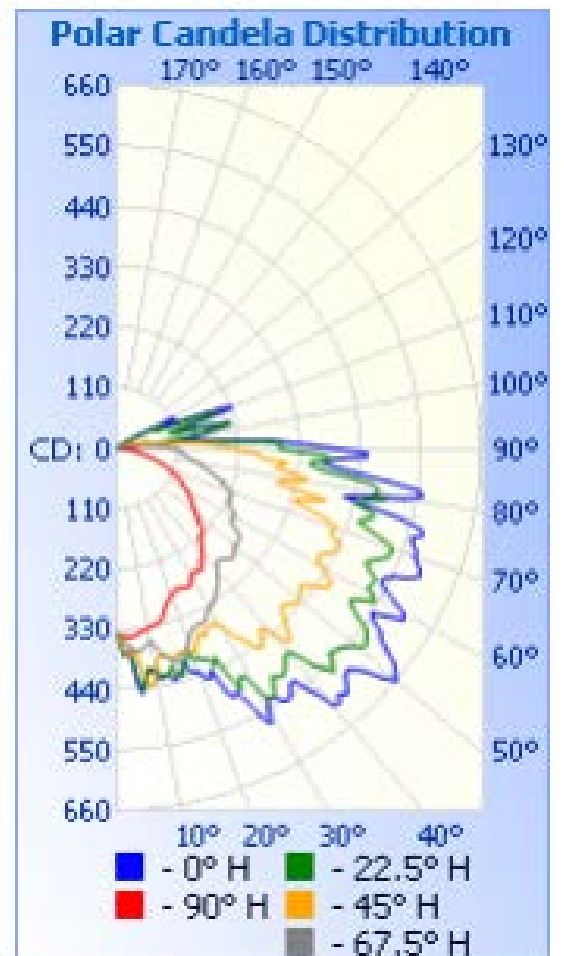
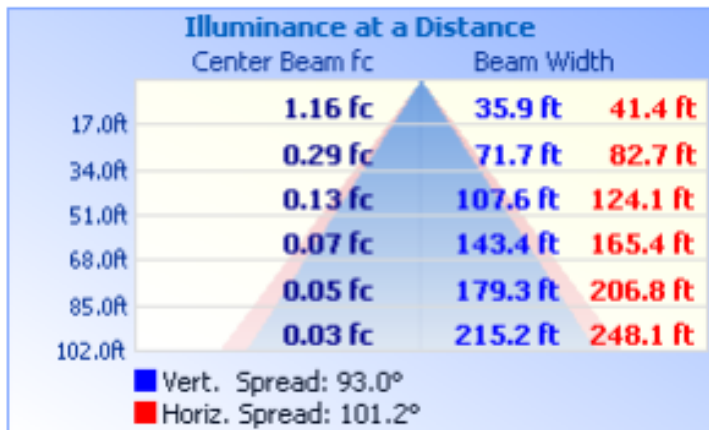

TECHNICAL DATA SHEET

Package

Lamps Net Weight: 0.82kg / pcs

	Size	Qty/Carton	Weight/Carton
Outer box	405 X 325 X 250 mm	10	10 kg
Inner box	151 X 78 X 228 mm	1	0.92 Kg

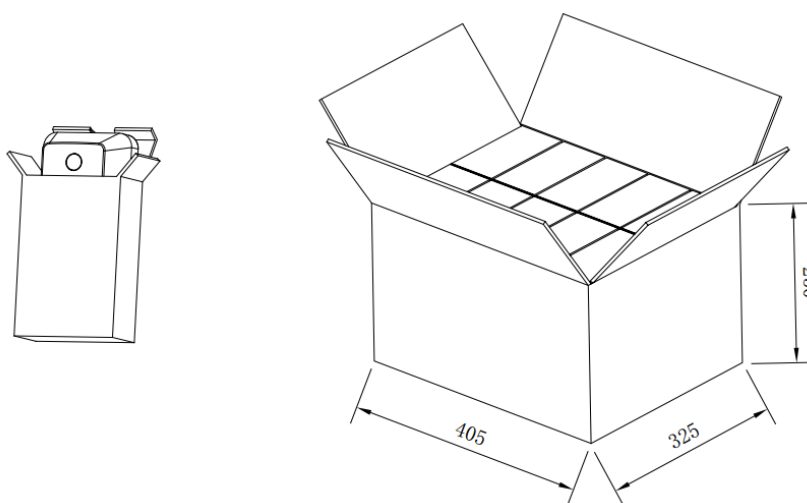

Notice For User

- ◆ Please turn off power before install or change assembly parts.
- ◆ The input voltage and lamps should be matched, after connecting the power line, Please make sure the wiring section is insulated.
- ◆ No-professionals, must not install and disassemble the lamps.

Trouble Shootings

Troubles	Check points
Flickering of the light	Turn off the power and turn on again in 3 minutes. If same phenomena occur, then call agencies
Out of working	Please check the connection