

CALIFORNIA CLOSETS®

SHOE SHELF 20" DEEP

Installation Manual

REPISA PARA ZAPATOS 20"

Manual de Instalación

ÉTAGÈRE À CHAUSSURES 20"

Manuel d'installation

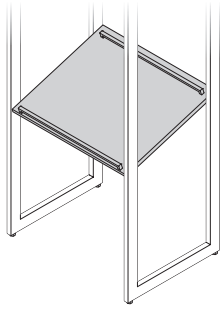

Included Parts | Piezas incluidas | Pièces contenues dans l'emballage

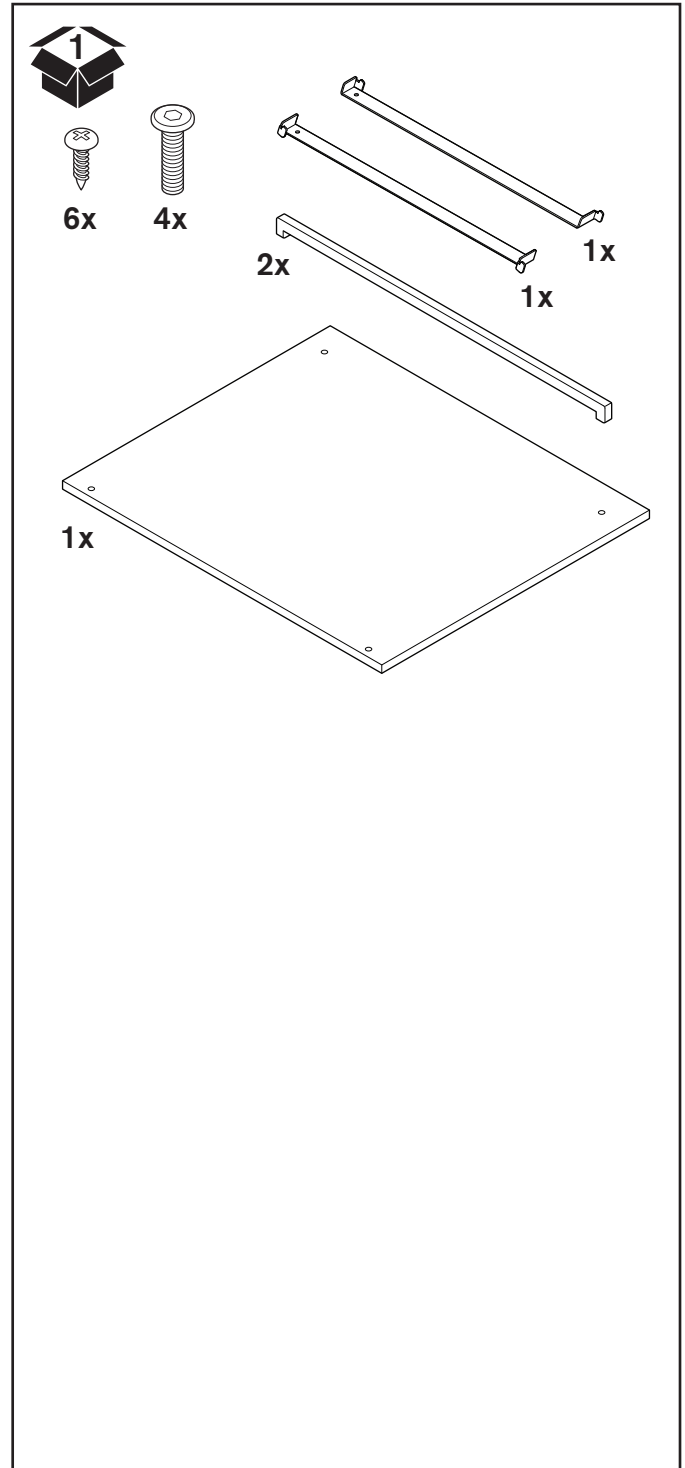

(EN) • THIS IS NOT A FREE-STANDING UNIT. FOR SAFETY, ALWAYS ANCHOR TO THE WALL.

- Do not attempt to assemble without **FIRST** securing Upright to the wall.
- **NEVER** allow children to stand, climb, or hang on drawers, doors, or shelves.

(ES) • ESTA UNIDAD NO ES INDEPENDIENTE. POR SEGURIDAD, SIEMPRE FÍJELA A LA PARED.

- No intente armar la unidad sin **PRIMERO** asegurar el montante a la pared.
- **NUNCA** permita a los niños pararse, subirse o colgarse de los cajones, puertas o estantes.

(FR) • CE MEUBLE N'EST PAS AUTOPORTANT. POUR VOTRE SÉCURITÉ, ANCREZ-LE TOUJOURS AU MUR.

- Ne tentez pas de procéder à l'assemblage sans avoir **D'ABORD** fixé le montant vertical au mur.
- Ne laissez **JAMAIS** les enfants monter, grimper ou se suspendre aux tiroirs, aux portes ou aux étagères.

Tools Required
Herramientas requeridas
Outils nécessaires

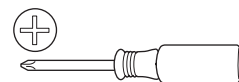

To watch videos detailing the installation process, please scan the QR code with your mobile device, or visit: shop.californiaclosets.com/pages/installation-everyday

Para ver videos que detallan el proceso de instalación, por favor escanee el código QR con su dispositivo móvil, o visite: shop.californiaclosets.com/pages/installation-everyday

Pour regarder une vidéo détaillant l'installation, scannez le code QR avec votre appareil mobile ou allez sur le site: shop.californiaclosets.com/pages/installation-everyday

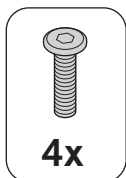
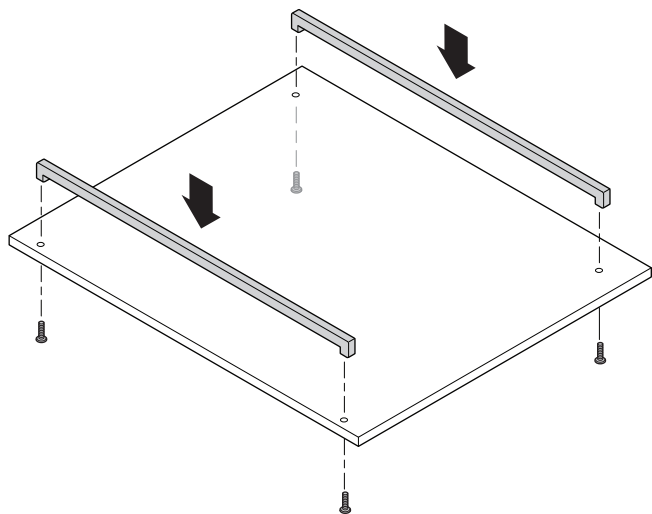
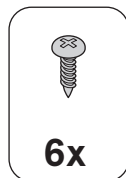
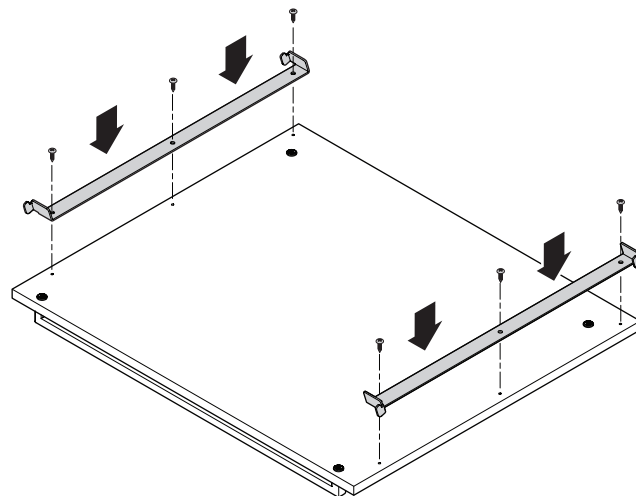
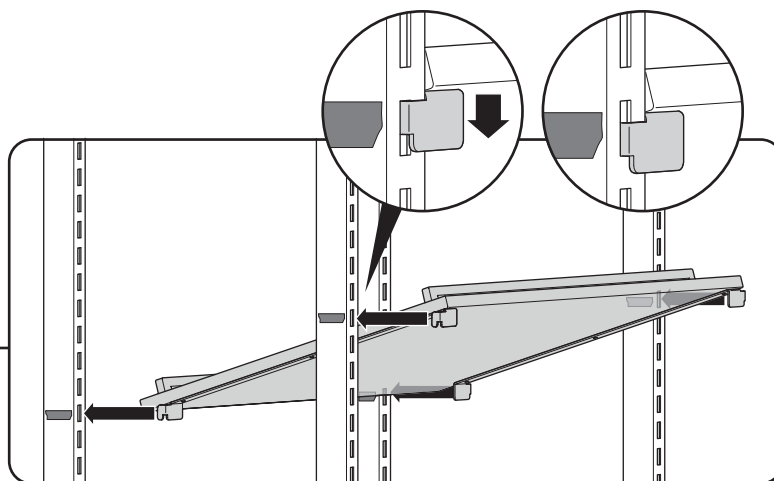
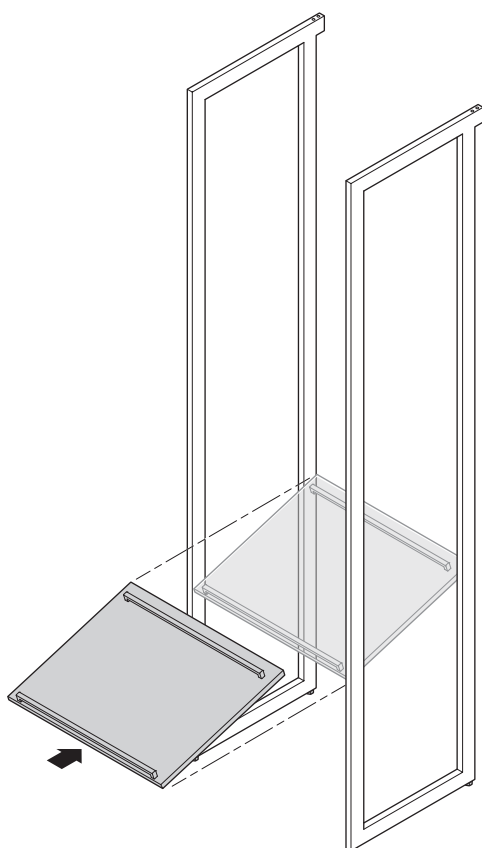
1**2****3****Tip:**

(EN) Mark your slot locations with blue painters' tape. This will make alignment of the brackets into the upright easier.

Sugerencia:

(ES) Marque las ubicaciones de las ranuras con cinta azul de pintor. Esto facilitará la alineación de los soportes en el montante.

Un conseil:

(FR) posez des repères au ruban adhésif de masquage bleu pour marquer l'emplacement de vos encoches. Cela facilitera l'alignement des supports dans les montants.

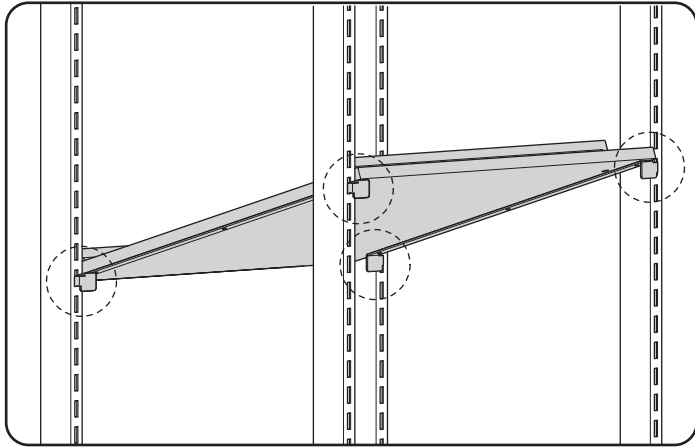

Note: Bracket is inserted into four slots.
Nota: El soporte se inserta en cuatro ranuras.
À noter : le support est inséré dans quatre encoches.

