



EWC-30LI

User Manual



Contents

| | |
|-------------------------------------|----|
| Important Safety Instructions | 1 |
| 1. Overview | 2 |
| 2. Exterior | 3 |
| 2.1 Designations of models | 3 |
| 2.2 Accessories (Included)..... | 4 |
| 2.3 Accessories (Optional)..... | 4 |
| 3. Installation and wiring..... | 5 |
| 3.1 Install the controller | 5 |
| 3.2 Wiring | 6 |
| 4. LCD display | 8 |
| 5. Protection | 10 |
| 6. Troubleshooting..... | 11 |
| 7. Technical Specifications | 12 |
| 8. Disclaimer | 14 |
| 9. Dimensions | 15 |

Thank you for selecting the EWC30-LI series solar charge controller. Please read this manual carefully before using the product and pay attention to the safety information. Please reserve this manual for future review.

Important Safety Instructions

This manual contains all instructions of safety, installation, and operation of GoMate series controller ("the controller" is referred to this manual).

- Read all the instructions and warnings carefully before installation.
- No user serviceable component inside the controller. DO NOT disassemble or attempt to repair the controller.
- Avoid direct sunlight, high temperatures and DO NOT install the controller at locations where water can get in.
- Install the controller at well-ventilated places, the controller's heat sink will be very hot during the system operation.
- Appropriate external fuses or breakers are suggested.
- Please cut off all connections of the PV array, fuses or breakers which close to the battery before the controller installation and adjustment.
- Power connections must remain tight to avoid excessive overheating from the loose connection.

1. Overview

The EWC-30LI is a negative-ground, flush mount solar charge controller, designed for an aesthetically clean and integrated look on RV and Vessel, also included surface mount cover to suit personal preference. The GoMate adopts highly efficient PWM charging mode, also comes equipped with special LCD display to show the real-time operating status of the system. This charge controller is fully controlled automatically, which provide simple usage pattern to users.

Features:

- Flush mounted and embedded installation design
- High quality and low failure rate components (ST/IR) to ensure the product lifetime
- 3-Stage intelligent PWM charging: Bulk, Boost/Equalize and Float
- Battery type: Sealed, Gel, Flooded, and User
- Real-time energy statistics feature
- Battery temperature compensation feature
- Digital LCD monitor for informative display of operational parameters and fault messages
- Voltage drop and temperature compensation sampling interface design
- RS485 communication port with Modbus protocol, and short circuit protection for 5V/200mA power supply
- Multiple communication peripherals
- Rated charging current at working temperature without de-rating
- Extensive electronic protections
- Monitor and set the parameters via PC software or APP

2. Exterior

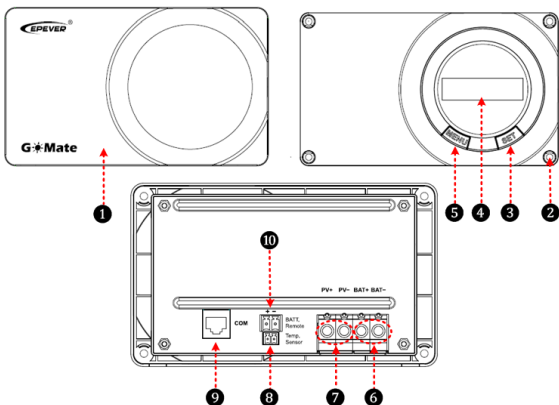

| | | | |
|---|---------------------------|---|---|
| ① | Controller case | ⑥ | Battery terminals |
| ② | Mounting hole sizeφ 4.5mm | ⑦ | PV terminals |
| ③ | SET button | ⑧ | Remote temperature sensor port ⁽¹⁾ |
| ④ | LCD | ⑨ | RS485 communication port |
| ⑤ | MENU button | ⑩ | Remote battery voltage sensor port ⁽²⁾ |

(1) The controller will charge the battery at 25°C as default and no temperature compensation when the temperature sensor is damaged.

(2) The port can detect accurate battery voltage (a 2P/1.5mm² wire (Red+, black-) with insulation protection is suggested). One end connects the 5.08-2P terminal to insert ⑩ port, the other end connects the battery, and make sure the “+” and “-” poles are connected correctly.

2.1 Designations of models

GM 30 24 N

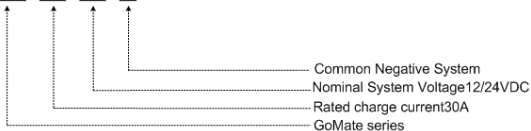

2.2 Accessories (Included)



Temperature Sensor
(Model: RT-MF58R47K3.81A)



5.08-2P Terminal

2.3 Accessories (Optional)

1) Remote Temperature Sensor(Model:RTS300R47K3.81A)



Acquisition of battery temperature for undertaking temperature compensation of control parameters, the standard length of the cable is 3m (length can be customized). The RTS300R47K3.81A connects to the port **8** on the controller.

NOTE: The temperature sensor short-circuited or damaged, the controller will be charged or discharged at the default temperature of 25 ℃.

2) USB to RS485 communication cable (Model:CC-USB-RS485-150U)



USB to RS485 converter is used to monitor each controller using Solar Station PC software. The length of cable is 1.5m. The CC-USB-RS485-150U connects to the RS485 Port on the controller.

3) RS485 TO WIFI Converter (Model:eBox-WIFI-01)



After the controller is connected with the eBox-WIFI-01 through the standard Ethernet cable (parallel cable), the operating status and related parameters of the controller can be monitored by the mobile APP software through WIFI signals.

4) RS485 TO BLE Converter(Model:eBox-BLE-01)



After the controller is connected with the eBox-BLE-01 through the standard Ethernet cable (parallel cable), the operating status and related parameters of the controller can be monitored by the mobile APP software through Bluetooth signals.

5) Logger(Model:eLOG01)



After the controller is connected with the eLOG-01 through the RS485 communication cable, it can record the operating data of the controller or monitor the real-time operating status of the controller via PC software.

6) Remote Meter(Model:MT50)



MT50 displays various operating data and fault info to the system. The information can be displayed on a backlit LCD screen, the buttons are easy-to-operate, and the numeric display is readable.

3. Installation and wiring

3.1 Install the controller

1) Determine the Installation Location and Heat-dissipation Space

Determination of installation location: The controller shall be installed in a place with sufficient air flow through the radiators of the controller and a minimum clearance of 150 mm from the upper and lower edges to ensure natural thermal convection.

2) Determine the size of Installation Location (158*96mm)

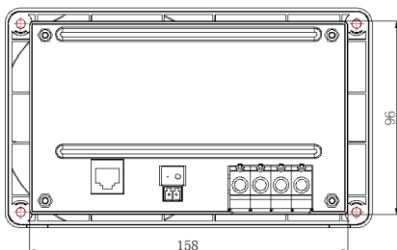

3) Cut out the section (158*96mm)

4) Mark holes and drill holes $\varnothing 3.5\text{mm} \times 4$

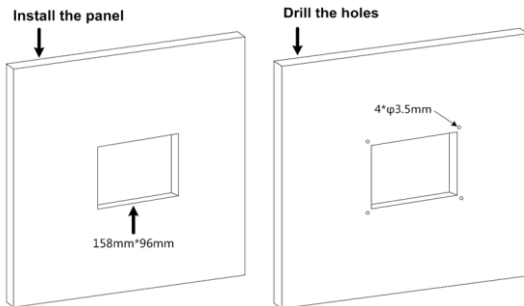

5) Secure the controller

Install the controller

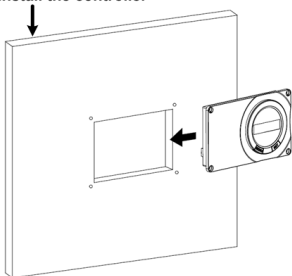

Turn the screw

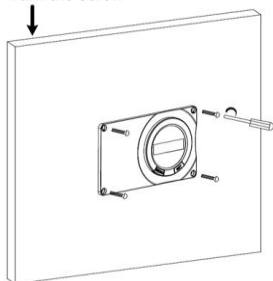

6) Install the control case

Install the controller case

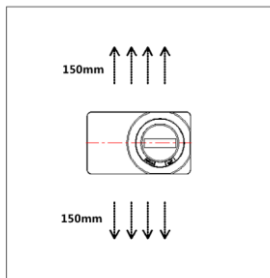
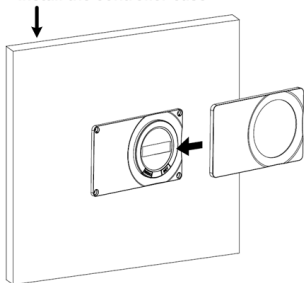

3.2 Wiring

Step1: connect the battery



CAUTION: A fuse which current is 1.25 to 2 times the rated current of the controller must be installed on the battery side with a distance from the battery not greater than 150 mm.

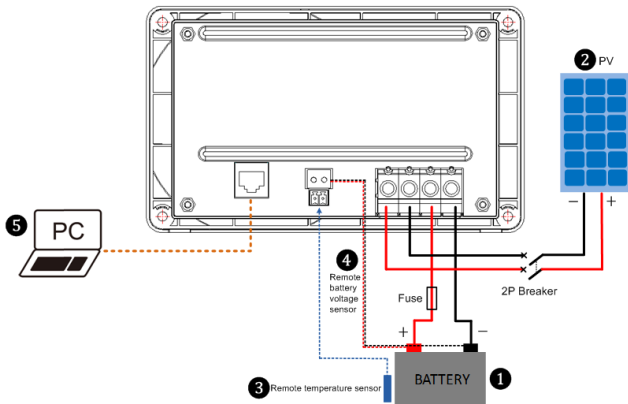

Step2: Connect the PV ②



CAUTION: While wiring the controller do not turn on the breaker or fuse and make sure that the leads of "+" and "-" poles are connected correctly.



CAUTION: If the controller is used in the ungoverned or frequent lightning area, must install a reasonable arrester in the PV array input side.

Step3: Connect the Remote temperature sensor cable ③



NOTE: The controller will charge or discharge the battery at 25°C as default and no temperature compensation when the temperature sensor is damaged.

Step4: Connect the Remote battery voltage sensor ④



CAUTION: Make sure that the battery voltage sensor cable of "+" and "-" poles are connected correctly when wiring.

Step5: Connect the PC via the RS485 communication port ⑤

Refer to the chapter 4 "Remote set battery type".

4. LCD display

1) Automatic cycle interface

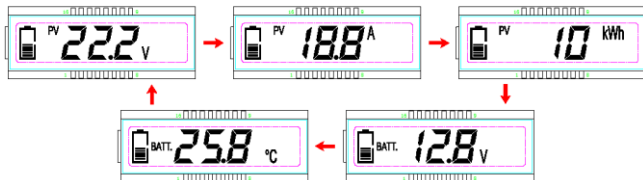

Display: PV voltage, PV current, PV power, Battery voltage and Battery temperature

2) Clear the generated energy

Operation:

Step 1: Press the “SET” button and hold 5s under the PV power interface and the value is flashing.

Step 2: Press the “SET” button to clear the generated energy

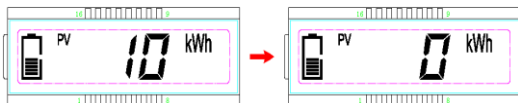

3) Switch the battery temperature unit

Press the “SET” button and hold 5s under the battery temperature interface.

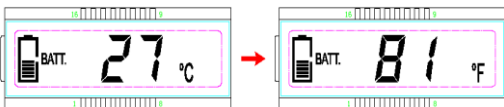

4) Battery type

+ Battery type

Sealed Gel Flooded User⁰³

+ Set battery type by LCD⁰³

Operation:

Step1: Press the “SET” button and hold 5s under the battery voltage interface.

Step2: Press the “MENU” button when the battery type interface is flashing.

Step3: Press the “SET” button to confirm the battery type.



+ Set battery type by PC⁽¹⁾

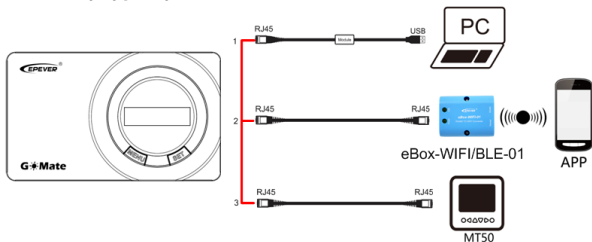



Download software

www.epever.com——Solar Station Monitor

www.epever.com——ChargeController(Sealed)

(1)Only Sealed, Gel and Flooded via the LCD, The battery type of User can be set via the PC software, APP software and MT50.



5) System status icon

| Icon | Phenomenon | Instruction |
|---|--------------------------|---------------------------------------|
|  | Solid | The system is normal but not charging |
| | Energy bars are Flashing | Charging |
|  | Solid | Full |
| | Flashing | Battery Overvoltage |
|  | Flashing | Battery Over Discharge |

5. Protection

| Protection | Instruction |
|-----------------------------|---|
| PV Overcurrent | When the charging current of the PV array exceeds the controller's rated current, it will be charged at the rated current. |
| PV Overvoltage | When the voltage of PV will exceed 50V, the controller will stop charging and restart to charge when the PV voltage is below 45V |
| PV short circuit | When the PV voltage is below 50V and short circuit, the controller will stop charging; the controller restart to charge when the fault is cleared, it doesn't damage the controller. |
| PV Reverse Polarity | When the polarity of the PV array is reversed, the controller may not be damaged and can continue to operate normally after the polarity is corrected. |
| Night Reverse Charging | Prevents the battery from discharging to the PV module at night. |
| Battery Reverse Polarity | Fully protected against battery reverse polarity; no damage will occur to the battery. Correct the wiring error to resume normal operation. |
| Battery Overvoltage | When the battery voltage reaches the overvoltage disconnect voltage, it will automatically stop battery charging to prevent battery damage caused by over-charging. |
| Battery Overheating | The controller can detect the battery temperature through an external temperature sensor. The controller stops working when its temperature exceeds 65 °C and restart to work when its temperature is below 55 °C. |
| Controller Overheating | The controller is able to detect the temperature inside the battery. The controller stops working when its temperature exceeds 85 °C and restart to work when its temperature is below 75 °C. |
| TVS High Voltage Transients | The internal circuitry of the controller is designed with Transient Voltage Suppressors (TVS) which can only protect against high-voltage surge pulses with less energy. If the controller is to be used in an area with frequent lightning strikes, it is recommended to install an external surge arrester. |

6. Troubleshooting

| Faults | Possible reasons | Troubleshooting |
|--|--------------------------------------|---|
| The PV of LCD display 0 when the sunshine falls on PV modules properly | PV array disconnection | Confirm that PV wire connections are correct and tight |
| LCD is no display | Min.8V will start up the controller. | Measure battery voltage with multi-meter. Min.8V can start up the controller. |
|  Flashing | Battery Overvoltage | Disconnect the solar array and measure the battery voltage whether is too high; |
|  Flashing | Battery Over Discharge | Charge the battery |

7. Technical Specifications

Electrical Parameters

| Item | GM3024N |
|------------------------------------|-----------------------------------|
| Nominal System Voltage | 12/24VDC or Auto |
| Battery Input Voltage Range | 8V~32V |
| Rated Charge Current | 30A |
| Max. PV Short Circuit Current | 30A |
| Max. PV Open Circuit Voltage | 50V |
| Battery Type | Sealed(default)/Gel/Flooded/User★ |
| Self-consumption | ≤4.2mA/12V;≤2.6mA/24V |
| Temperature Compensate Coefficient | -3mV/°C/2V(Default) |
| Charge Circuit Voltage Drop | 0.21V |

★The battery type of User can be set via the PC software, APP software and MT50. Refer to table 1(Page 13).

Environmental Parameters

| | |
|---------------------------------|------------------------------------|
| Storage Temperature Range | -30°C~+80°C |
| Working Environment Temperature | -20°C~+55°C(100% input and output) |
| Relative Humidity | ≤95%, N.C. |
| Enclosure | IP30 |
| Grounding | Common negative |
| Altitude | 5000m |
| Pollution Degree | PD2 |

Mechanical Parameters

| | |
|--------------------|-------------------------|
| Dimension (LxWxH) | 178.5x105.5x48.3mm |
| Mounting dimension | 166.5x93.5mm |
| Mounting hole size | Φ5mm |
| Terminal | 16mm ² /6AWG |
| Recommended cable | 10mm ² /8AWG |
| Net Weight | 0.31kg |

Lead-acid Battery Voltage Parameters
Table1
Parameters are in the 12V system at 25°C, x2 in 24V.

| Item | Sealed | Gel | Flooded | User |
|---|---------|---------|---------|------------|
| Over Voltage Disconnect Voltage | 16.0V | 16.0V | 16.0V | 9~17V |
| Charging Limit Voltage | 15.0V | 15.0V | 15.0V | 9~17V |
| Over Voltage Reconnect Voltage | 15.0V | 15.0V | 15.0V | 9~17V |
| Equalize Charging Voltage | 14.6V | — | 14.8V | 9~17V |
| Boost Charging Voltage | 14.4V | 14.2V | 14.6V | 9~17V |
| Float Charging Voltage | 13.8V | 13.8V | 13.8V | 9~17V |
| Boost Reconnect Charging Voltage | 13.2V | 13.2V | 13.2V | 9~17V |
| Low Voltage Reconnect Voltage | 12.6V | 12.6V | 12.6V | 9~17V |
| Under Voltage Warning Reconnect Voltage | 12.2V | 12.2V | 12.2V | 9~17V |
| Under Volt. Warning Volt. | 12.0V | 12.0V | 12.0V | 9~17V |
| Low Volt. Disconnect Volt. | 11.1V | 11.1V | 11.1V | 9~17V |
| Discharging Limit Voltage | 10.6V | 10.6V | 10.6V | 9~17V |
| Equalize Duration | 120min. | — | 120min. | 0~180min. |
| Boost Duration | 120min. | 120min. | 120min. | 10~180min. |

(1)When the battery type is sealed, gel, flooded, the adjusting range of equalizing duration is 0 to180min and boost duration is 10 to180min.

(2) The battery type of User should follow the rules as below when modifying the value of parameters in user battery type (factory default value is the same as sealed type):

a. Over Voltage Disconnect Voltage > Charging Limit Voltage ≥ Equalize Charging Voltage ≥ Boost Charging Voltage ≥ Float Charging Voltage > Boost Reconnect Charging Voltage.

b. Over Voltage Disconnect Voltage > Over Voltage Reconnect Voltage

c. Low Voltage Reconnect Voltage > Low Voltage Disconnect Voltage ≥ Discharging Limit Voltage.

d. Under Voltage Warning Reconnect Voltage > Under Voltage Warning Voltage ≥ Discharging Limit Voltage.

e. Boost Reconnect Charging voltage > Low Voltage Disconnect Voltage.

8. Disclaimer

The following situations are not covered by the company policy of warranty:

- Damage from improper use or use in an unsuitable environment.
- PV or load current, voltage or power exceeding the rated value of the controller.
- The controller working temperature exceeds the range of working temperature.
- User disassembles and attempts to repair the controller without permission.
- The controller is damaged due to natural causes such as lightning.
- The controller is damaged during transportation and shipment.

9. Dimensions

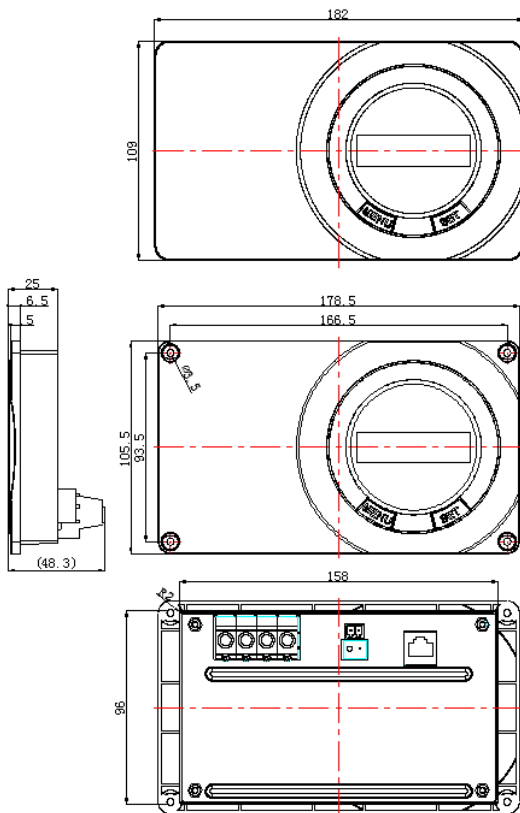

Any changes without prior notice! V1.1



TCED
INTL INC.

Distribué par/Distributed by:

TCED INTL Inc.

700, chemin du Grand Bernier Nord
Saint-Jean-sur-Richelieu (Québec) J2W
2H1