

SHERLE WAGNER INTERNATIONAL

ONYX LAUREL LEVER FAUCET SET 1030BSN818-XXXX-XX



1030BSN818-HNOX-GP

PRODUCT FEATURES

- o Available in all Sherle Wagner International finishes
- o Solid brass/bronze construction
- o 1.0 gpm (3.8 L/min) flow rate
- o Includes (2) 1/2" washerless 1/4 turn ceramic valves
- o Includes (2) flexible hoses 1/2" FIP x 1/2" FIP x 12" length
- o Includes gaskets and tee fitting
- o Includes lift rod and self sealing pop-up assembly
- o Recommended 12" spread. Can be installed 8"-16"
- o Refer to stone chart for standard stone insert, contact sales associate for custom stone options

AVAILABLE METAL FINISHES

PN Polished Nickel	PB Polished Brass	ES English Silver	AG Antique Gold
CP Polished Chrome	FP Flemish Patina	BS Butler Silver	SP Satin Platinum
BN Brushed Nickel	EP English Patina	RG Rose Gold	HP High Polished Platinum
BC Brushed Chrome	VA Verdi Antique	AP Antique Pewter	BP Burnished Platinum
SB Satin Brass	GP Gold Plate	PE Black Pearl	
OB Oil Rubbed Brass	AL Almond Gold	BG Burnished Gold	

AVAILABLE ONYX INSERTS

BROX Brown Onyx	CROX Cream Onyx	WHOX White Onyx	HNOX Honey Onyx
PKOX Pink Onyx	BKOX Black Onyx	GROX Green Onyx	

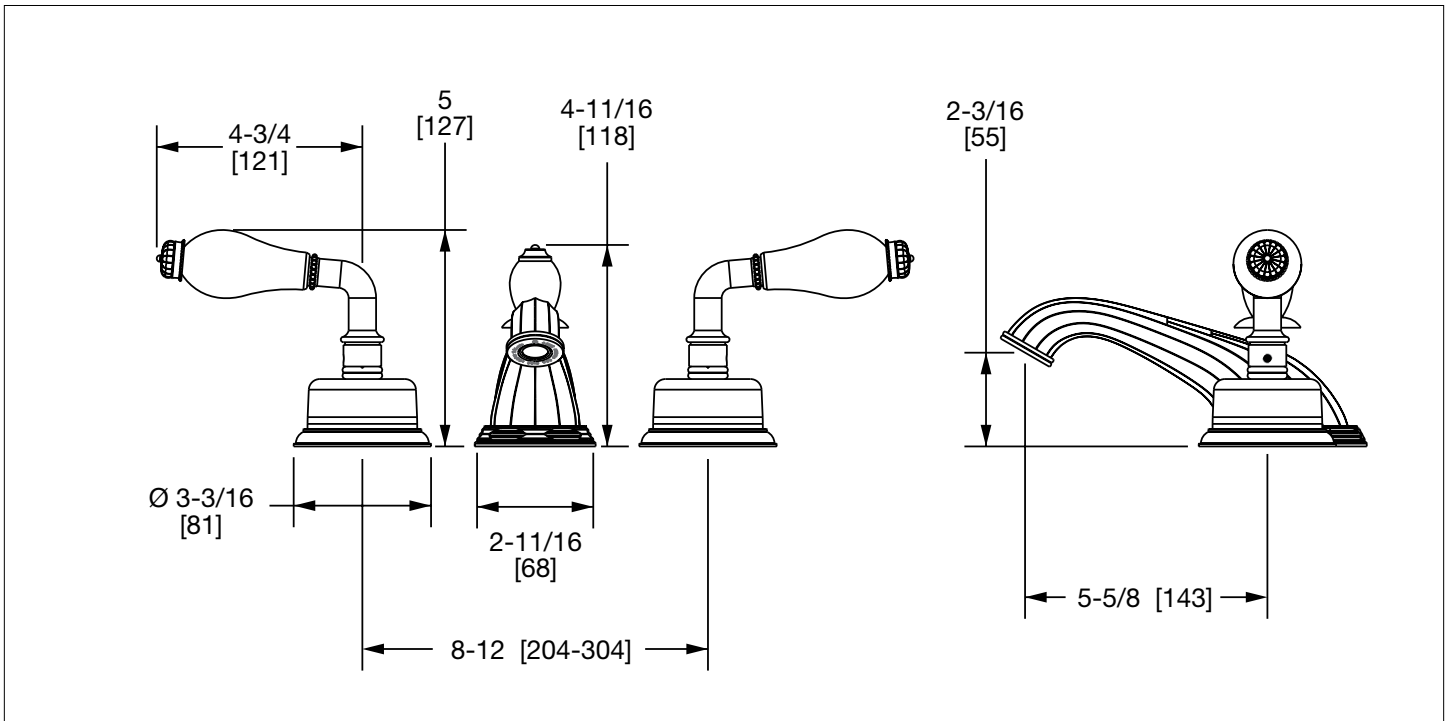

The measurements shown are for reference only. Products and specifications shown are subject to change without notice.

Rev B