

SHERLE WAGNER INTERNATIONAL

CUT CRYSTAL EMPIRE LEVER FAUCET SET 0914BSN819-CTCR-XX



PRODUCT FEATURES

- o Available in all Sherle Wagner International finishes
- o Solid brass/bronze construction
- o 1.0 gpm (3.8 L/min) flow rate
- o Includes (2) 1/2" washerless 1/4 turn ceramic valves
- o Includes (2) flexible hoses 1/2" FIP x 1/2" FIP x 12" length
- o Includes gaskets and tee fitting
- o Includes lift rod and self sealing pop-up assembly
- o Recommended 12" spread. Can be installed 8"-16"

AVAILABLE METAL FINISHES

PN Polished Nickel
 CP Polished Chrome
 BN Brushed Nickel
 BC Brushed Chrome
 SB Satin Brass
 OB Oil Rubbed Brass

PB Polished Brass
 FP Flemish Patina
 EP English Patina
 VA Verdi Antique
 GP Gold Plate
 AL Almond Gold

ES English Silver
 BS Butler Silver
 RG Rose Gold
 AP Antique Pewter
 PE Black Pearl
 BG Burnished Gold

AG Antique Gold
 SP Satin Platinum
 HP High Polished Platinum
 BP Burnished Platinum

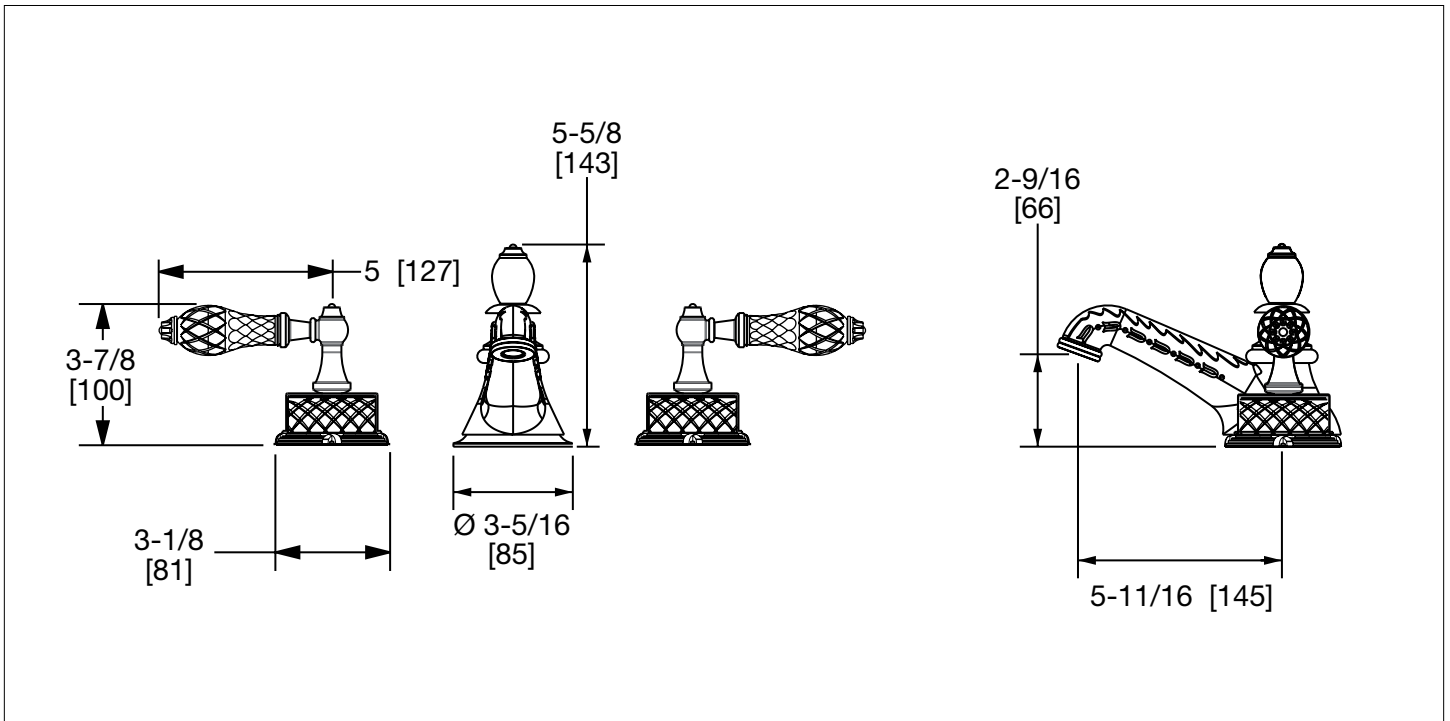

The measurements shown are for reference only. Products and specifications shown are subject to change without notice.

Rev A