

SHERLE WAGNER INTERNATIONAL

RENAISSANCE STANDARD 3/4" PAUMELLE "H" HINGE 0096-6-ZZ-XX

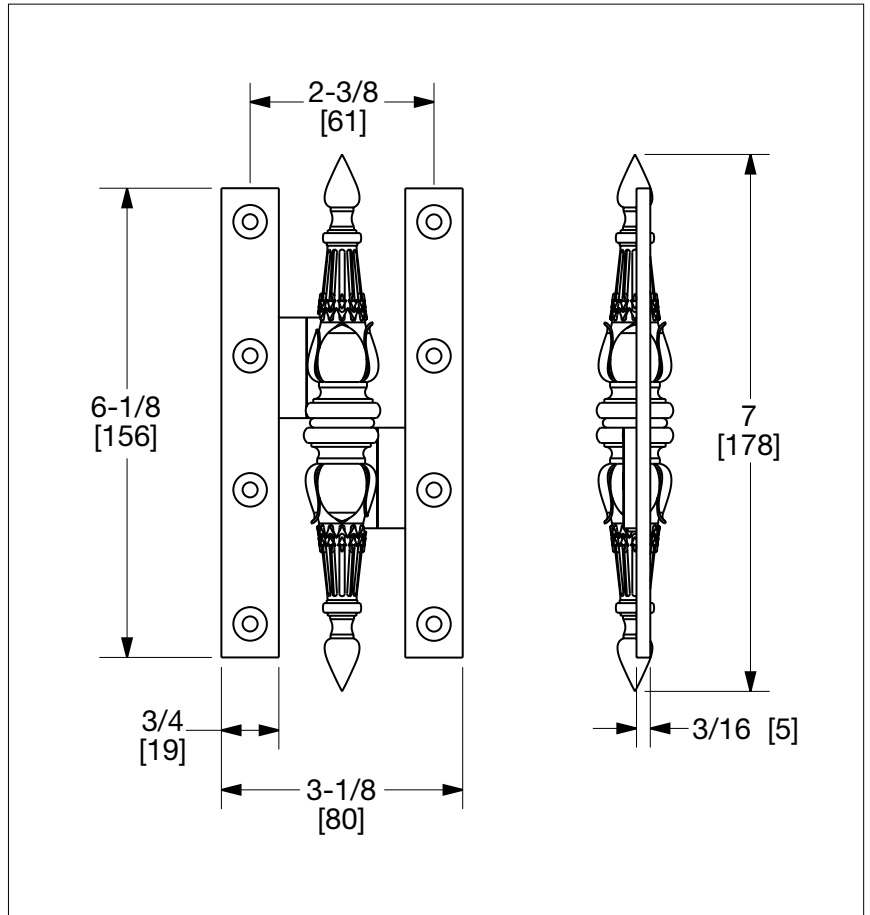

PRODUCT FEATURES

- o Available in all Sherle Wagner International finishes
- o Solid brass/bronze construction
- o Includes mounting hardware
- o Specify RH right hand, or LH left hand when ordering

AVAILABLE METAL FINISHES

PN Polished Nickel
CP Polished Chrome
BN Brushed Nickel
BC Brushed Chrome
SB Satin Brass
OB Oil Rubbed Brass

PB Polished Brass
FP Flemish Patina
EP English Patina
VA Verdi Antique
GP Gold Plate
AL Almond Gold

ES English Silver
BS Butler Silver
RG Rose Gold
AP Antique Pewter
PE Black Pearl
BG Burnished Gold

AG Antique Gold
SP Satin Platinum
HP High Polished Platinum
BP Burnished Platinum