

Butte (BU)
 with #4 Rosette

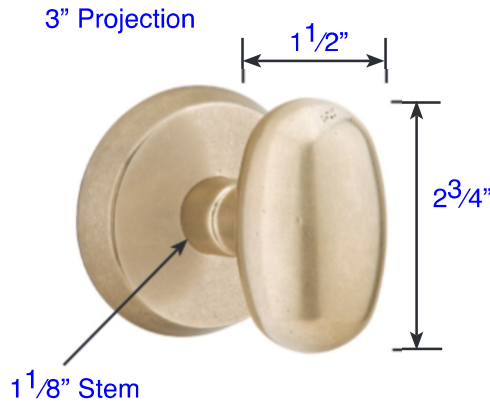

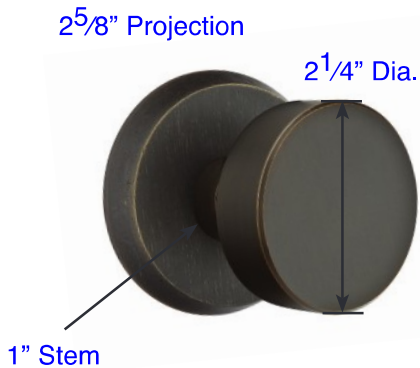



Bronze Egg (BZE)
 with #2 Rosette

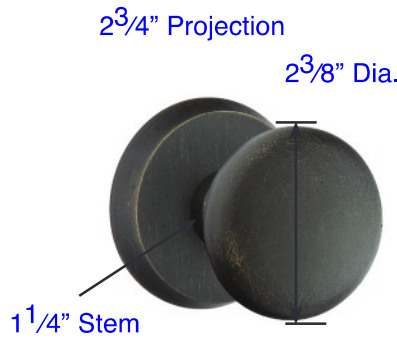

Round (BZRN)
 with #2 Rosette



Winchester (WC)
 with #2 Rosette

Rosettes	
1/16" Thick	<p>#1</p>  <p>4 1/2" x 2 1/2"</p>
	<p>#2</p>  <p>2 3/4" Dia.</p>
	<p>#3</p>  <p>4 1/2" x 2 1/2"</p>
1/2" Thick	<p>#4</p>  <p>4 1/2" x 2 13/16"</p>
1/16" Thick	<p>#6</p>  <p>2 1/2" x 2 1/2"</p>

Door Thickness Specifications

- Standard Door Thickness: 1 3/8" - 2"
- Standard Components:
 - Privacy Pin (for privacy sets)
 - Inside Passage Half Spindle
 - 1 1/2" Rosette Screws
 - Full-Lip Strike Plate

- **Extended** Door Thickness: 2" - 2 1/2"
- Extended Components:
 - Privacy Pin w/ Extension (for privacy sets)
 - Long Inside Passage Half Spindle
 - 2" Rosette Screws
 - Extended Full-Lip Strike Plate

- **Extended** Door Thickness: 2 1/2" - 3"
- Extended Components:
 - Privacy Pin w/ Extension (for privacy sets)
 - Extra Long Inside Passage Half Spindle
 - 2 1/2" Rosette Screws
 - Extended Full-Lip Strike Plate