

Contact Grill W.CT8 / W.CT8R



Product Information:

- Temperature regulation via thermostat (50°C - 250°C)
- Spring balanced upper plate limits crushing of product
- 12mm smooth aluminium plates (also available in 12mm aluminium ribbed top plate)
- Robust stainless steel construction
- Easy clean design with fully enclosed lifting assembly
- Removable grease tray to front

Specifications:

Model	W.CT8 / W.CT8.R
W x D x H (mm)	495 x 475 x 230
Cooking Area W x D (mm)	353 x 278
Capacity	6-8 Slices
Weight	25kg
Electrical Connection	240VAC / 50Hz / 2.2kW (10A plug & lead fitted)

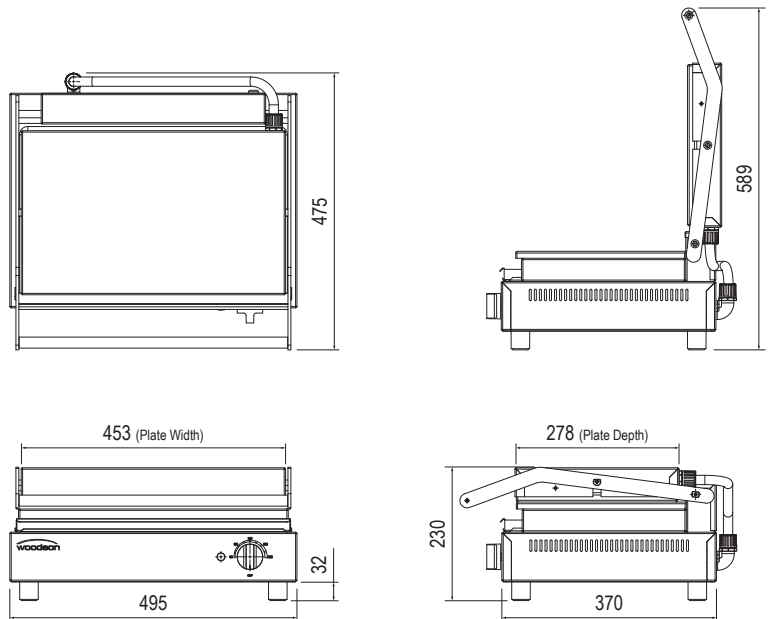

Due to continuous product research and development, the information contained herein is subject to change without notice.

Revision: C - 15/07/2022 - 04

www.stoddart.com.au

www.stoddart.co.nz