

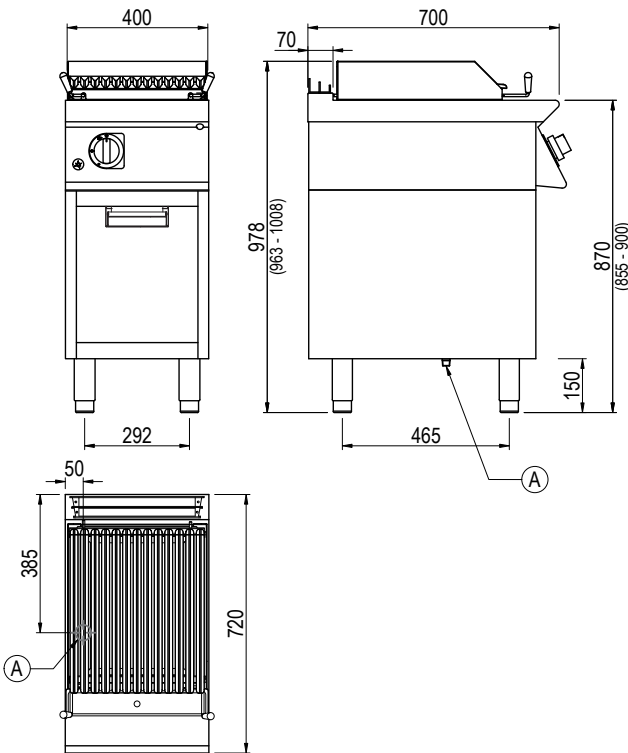

Product Information:

- Class leading, European style, professional quality and reliability since 1963
- 700 series, high performance gas char grill (28.8 MJ/h)
- Piezo ignition burners with flame failure device and pilot burner
- Temperature regulation via variable power flame control
- Lava stone rack over burners spreads and radiates heat while vaporising fats for that authentic char grill taste
- Supplied standard with specialised V-shaped meat char plate to capture and drain fat to front drip tray while providing defined char markings
- Supplied with removable internal grease tray, ash drawer and char plate
- Fish char plate sold separately (SPGI.2009337)
- Robust 304 grade stainless steel construction with rounded corners and splashguards
- Open base with optional door available (SPGI.2016437)
- Height adjustable stainless steel feet for a 900mm working height
- 24-month warranty

General Drawing:



Specifications:

Model	GL720GCT	
W x D x H (mm)	400 x 720 x 978	
Weight	75kg	
Packed Dimensions (mm)	450 x 825 x 1200	
Packed Weight (mm)	80kg	
Gas Connection	Natural 1/2" BSP	Universal LPG 1/2" BSP
Minimum Normal Test Gas Pressure	1.3 kPa	2.75 kPa
Maximum Normal Test Gas Pressure	3.5 kPa	3.5 kPa
Nominal Test Point Pressure	1.0 kPa	2.65 kPa
Total Nominal Gas Consumption	28.8 MJ/h	28.8 MJ/h

Note: It is the responsibility of the installing gas plumber to ensure correct supply and connection sustaining appropriate pressure, when all installed gas appliances are operating at maximum.

Legend:

A Gas Connection

Due to continuous product research and development, the information contained herein is subject to change without notice.

Revision: A - 07/12/2023 - 03

www.stoddart.com.au

www.stoddart.co.nz

