

u h u r u
WORKPLACE

MINIM OFFICE



INTELLIGENCE WITHOUT AMBITION IS A BIRD WITHOUT WINGS.

-
Salvador Dali



OUR PURPOSE

In setting out to design our Workplace collection, we weren't seeking to change the way we work, rather, our goal was to elevate how we work – to design a product that enhances the experience and productivity of those who use it by infusing it with the same genuine design and material sensibility our Brooklyn studio has become known for.

We believe that a commitment to craft, style and authenticity is as important in the workspace as it is in our homes. With the balance between work and home continuing to evolve, we sought to create a product that reflects the growing awareness in our society of the products we use and the spaces we inhabit.

Striking a balance between minimalism, bespoke design and classic angular proportions, this collection reflects this belief; its rich materiality incorporated into clean, contemporary and easily adaptable forms for a refined simplicity suitable for the next generation of workplace design.

Jason Horvath
Founders, Uhuru Design

Bill Hilgendorf





LEG PROFILES

Surface

D 29.5" | 750 mm

Bench

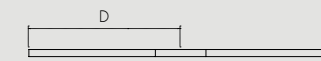

Desk

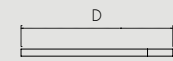

Split

BW 38" | 967mm
H 29.5" | 750mm

BW 23.5" | 597mm
H 29.5" | 750mm

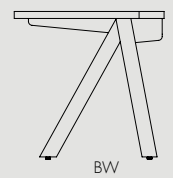
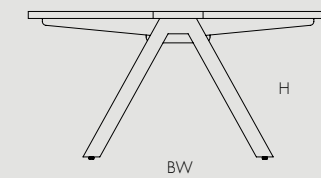

Broad

BW 31.5" | 799mm
H 29.5" | 750mm

BW 25" | 637mm
H 29" | 750mm

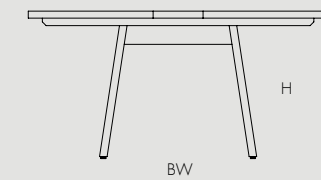

Square

BW 59.5" | 1511mm
H 29.5" | 750mm

BW 29" | 743mm
H 29.5" | 750mm

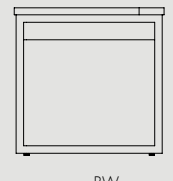
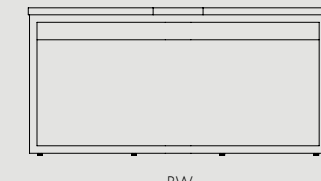





CONFIGURATIONS

Standard Bench

W 47.25" | 1200mm

W 59" | 1500mm

W 71" | 1800mm

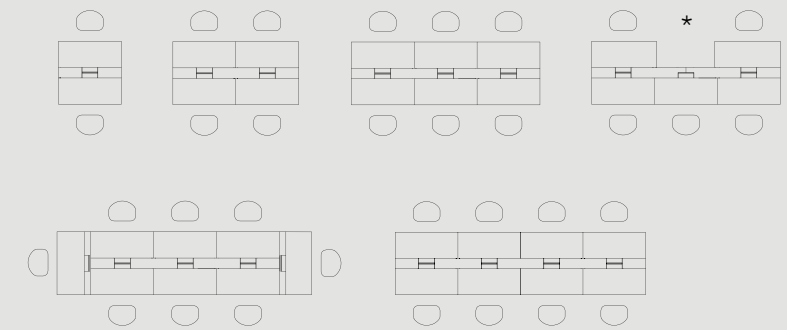

**Surface can be removed to adapt to your space.*

Standard Desk

W 47.25" | 1200mm

W 59" | 1500mm

W 71" | 1800mm

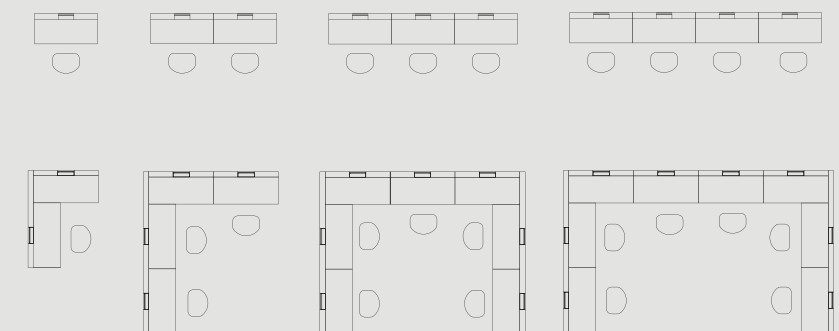





STORAGE

Designed to incorporate seamlessly into the desk system, our cabinet and pedestal options also have the design integrity to stand or mount on their own.

UHURU CONTRACT



STORAGE OPTIONS

High Cabinet

L 29.5" D 18.75" H 41.6"
L 750mm D 476mm H 1056mm

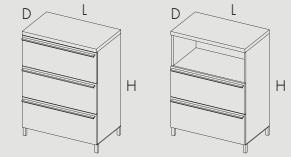

Low Cabinet

L 29.5" D 18.75" H 29.5"
L 750mm D 476mm H 750mm

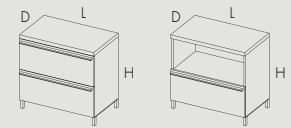

Double Low Cabinet

L 59" D 18.75" H 29.5"
L 1500mm D 476mm H 750mm

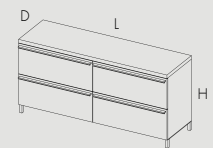

Rolling Pedestal

L 15" D 20.75" H 25"
L 381mm D 527mm H 635mm

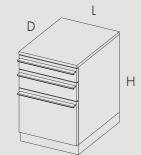

Low Pedestal

Drawers available on right or left side.

L 36" D 15.75" H 20"
L 914mm D 400mm H 508mm

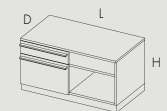

Overhead Cabinet

L 47.25" D 13" H 15"
L 1200mm D 330mm H 381mm

L 59" D 13" H 15"
L 1500mm D 330mm H 381mm

L 71" D 13" H 15"
L 1800mm D 330mm H 381mm

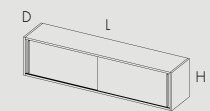

Extension Cabinet

Only available for the bench system.

L 59" D 13" H 15"
L 1500mm D 330mm H 381mm

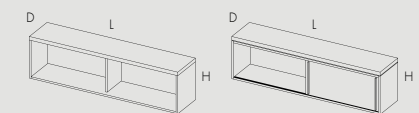



ACCESSORIES

Dividers

Glass Divider and Post

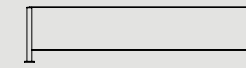

Felt Divider and Post

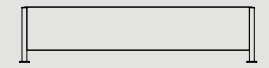

Accessories

Side-to-Side Divider

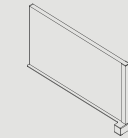

Low Pedestal Cushion

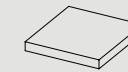

Modesty Panel

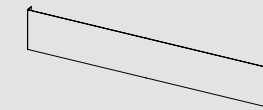

Power Panels





FINISHES

Top



1 2



3 4 5

Base

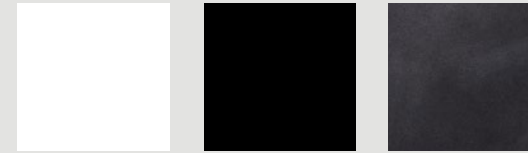

1 3 4

Storage

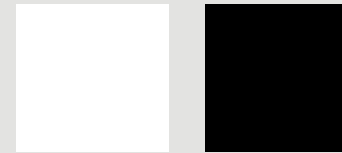

1 3

Divider



1 2 3

Composite

- 1 White
- 2 Black

Wood

- 3 Natural Oak
- 4 Whitewashed Ash
- 5 Natural Walnut

Metal

- 1 White
- 3 Black
- 4 Uhuru Black

Lacquer

- 1 White
- 3 Black

Felt

- 1 Natural
- 2 Gray
- 3 Charcoal



POWER AND DATA

MINIM OFFICE comes equipped with two removable panels on each intermediate leg to accommodate wires from flush-mount floor cores. Designed to direct and conceal wires into the workstations, the center channel is designated for power and the outer channels for data. Once fed through the leg the wires can navigate through the troughs for easy installation.

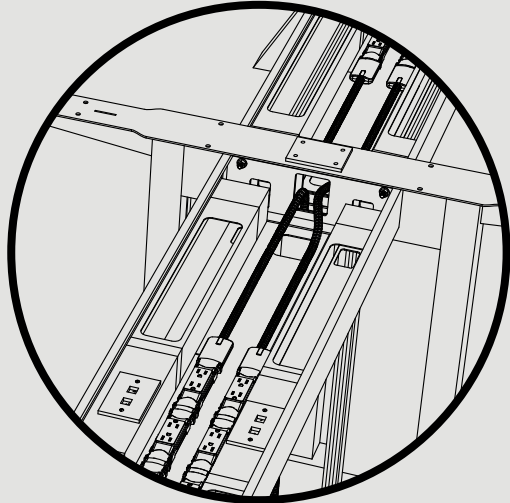
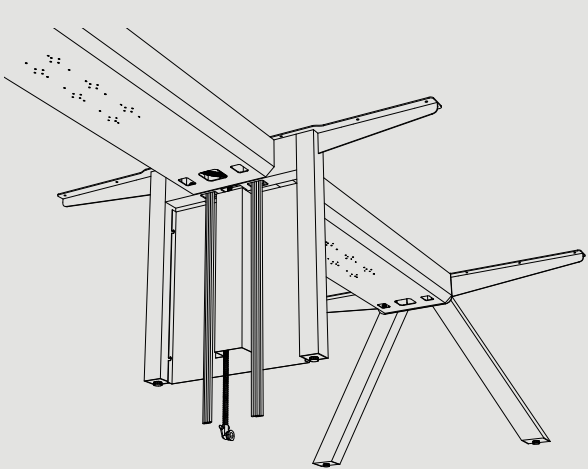

If running electrical from a wall, our system is equipped with three holes at the bottom of each trough; the center for power and the outer two holes for data. Wires can then be fed under the leg and up through the trough cut-outs for easy installation with no drilling required.

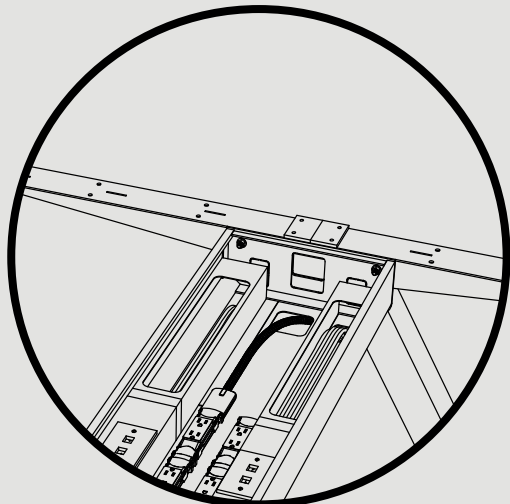
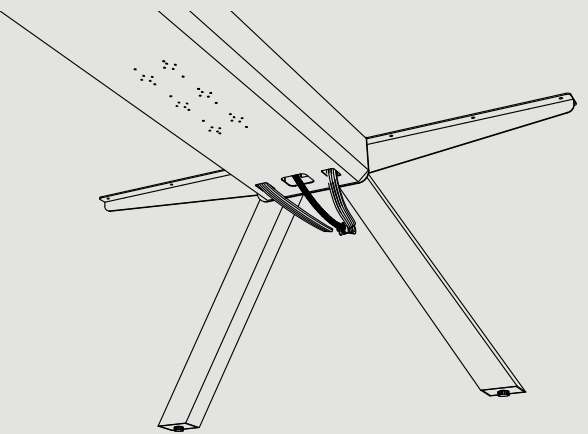



u h u r u

185 Van Dyke St.
Brooklyn, NY 11231
718 855 6519

Copyright © 2019 Uhuru Design

UHURUCONTRACT.COM
UHURUDESIGN.COM

info@uhurudesign.com

040219

u h u r u

@uhurudesign