

u h u r u

MINIM RISE

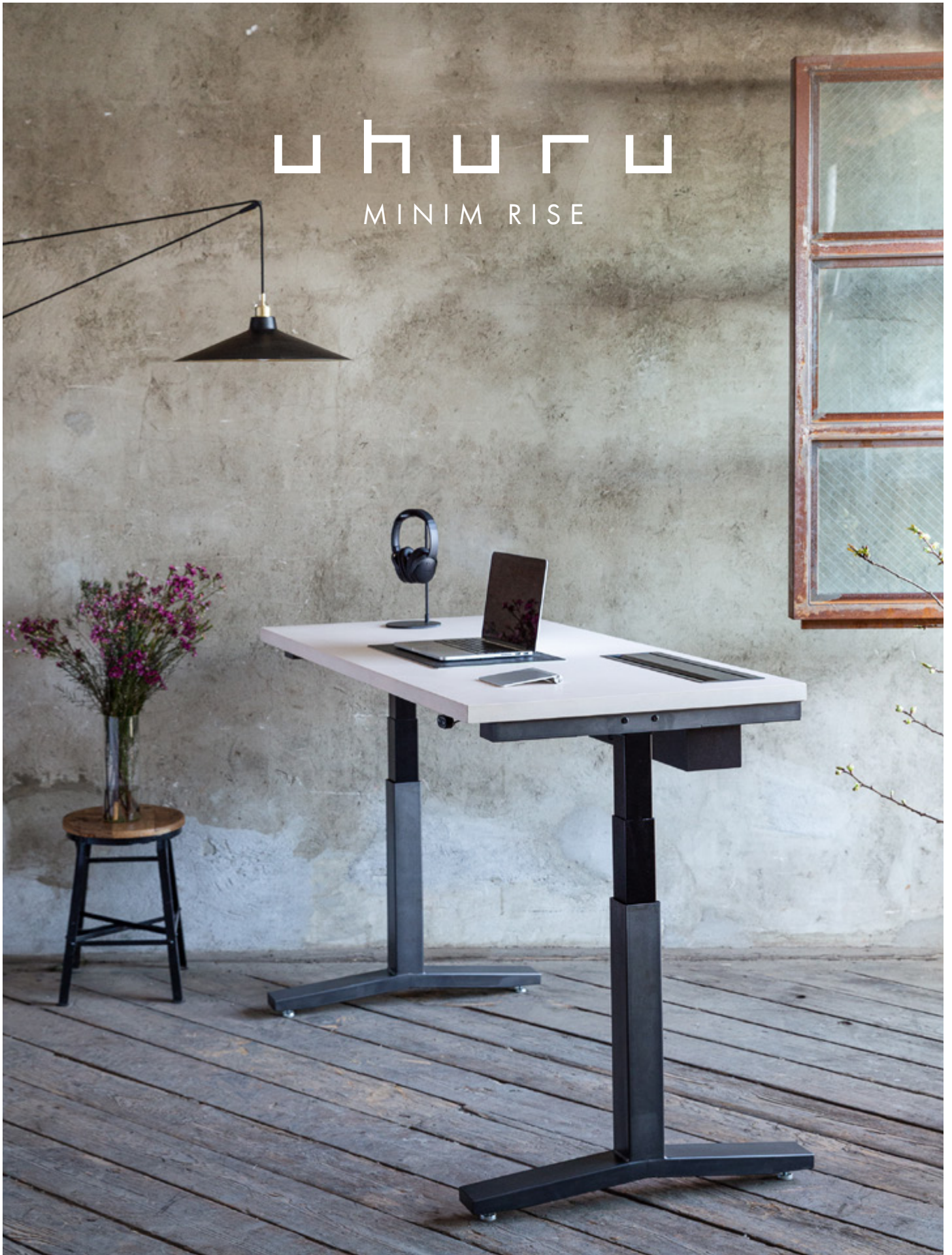



## MINIM RISE SIT-STAND DESK SYSTEM

The Minim Rise Sit-Stand Desk incorporates the industry leading electronic lift system into a robust steel base, seamlessly concealed beneath its surface, which is available in a range of curated finishes. This system has the unique ability to offer both fixed height and sit-stand capabilities into one workstation. For additional convenience power, we offer a desktop power unit that can be integrated into the surface trough.



\* Optional desktop convenience trough and power

## MINIM RISE SIT-STAND DESK

# MINIM RISE SIT-STAND DESK

## STATEMENT OF LINE

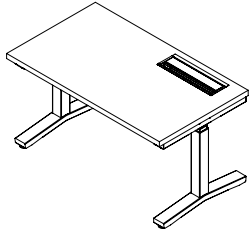

Single Desk 47.25"  
DSS4801

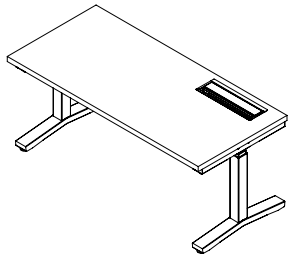
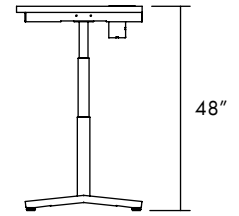
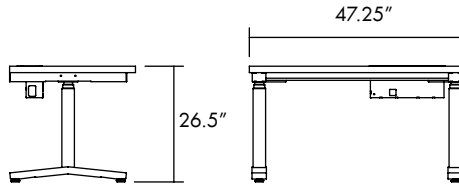
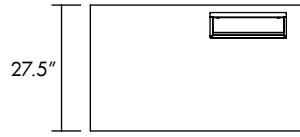

Single Desk 59"  
DSS5901

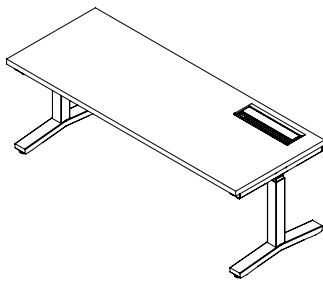
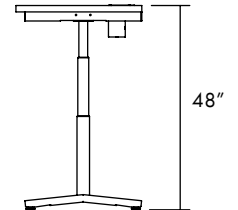
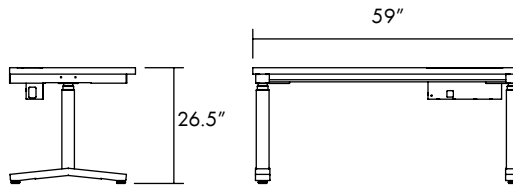
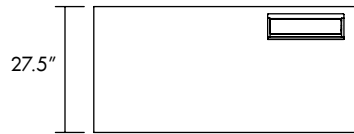

Single Desk 71"  
DSS7101

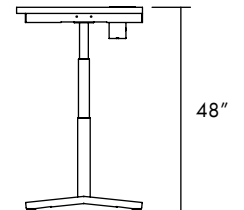
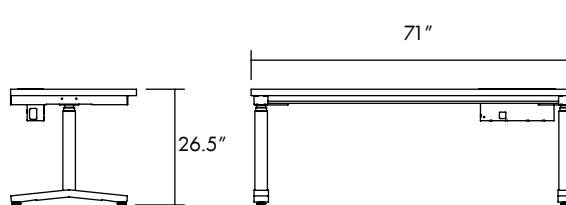
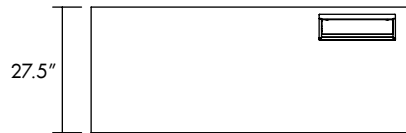

## POWER

The Minim Rise Sit-Stand Desk comes with an optional surface trough. For additional convenience power, we offer a desktop power unit that can be integrated into the surface trough.

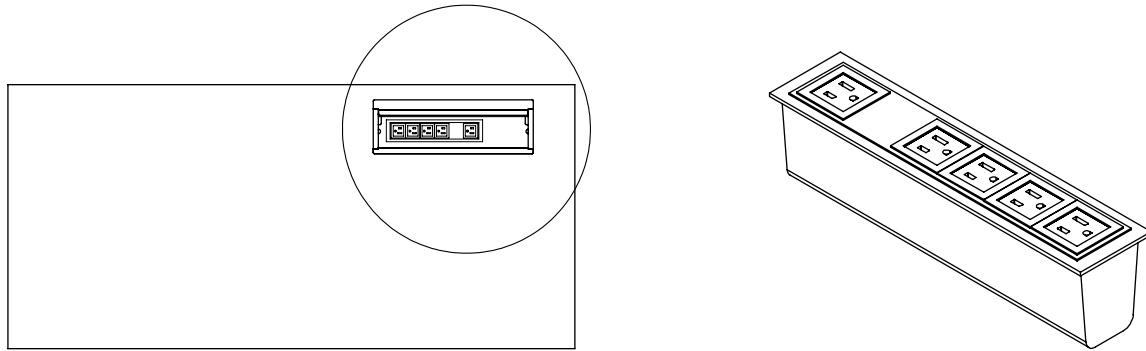

## WIRE MANAGEMENT

The desk is designed with a specially engineered frame that cleverly consolidates and conceals the lifter's power cords and gives the option to have the cable exit any corner of the desk.

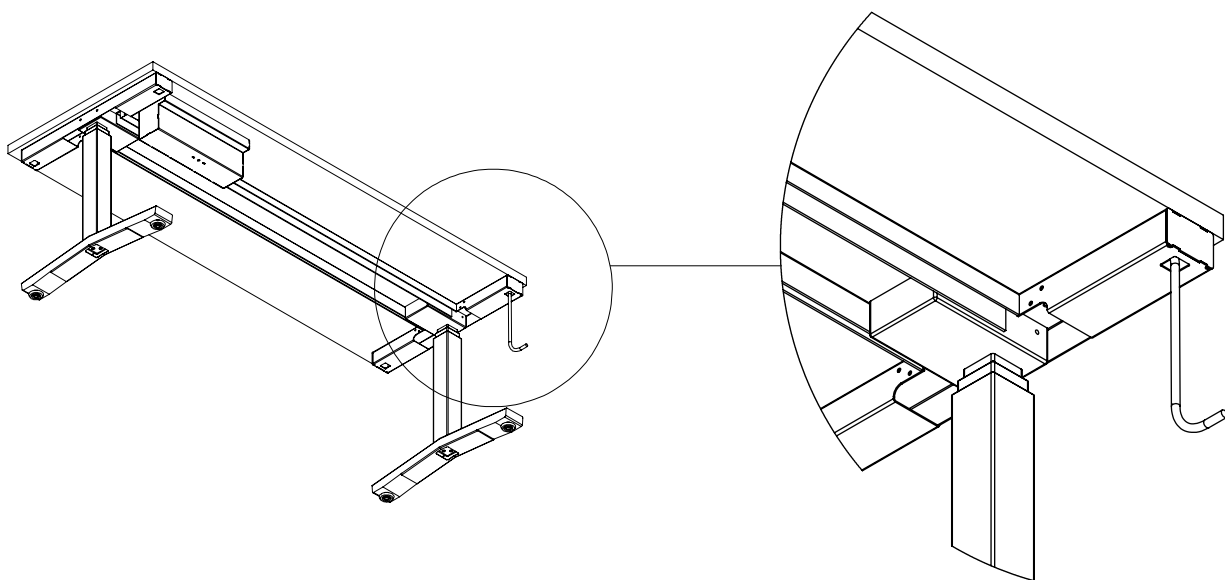

*\* Underside of single sit-stand desk*



## LIFTER COMPONENTS

Minim Rise offers the choice of a fixed height column kit or a height adjustable column kit. Everything needed to operate is included; both come ready-to-use out of the box. The lifter kit includes a standard control switch, power box, power cable and a pair of dual stage lifting columns.

### FIXED HEIGHT COLUMN KIT

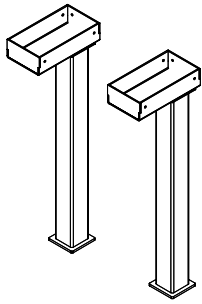

Fixed Columns x2

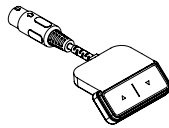

Paddle Switch

### HEIGHT ADJUSTABLE COLUMN KIT

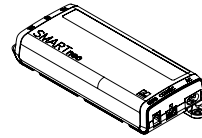

Power Box

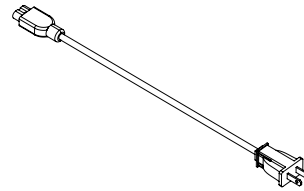

Power Cable

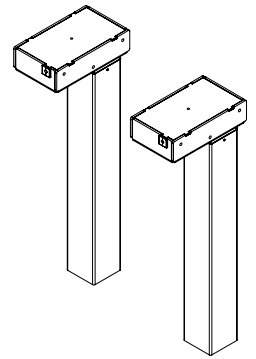

Lifter Columns x2

## FINISHES

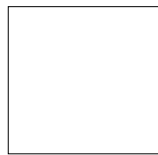

1



2

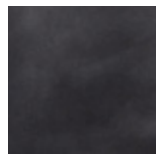

3

### BASE

1. White
2. Black
3. Uhuru Black

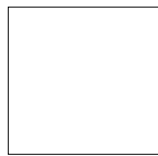

3



4

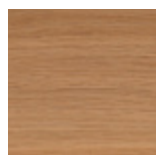

5

### SURFACE

3. White Laminate
4. Black Laminate
5. Natural Oak
6. Natural Walnut
7. White Washed Ash

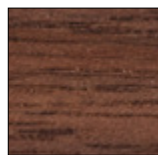

6

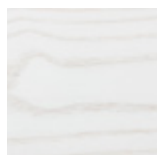

7