

# LIQUEUR TABLE

LQ\_TB.120x90

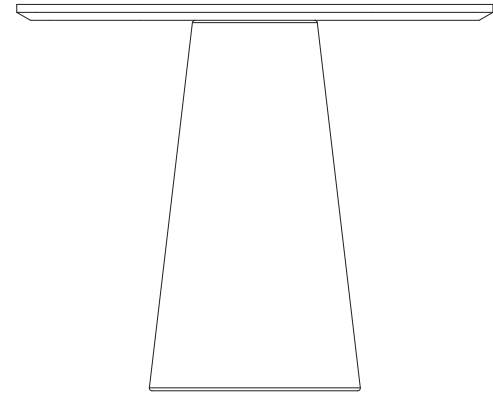
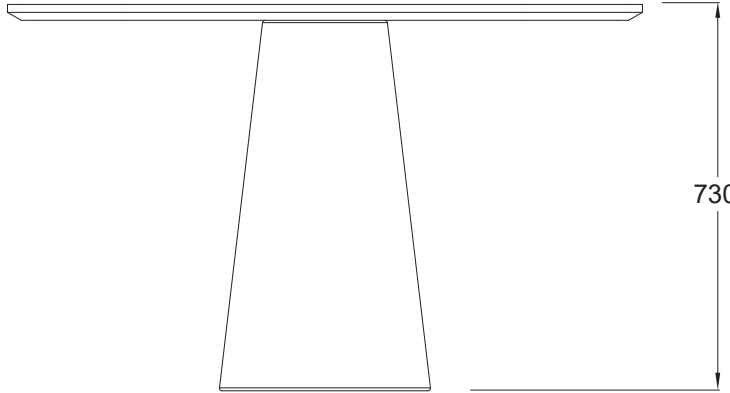
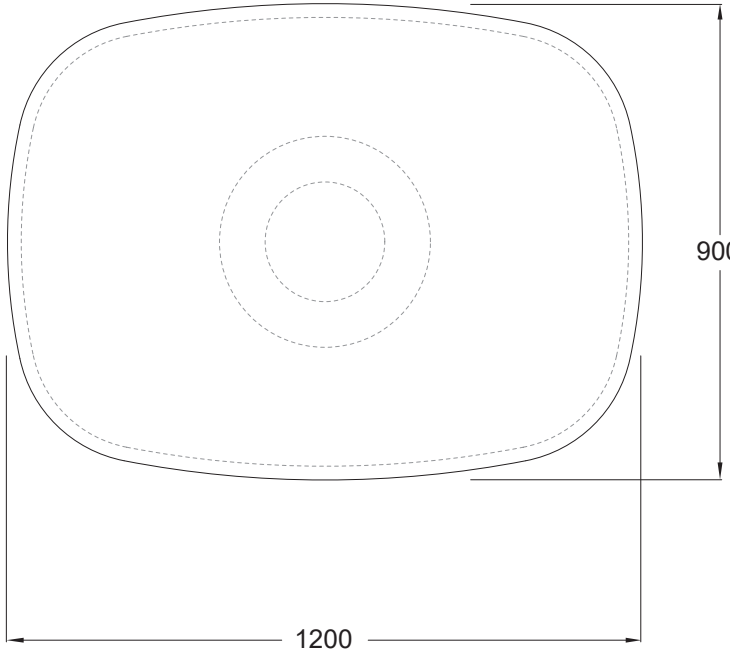

# LIQUEUR TABLE

LQ\_TB.180x90

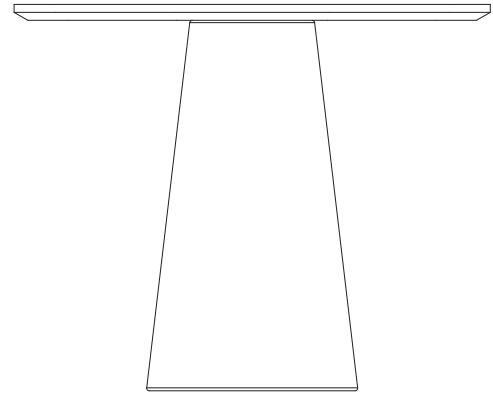
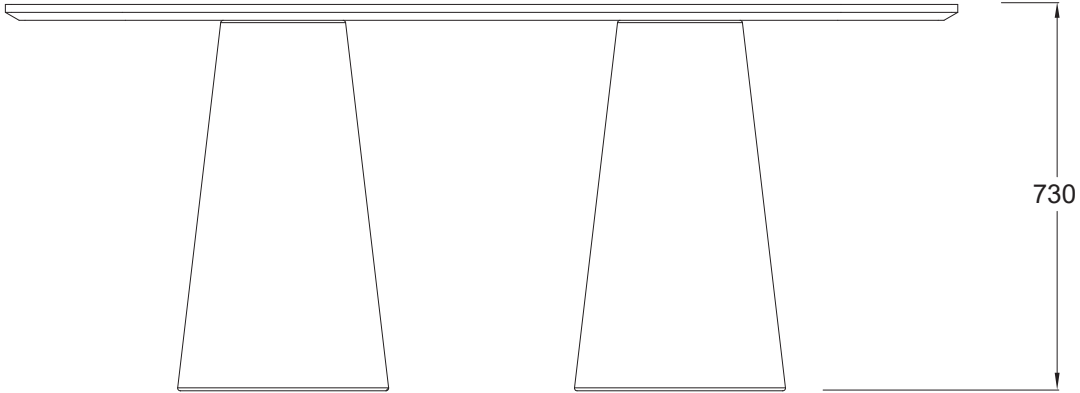
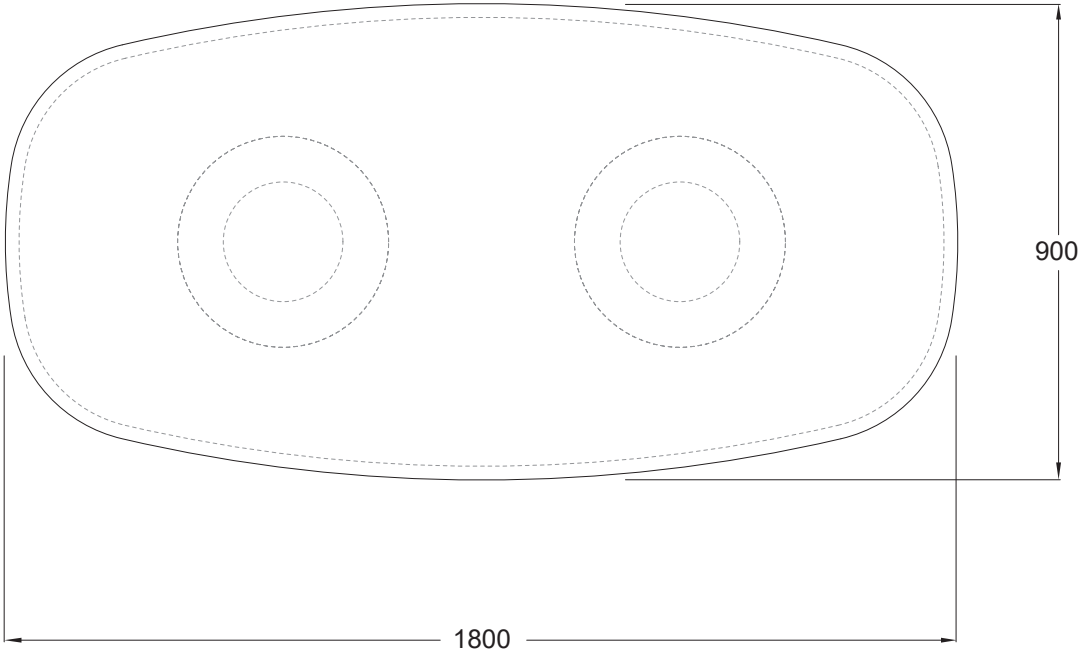

# LIQUEUR TABLE

LQ\_TB.210x90

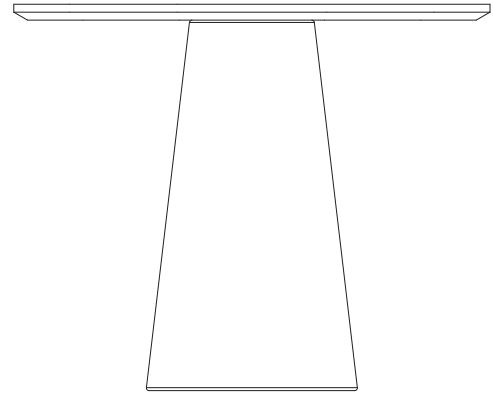
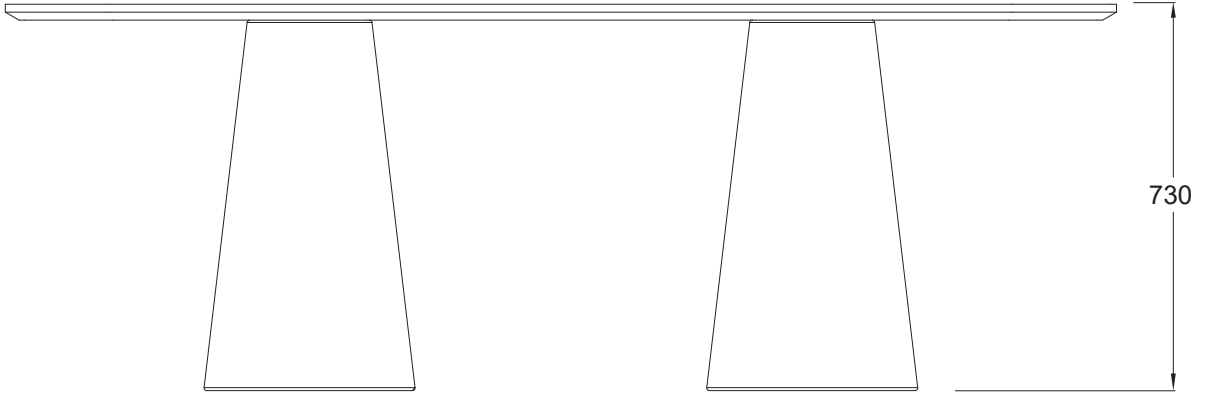
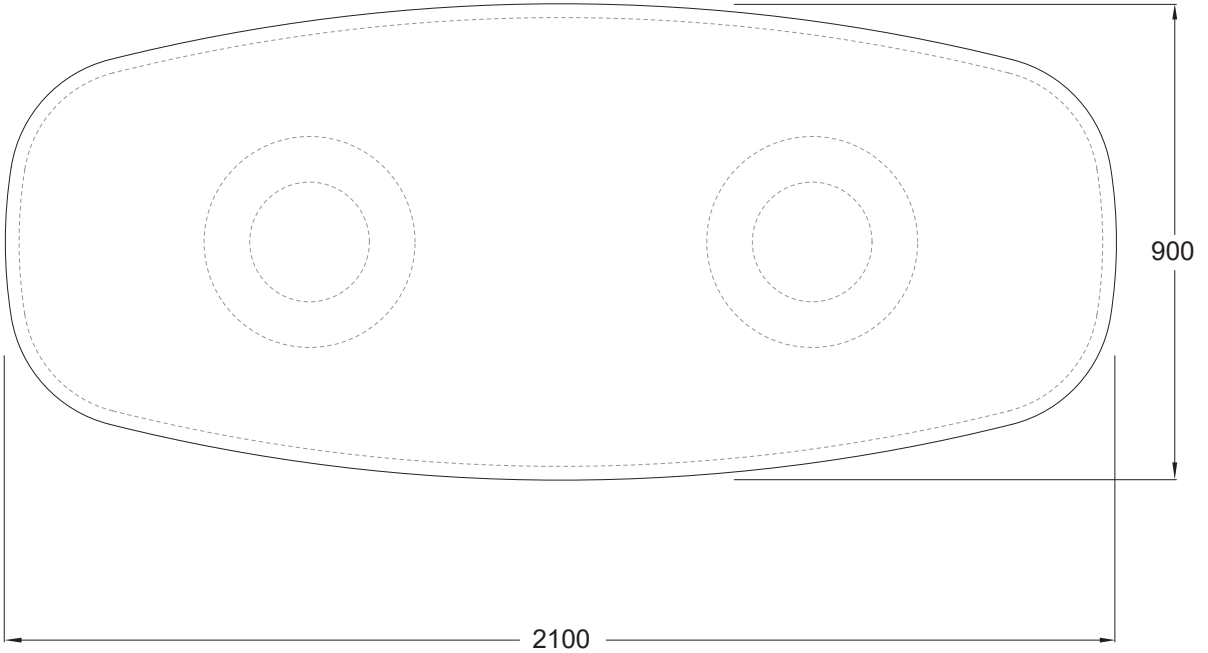

# LIQUEUR TABLE

LQ\_TB.240x90

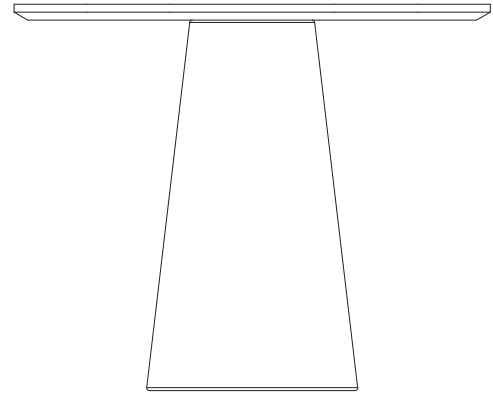
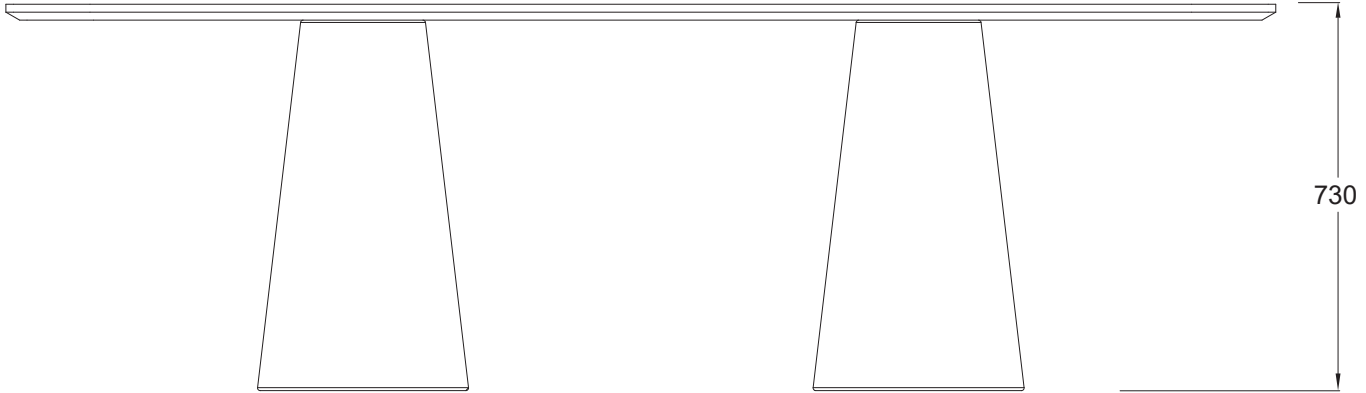
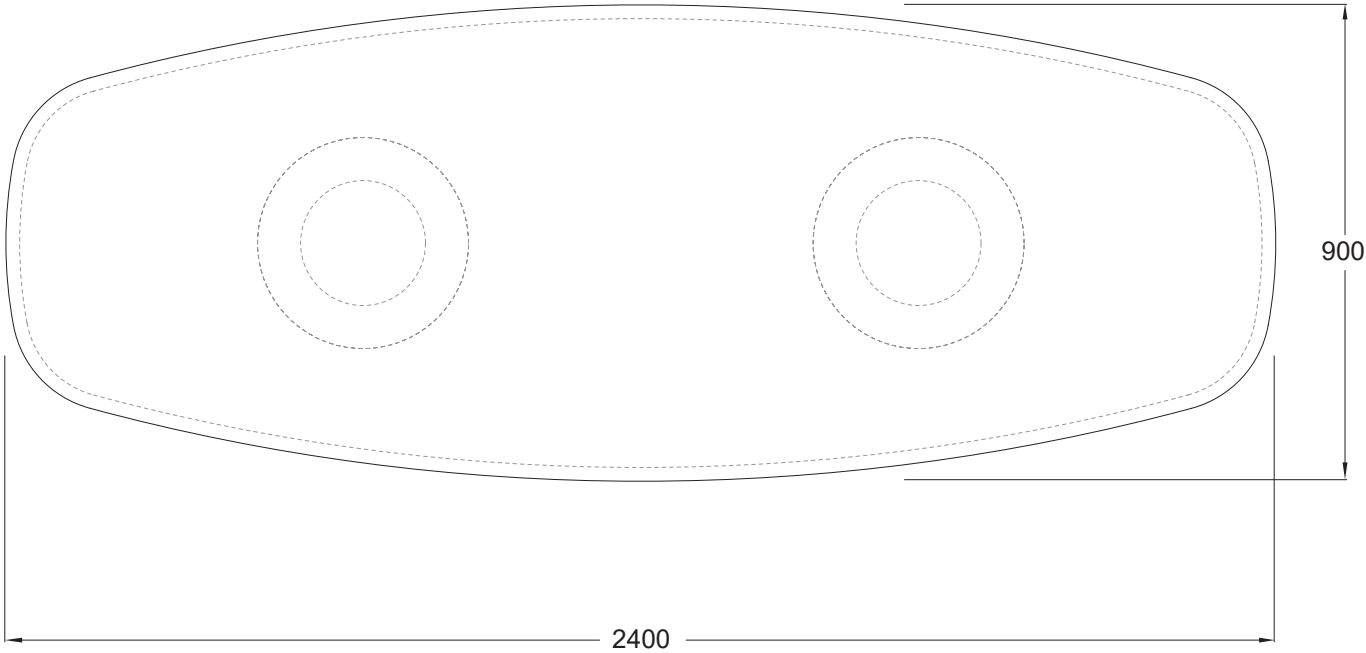



# LIQUEUR TABLE

LQ\_TB.270x90

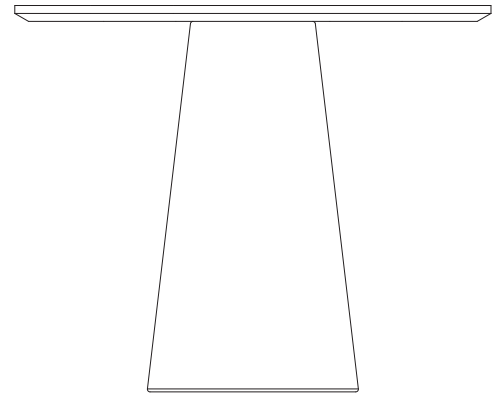
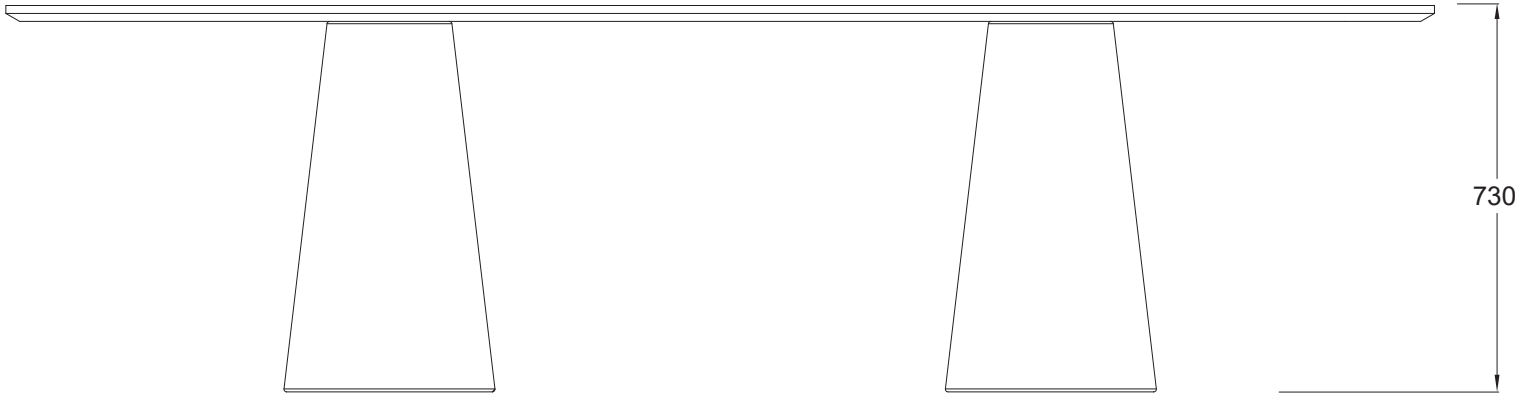
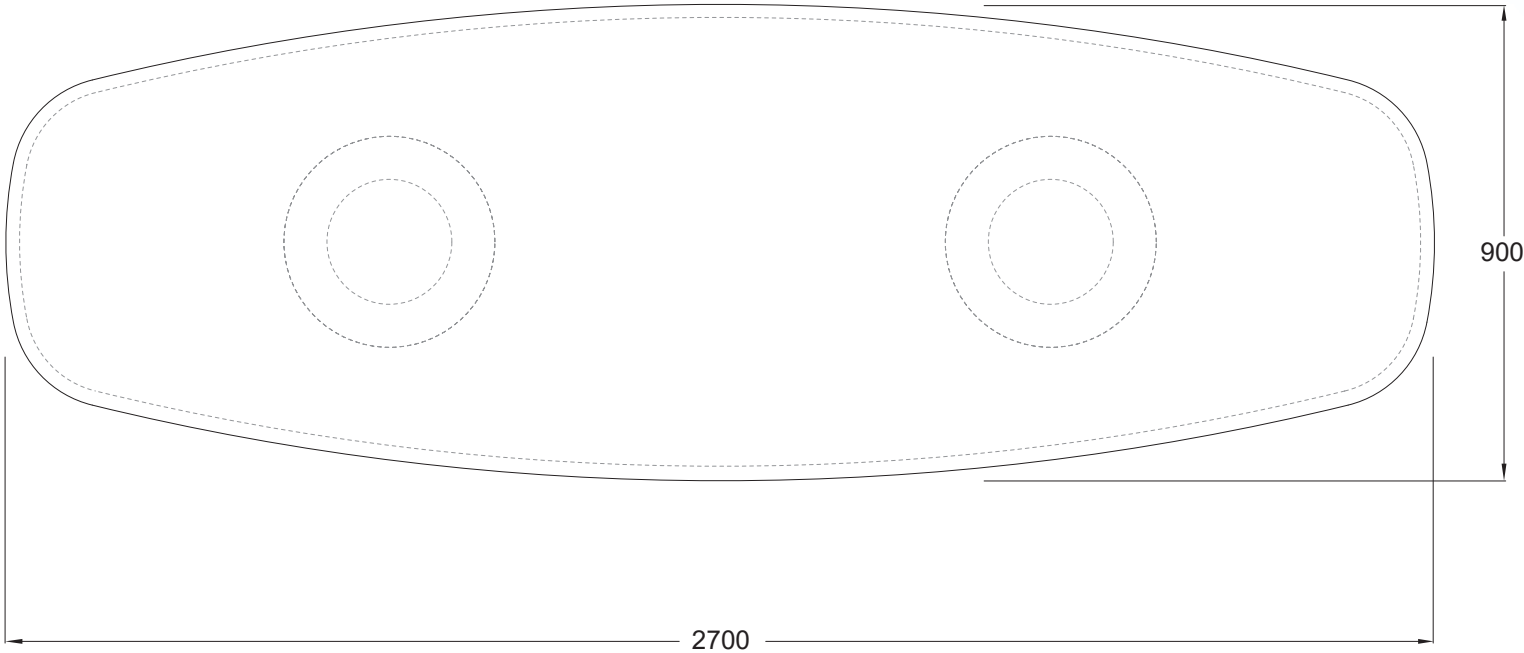

# LIQUEUR TABLE

LQ\_TB.180x90[RECT]

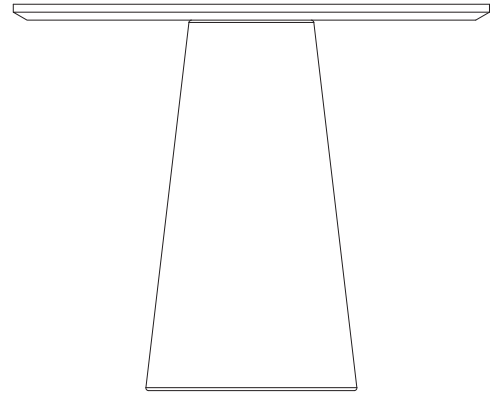
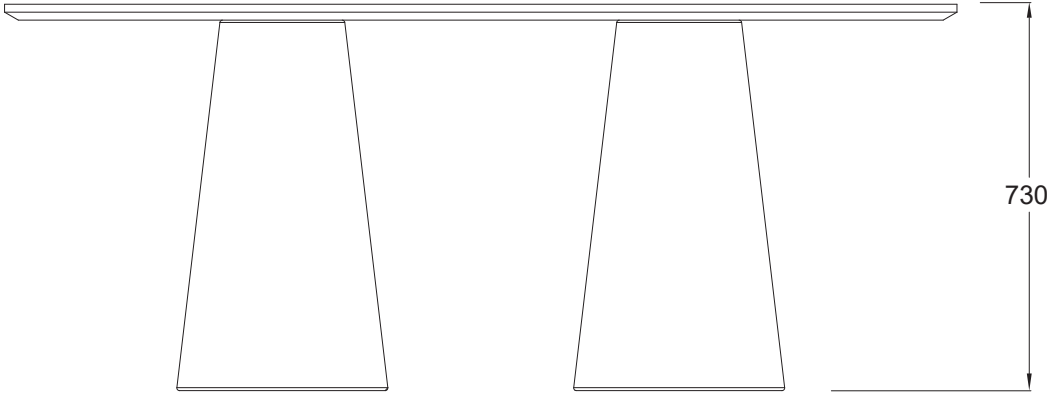
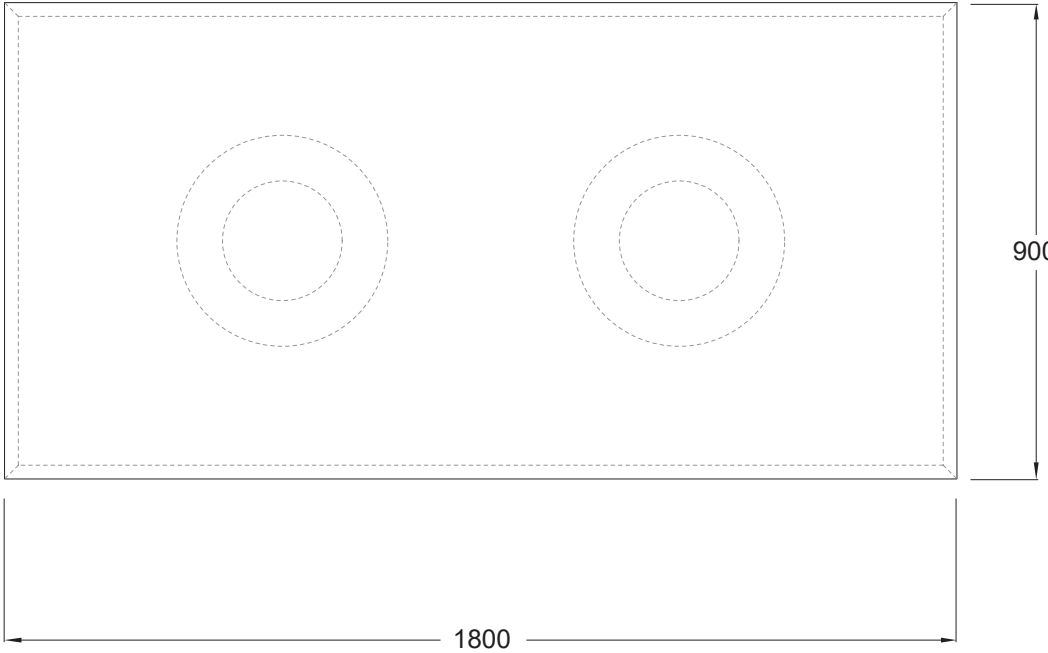

# LIQUEUR TABLE

LQ\_TB.210x90[RECT]

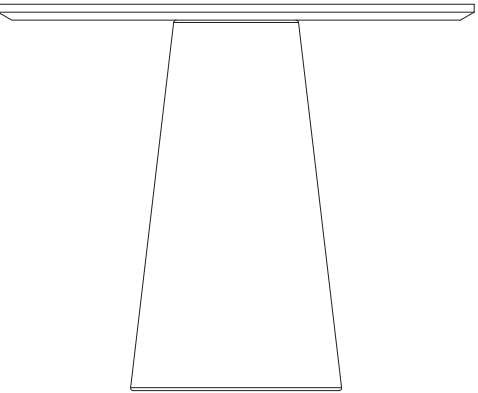
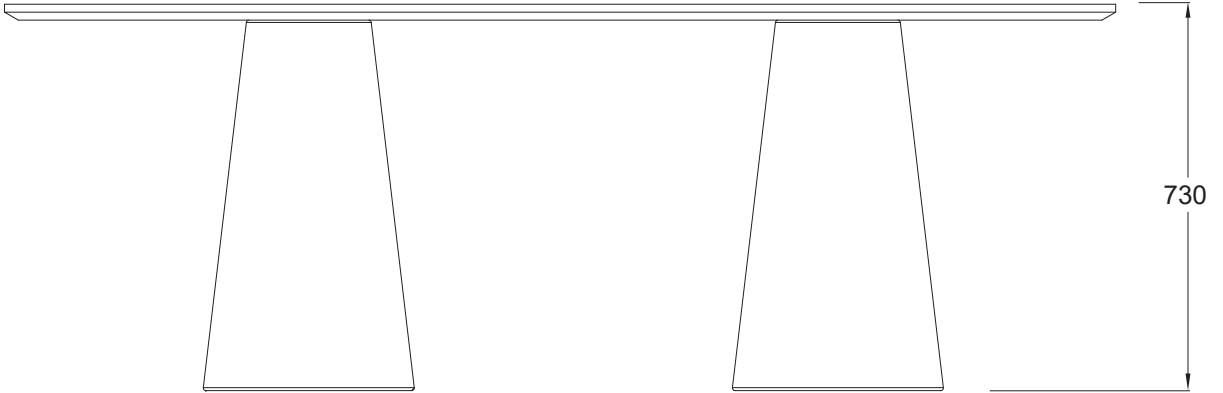
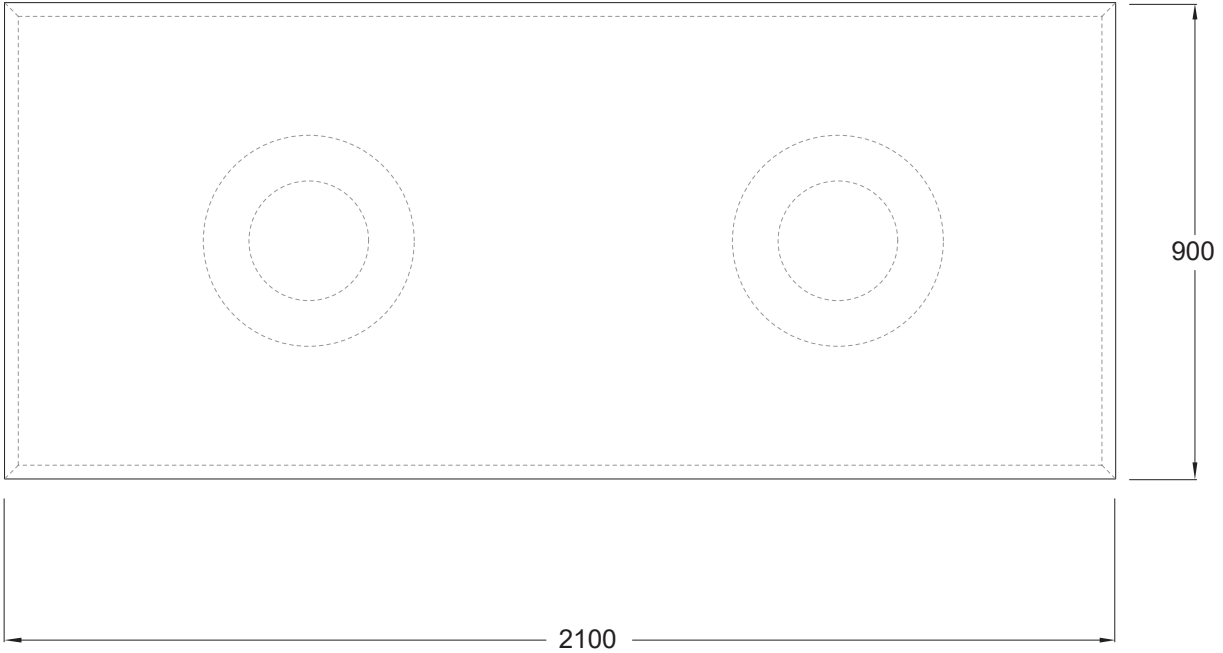

# LIQUEUR TABLE

LQ\_TB.240x90[RECT]

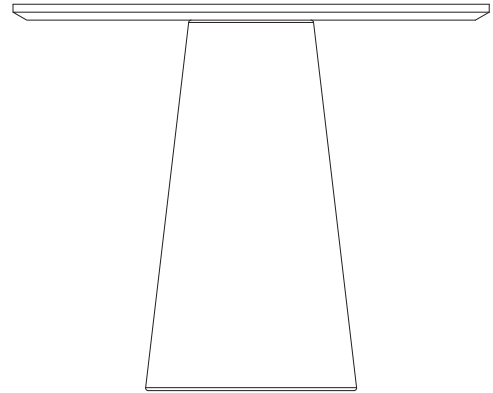
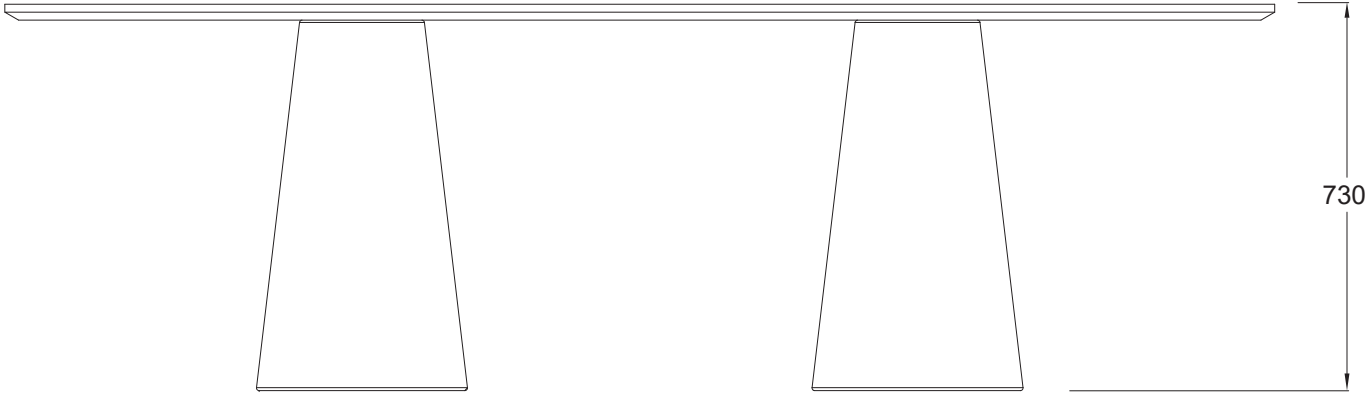
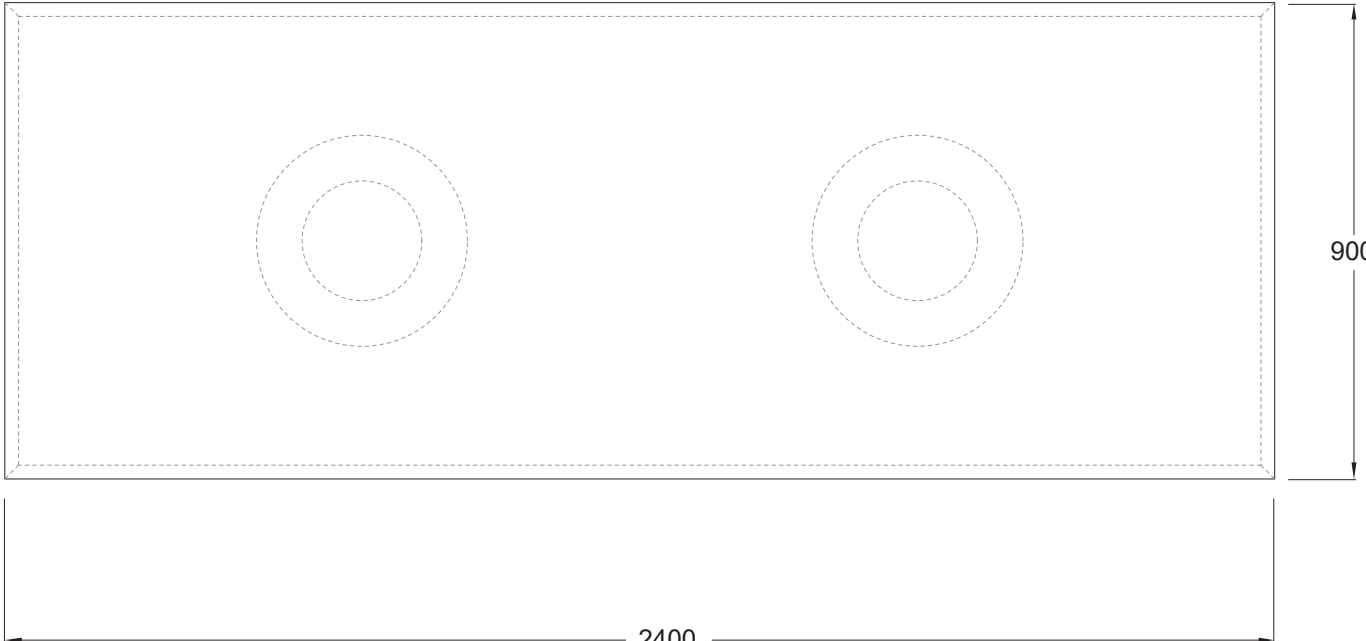

# LIQUEUR TABLE

LQ\_TB.270x90[RECT]

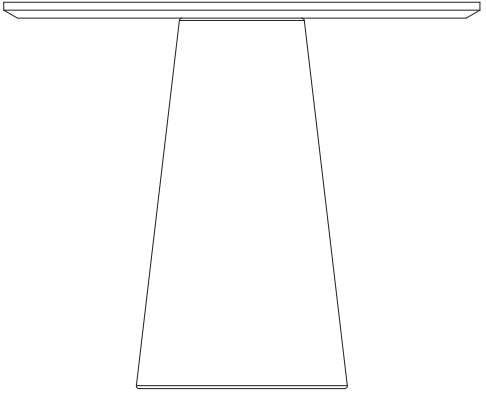
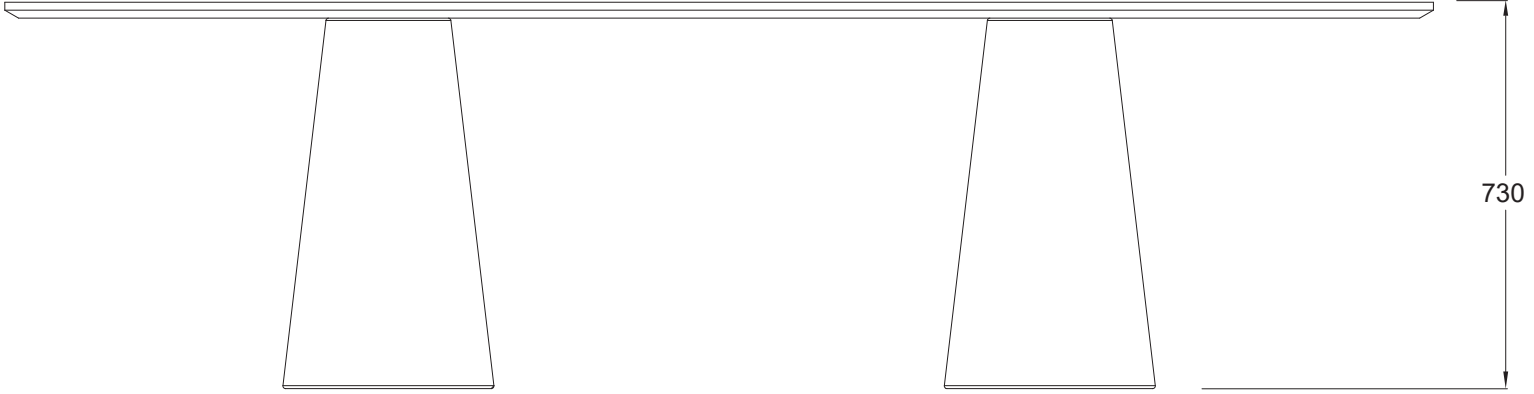
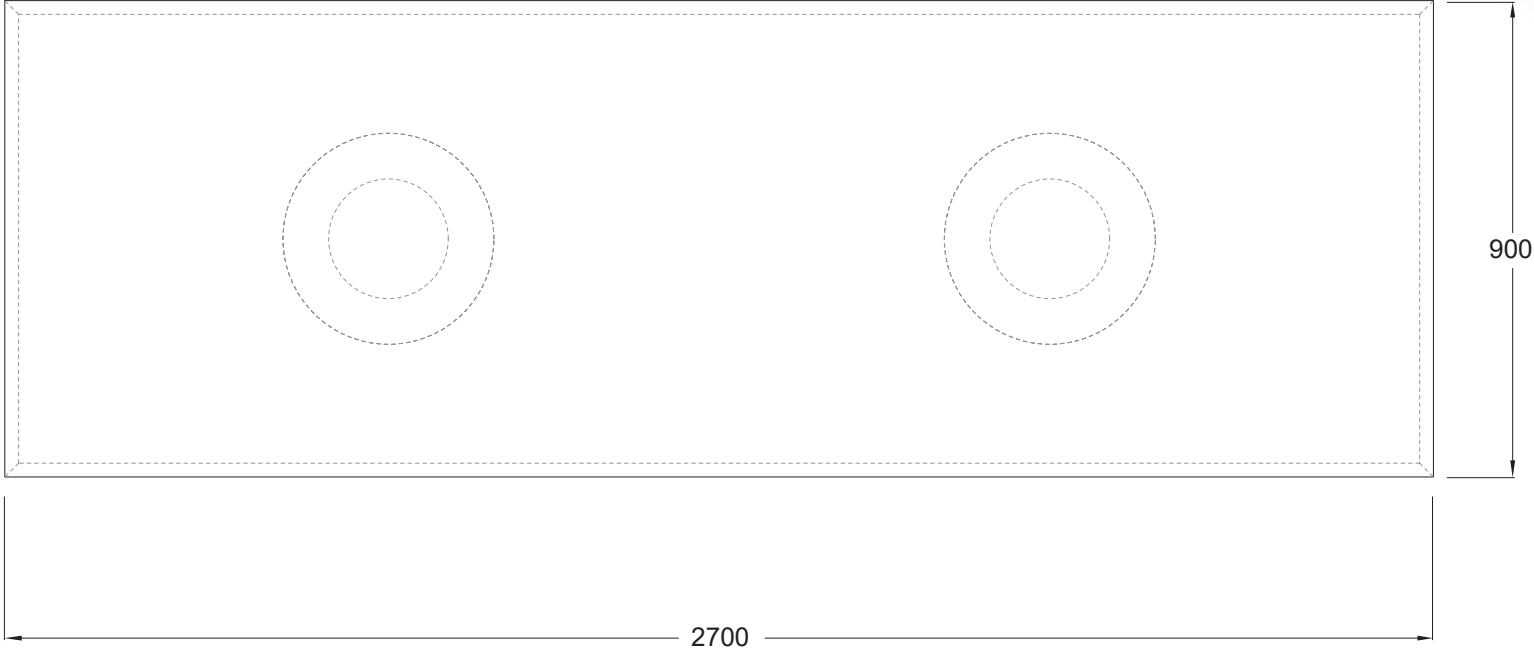

# LIQUEUR TABLE

LQ\_TB.80x80[SML]

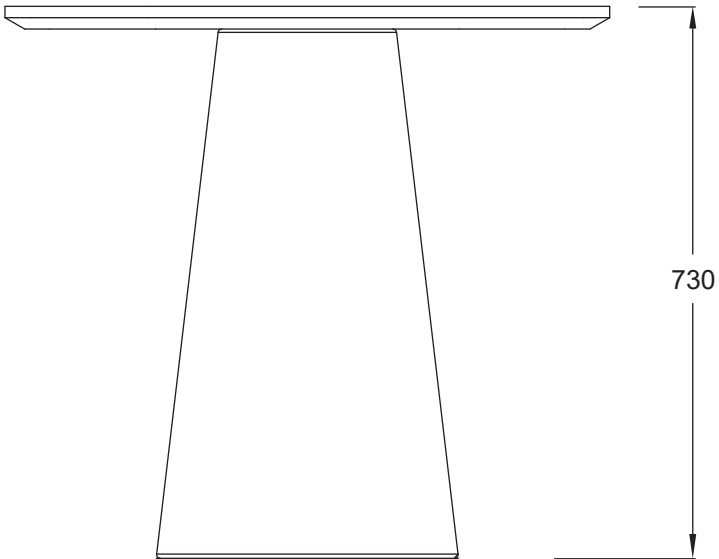
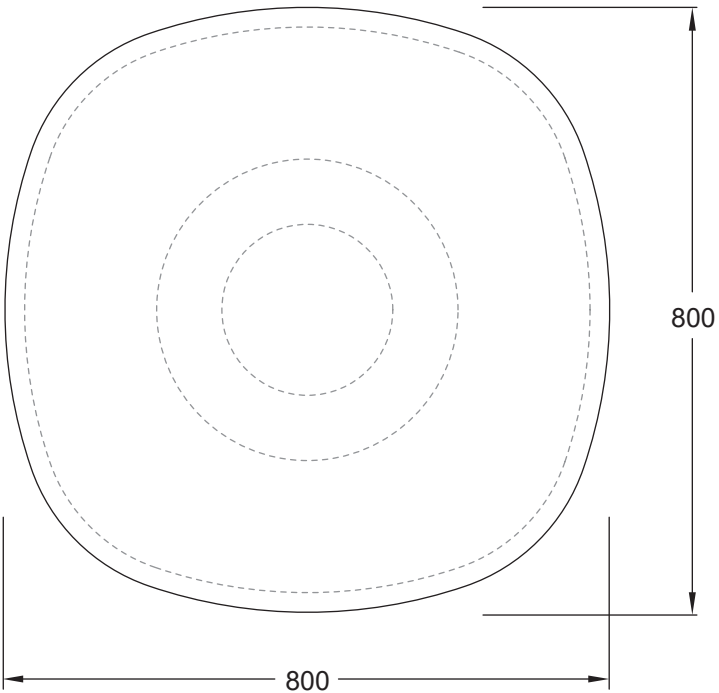

# LIQUEUR TABLE

LQ\_TB.105x105[SML]

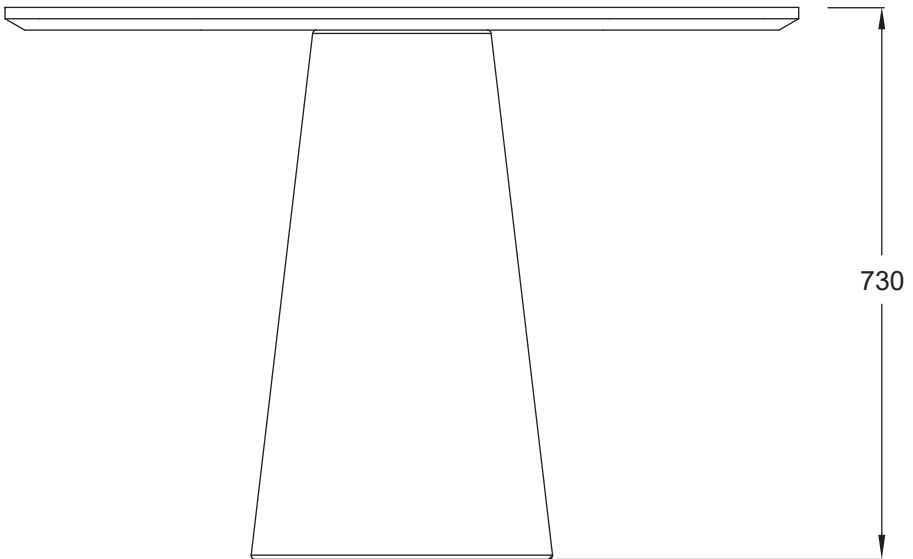
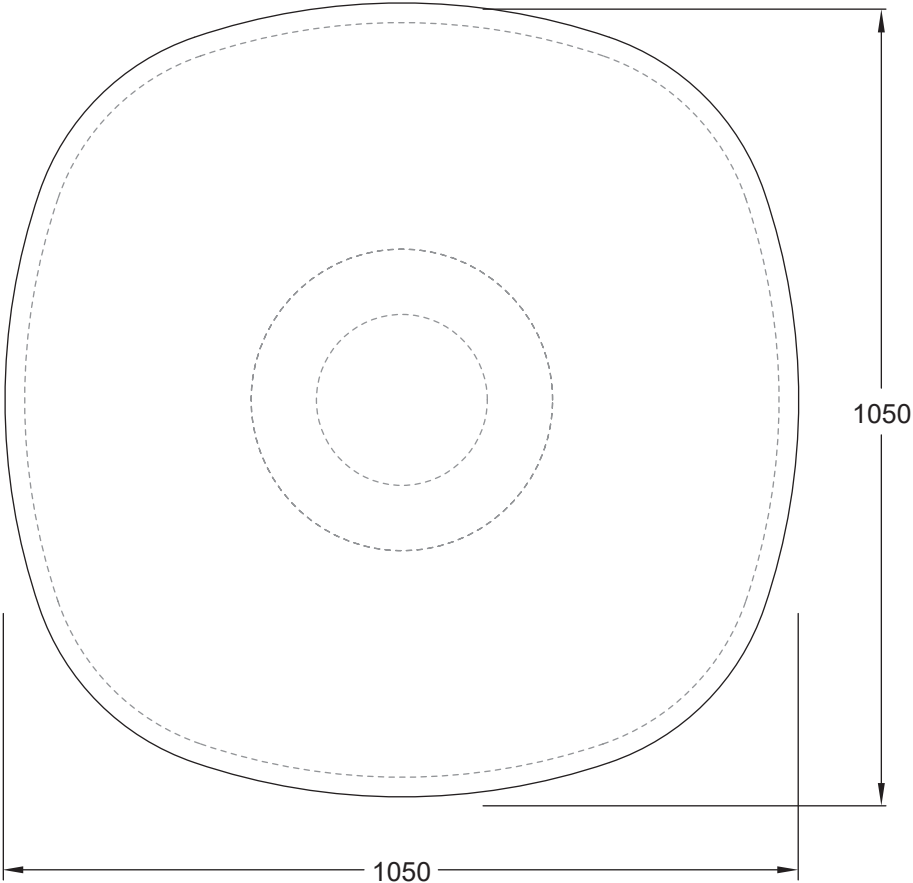

# LIQUEUR TABLE

LQ\_TB.120x90

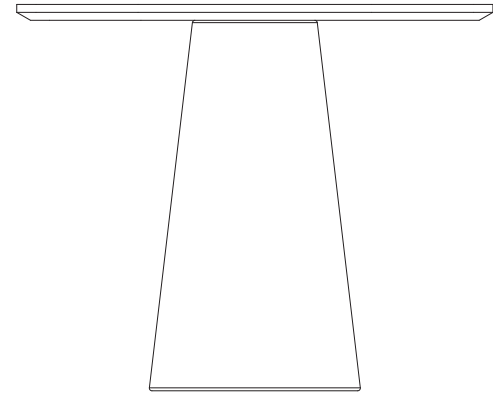
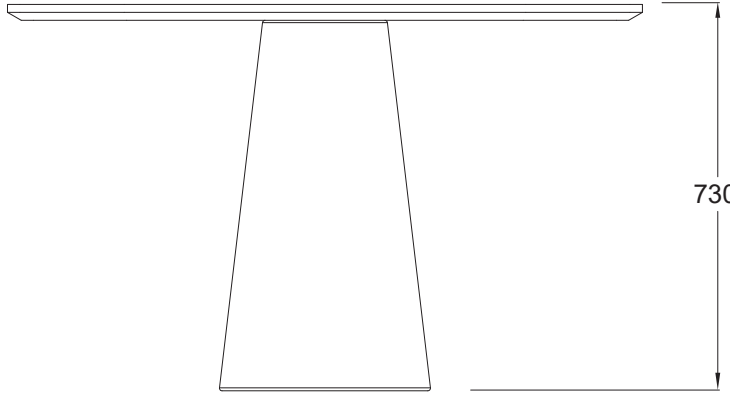
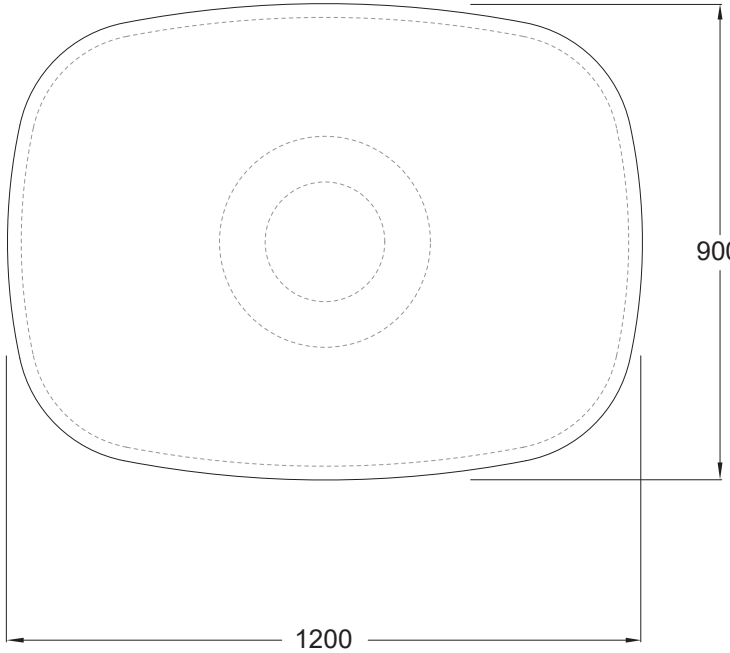



# LIQUEUR TABLE

LQ\_TB.180x90[RECT]

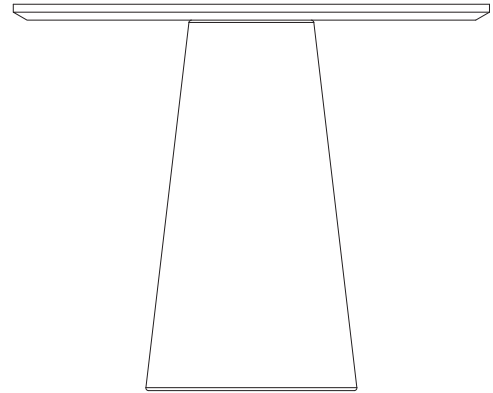
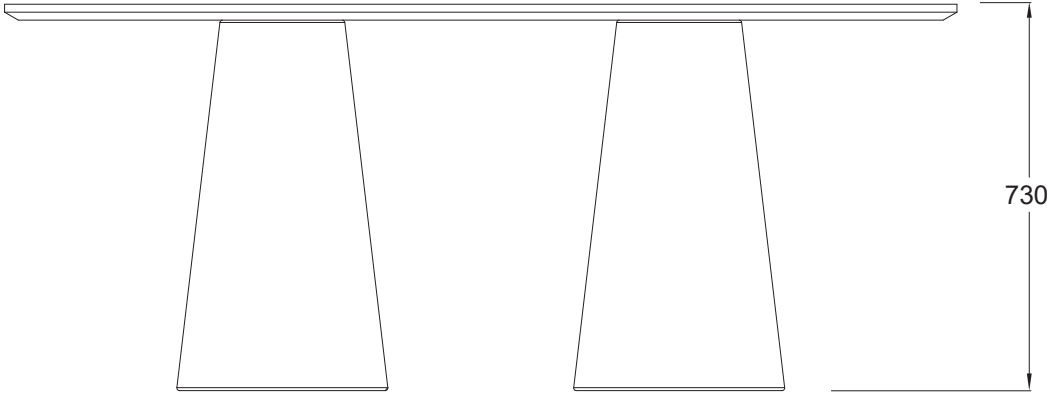
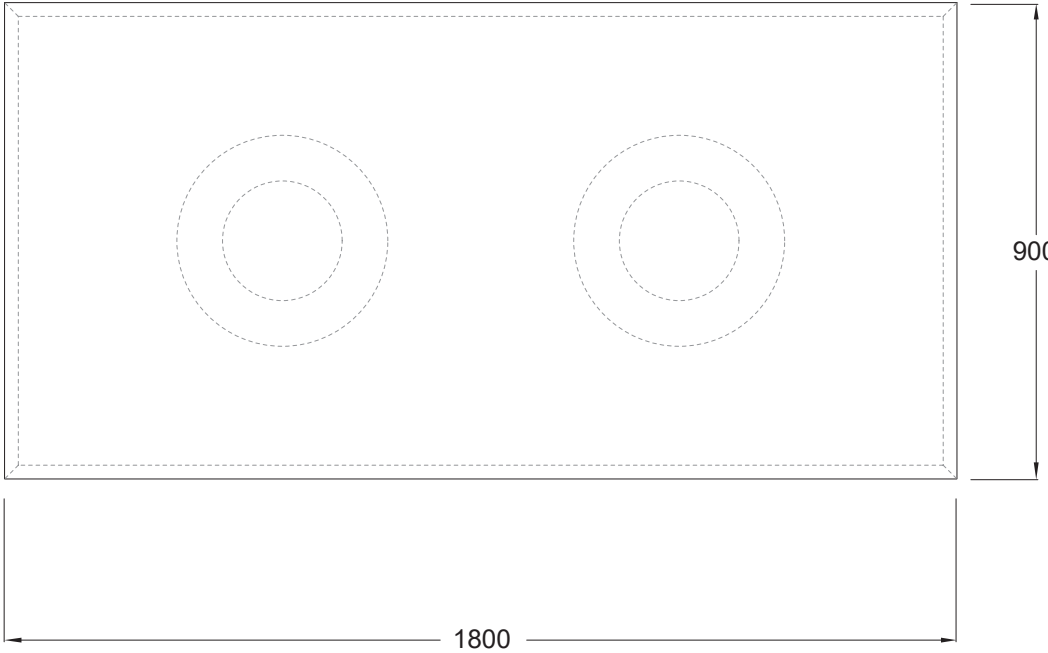

# LIQUEUR TABLE

LQ\_TB.90-DIA[SML]

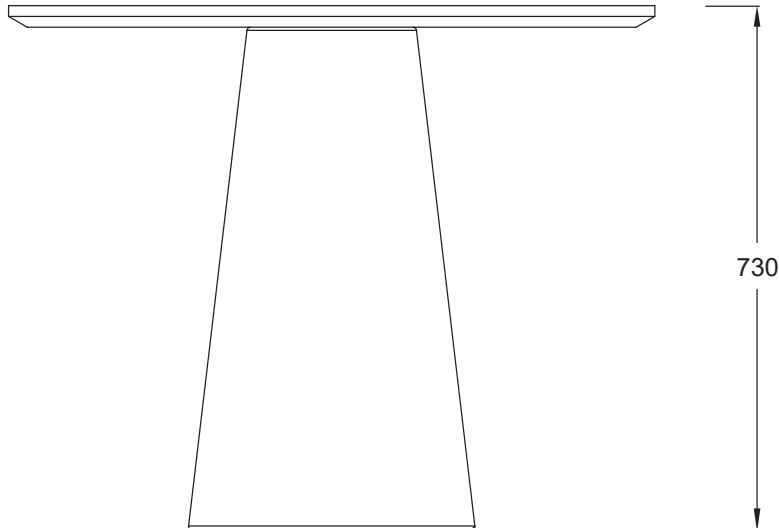
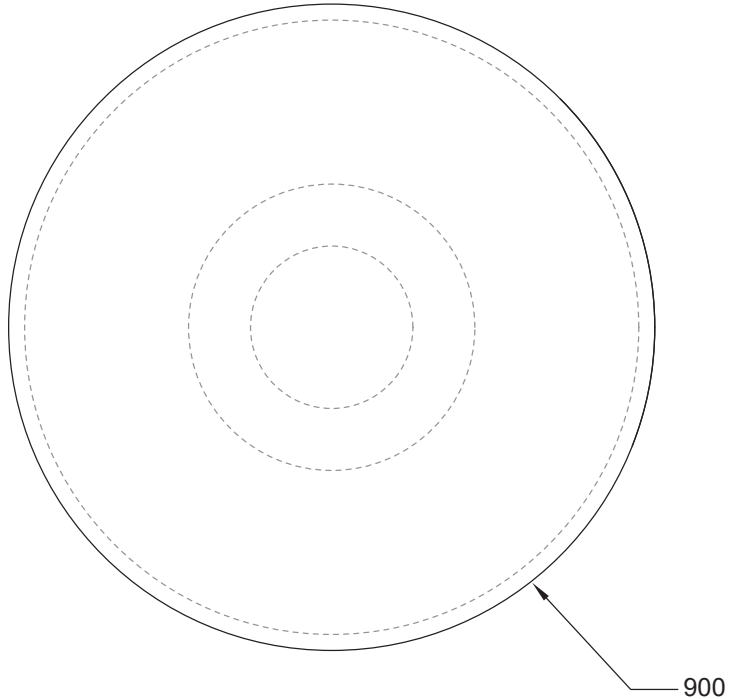

# LIQUEUR TABLE

LQ\_TB.80x80[SML]

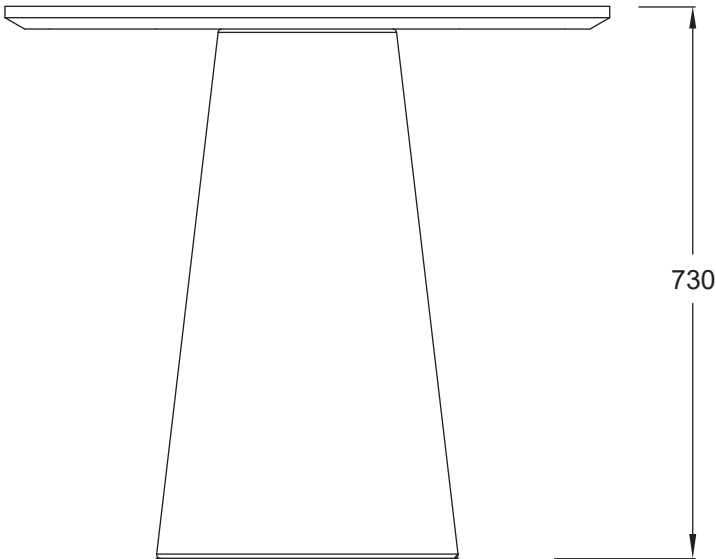
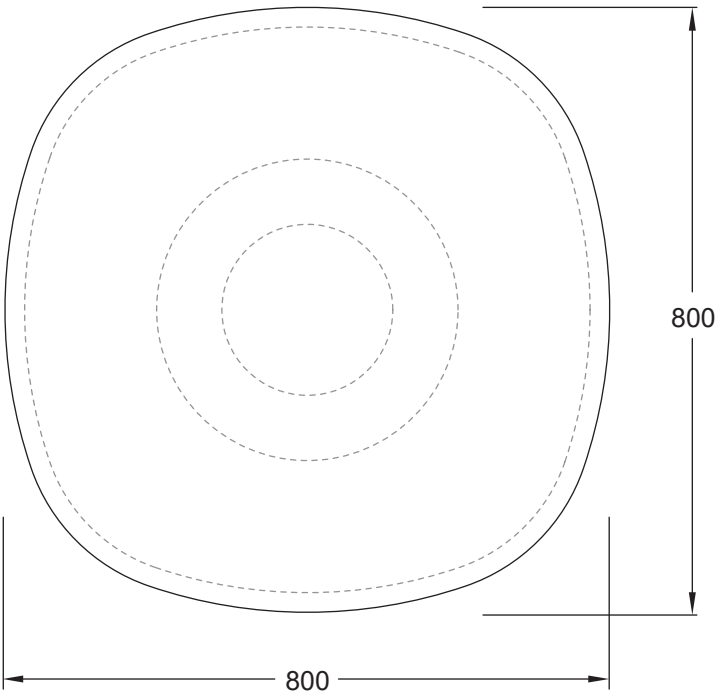

# LIQUEUR TABLE

LQ\_TB.180x90

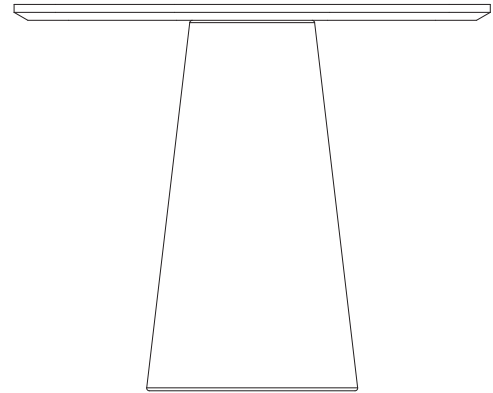
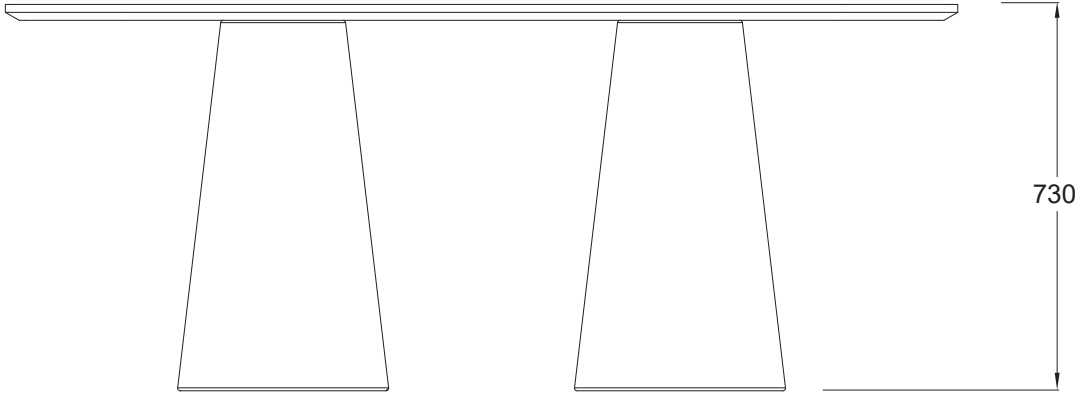
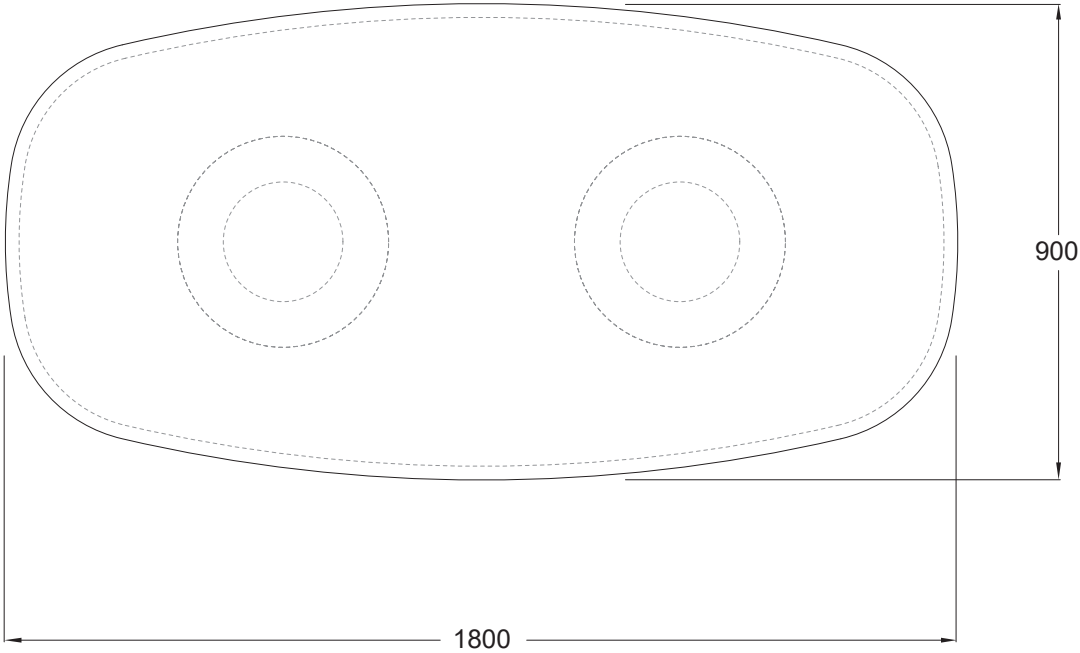

# LIQUEUR TABLE

LQ\_TB.210x90[RECT]

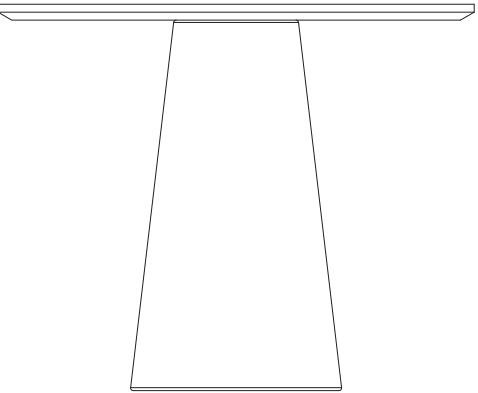
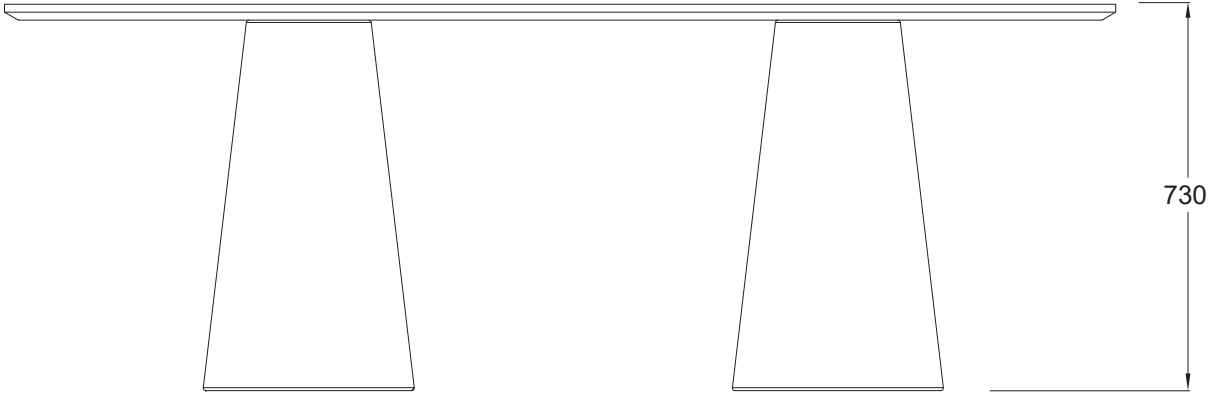
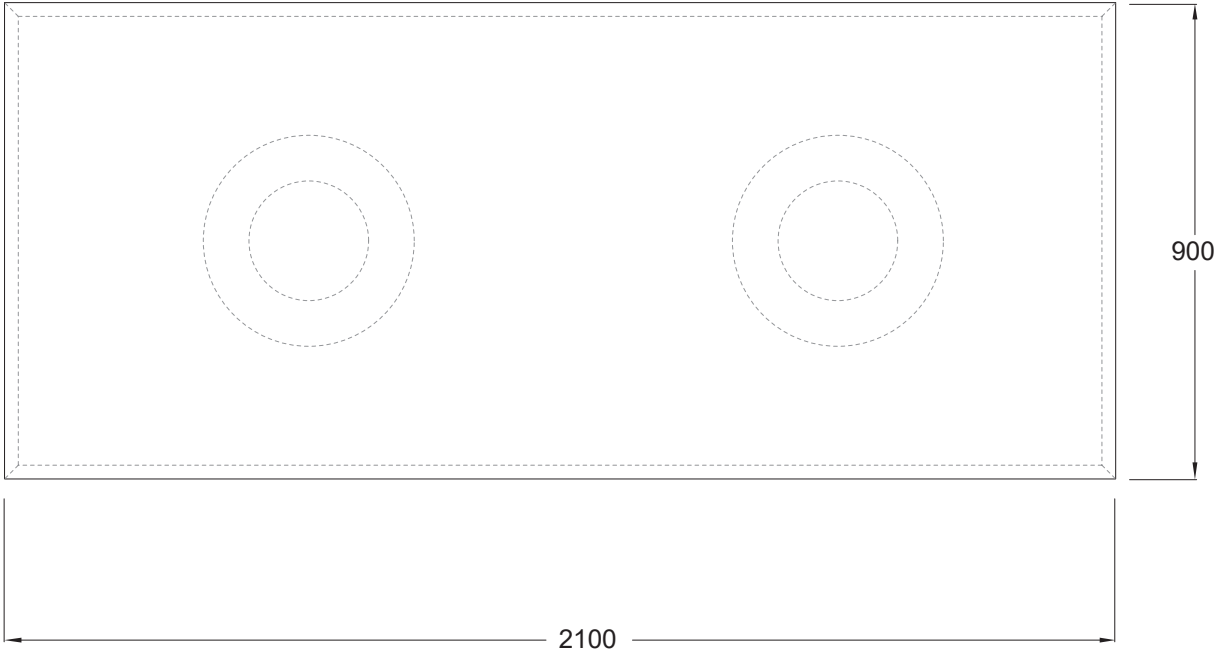

# LIQUEUR TABLE

LQ\_TB.105-DIA[SML]

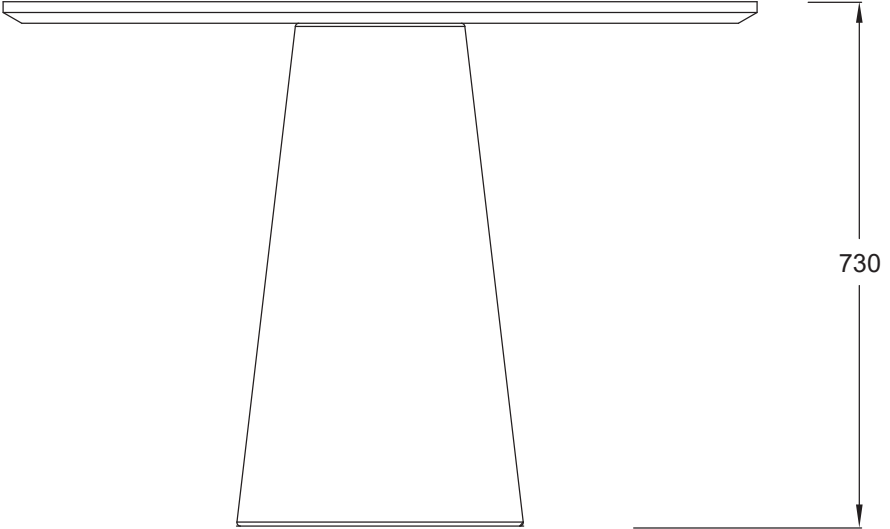
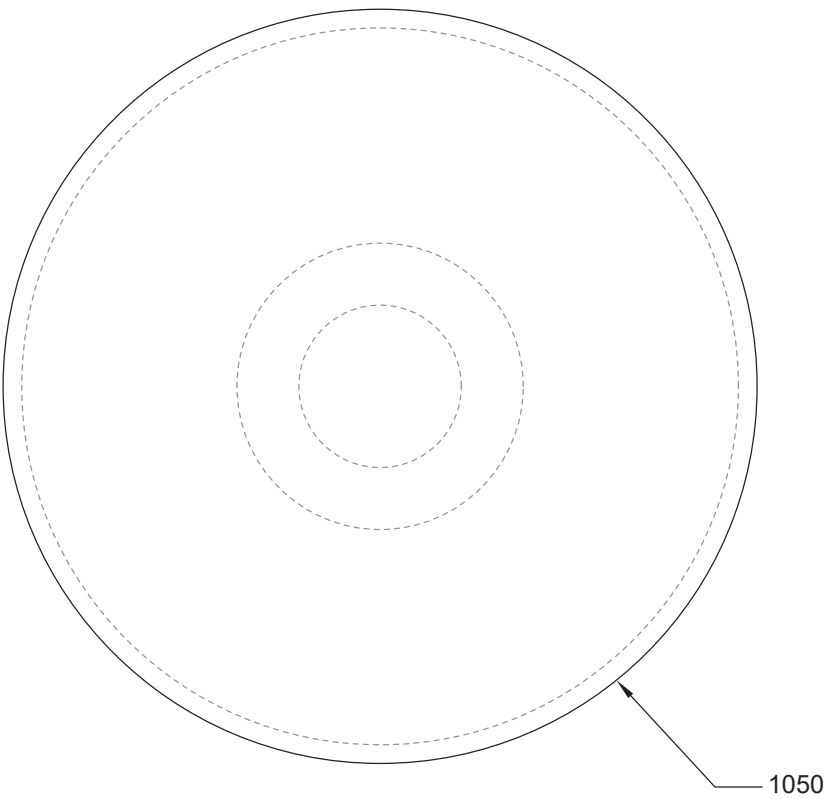

# LIQUEUR TABLE

LQ\_TB.105x105[SML]

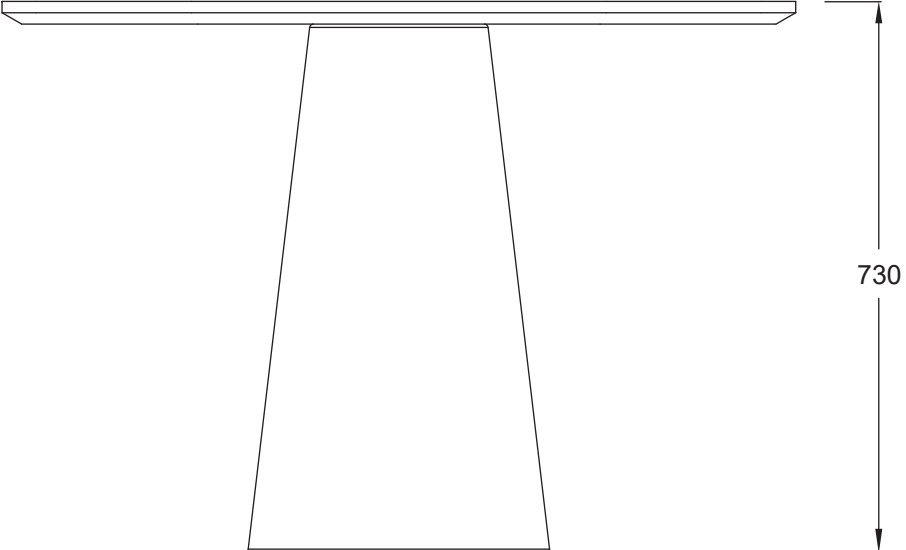
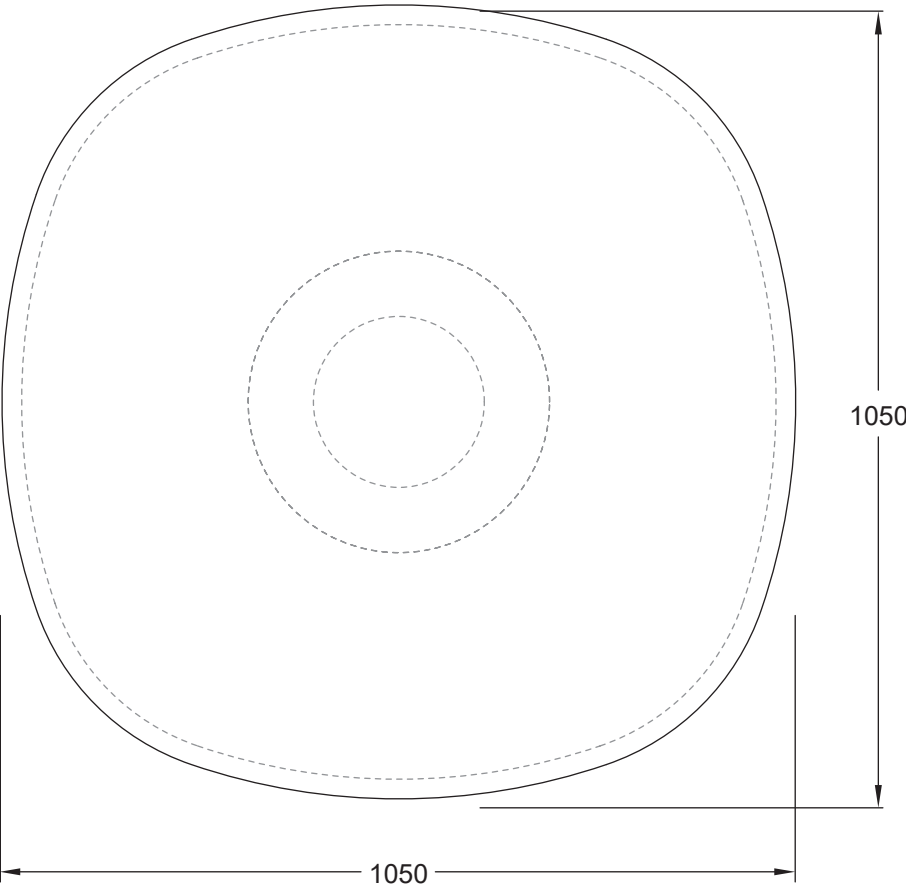

# LIQUEUR TABLE

LQ\_TB.210x90

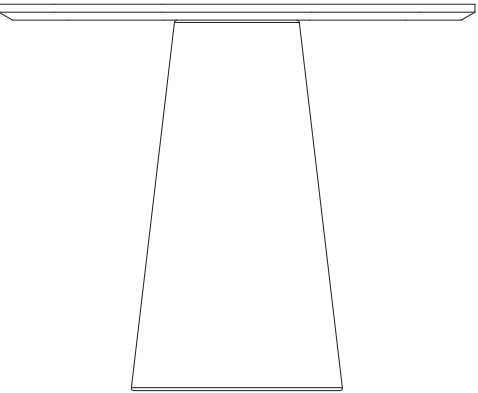
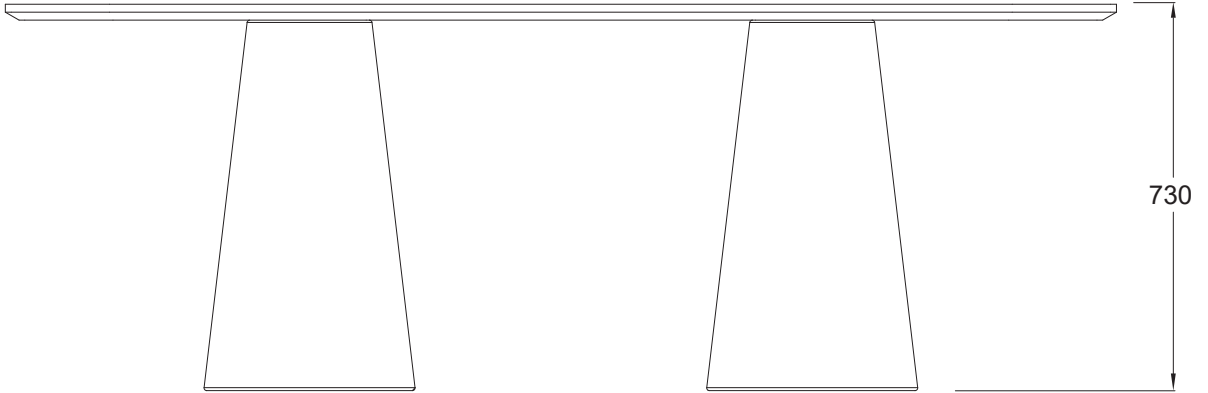
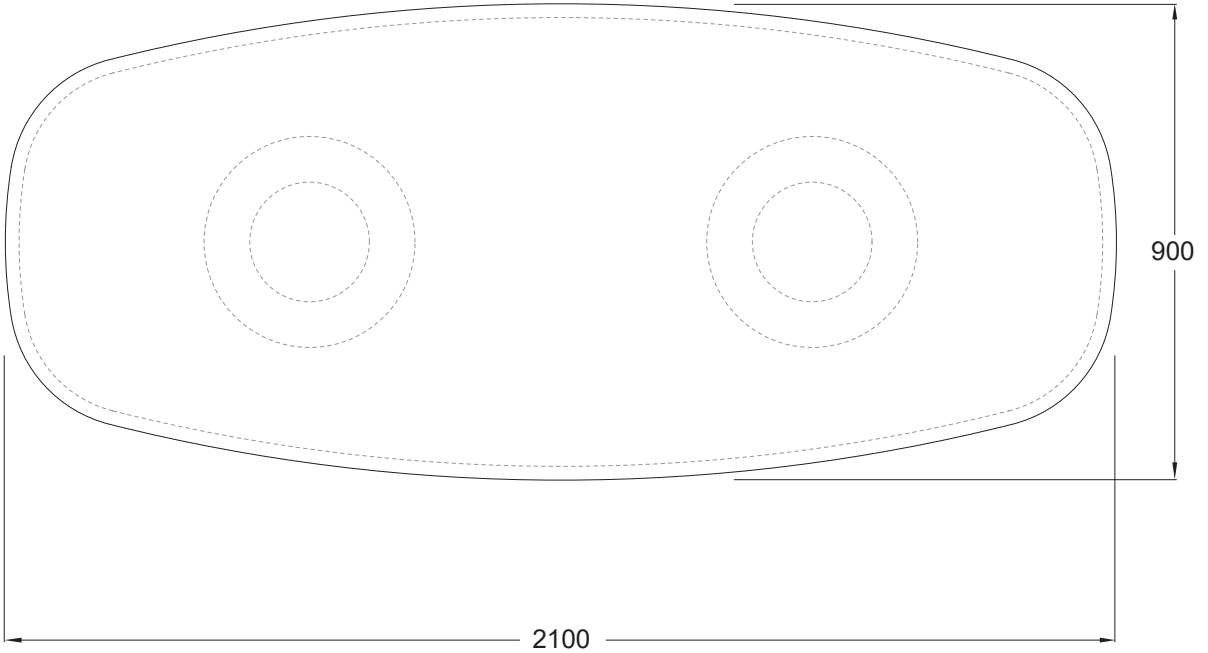



# LIQUEUR TABLE

LQ\_TB.240x90[RECT]

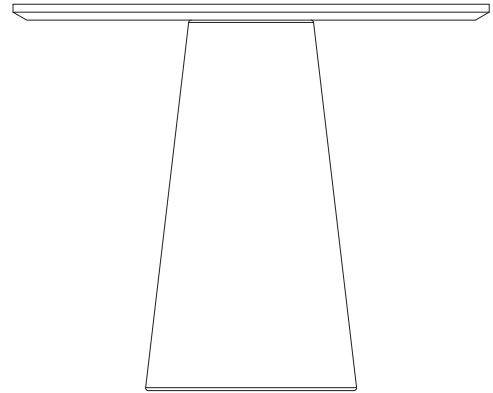
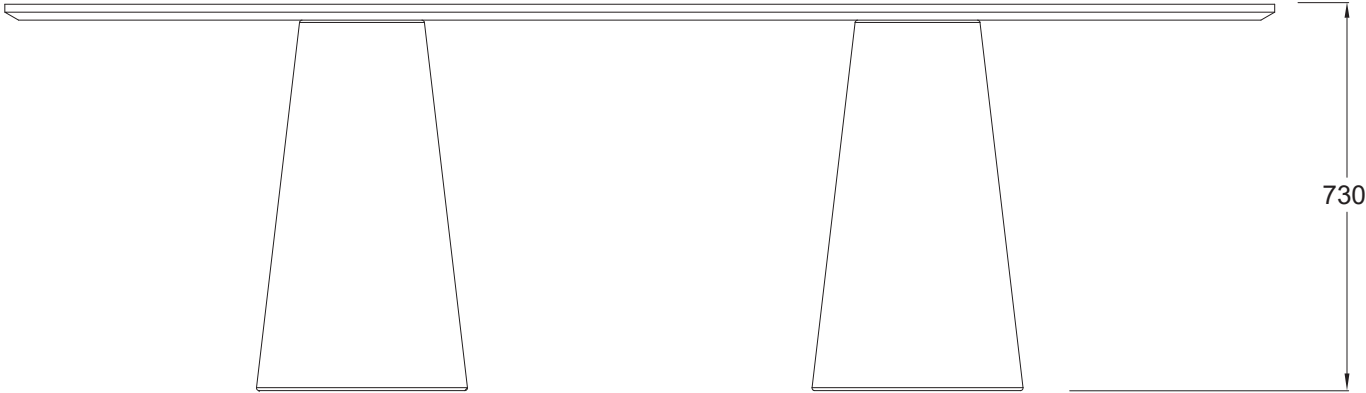
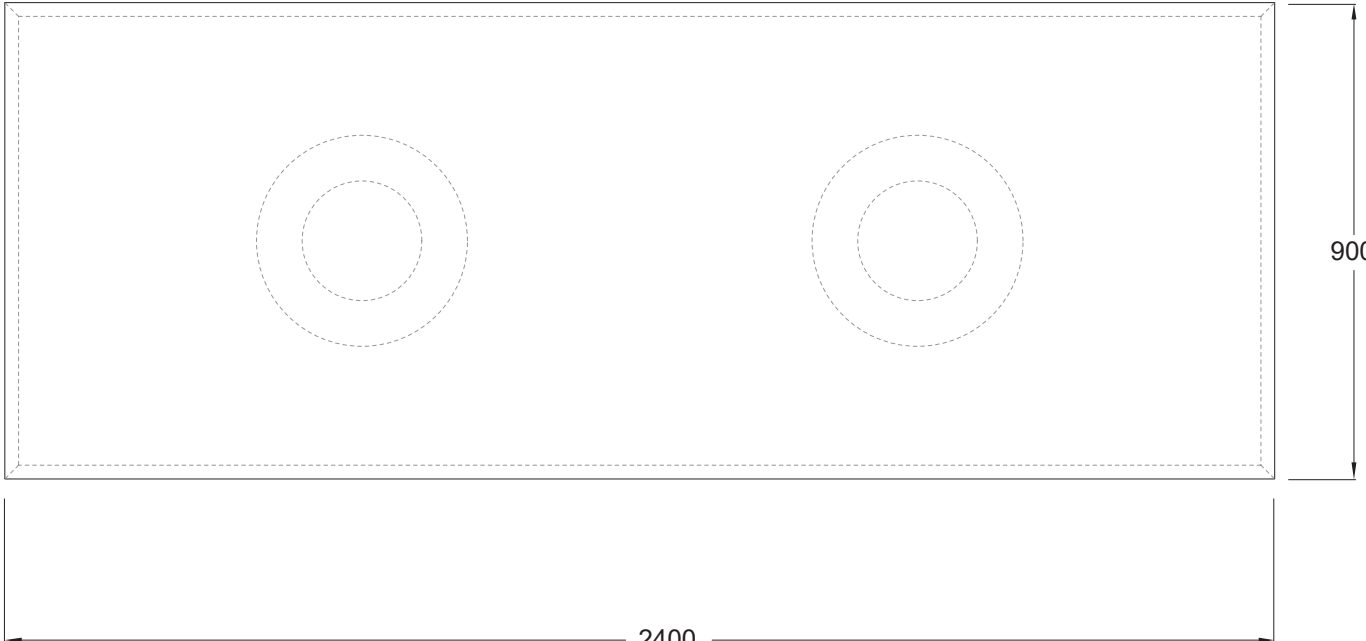

# LIQUEUR TABLE

LQ\_TB.240x90

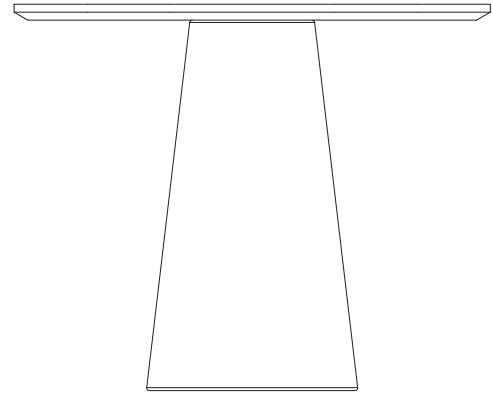
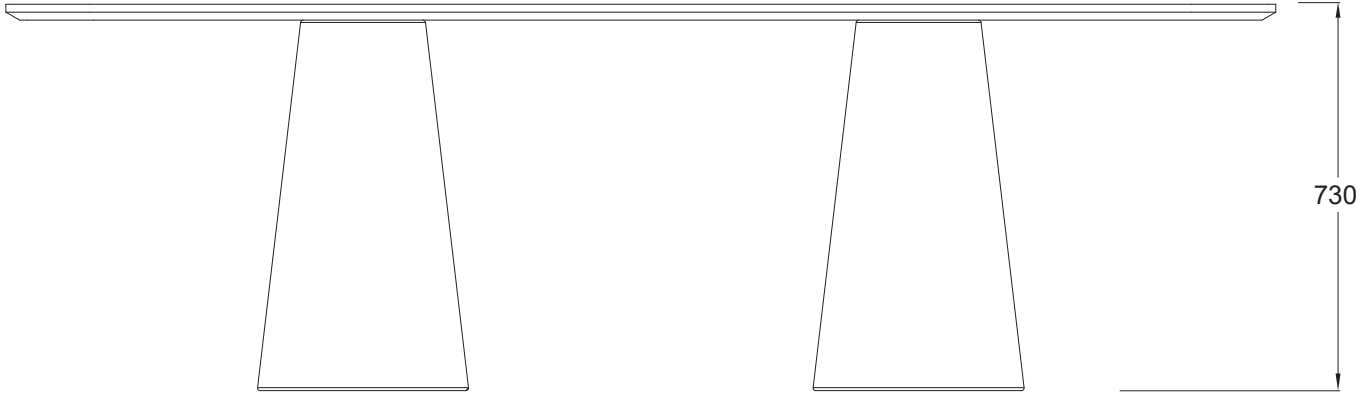
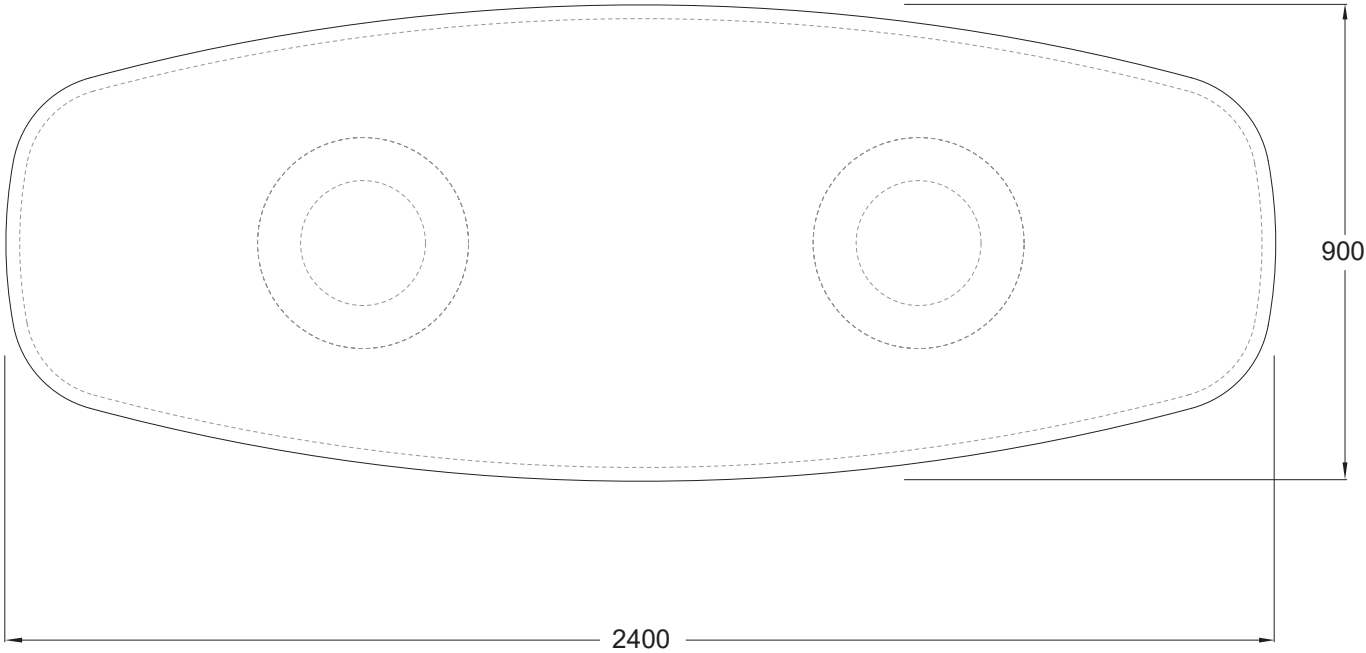

# LIQUEUR TABLE

LQ\_TB.270x90[RECT]

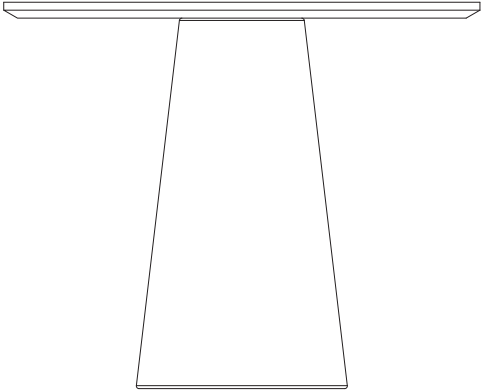
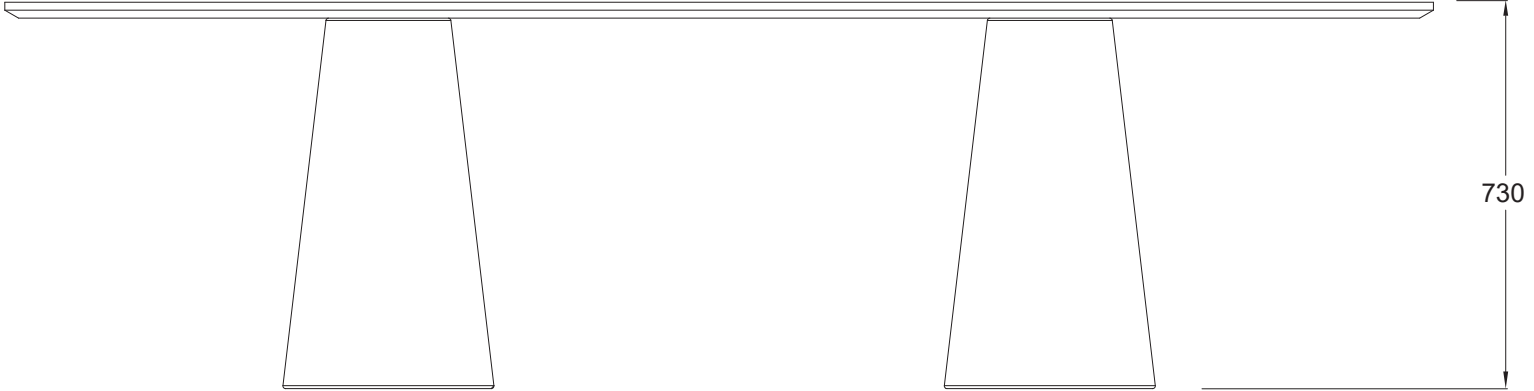
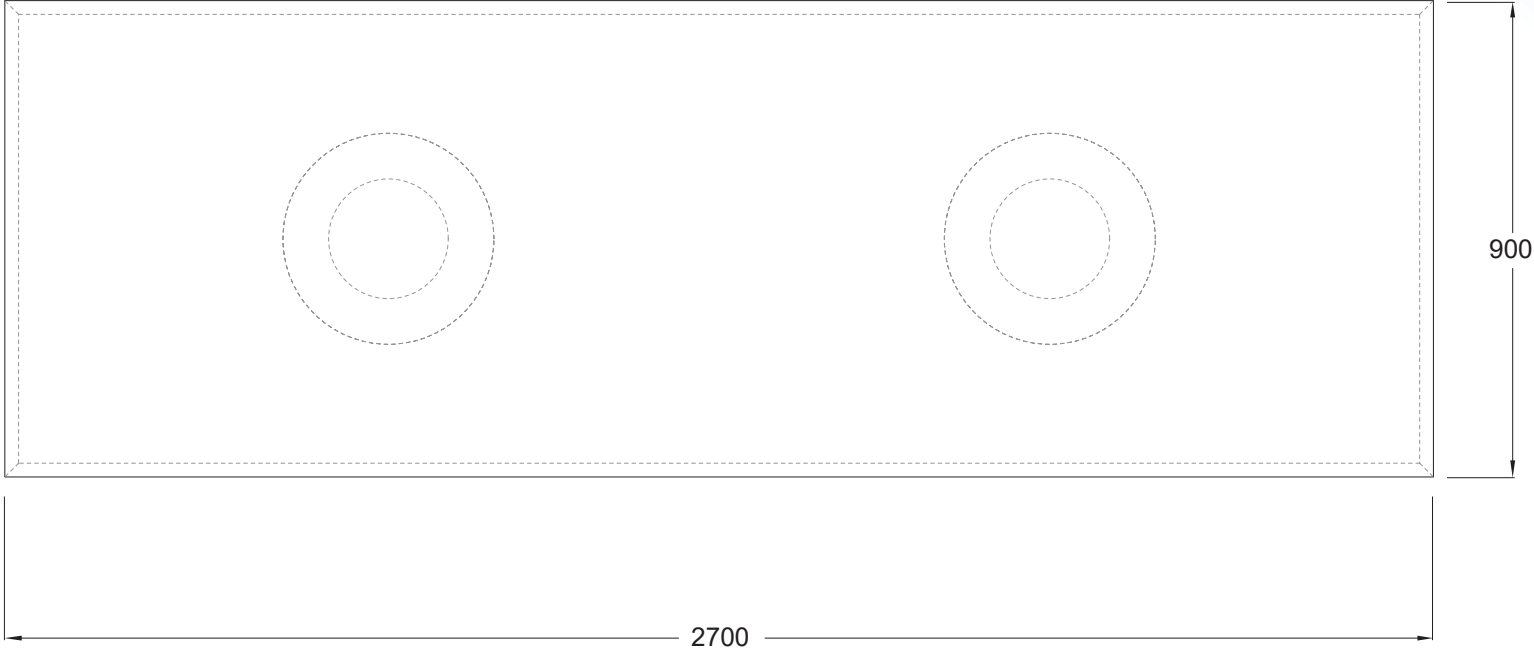

# LIQUEUR TABLE

LQ\_TB.270x90

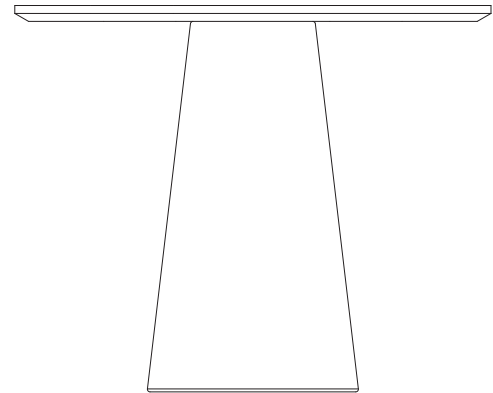
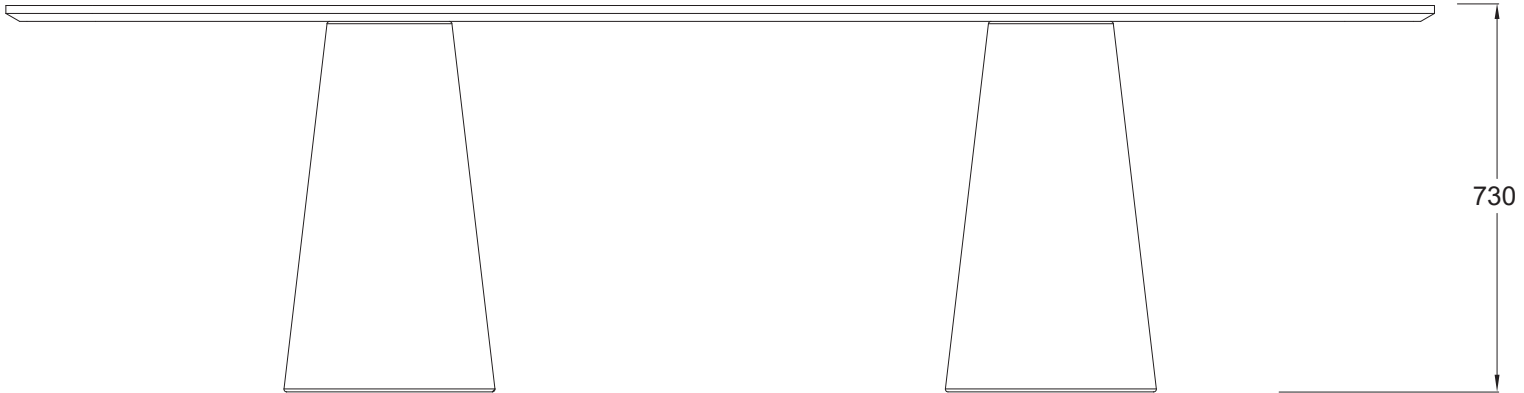
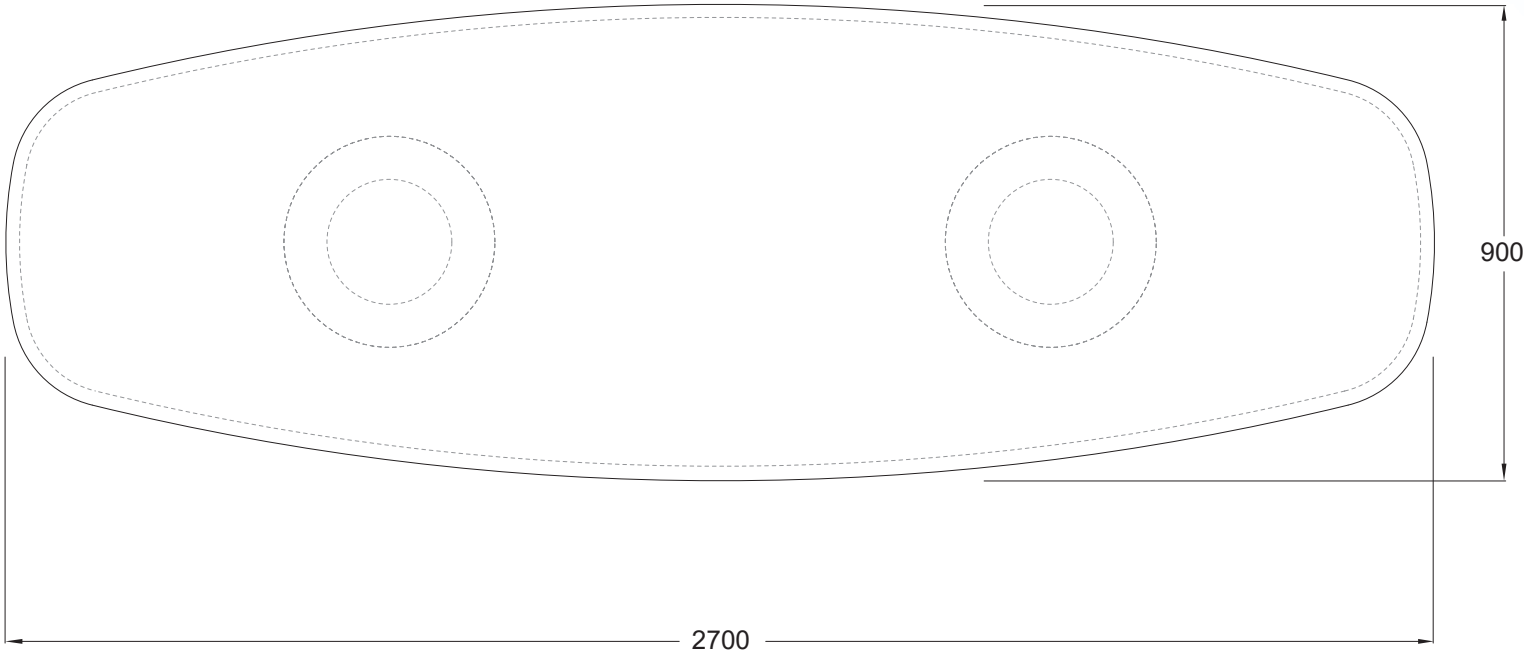

# LIQUEUR TABLE

LQ\_TB.90-DIA

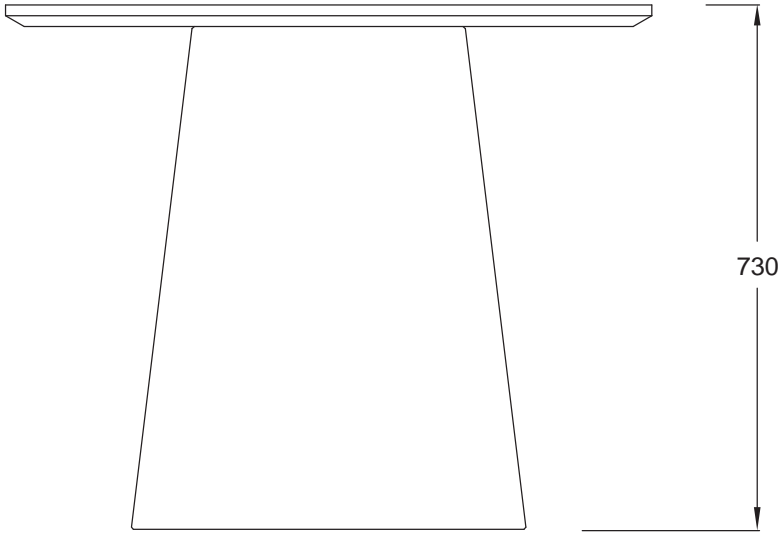
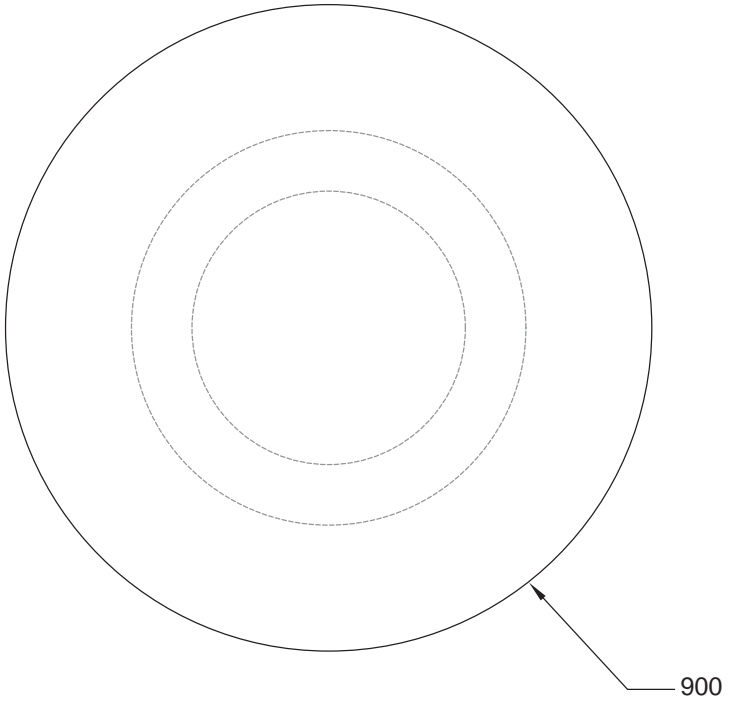

# LIQUEUR TABLE

LQ\_TB.105-DIA

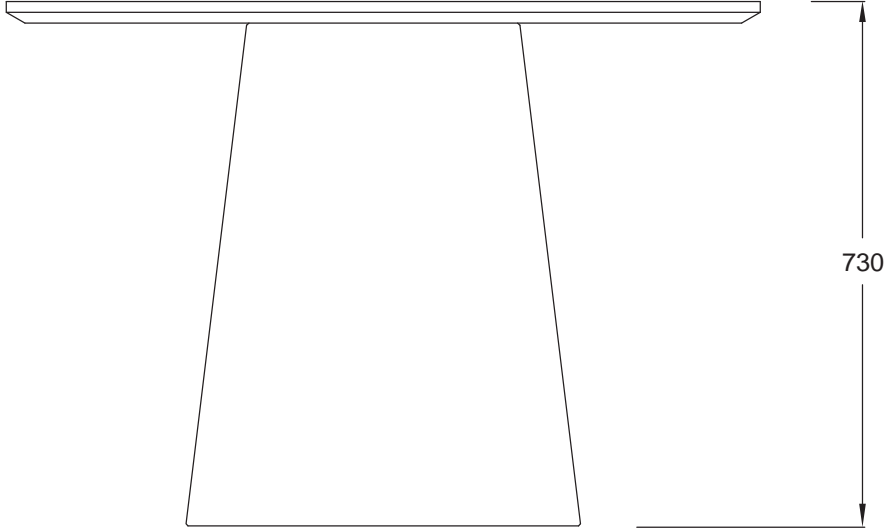
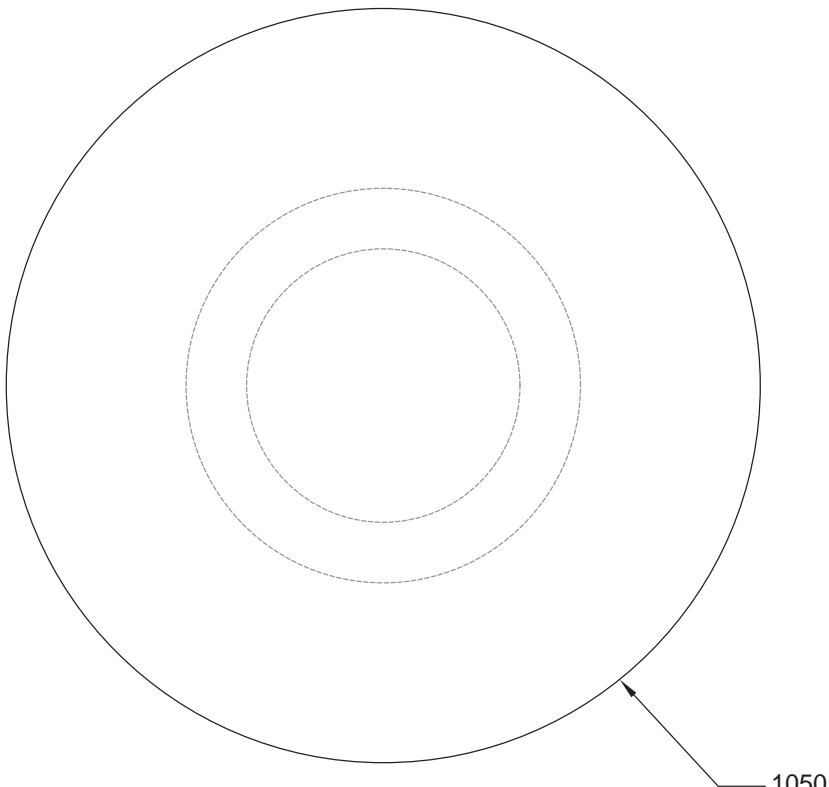

# LIQUEUR TABLE

LQ\_TB.120-DIA

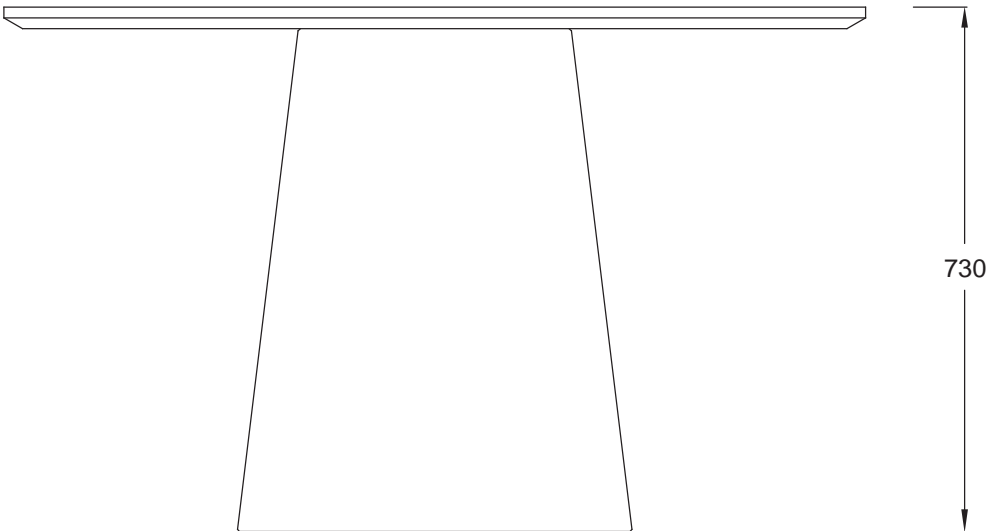
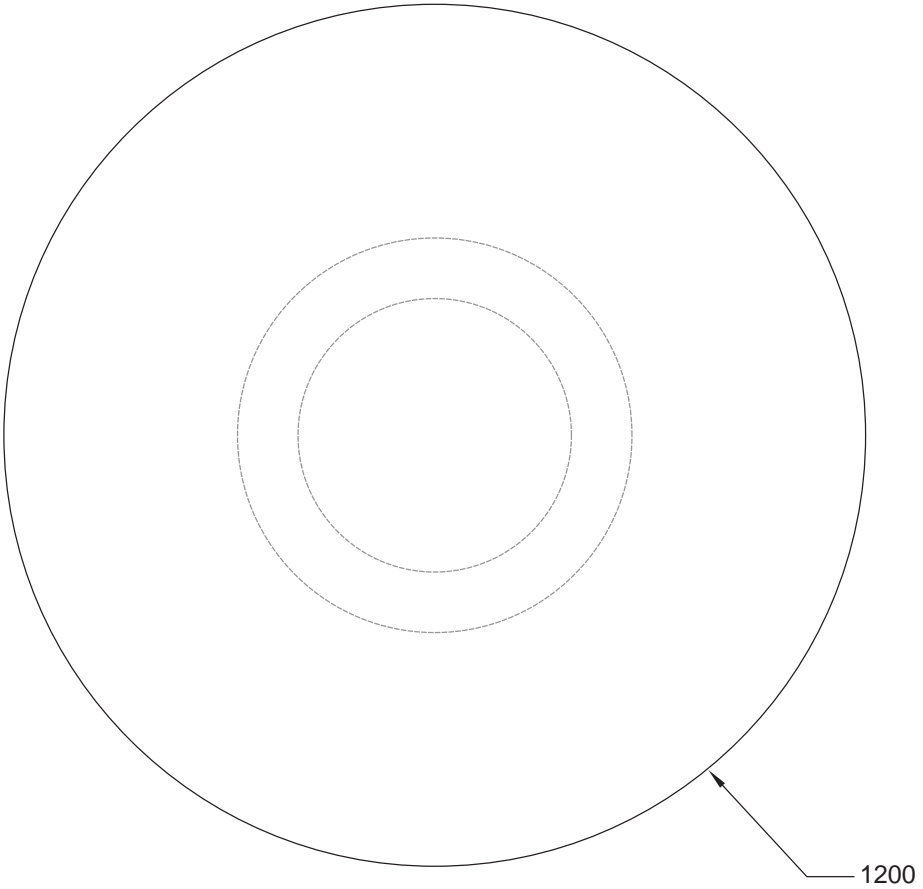

# LIQUEUR TABLE

LQ\_TB.135-DIA

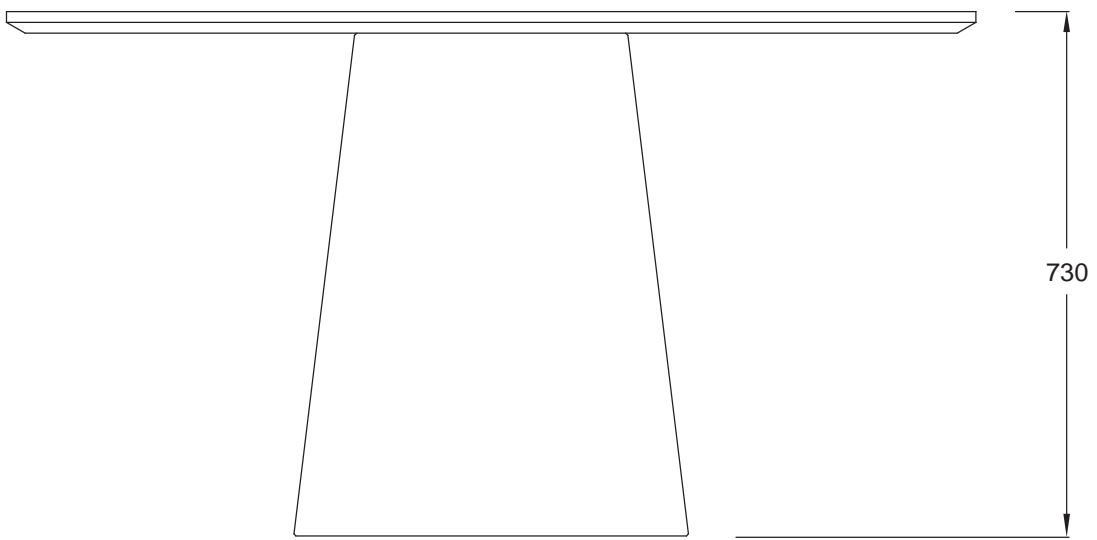
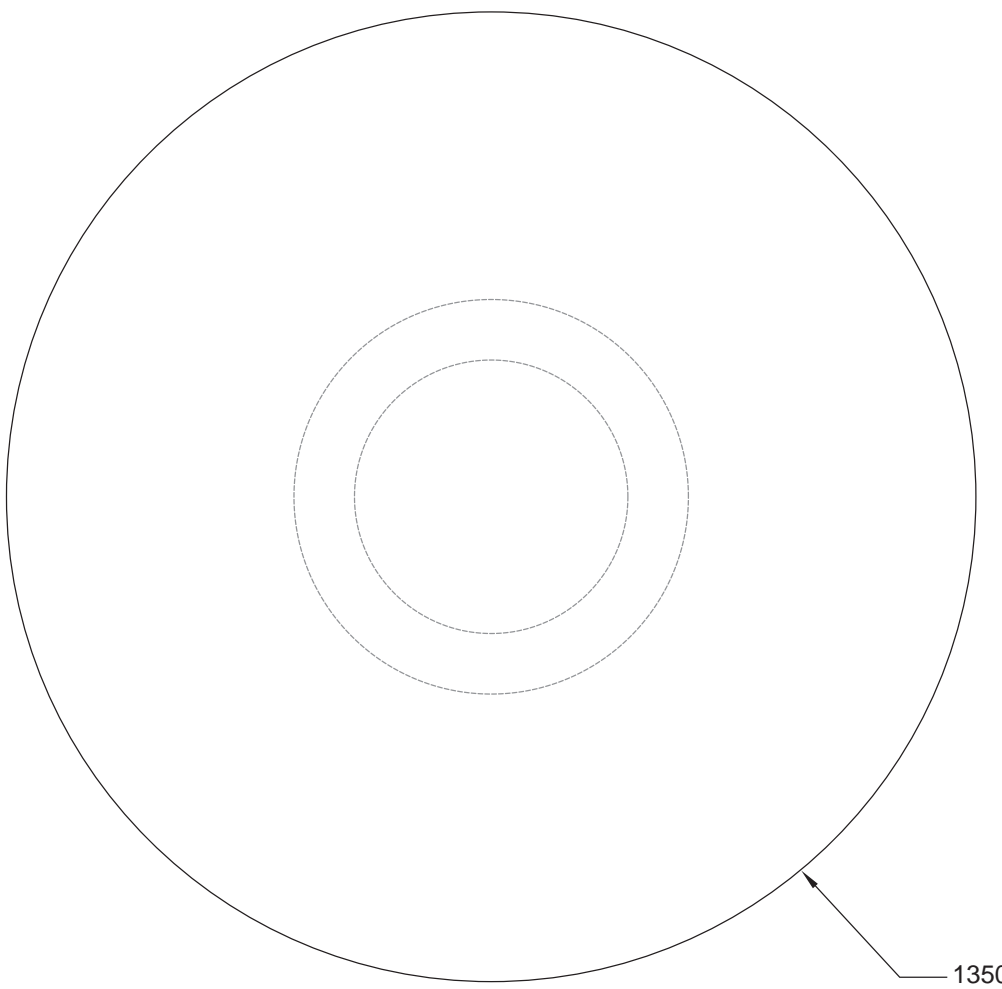



# LIQUEUR TABLE

LQ\_TB.150-DIA

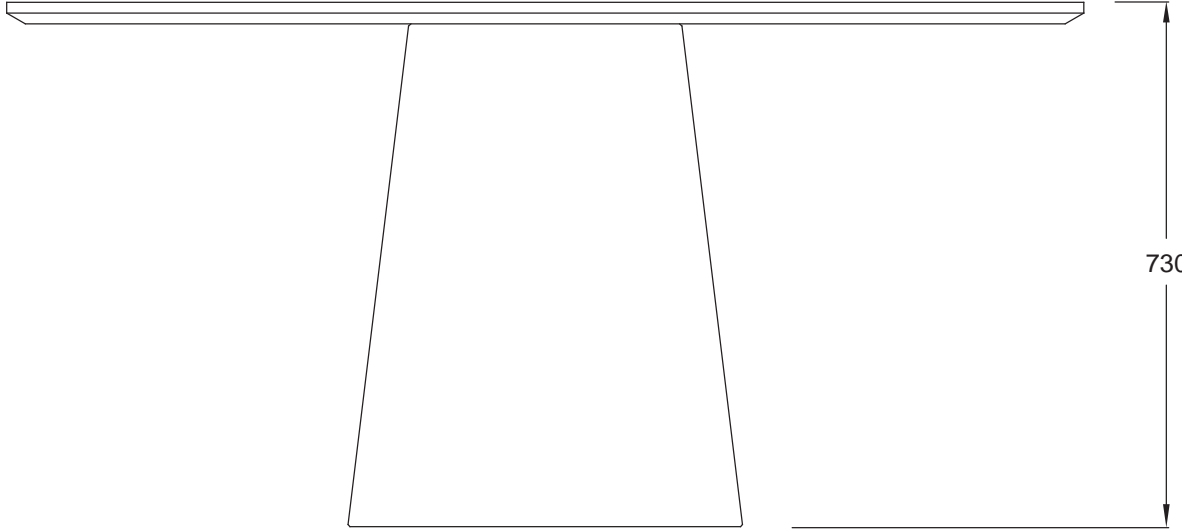
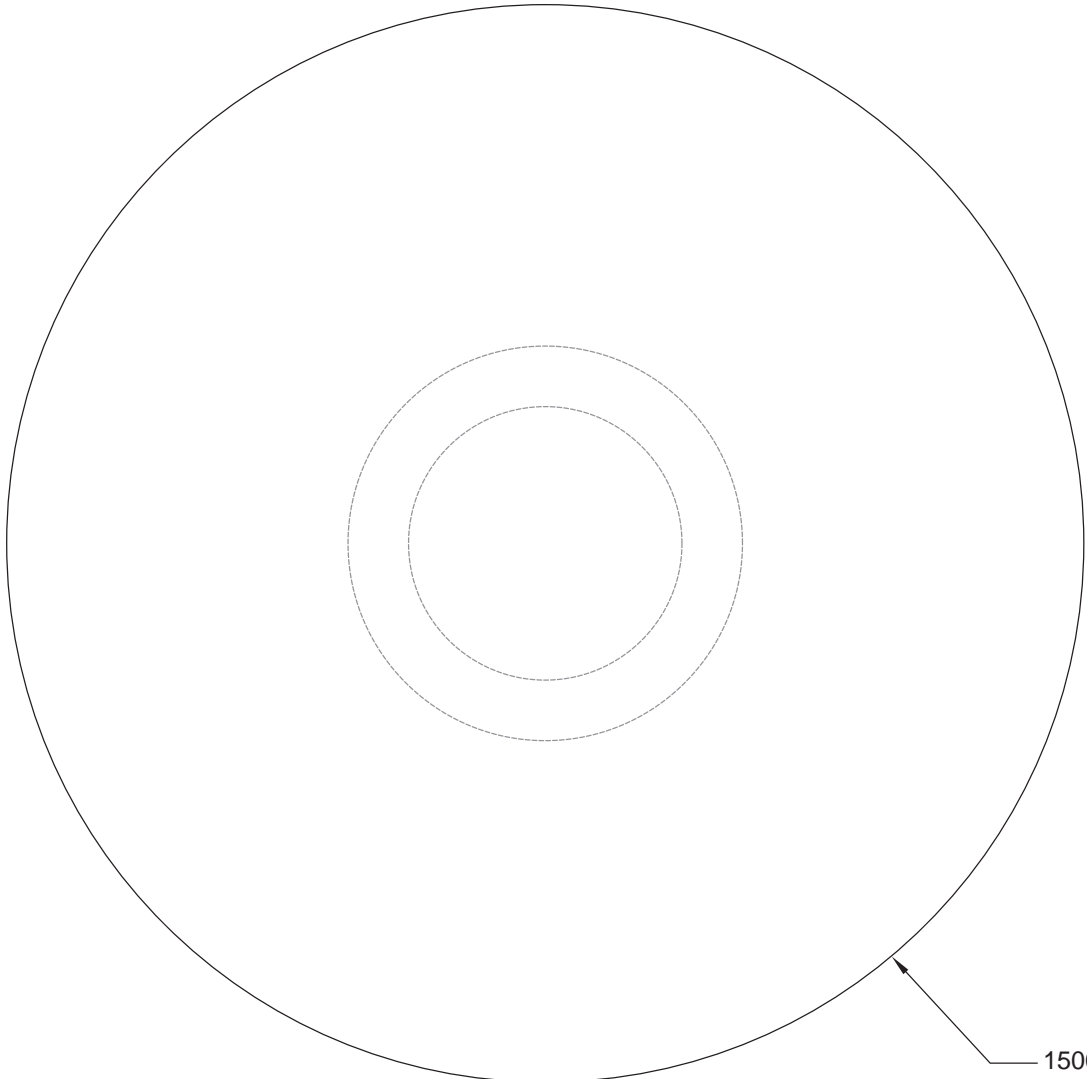

# LIQUEUR TABLE

LQ\_TB.180-DIA

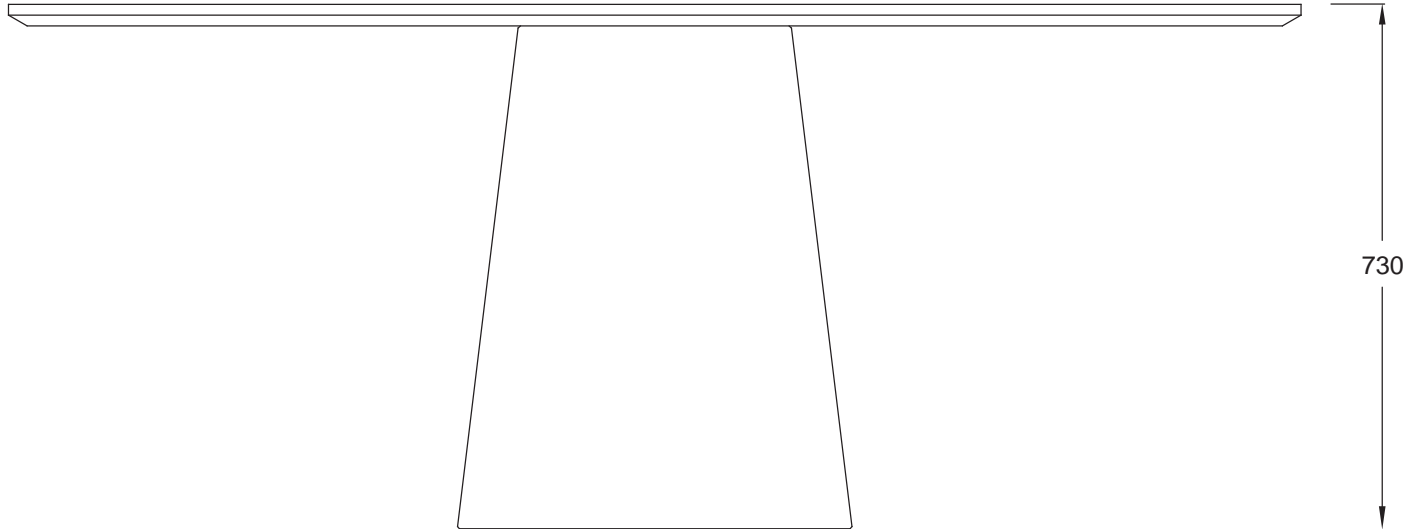
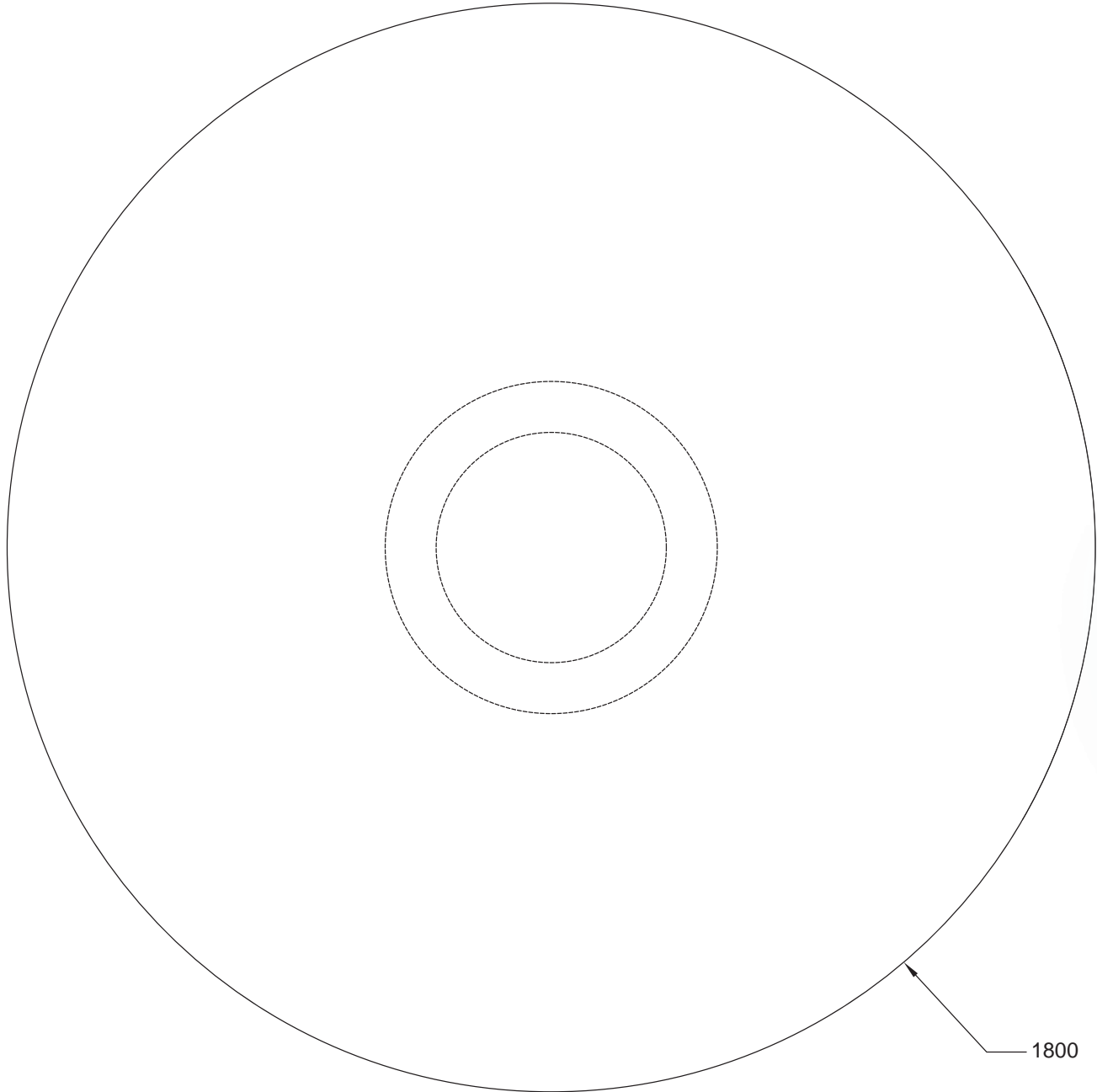

# LIQUEUR TABLE

LQ\_TB.80X80

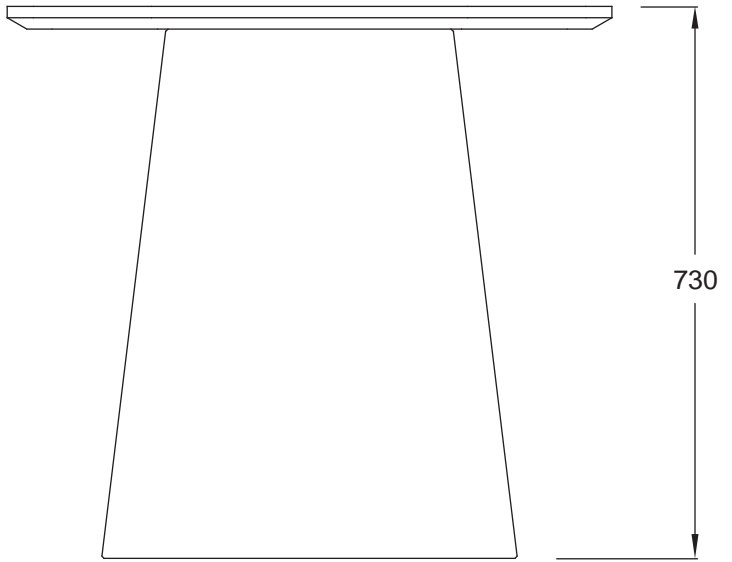
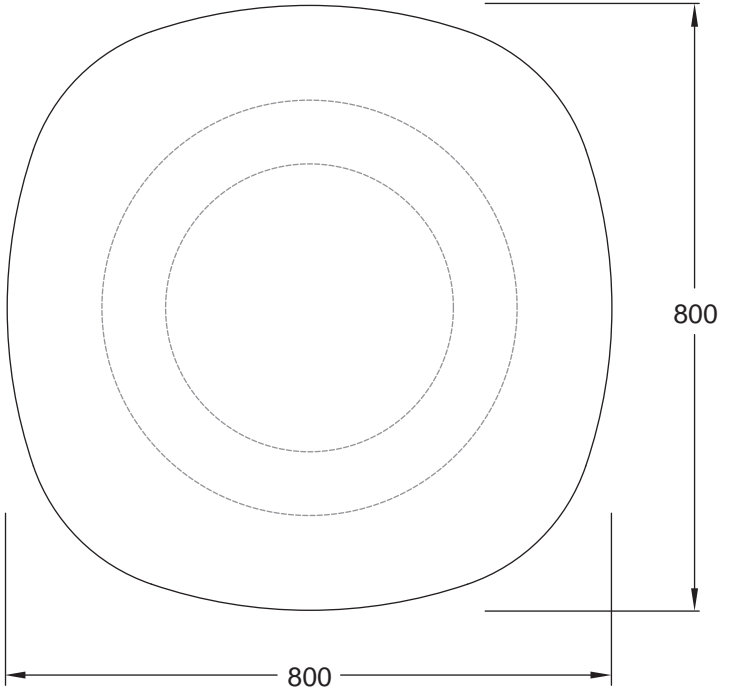

# LIQUEUR TABLE

LQ\_TB.115X115

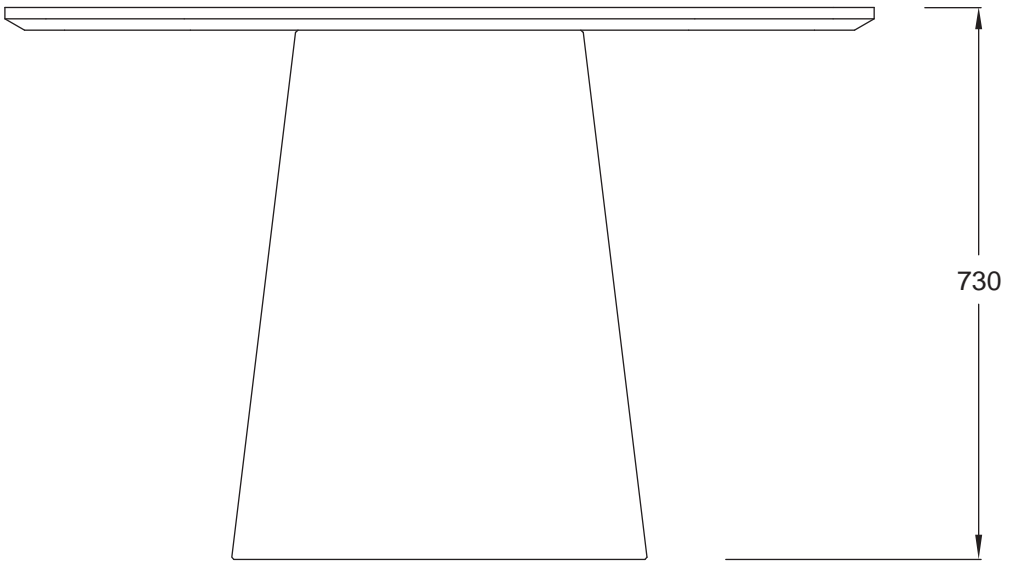
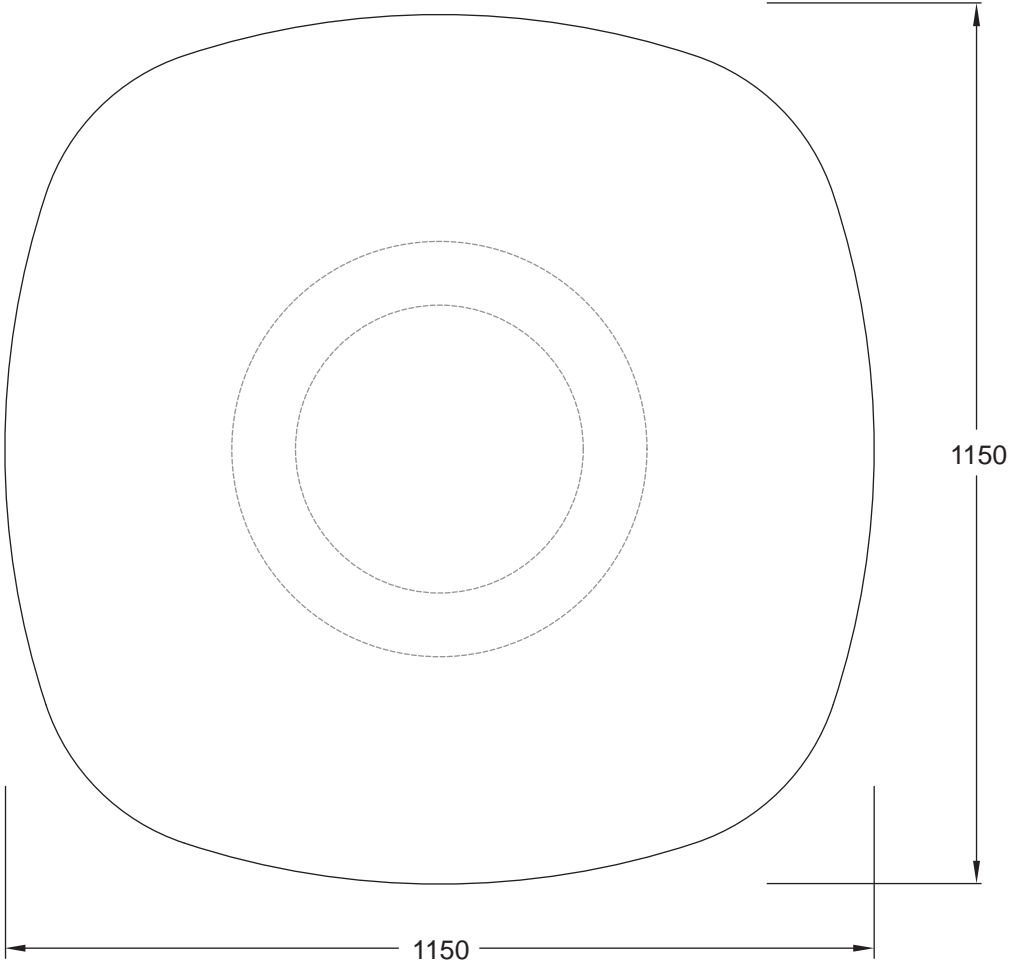

# LIQUEUR TABLE

LQ\_TB.150X150

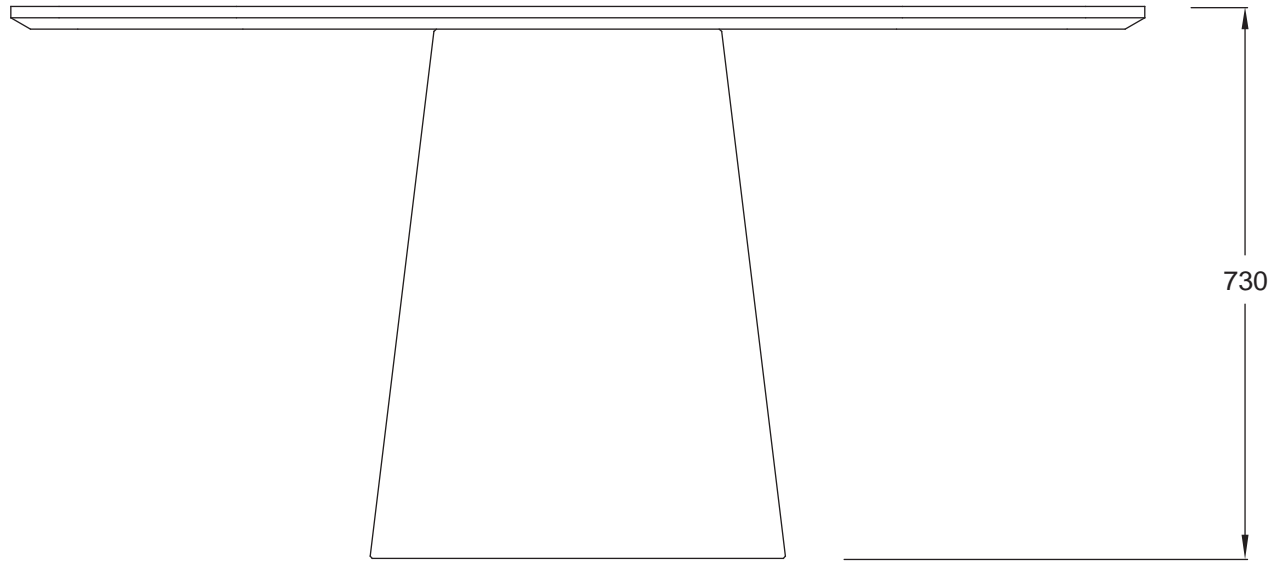
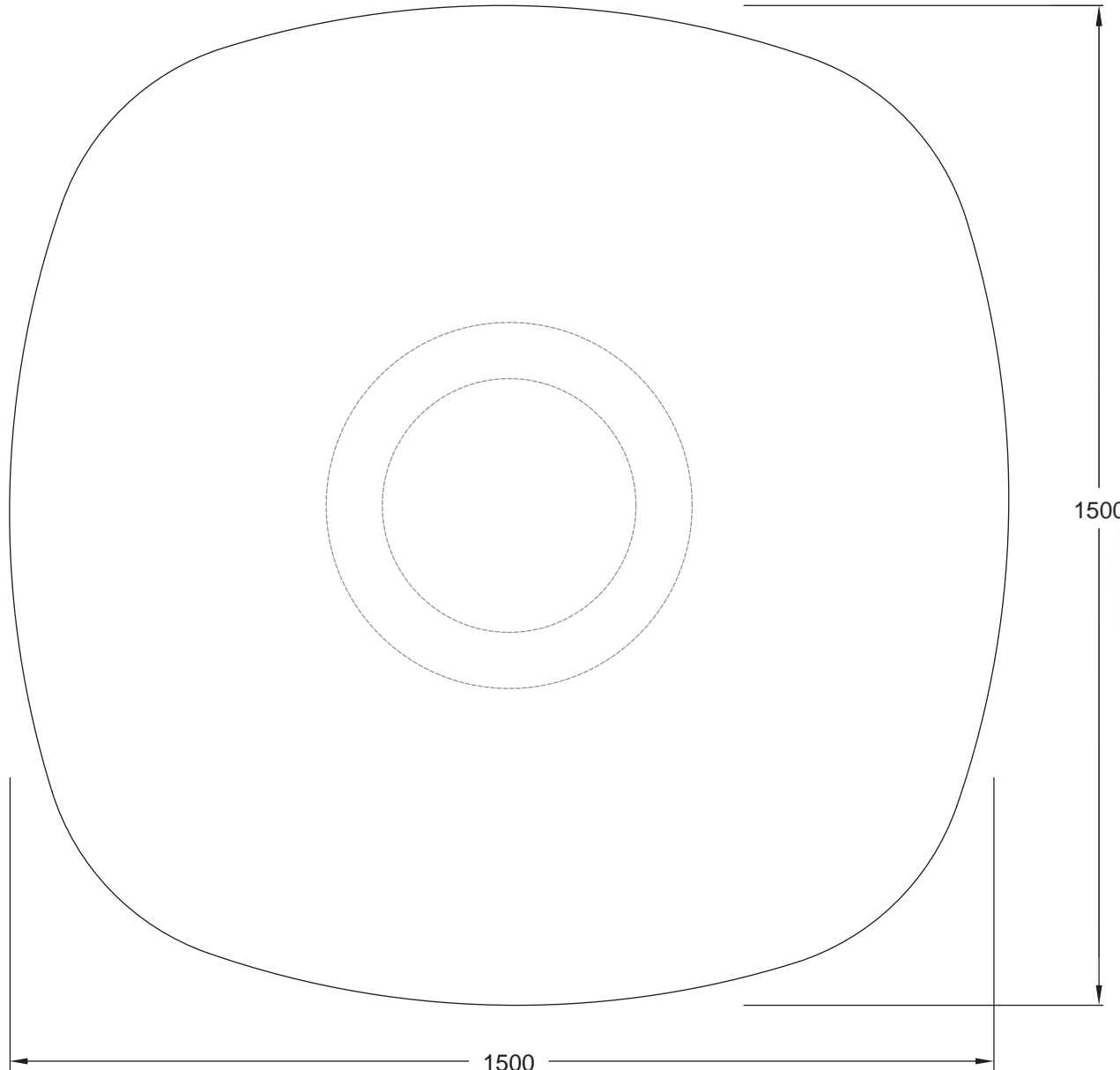

# LIQUEUR TABLE

LQ\_TB.150x120

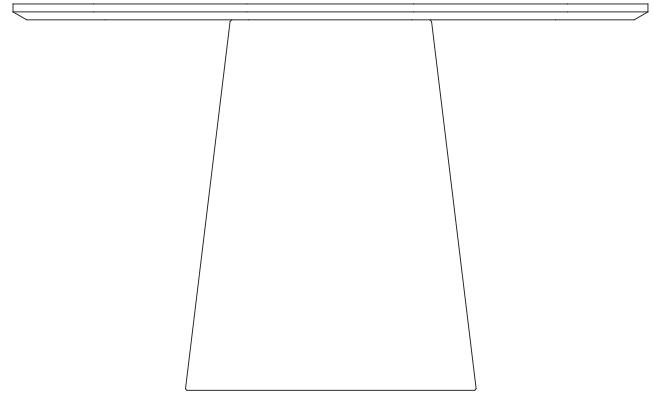
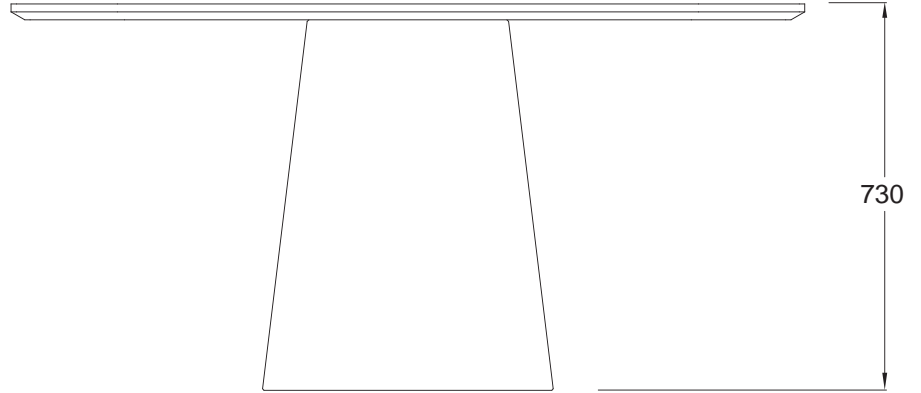
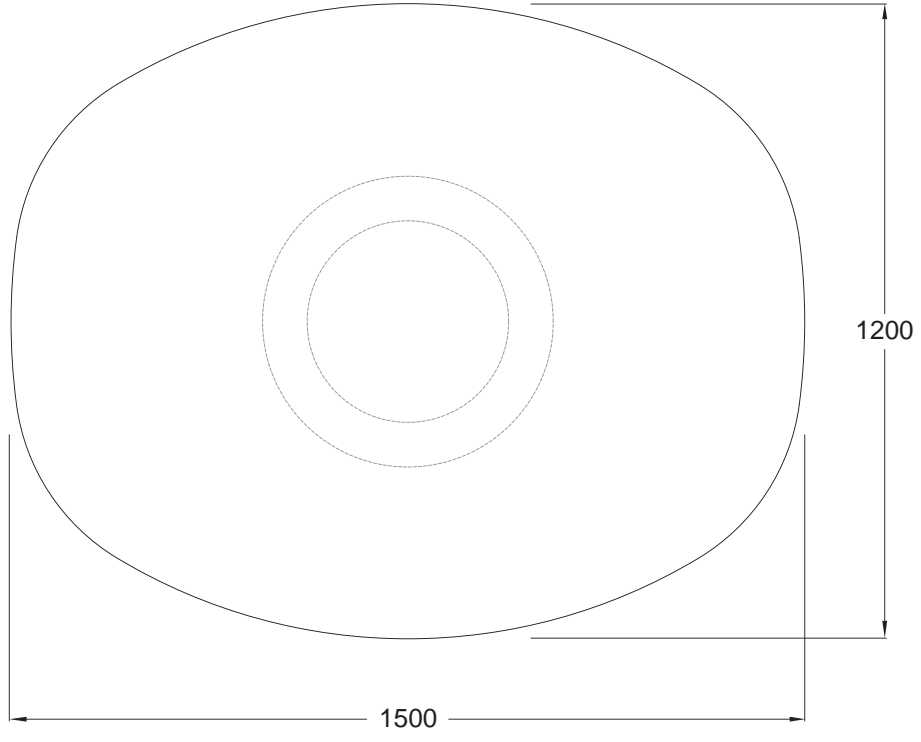

# LIQUEUR TABLE

LQ\_TB.180x120

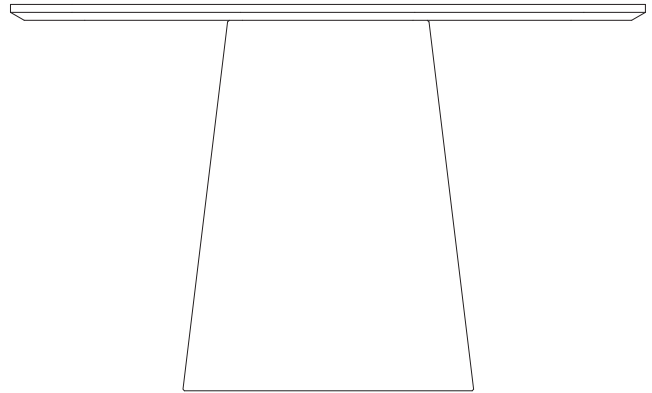
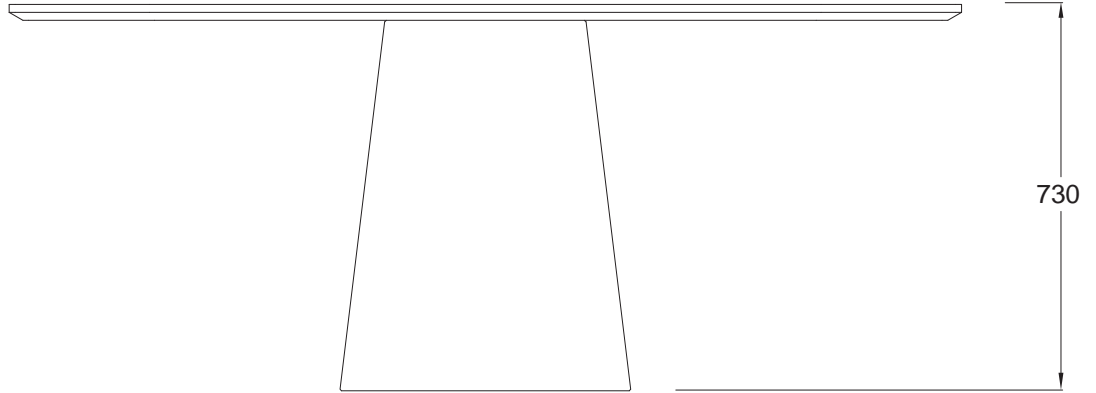
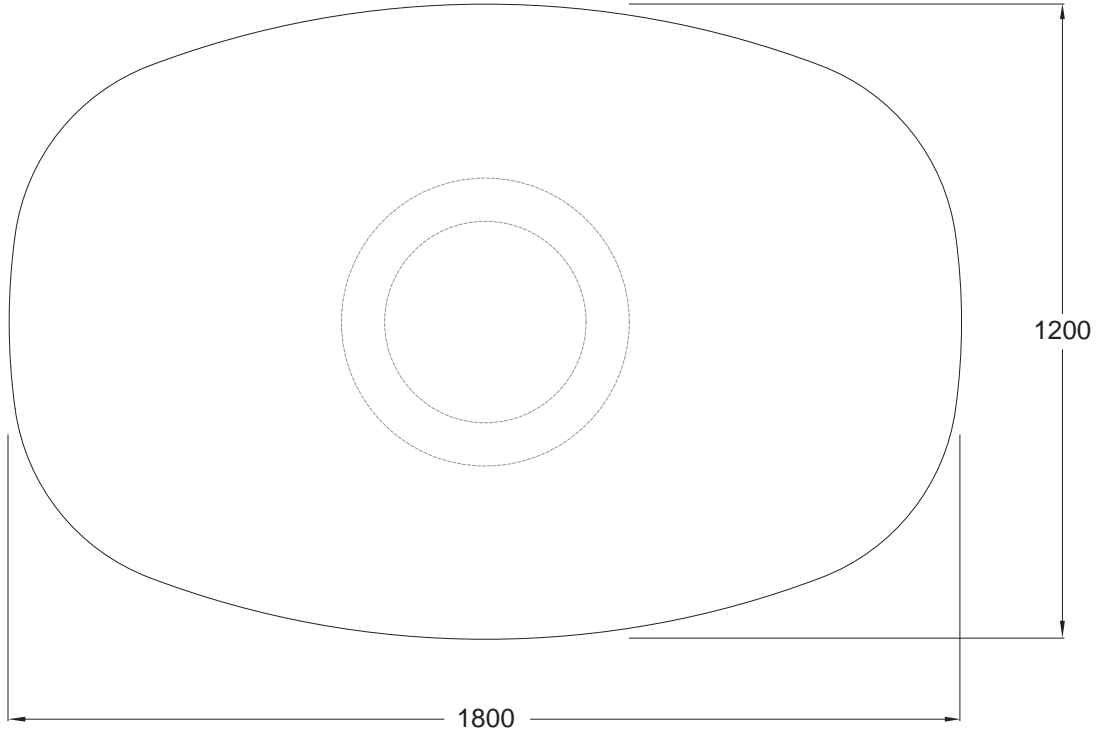

# LIQUEUR TABLE

LQ\_TB.210x120

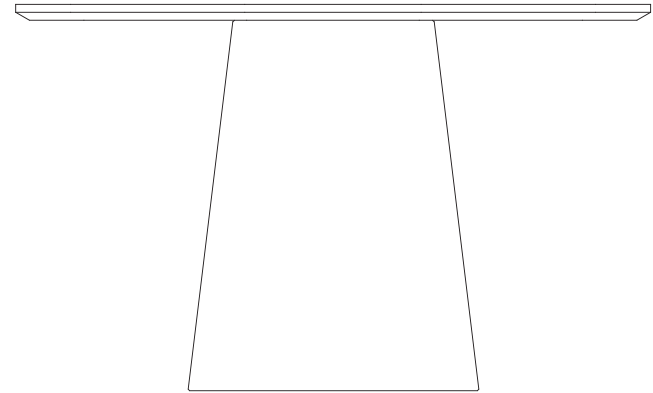
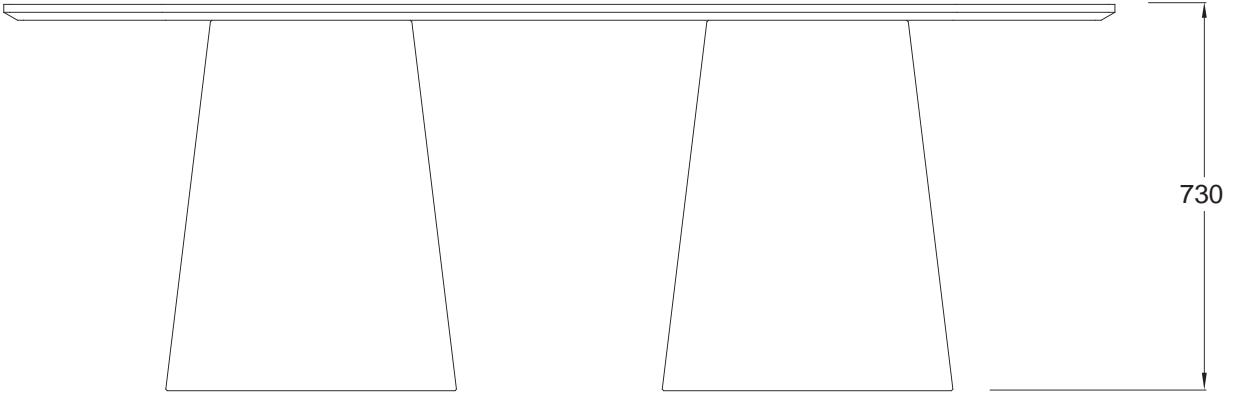
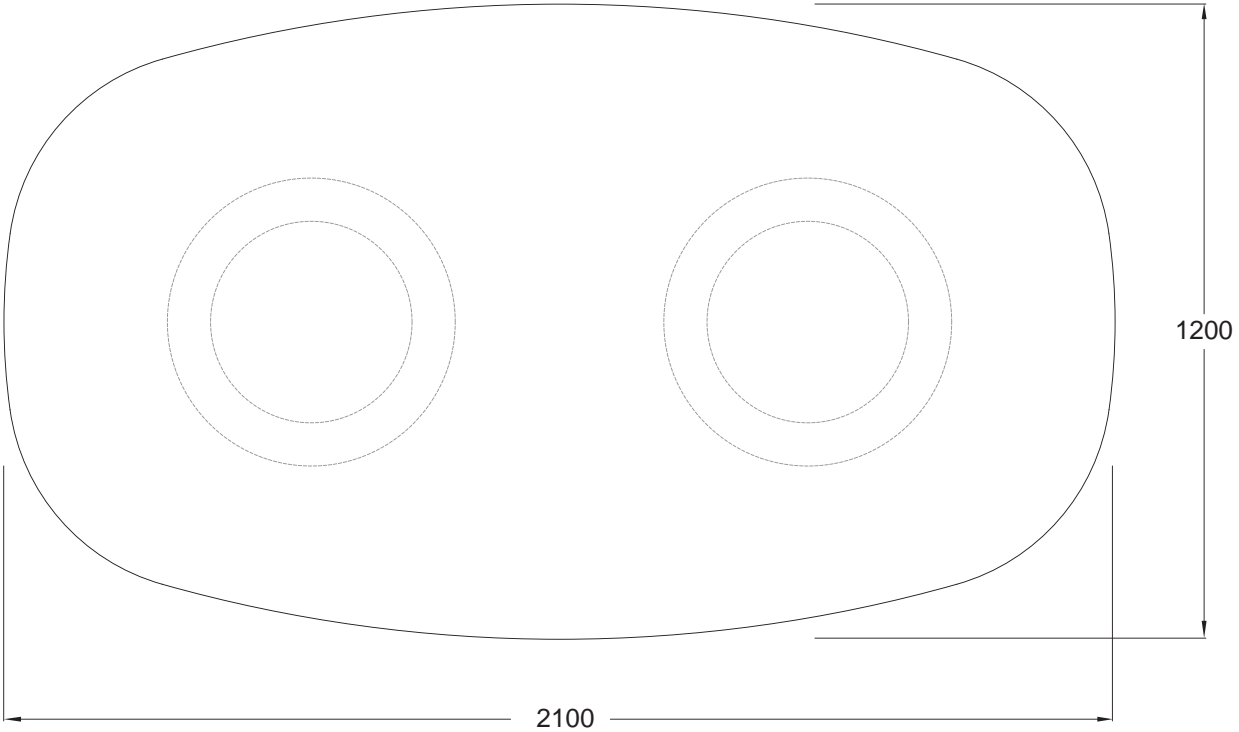



# LIQUEUR TABLE

LQ\_TB.240x120

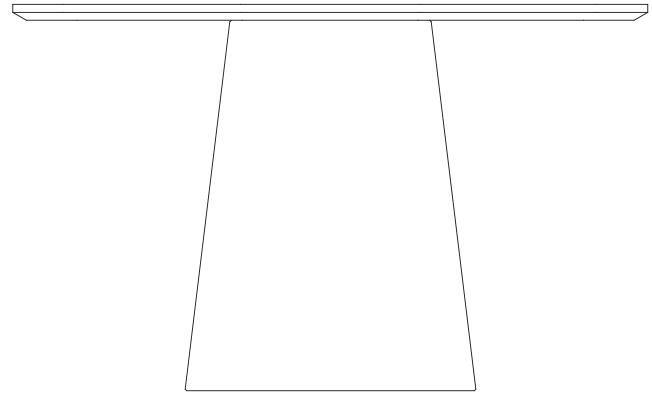
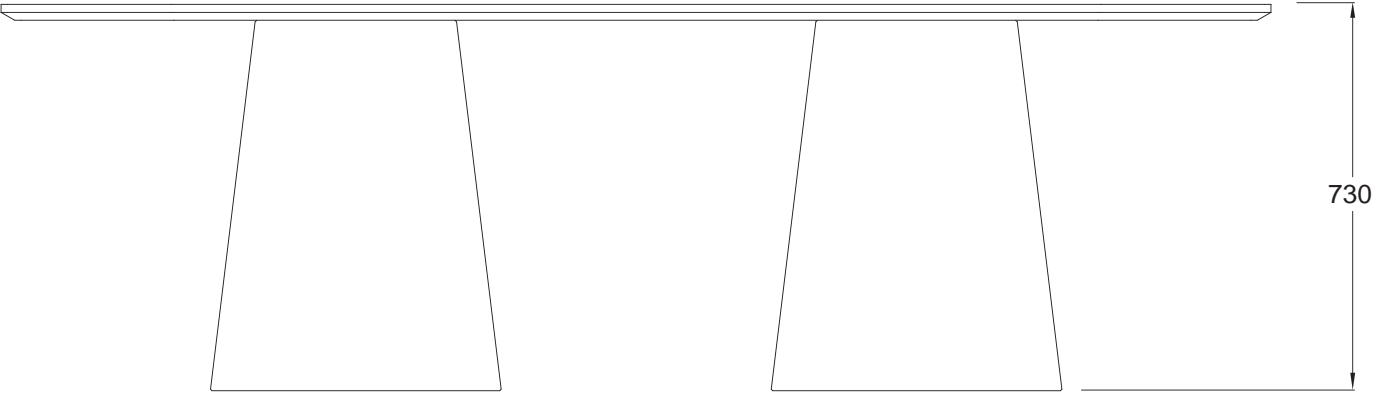
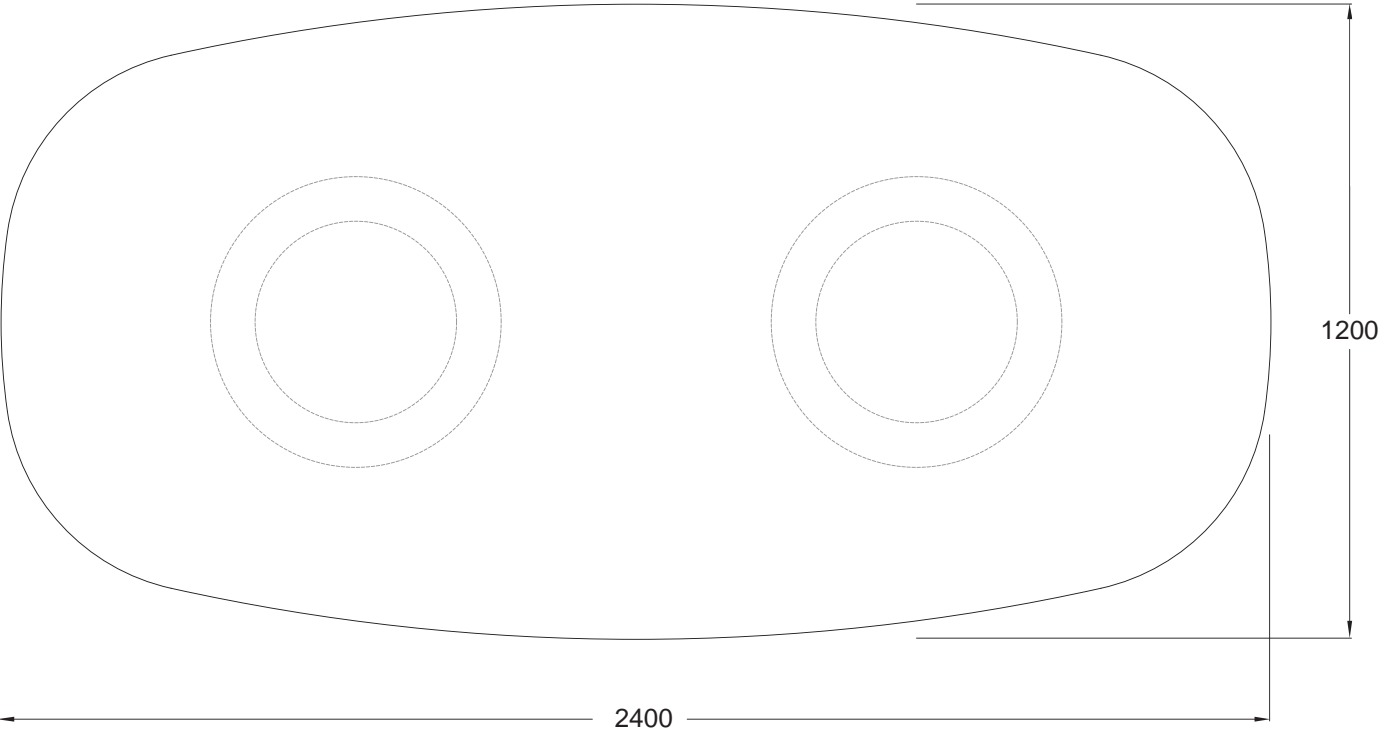

# LIQUEUR TABLE

LQ\_TB.270x120

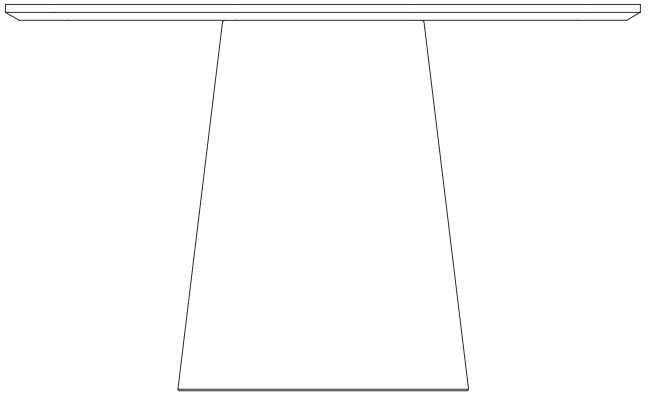
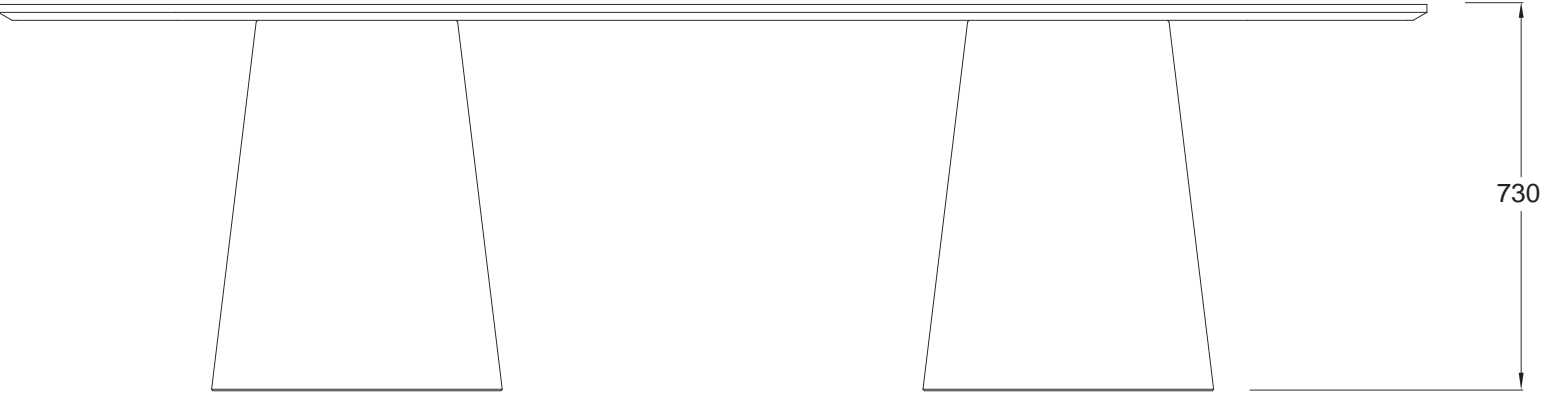
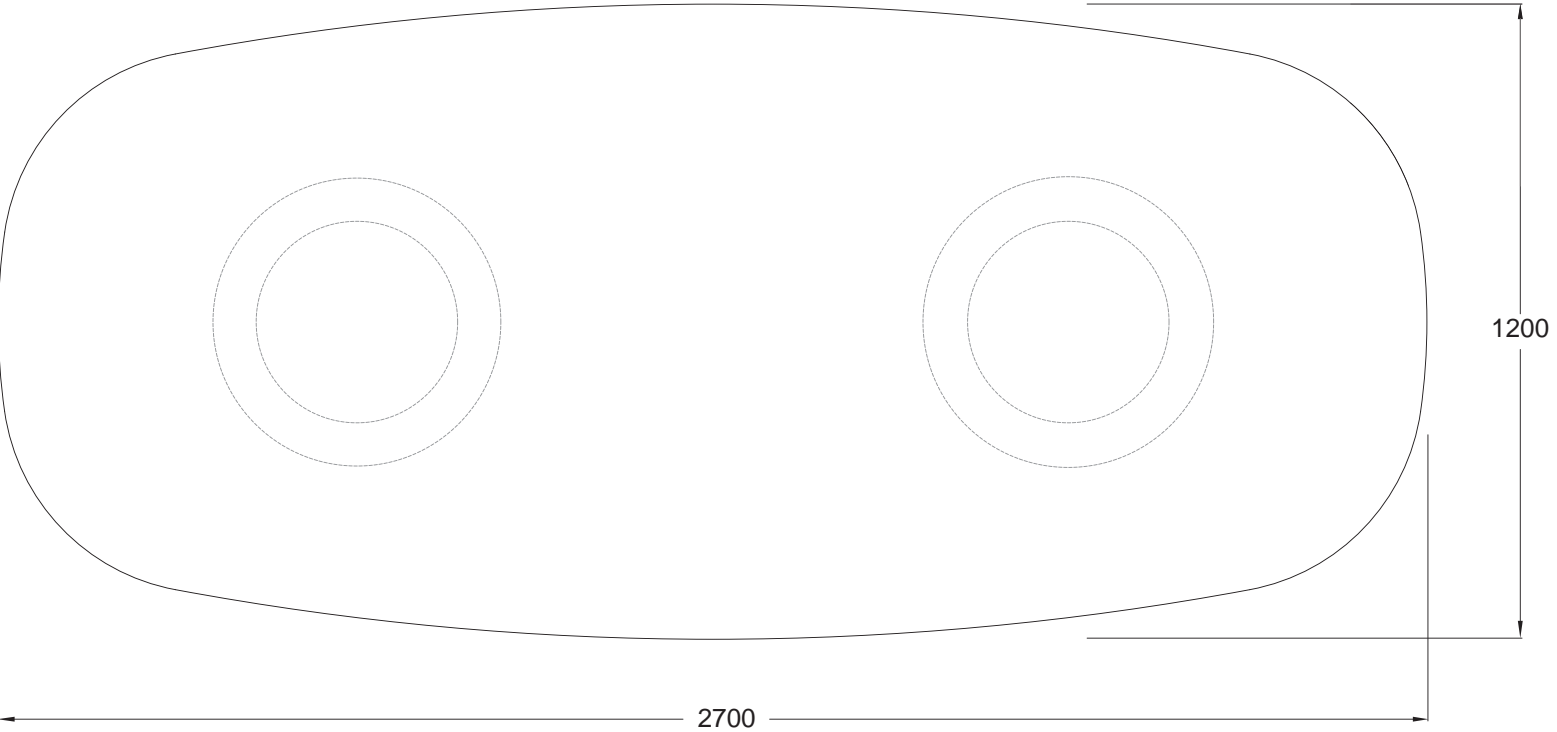

# LIQUEUR TABLE

LQ\_TB.300x120

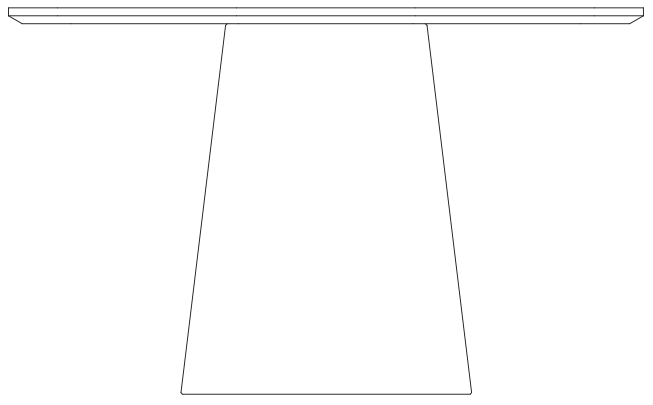
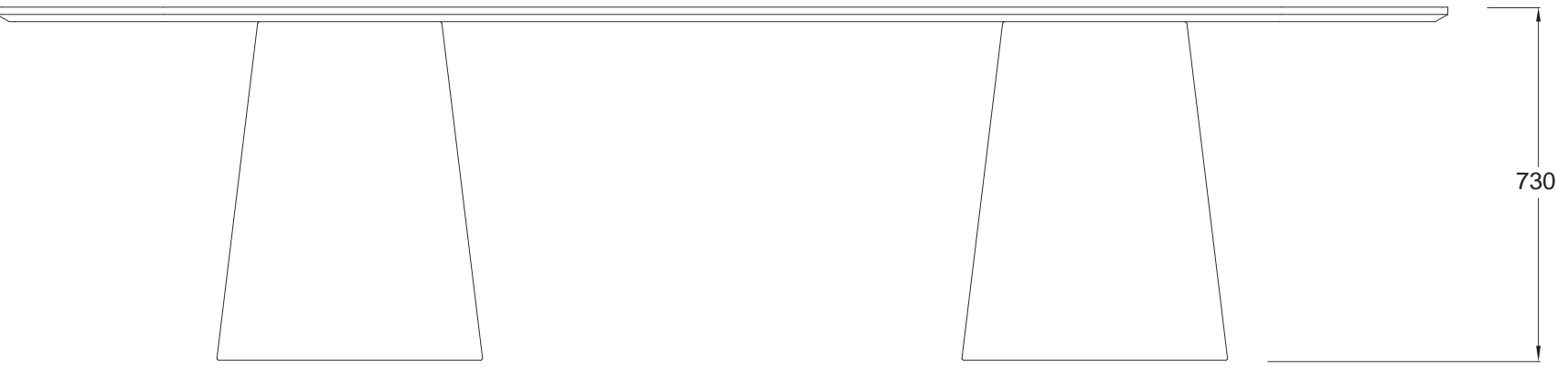
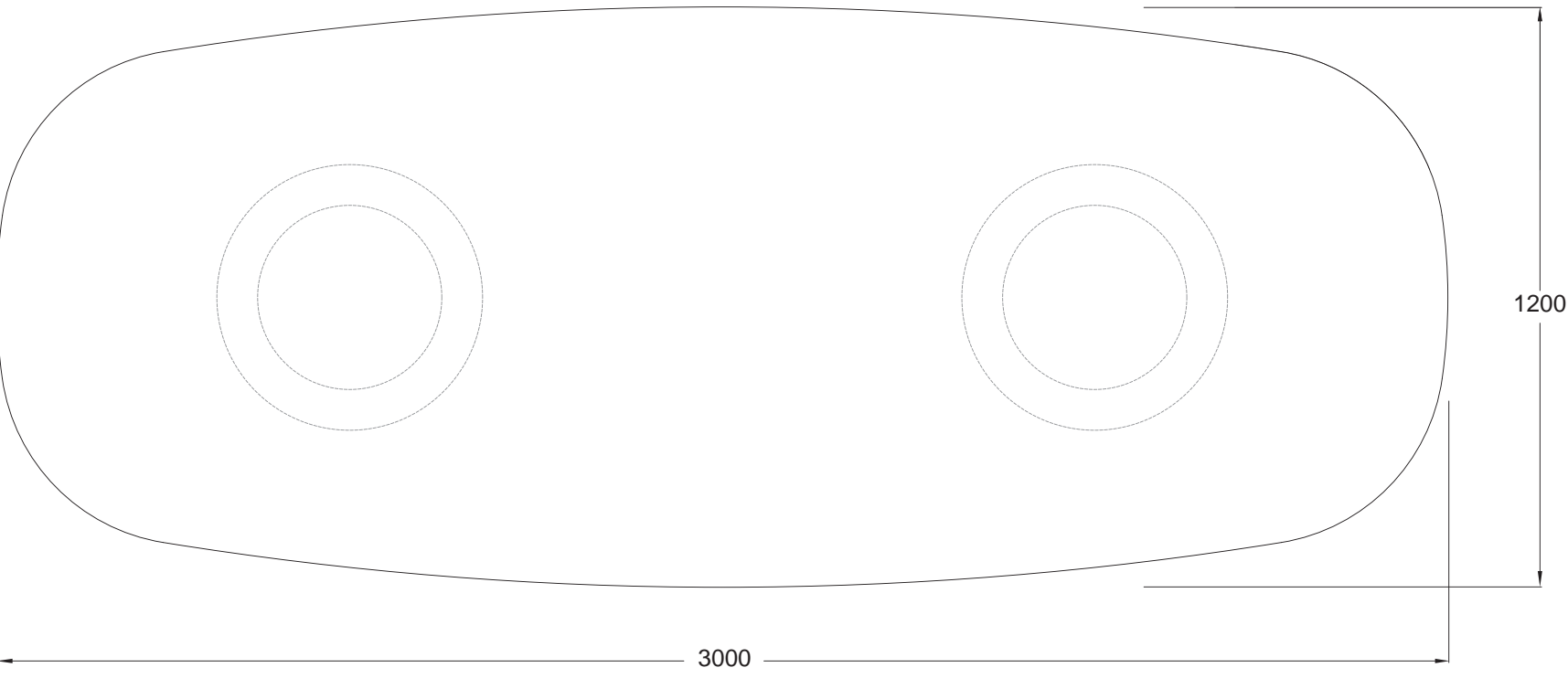

# LIQUEUR TABLE

LQ\_TB.330x120

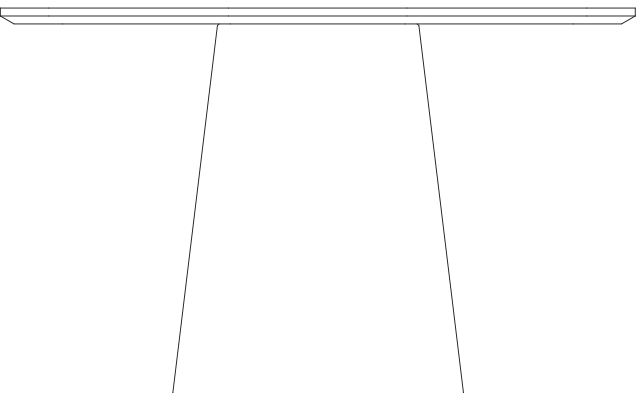
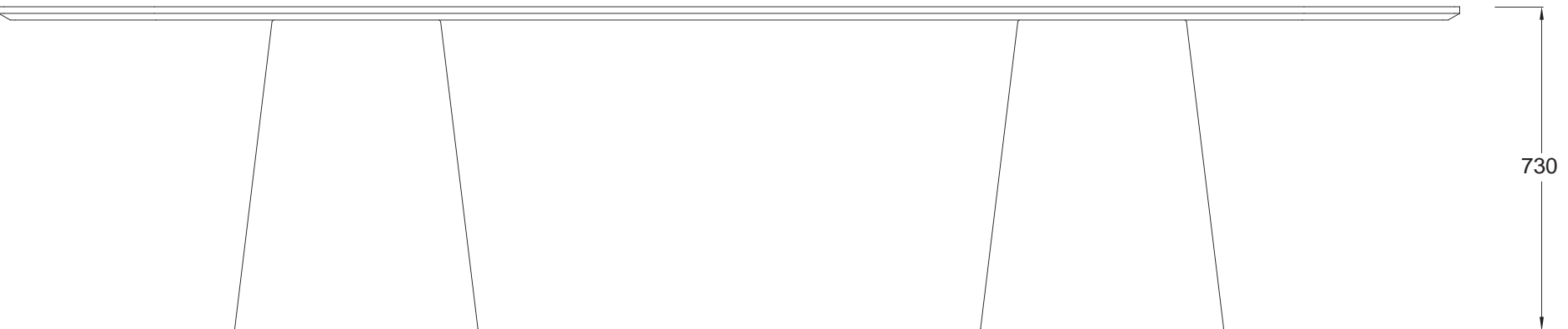
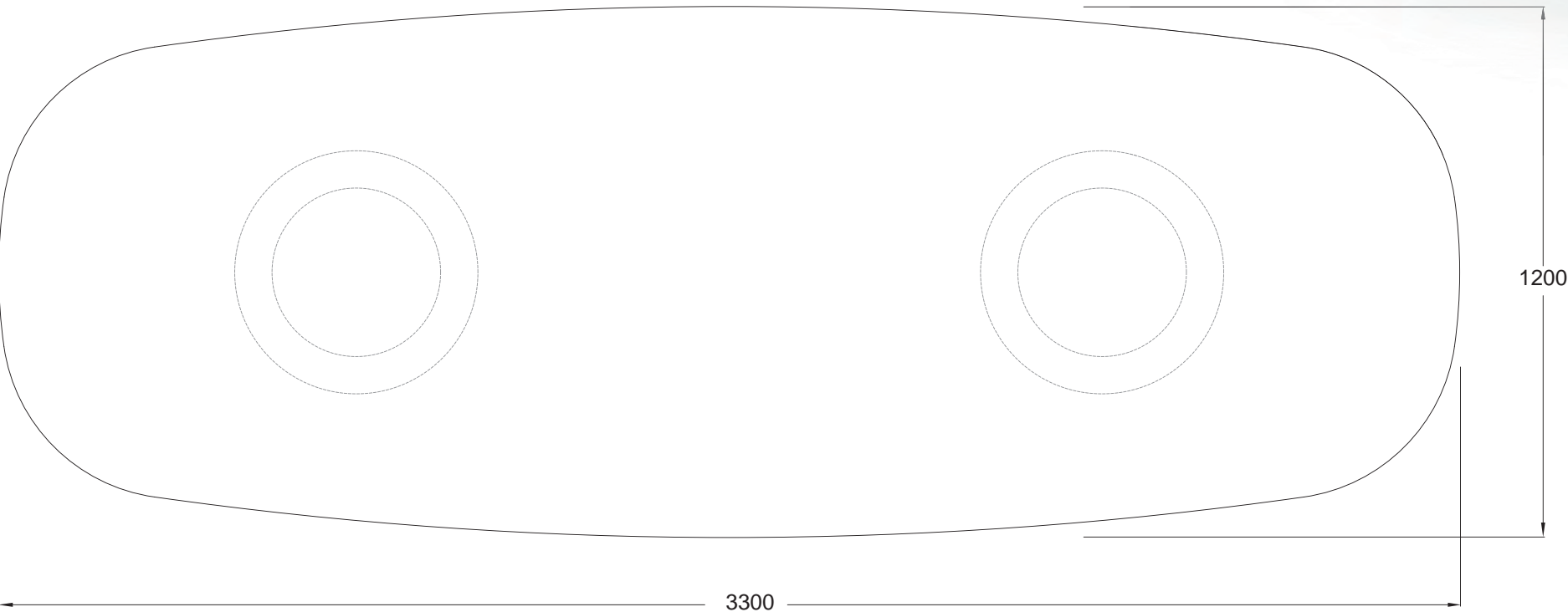

# LIQUEUR TABLE

LQ\_TB.360x120

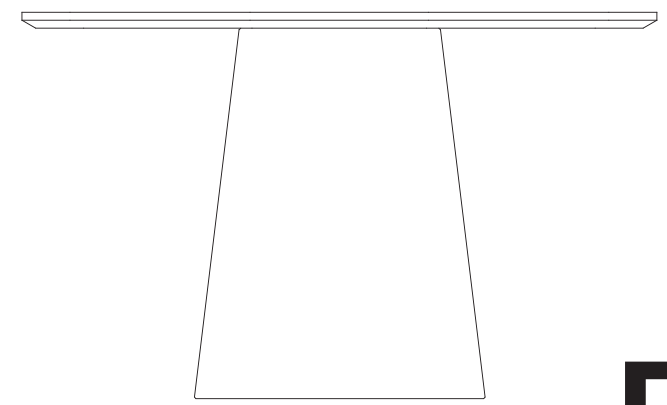
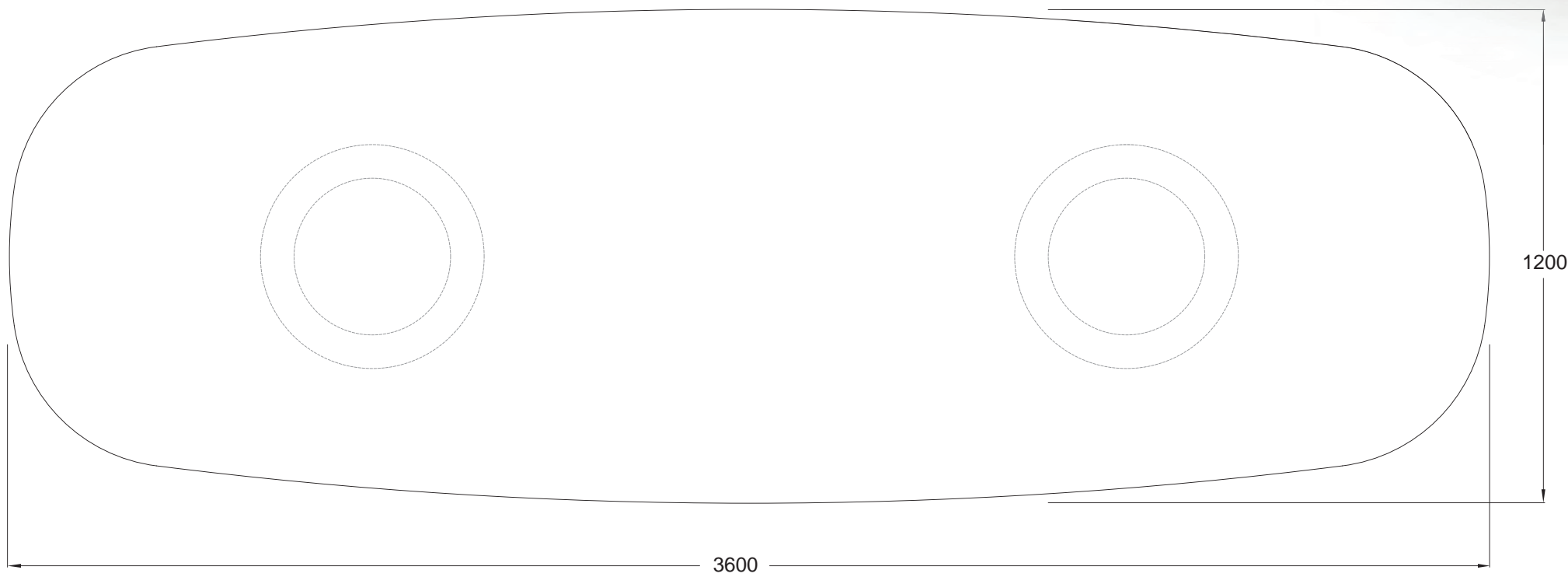

# LIQUEUR TABLE [RECTANGLE]

LQ\_TB.210x120[RECTANGLE]

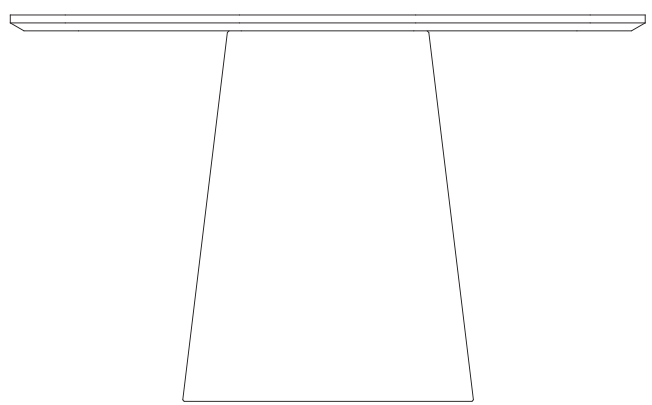
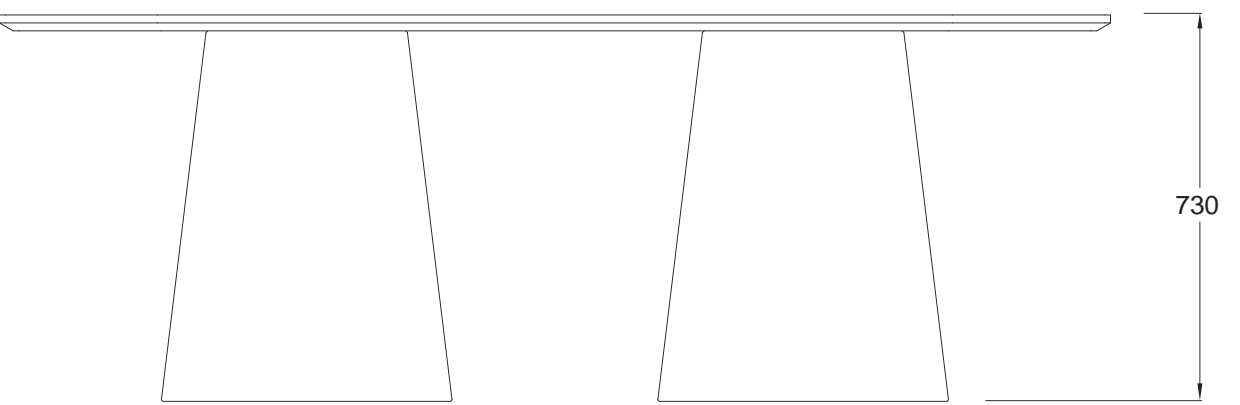
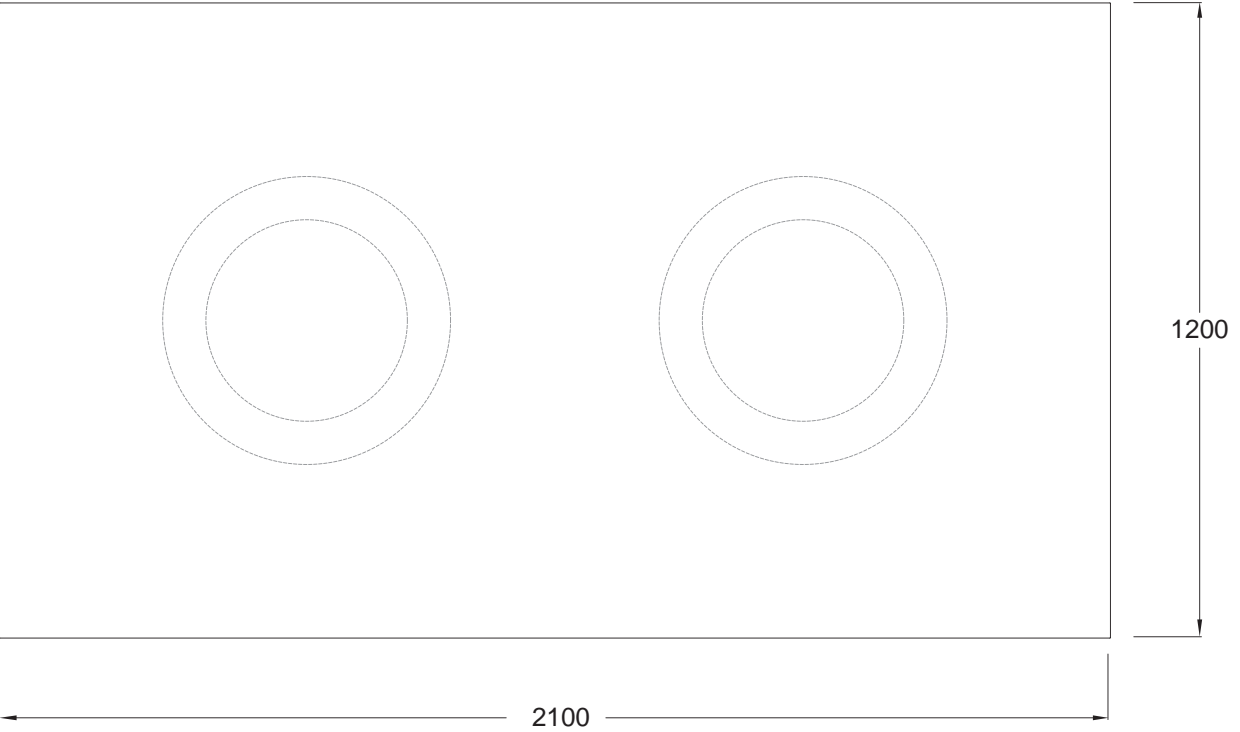

# LIQUEUR TABLE [RECTANGLE]

LQ\_TB.240x120[RECTANGLE]

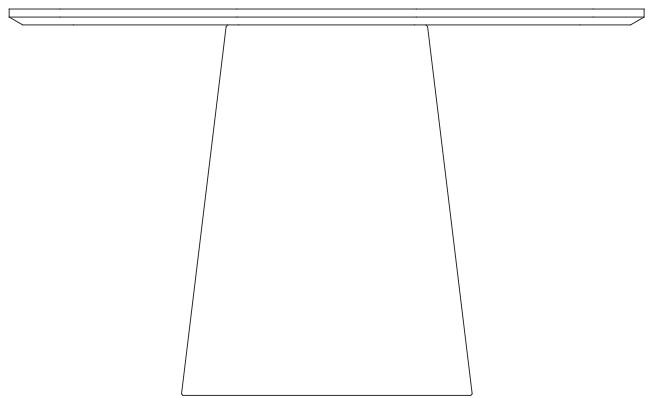
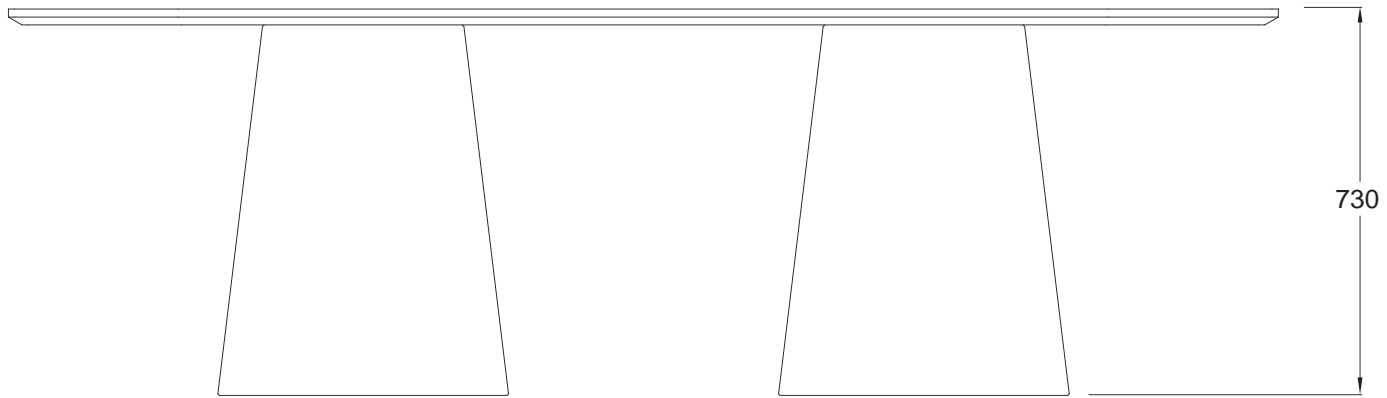
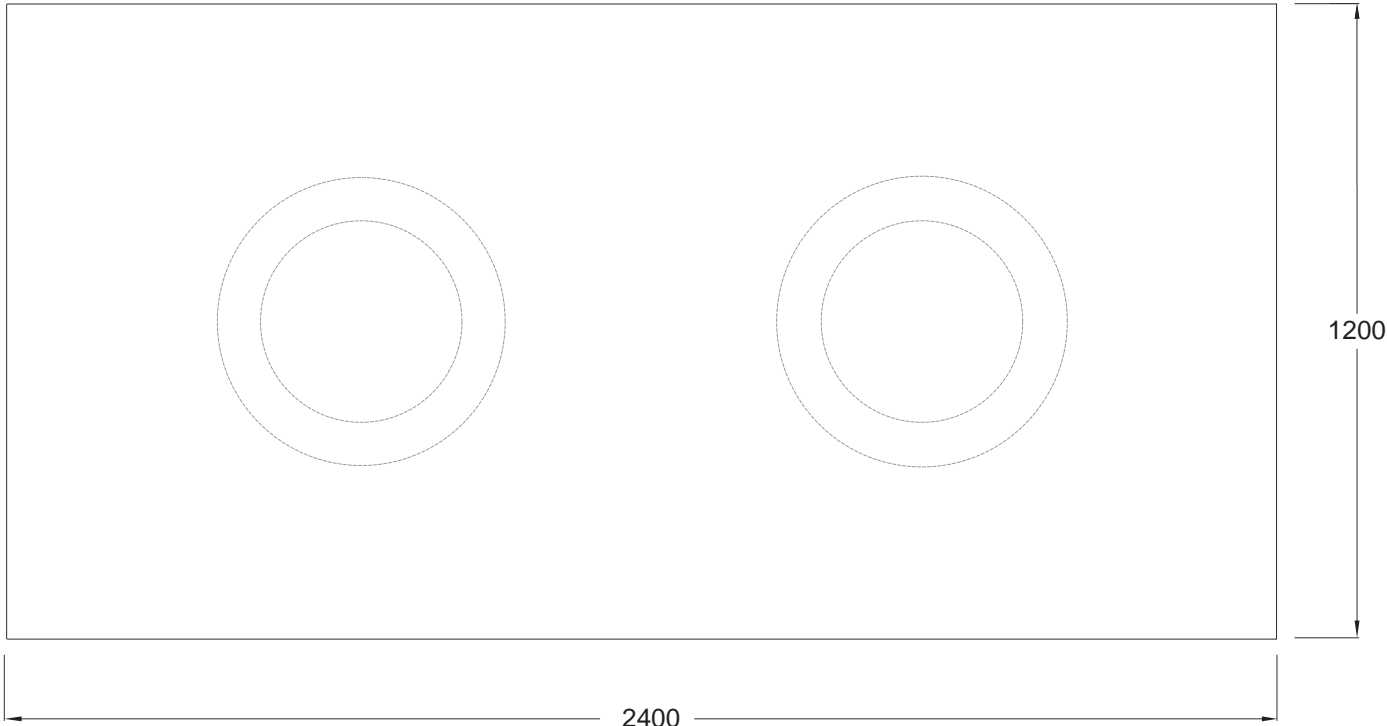



# LIQUEUR TABLE [RECTANGLE]

LQ\_TB.270x120[RECTANGLE]

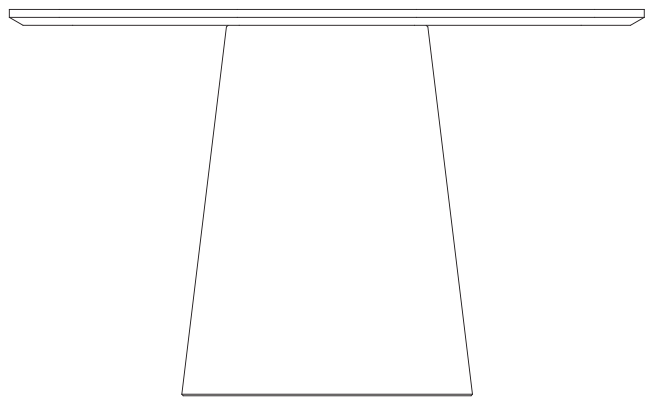
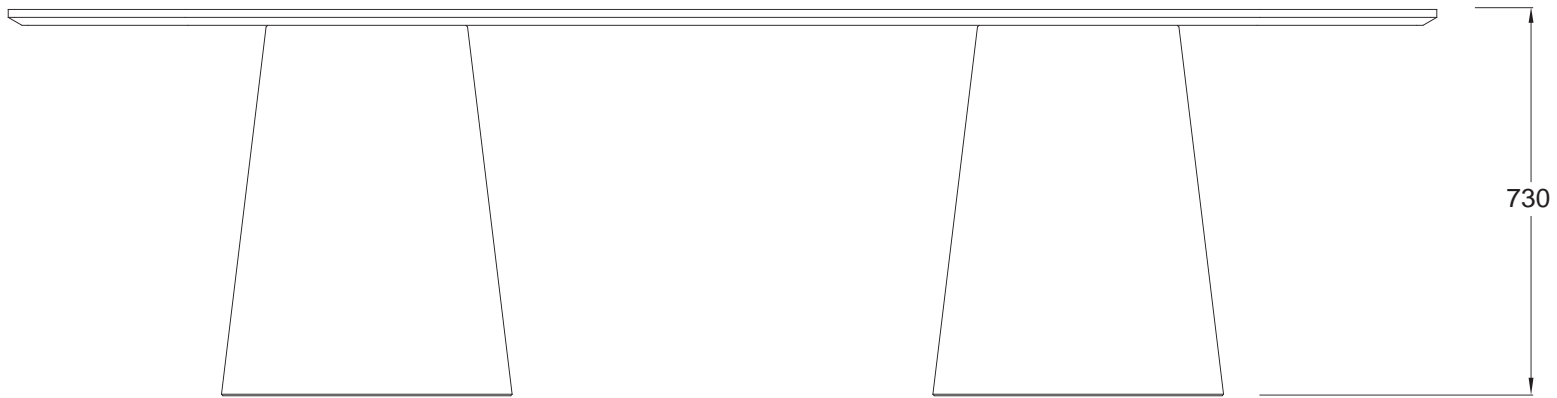
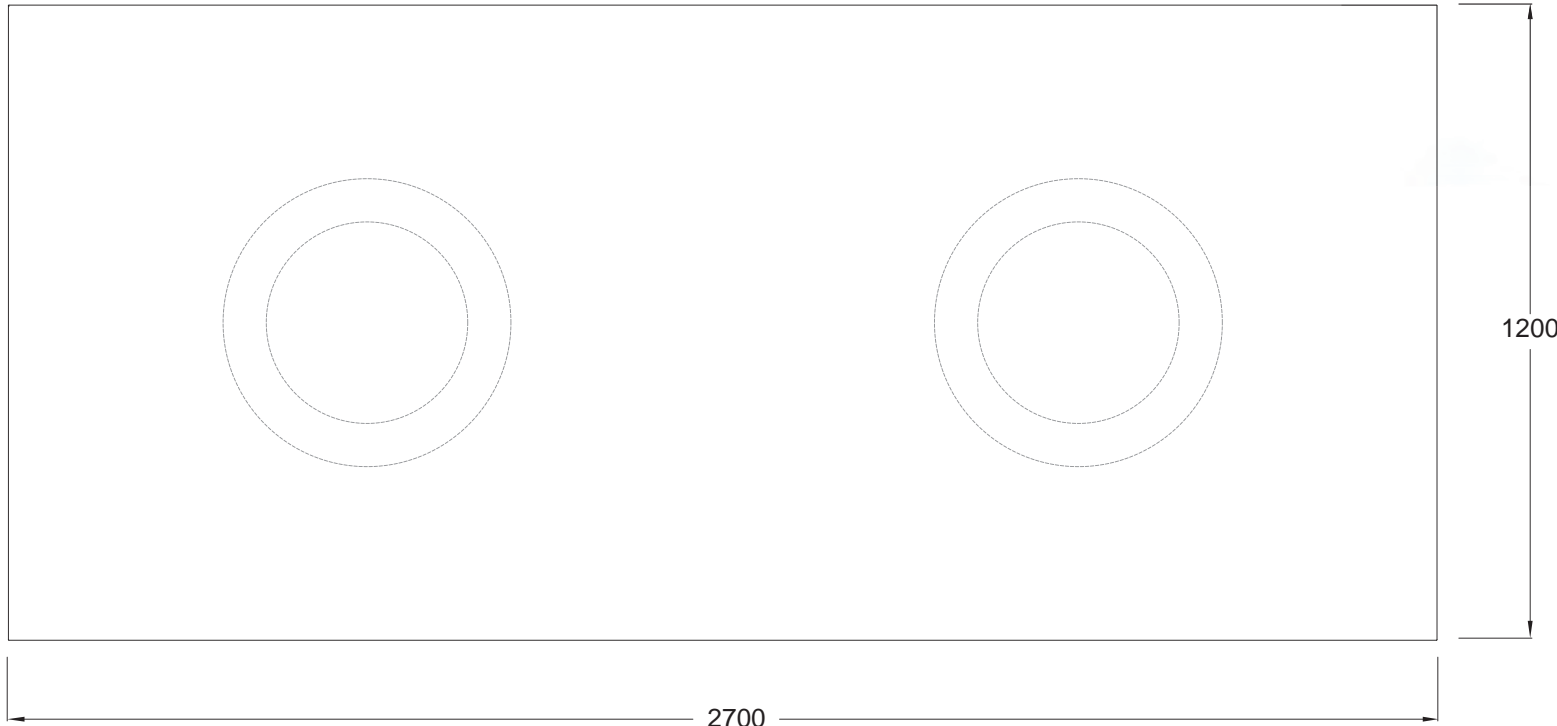



# LIQUEUR TABLE [RECTANGLE]

LQ\_TB.300x120[RECTANGLE]

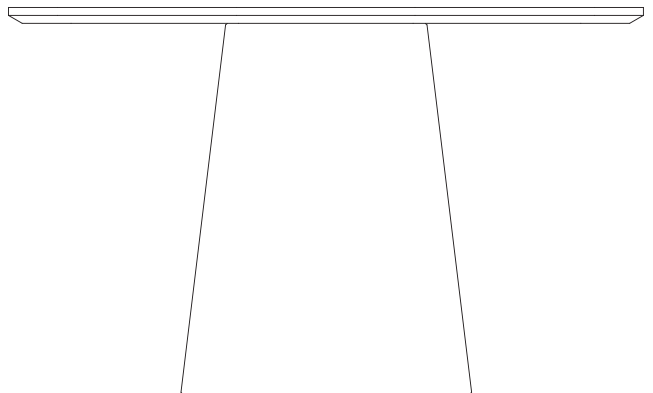
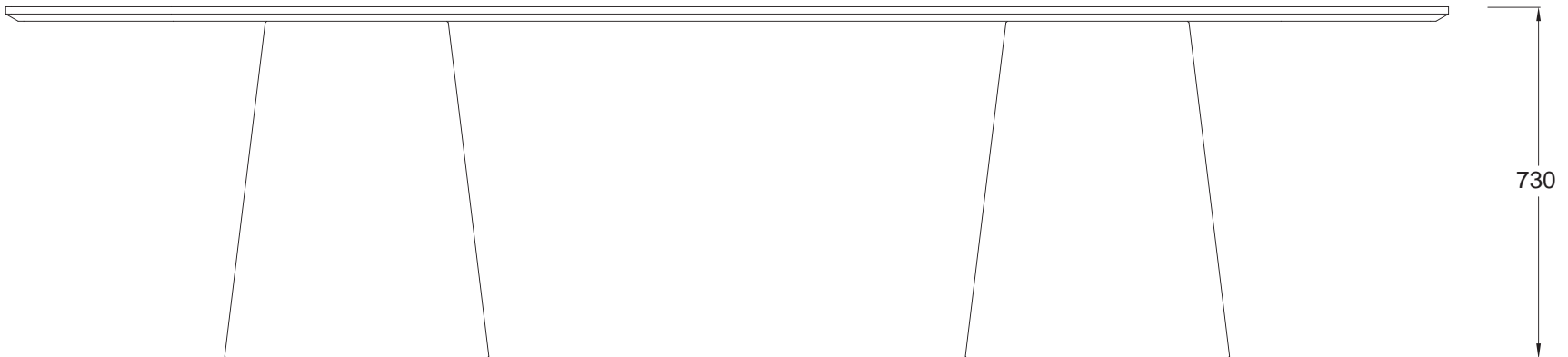
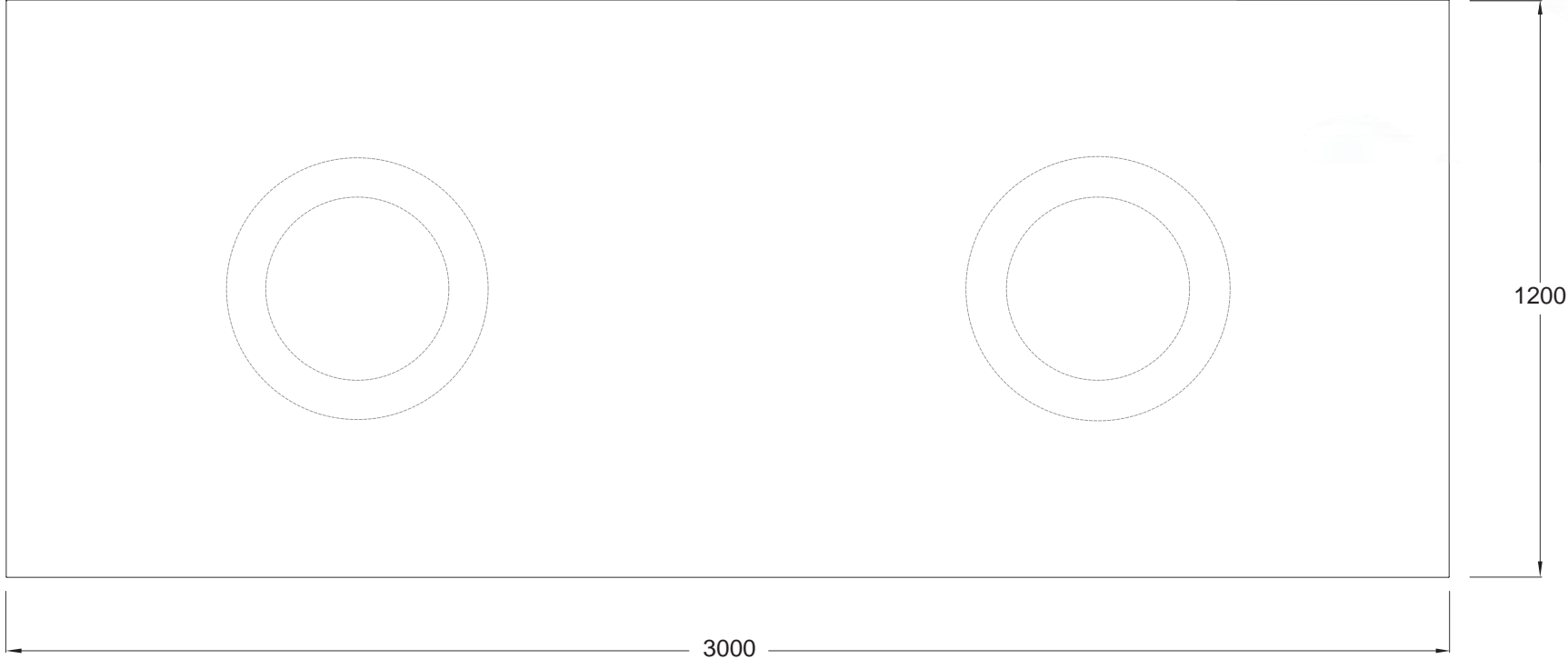

# LIQUEUR TABLE [RECTANGLE]

LQ\_TB.330x120[RECTANGLE]

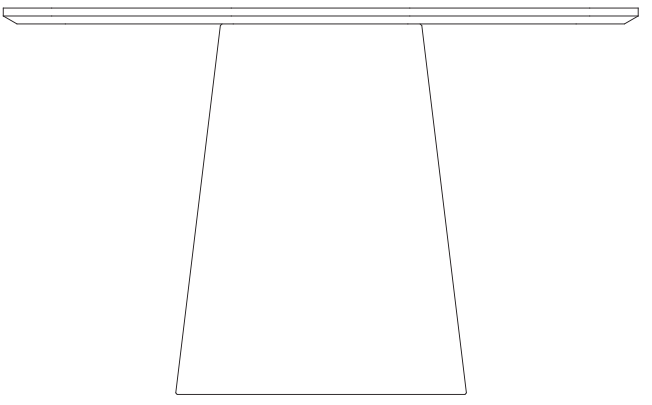
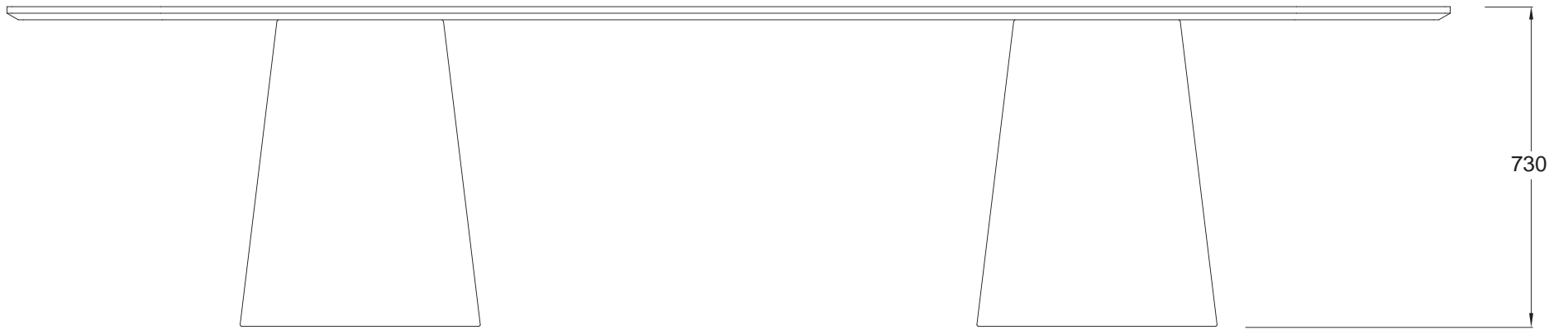
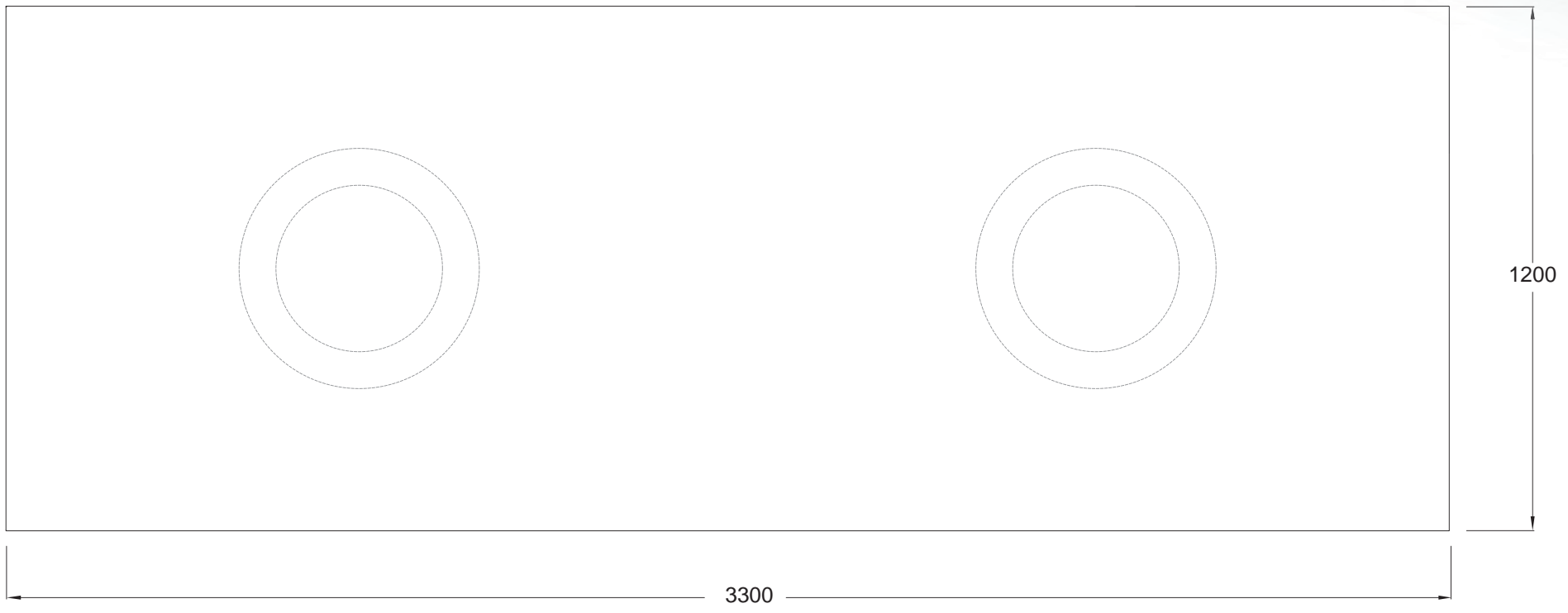

# LIQUEUR TABLE [RECTANGLE]

LQ\_TB.360x120[RECTANGLE]

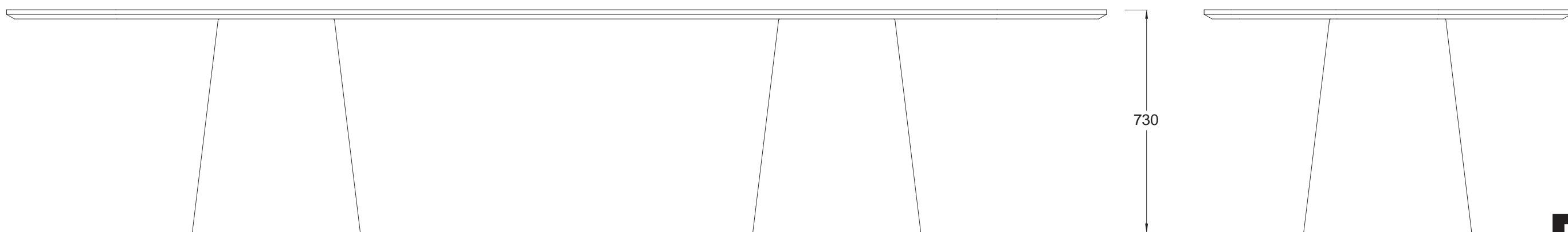
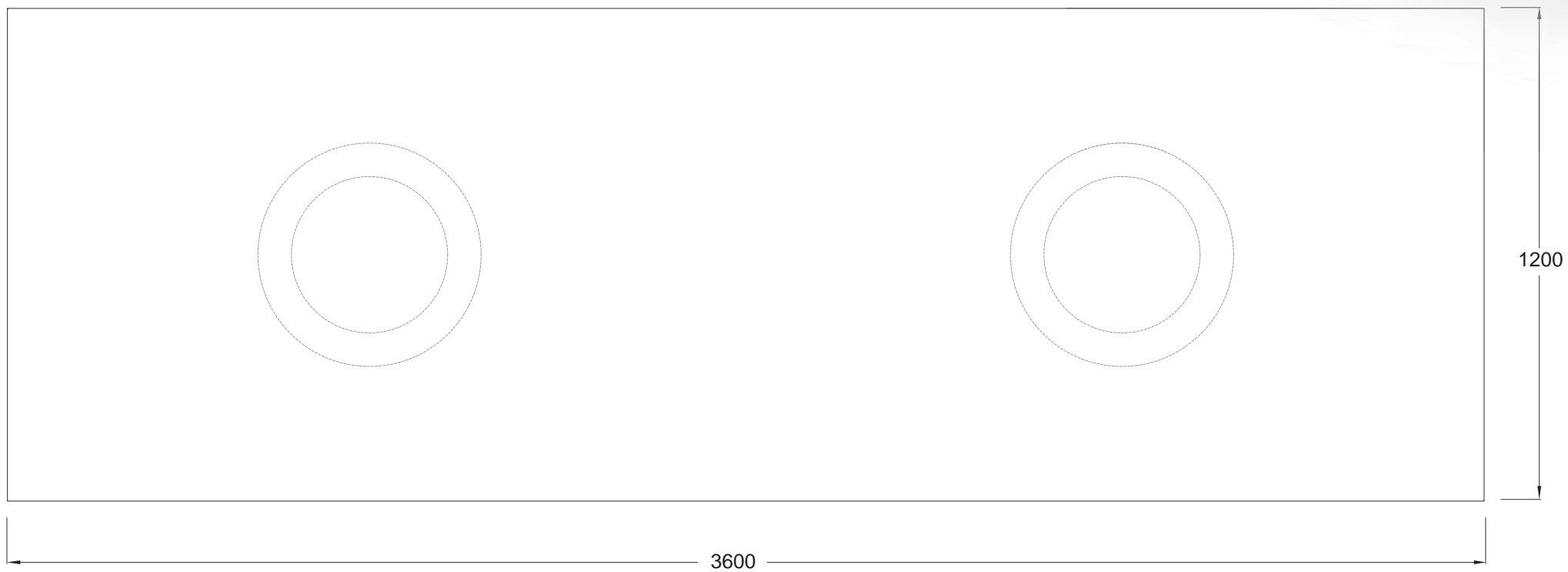

# LIQUEUR TABLE

LQ\_TB.270x135

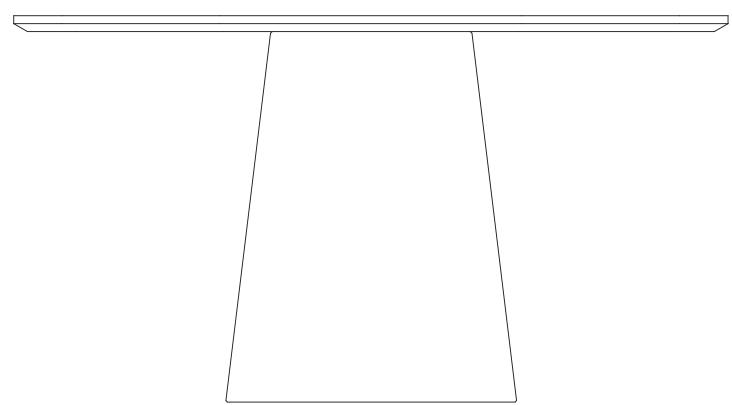
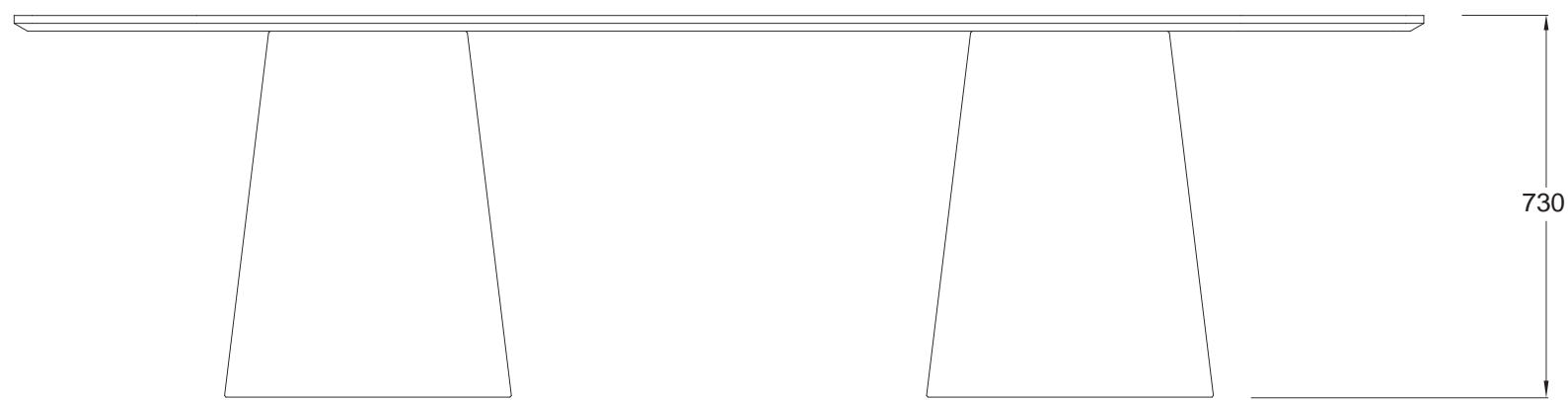
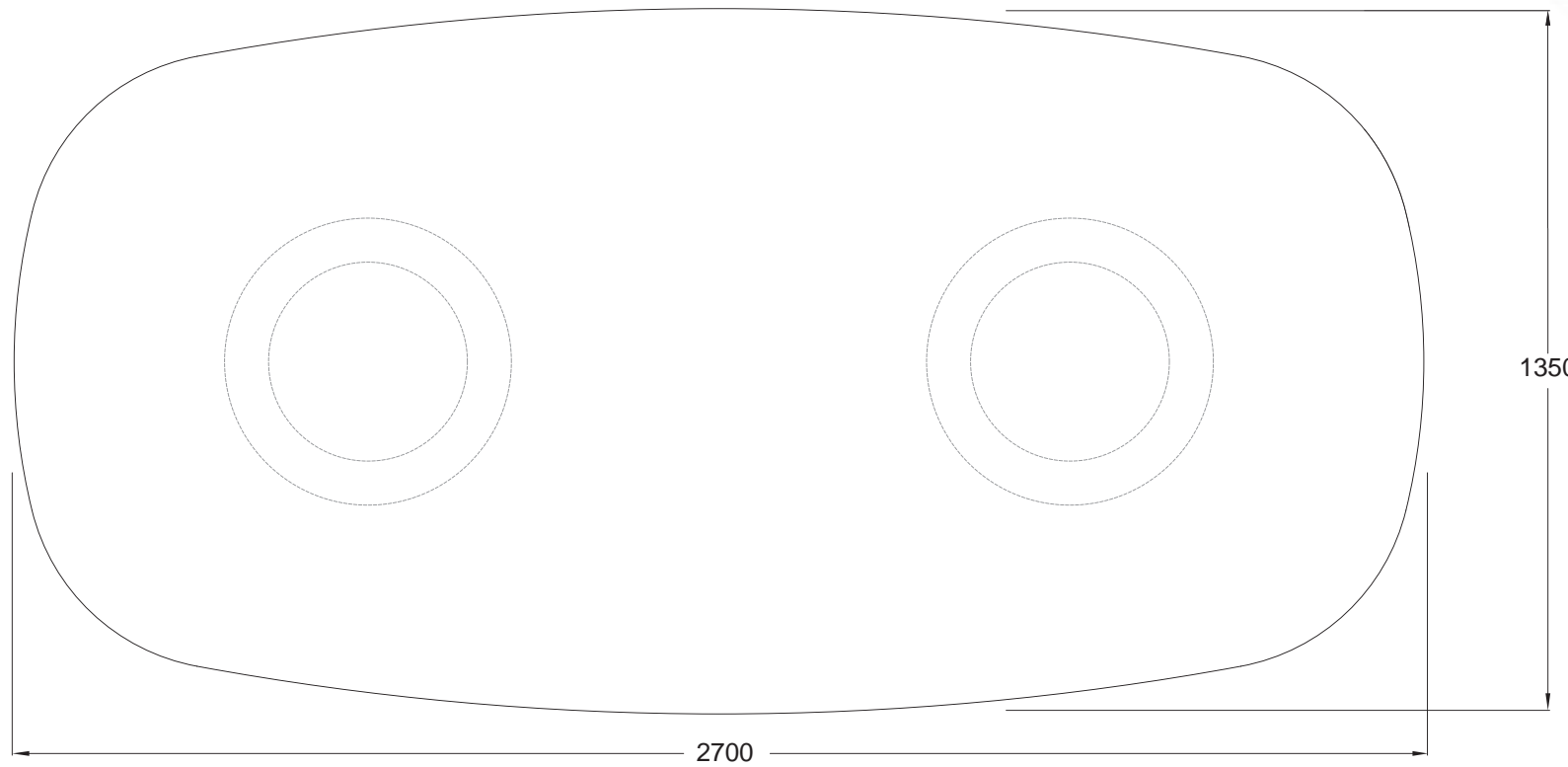

# LIQUEUR TABLE

LQ\_TB.300x135

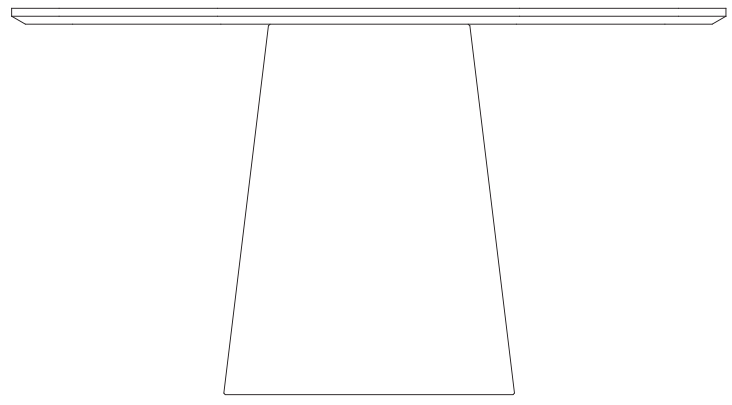
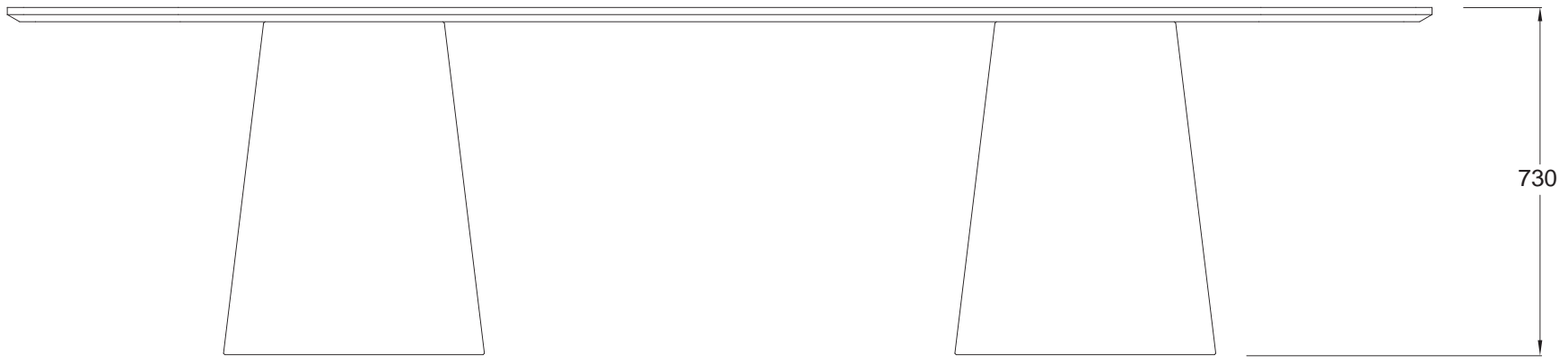
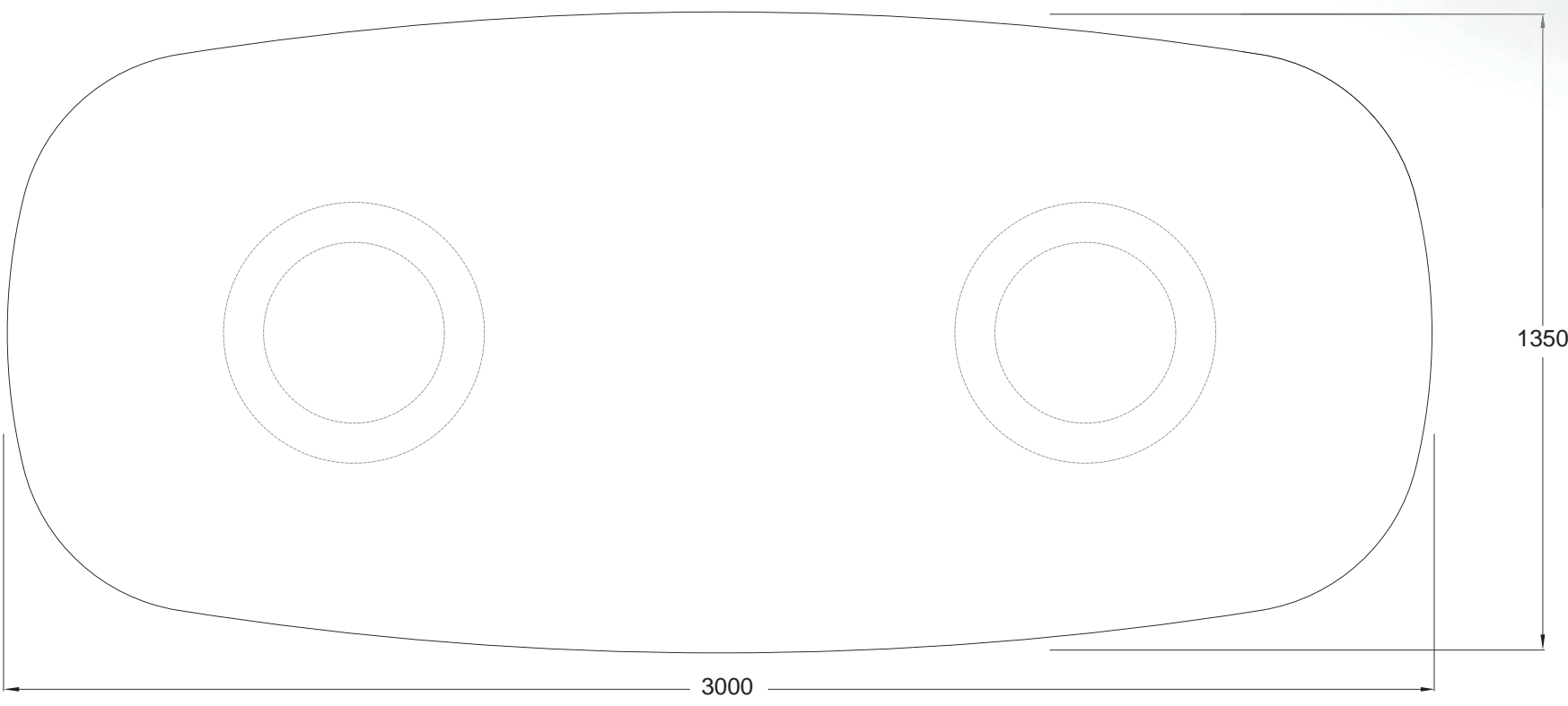

# LIQUEUR TABLE

LQ\_TB.330x135

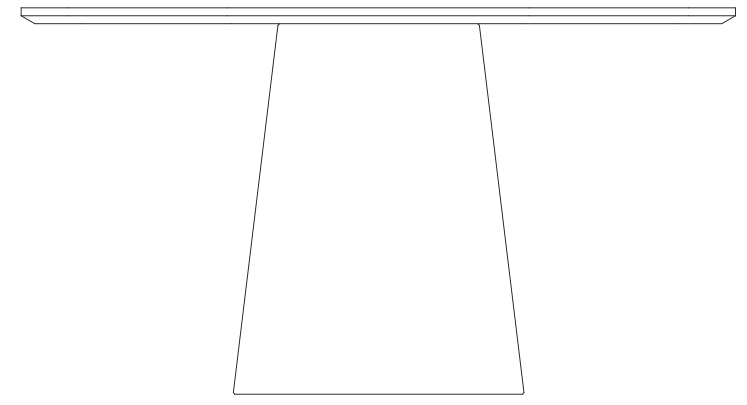
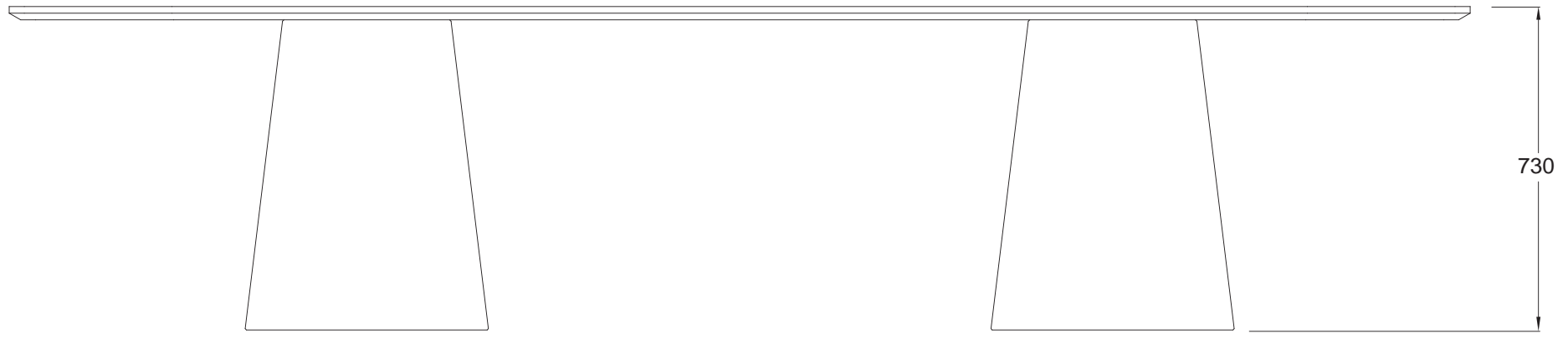
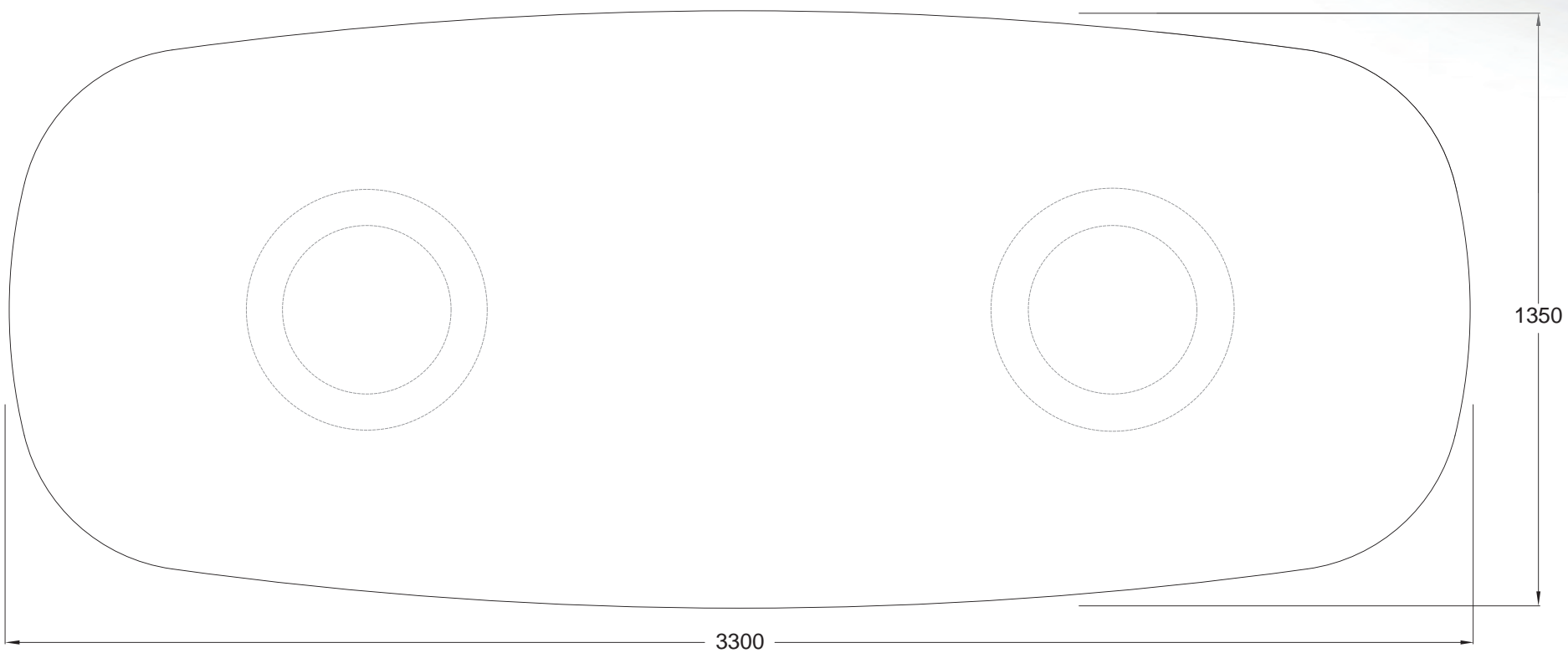



# LIQUEUR TABLE

LQ\_TB.360x135

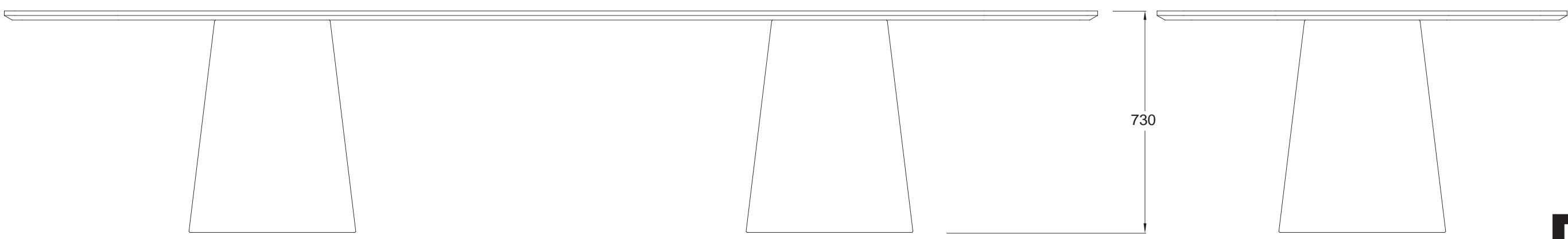
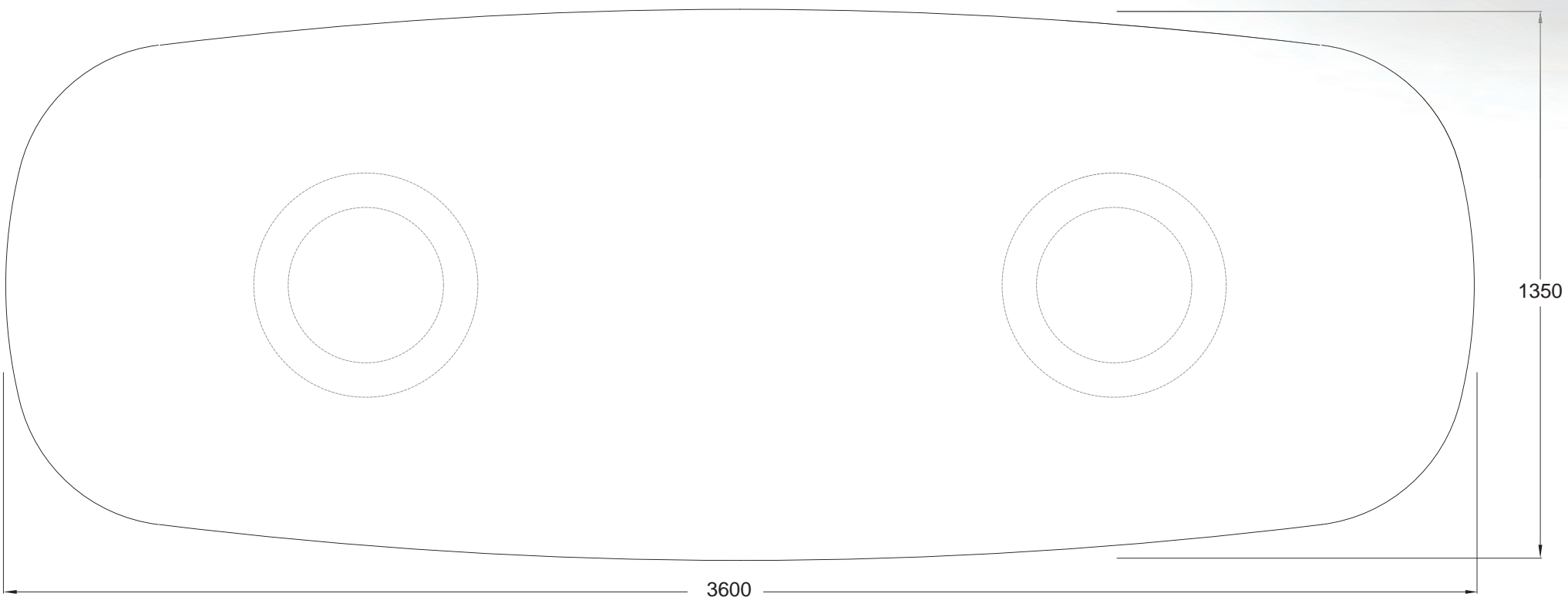

# LIQUEUR TABLE [RECTANGLE]

LQ\_TB.270x135[RECTANGLE]

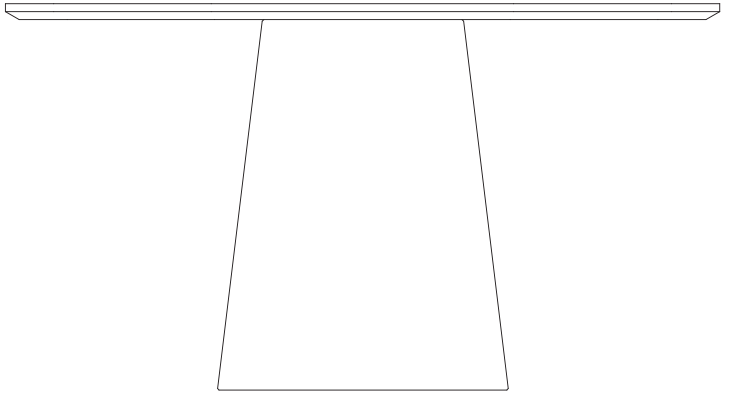
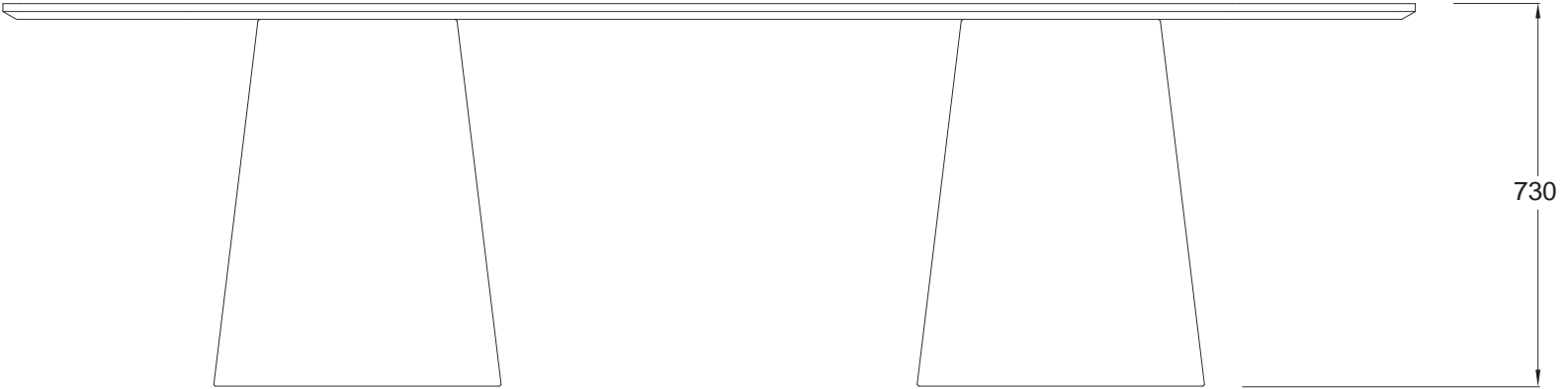
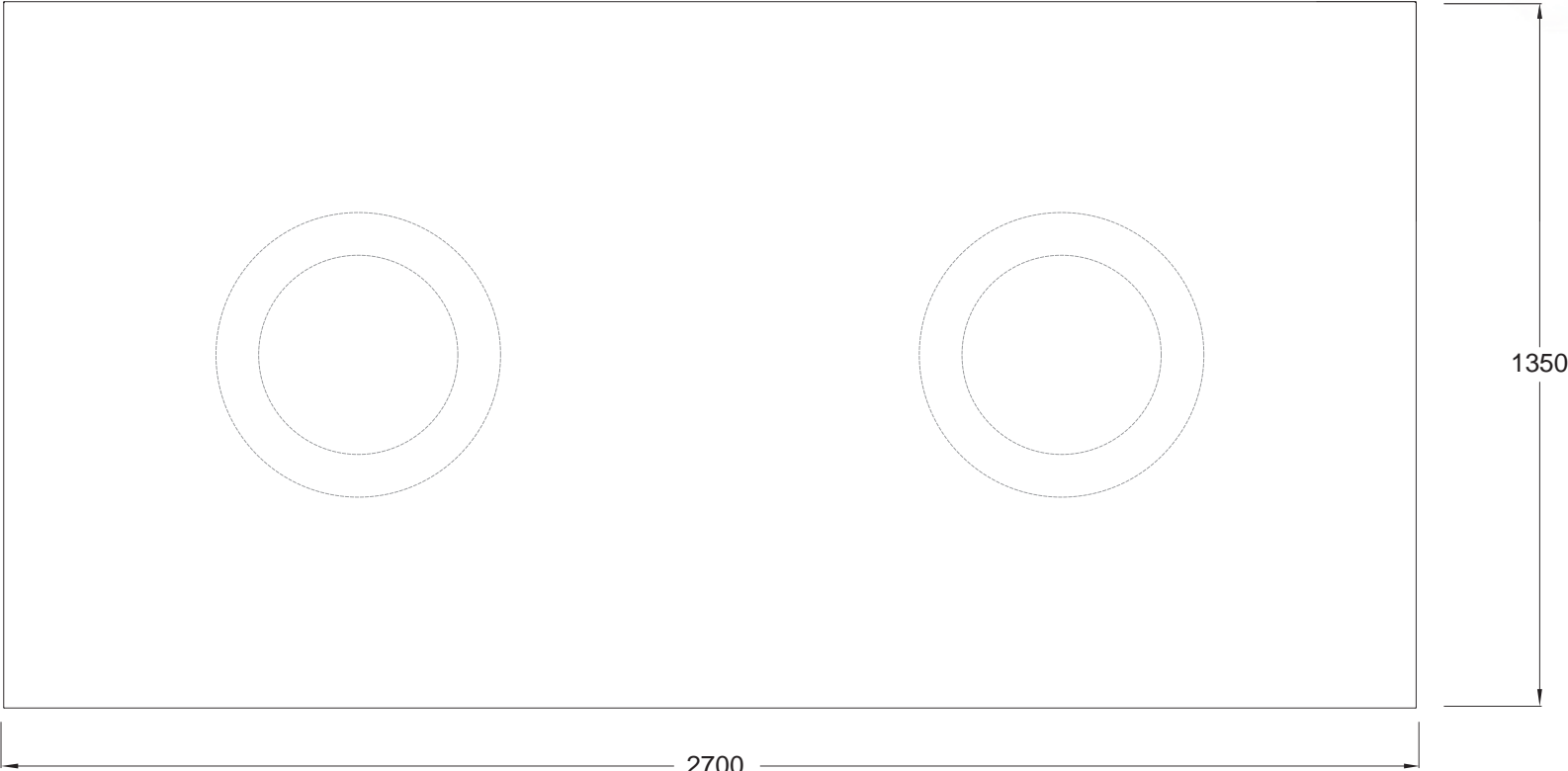



# LIQUEUR TABLE [RECTANGLE]

LQ\_TB.300x135[RECTANGLE]

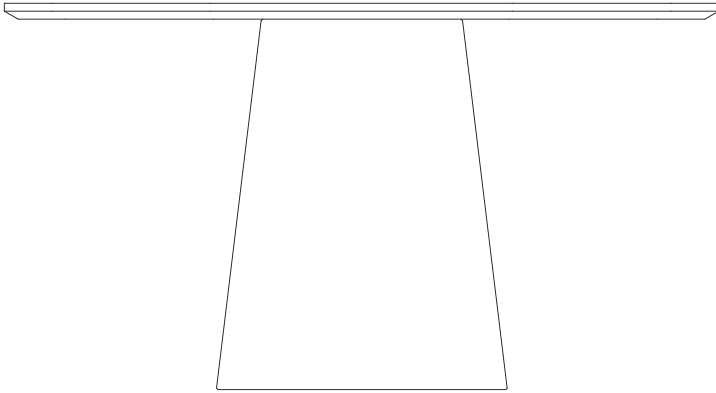
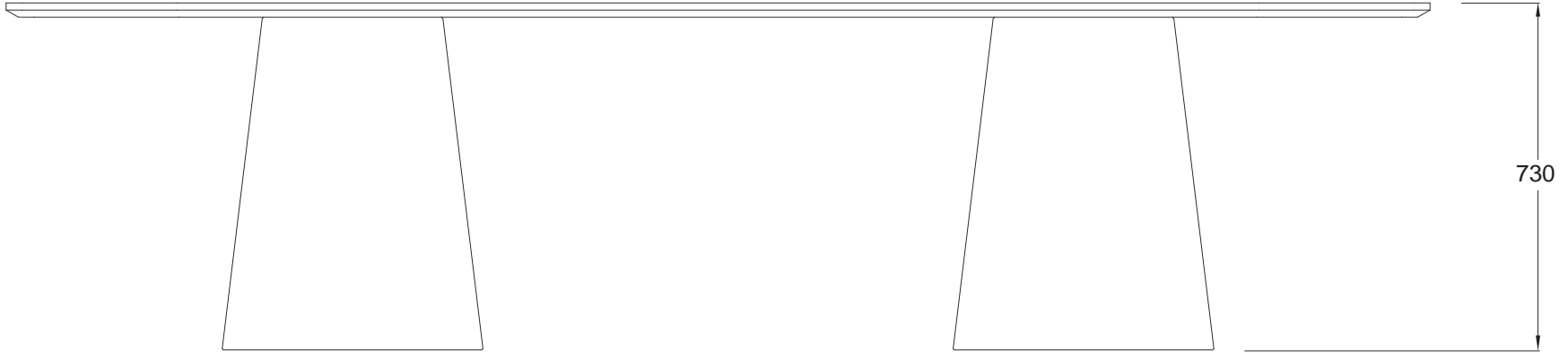
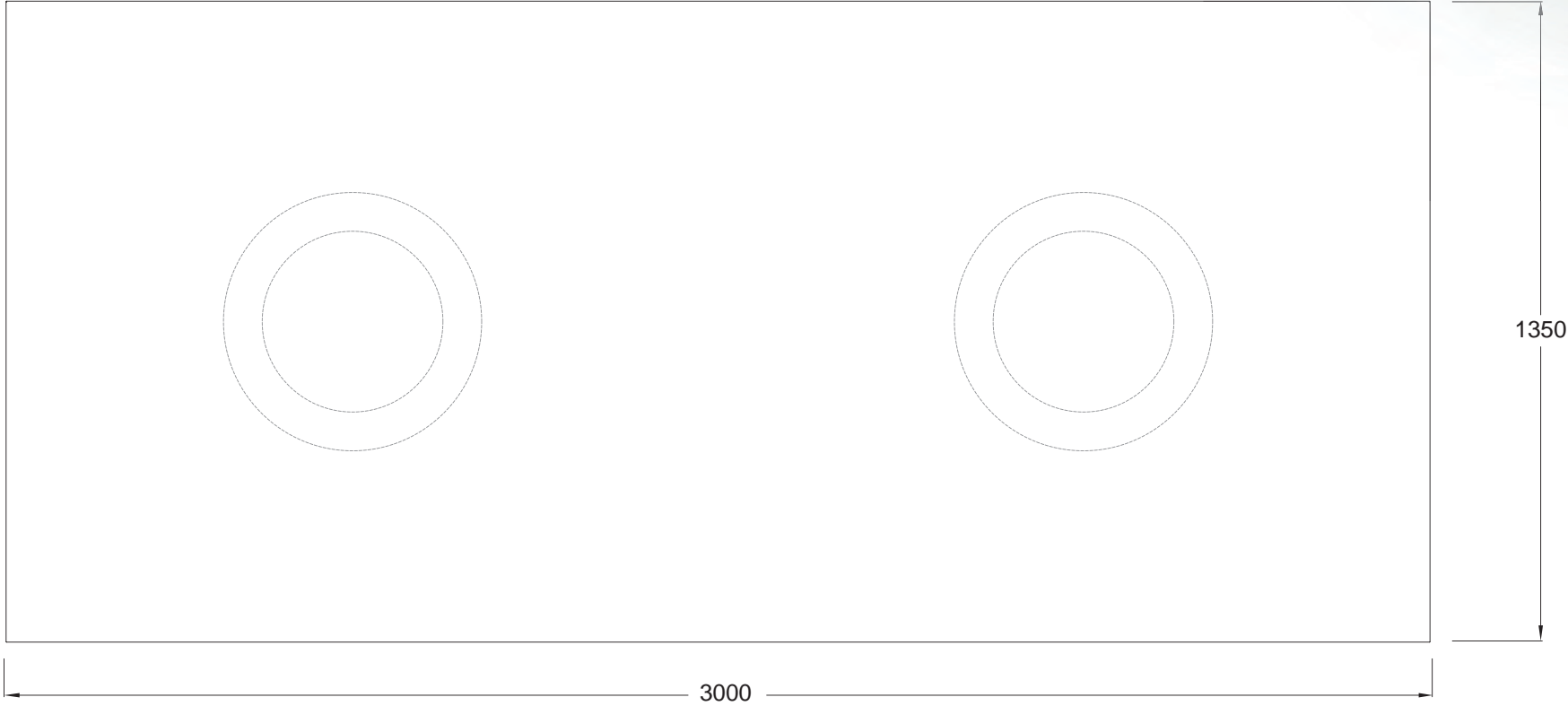

# LIQUEUR TABLE [RECTANGLE]

LQ\_TB.330x135[RECTANGLE]

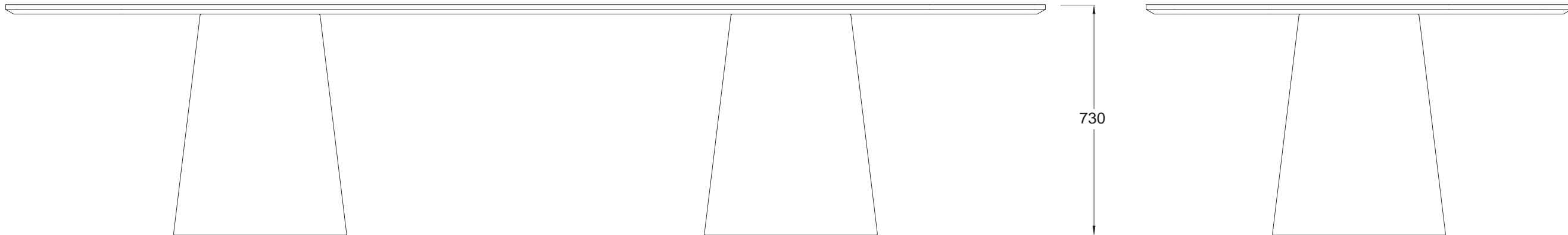
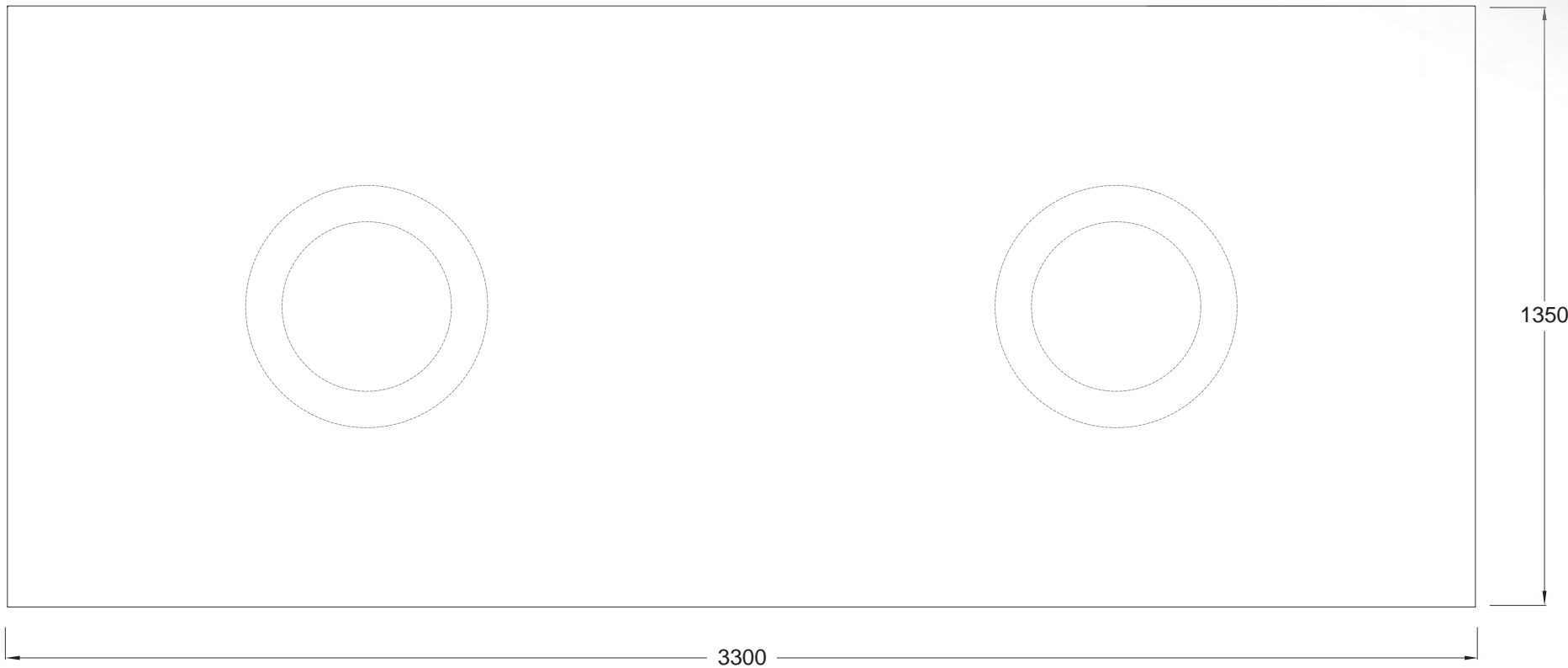

# LIQUEUR TABLE [RECTANGLE]

LQ\_TB.360x135[RECTANGLE]

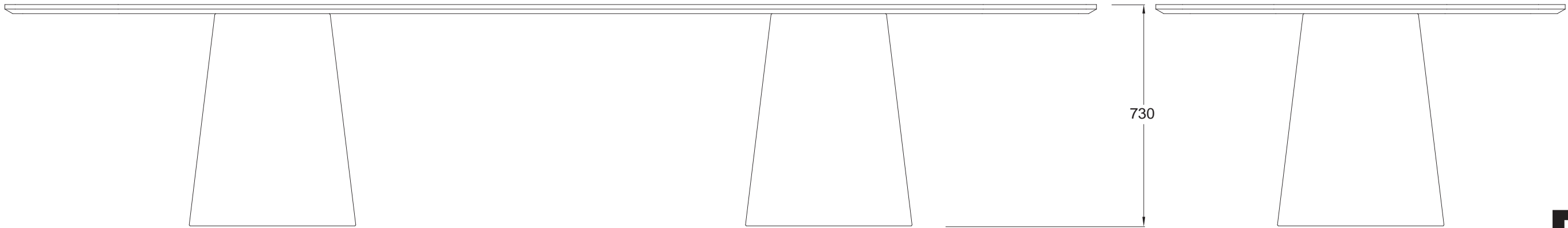
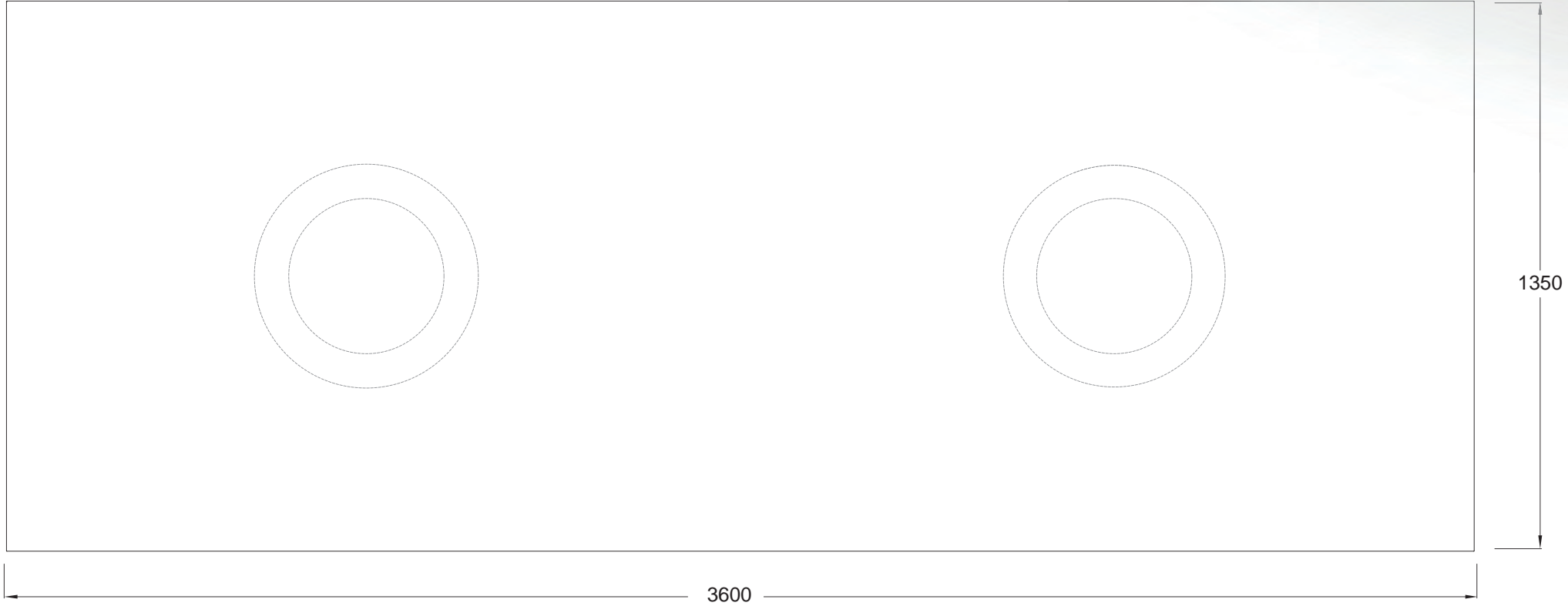

# LIQUEUR TABLE (EXT) - CONFIG A

LQ\_EXT\_55D+40 X4

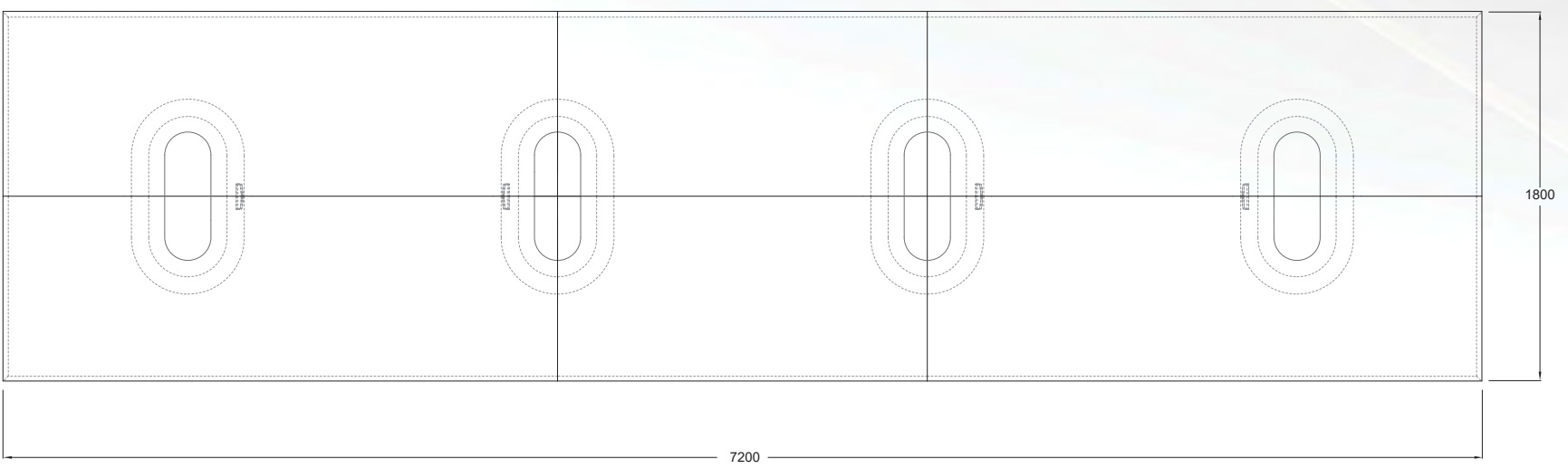



# LIQUEUR TABLE (EXT) - CONFIG A

LQ\_EXT\_55D+40 X4



# LIQUEUR TABLE (EXT) - CONFIG B

LQ\_EXT\_55D+20 X3

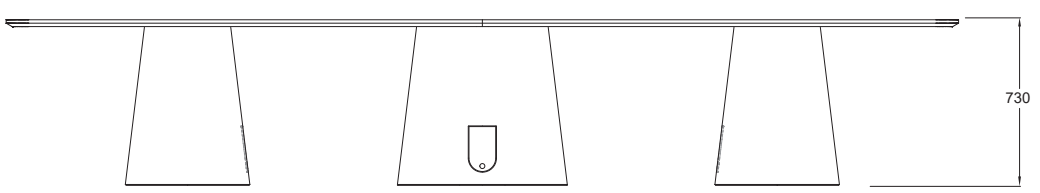
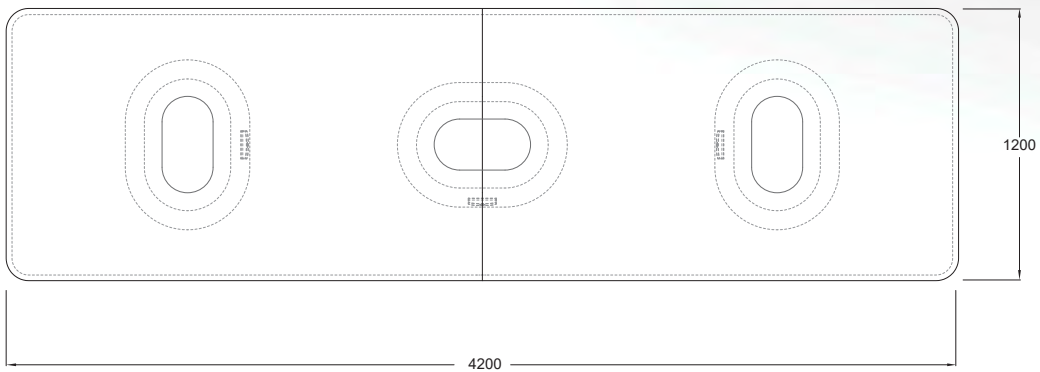



# LIQUEUR TABLE (EXT) - CONFIG B

LQ\_EXT\_55D+20 X3



# LIQUEUR TABLE (EXT) - CONFIG C

LQ\_EXT\_55D+20 X2

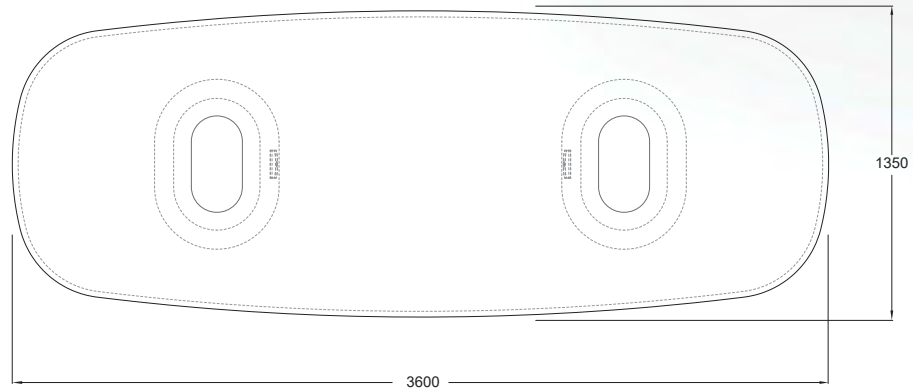



# LIQUEUR TABLE (EXT) - CONFIG C

LQ\_EXT\_55D+20 X2



# LIQUEUR TABLE (EXT) - CONFIG D

LQ\_EXT.BAR\_55D+40 X1

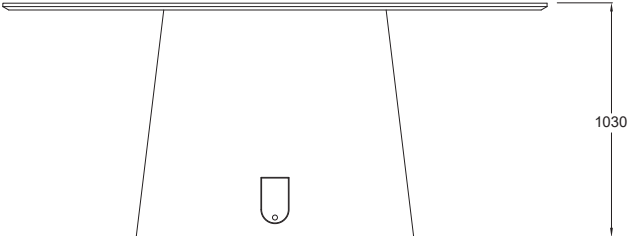
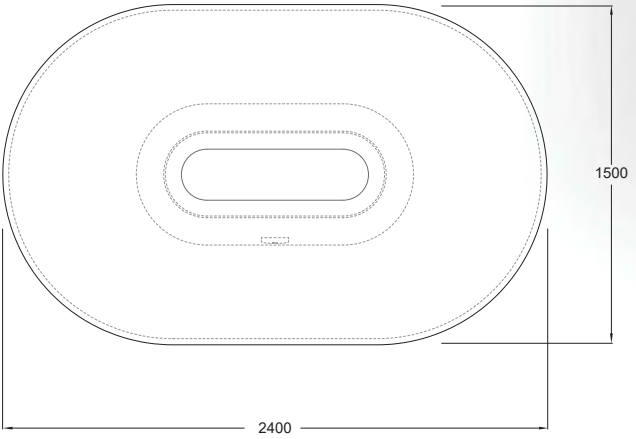

# LIQUEUR TABLE (EXT) - CONFIG D

LQ\_EXT.BAR\_55D+40 X1

