

# PUFFALO MODULAR DESKING (HI)

PF-BDK[HI].65X40

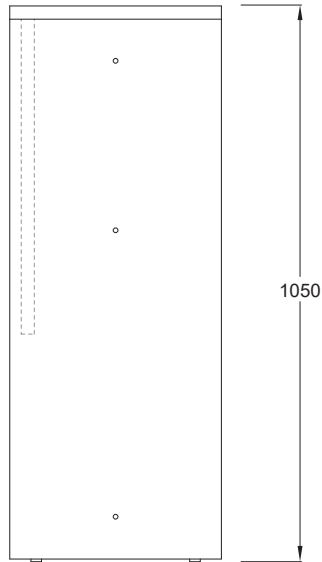
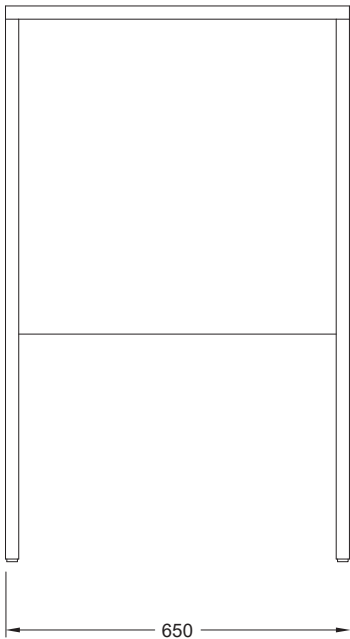
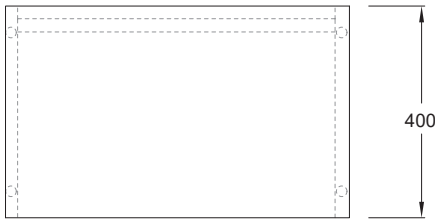

# PUFFALO MODULAR DESKING (HI)

PF-BDK[HI].65x60

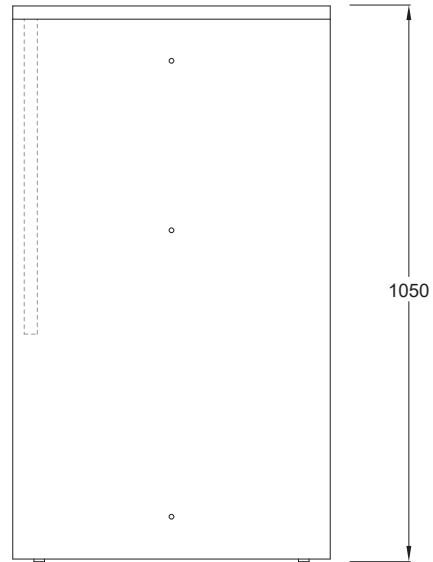
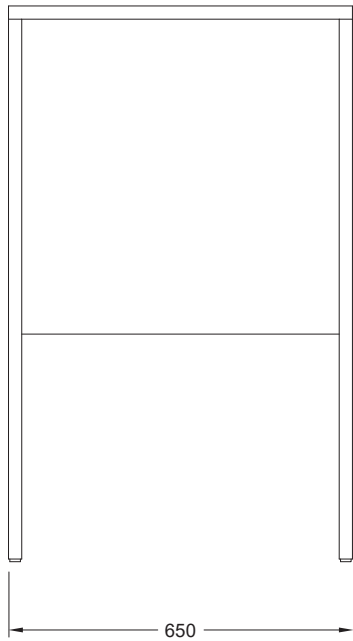
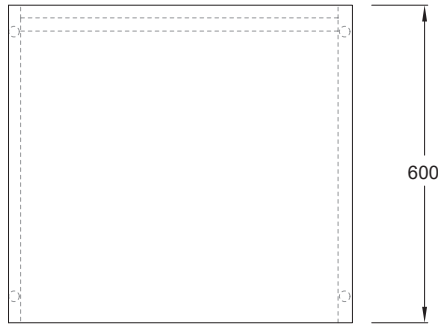

# PUFFALO MODULAR DESKING (HI)

PF-BDK[HI].78x40

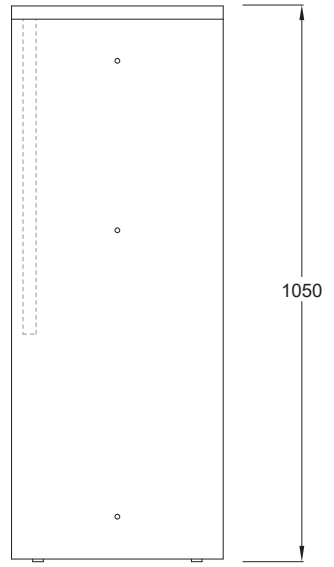
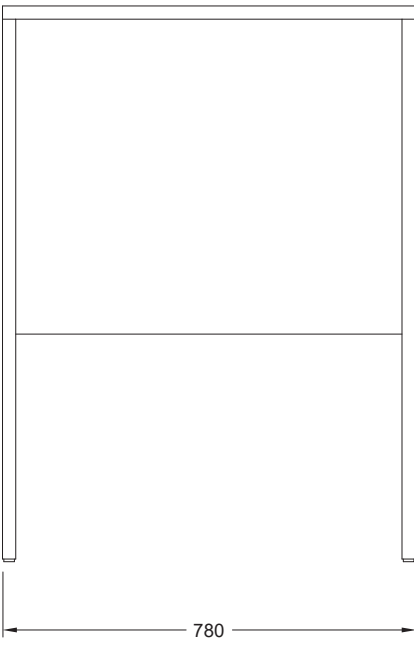
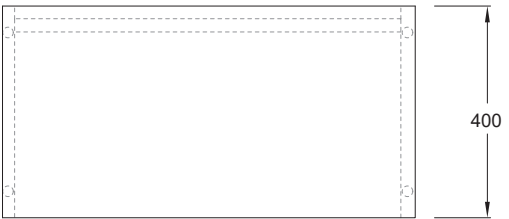

# PUFFALO MODULAR DESKING (HI)

PF-BDK[HI].78x60

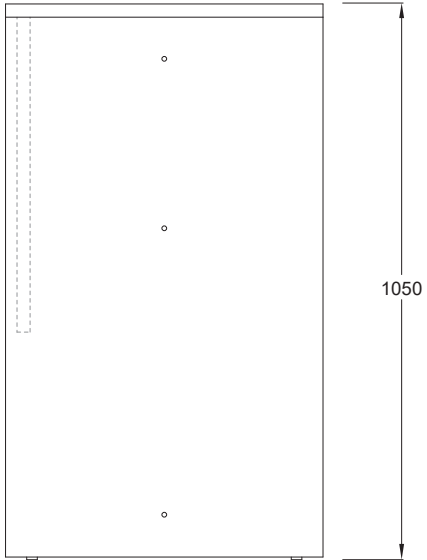
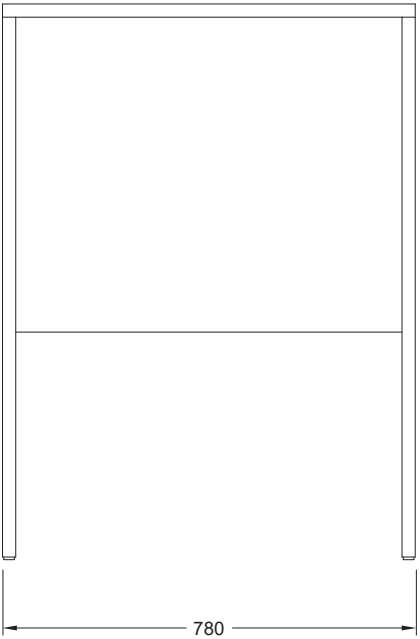
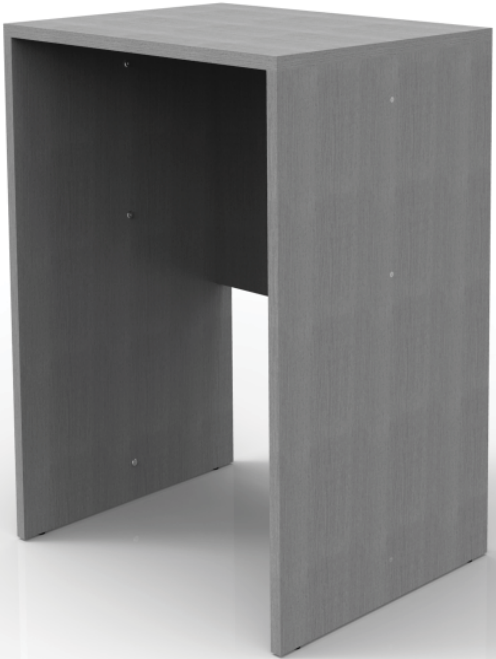

# PUFFALO MODULAR DESKING (HI)

PF-BDK[HI].130X40

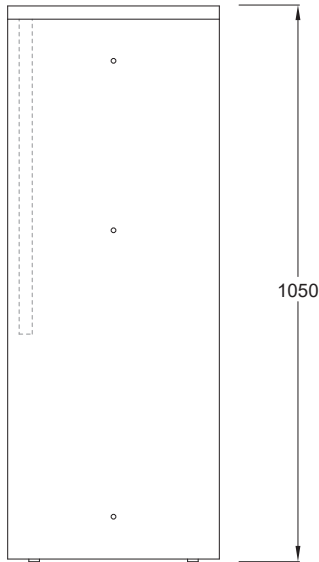
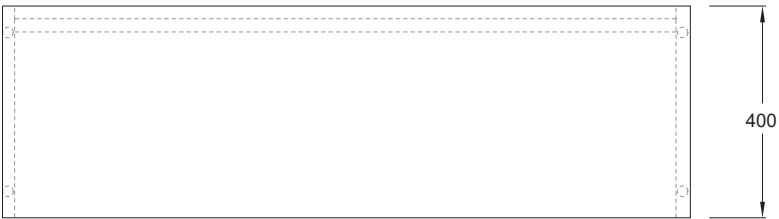

# PUFFALO MODULAR DESKING (HI)

PF-BDK[HI].130X60

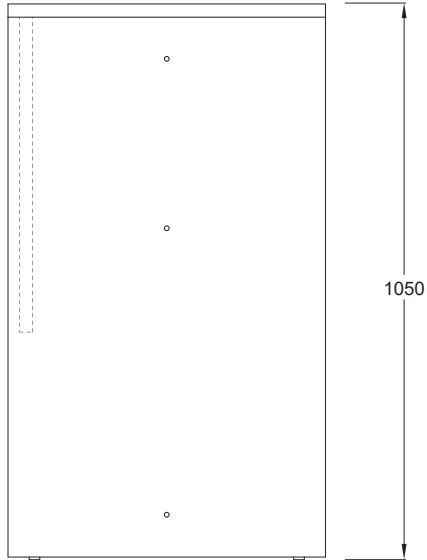
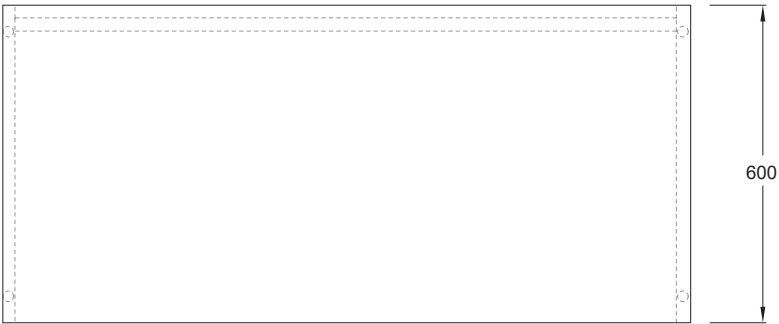

# PUFFALO MODULAR DESKING (HI)

PF-BDK[HI].143X40

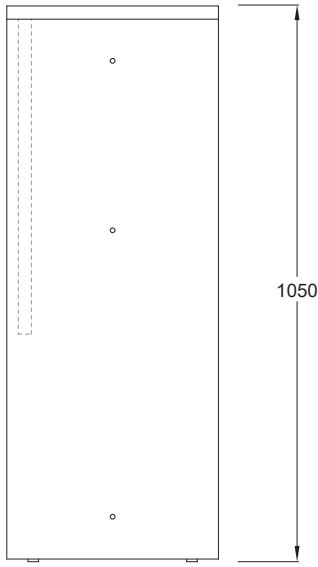
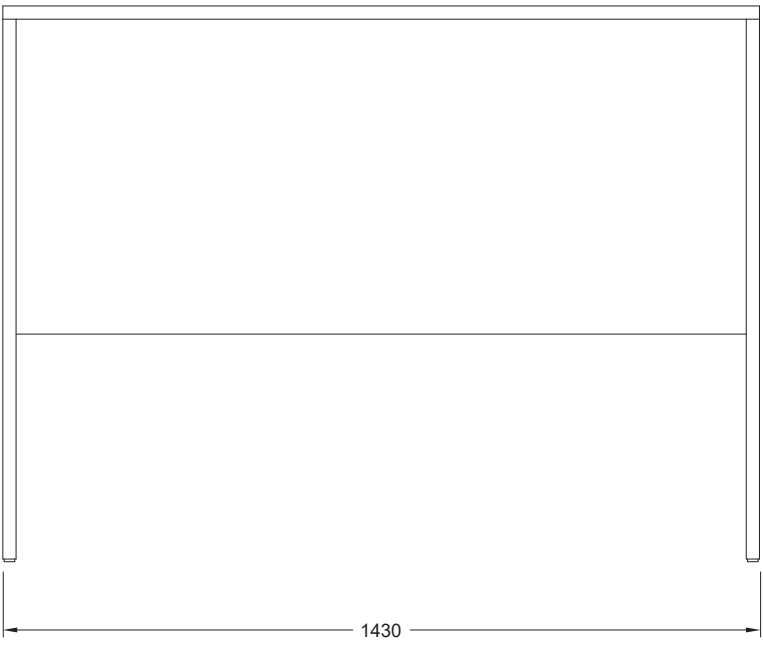
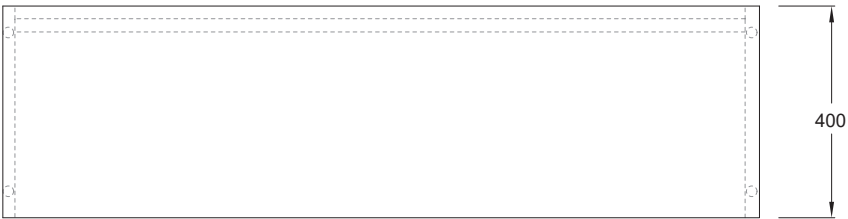

# PUFFALO MODULAR DESKING (HI)

PF-BDK[HI].143X60

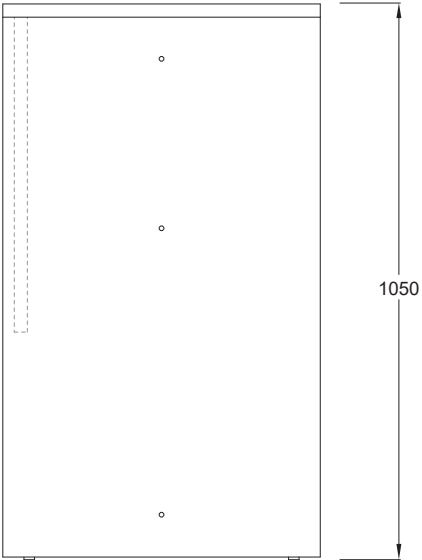



# PUFFALO MODULAR DESKING (HI)

PF-BDK[HI].195X40

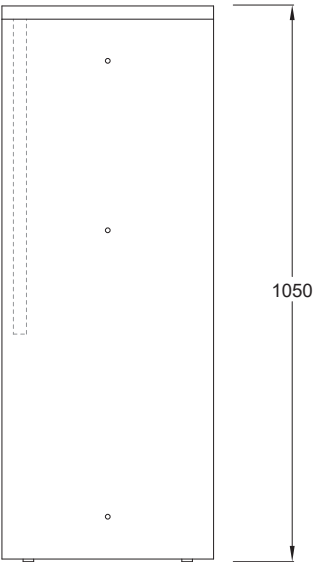
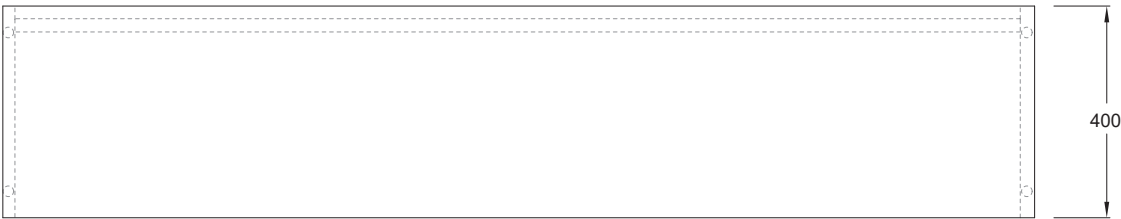

# PUFFALO MODULAR DESKING (HI)

PF-BDK[HI].195X60

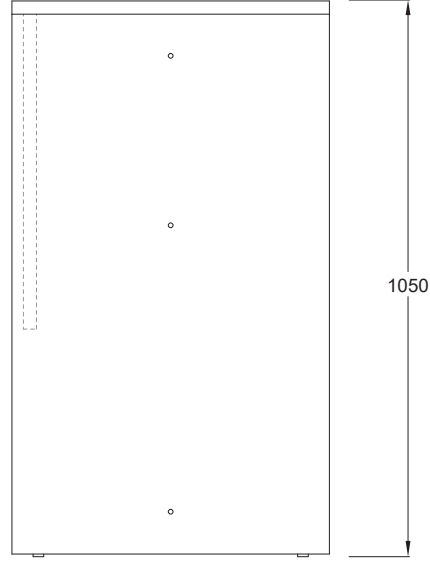

# PUFFALO MODULAR DESKING (HI)

PF-BDK[HI].208X40

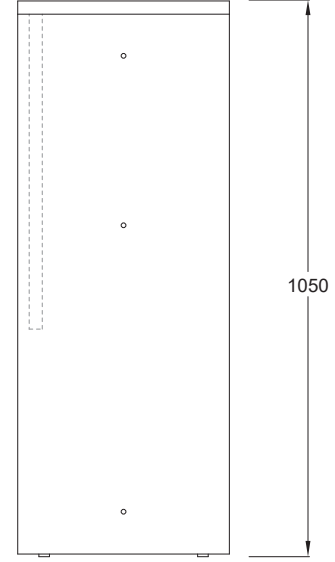
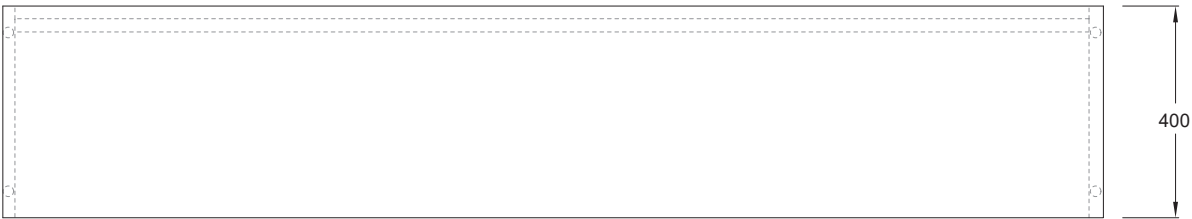

# PUFFALO MODULAR DESKING (HI)

PF-BDK[HI].208X60

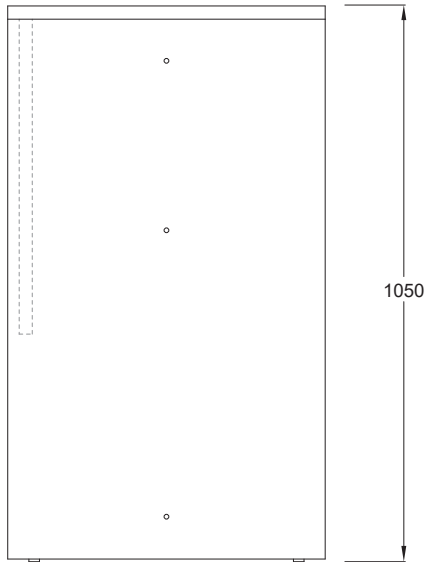

# PUFFALO MODULAR DESKING (HI)

PF-BDK[HI]\_IN\_R150X40

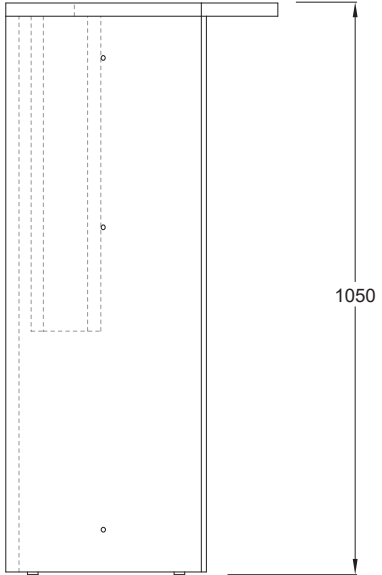
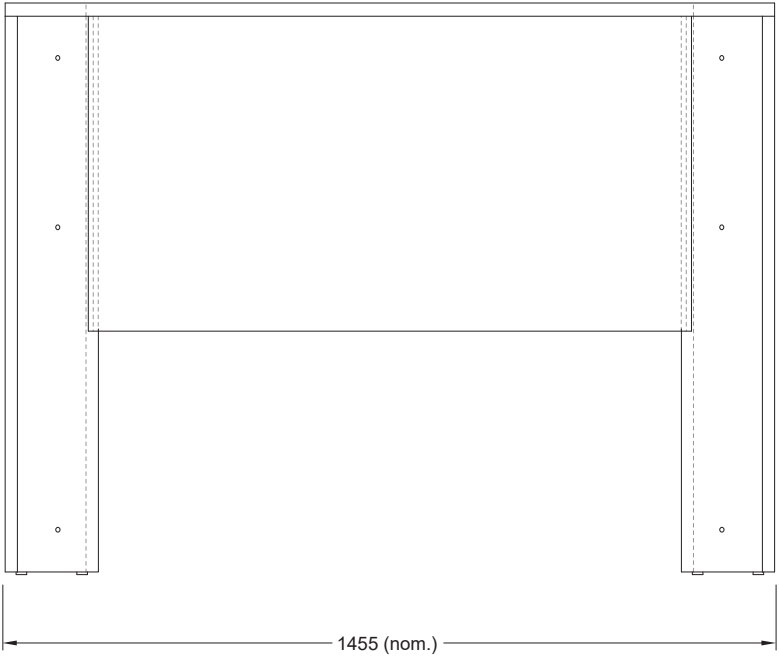
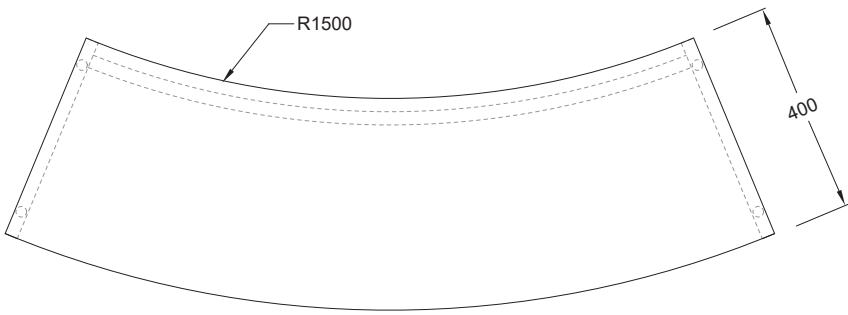

# PUFFALO MODULAR DESKING (HI)

PF-BDK[HI]\_IN\_R150X60

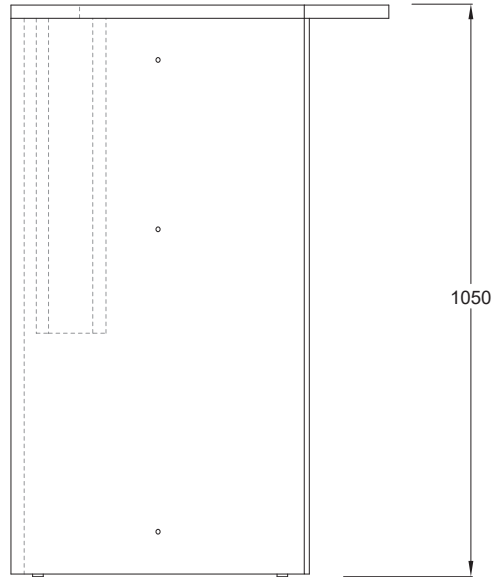
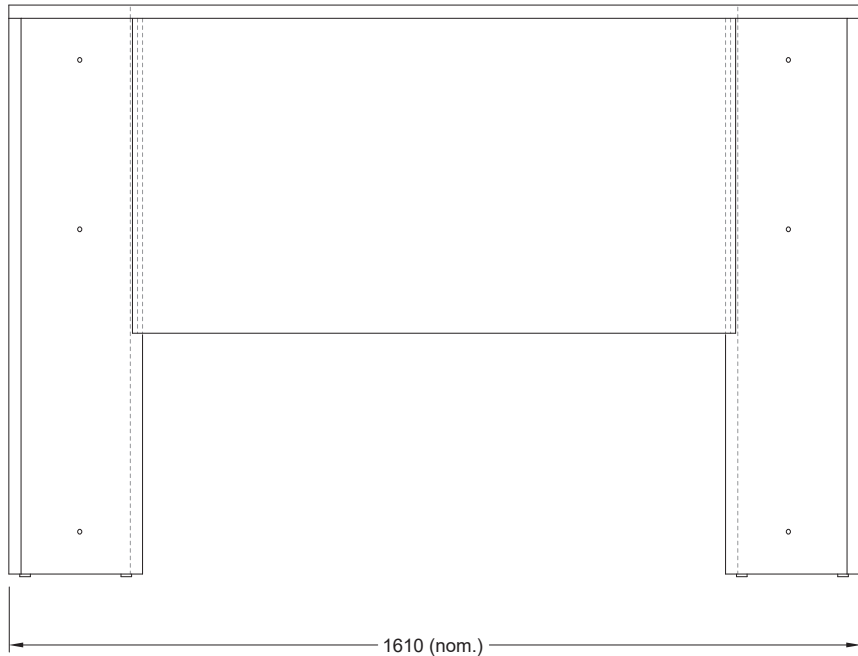
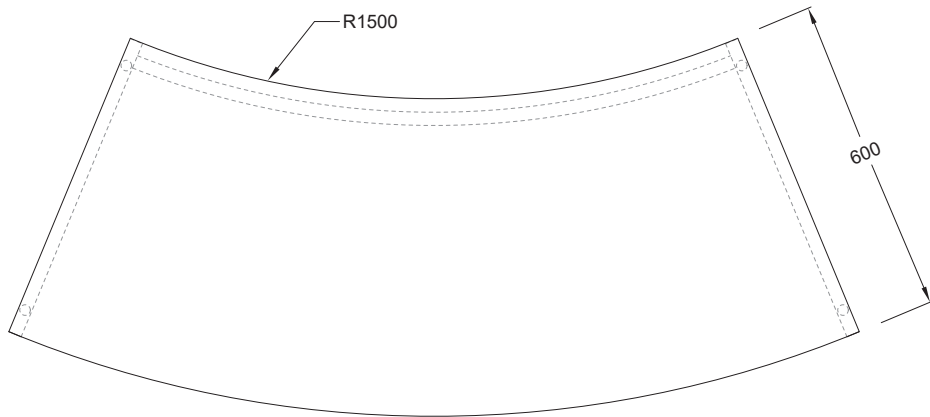

# PUFFALO MODULAR DESKING (HI)

PF-BDK[HI]\_OUT\_R150\_8th FILL(40)

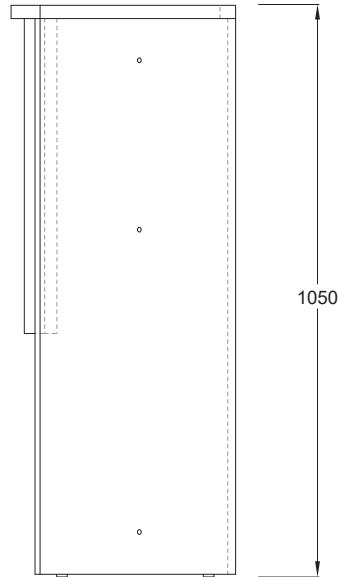
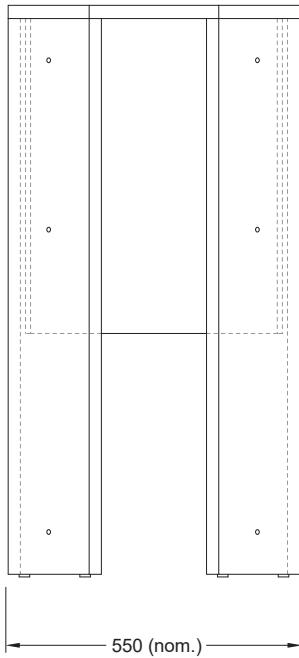
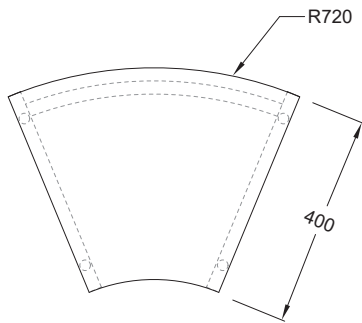

# PUFFALO MODULAR DESKING (HI)

PF-BDK[HI]\_OUT\_R150\_8th FILL(60)

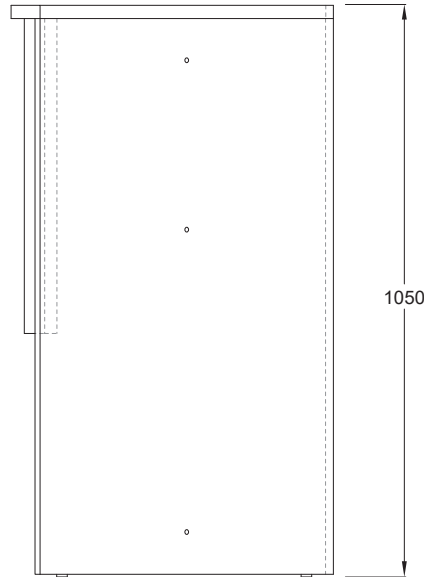
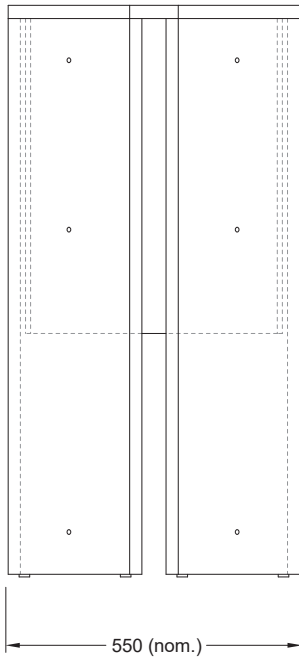
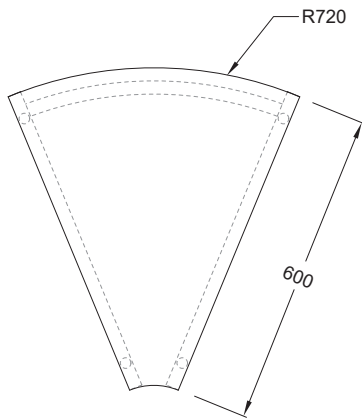



# PUFFALO MODULAR DESKING (HI)

PF-BDK[HI]\_OUT\_R150\_QTR FILL(40)

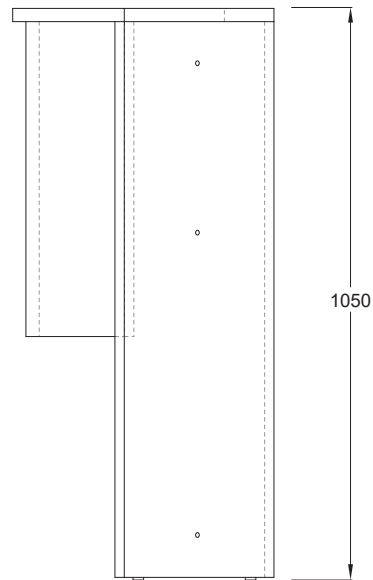
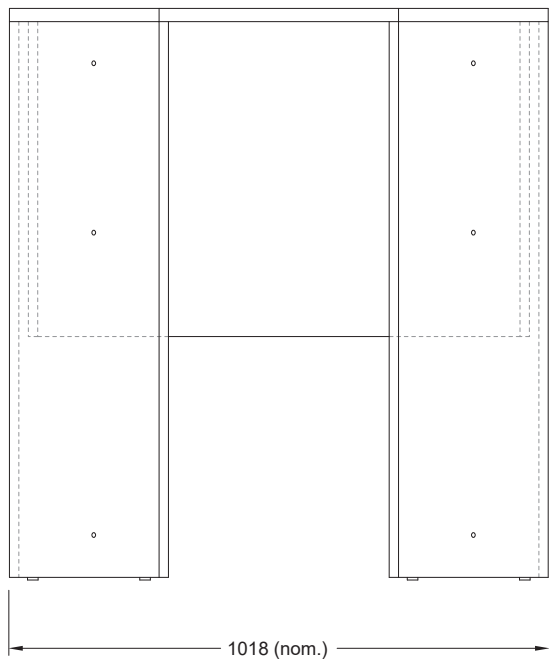
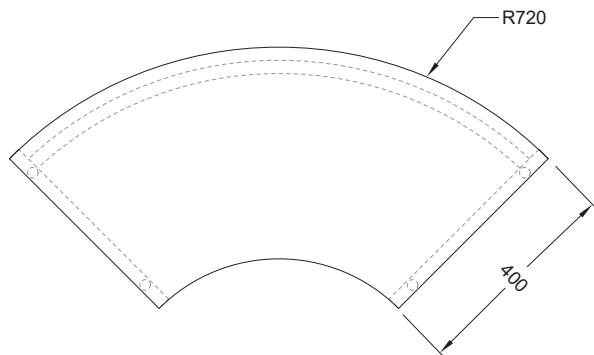

# PUFFALO MODULAR DESKING (HI)

PF-BDK[HI]\_OUT\_R150\_QTR FILL(60)

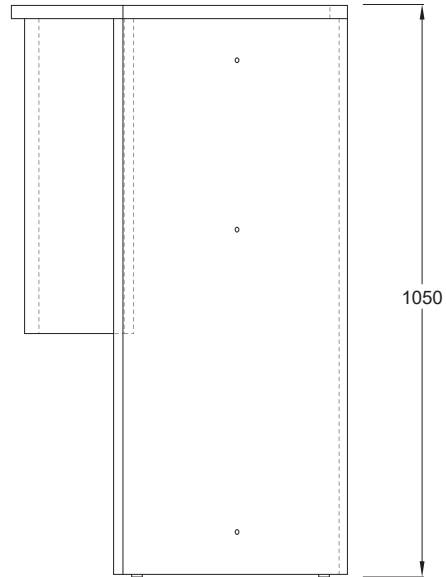
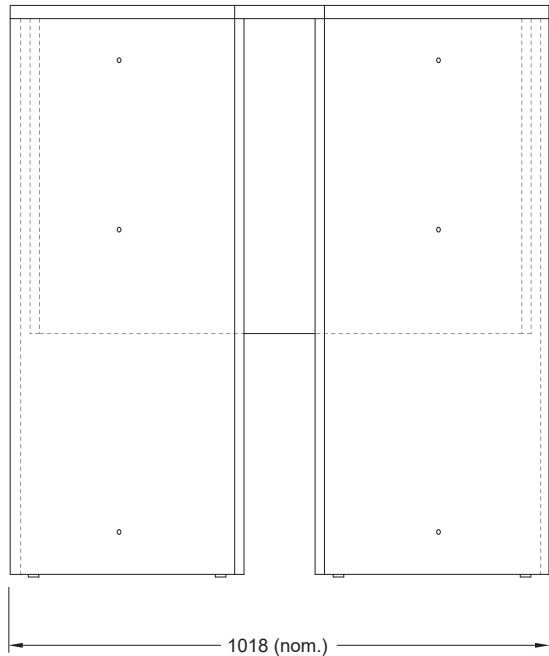
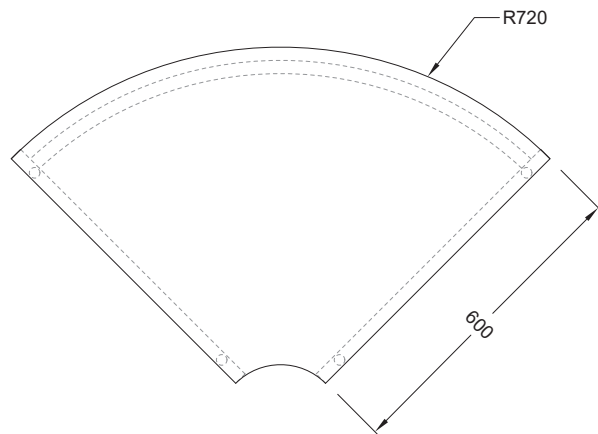

# PUFFALO MODULAR DESKING (HI)

PF-BDK[HI]\_OUT\_R150\_QTR FILL(40-60)

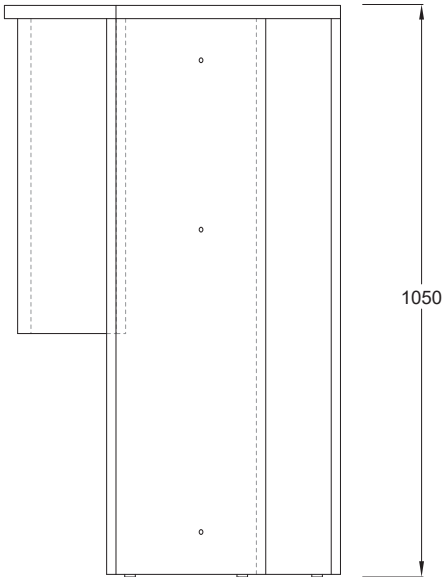
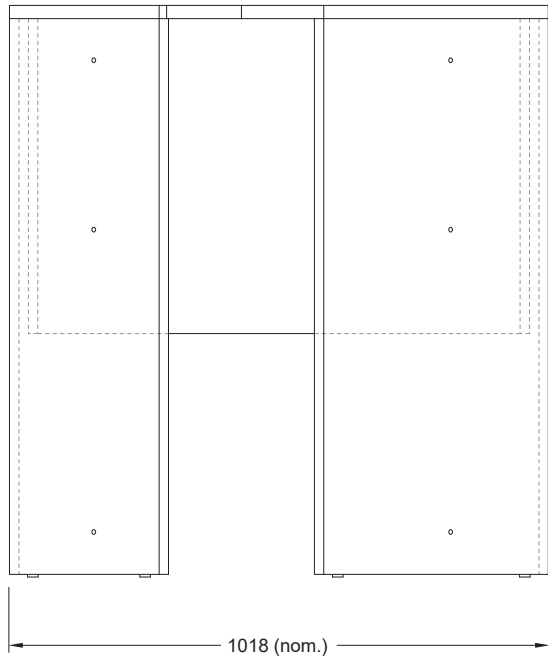
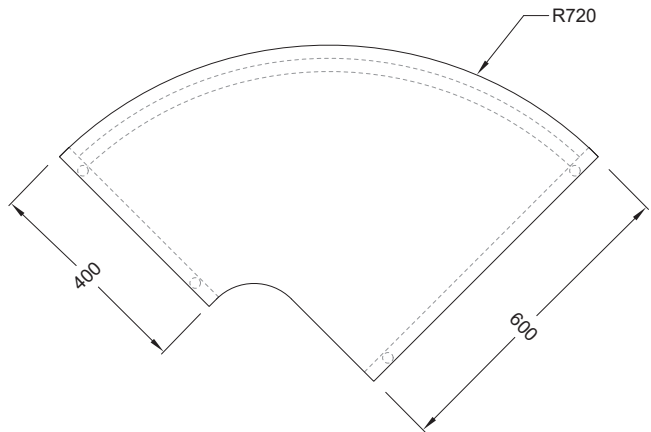

# PUFFALO MODULAR DESKING (HI)

PF-BDK[HI]\_OUT\_R150\_QTR FILL(60-40)

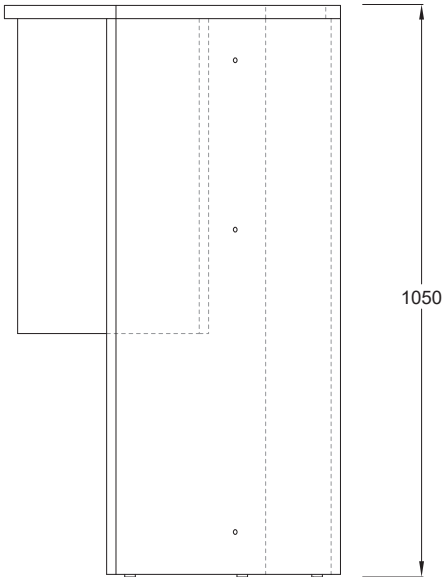
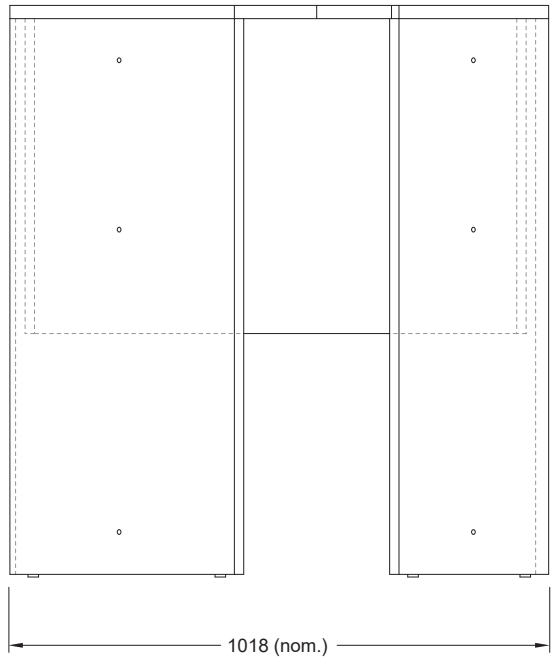
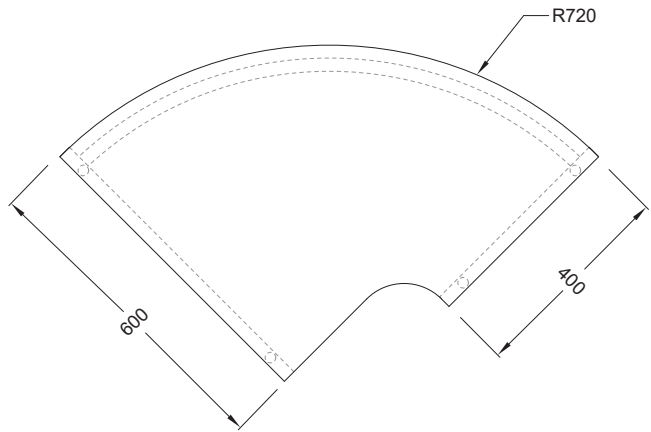

# PUFFALO MODULAR DESKING (HI)

PF-BDK[HI]\_IN-QUAD FILL(40)

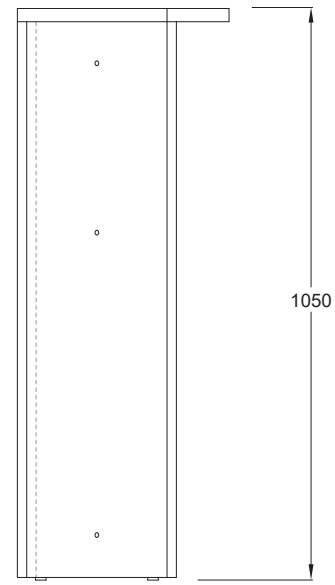
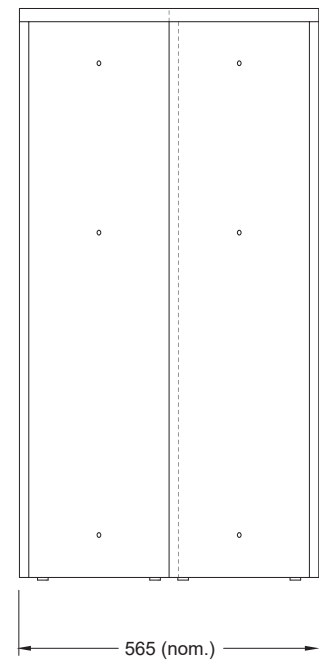
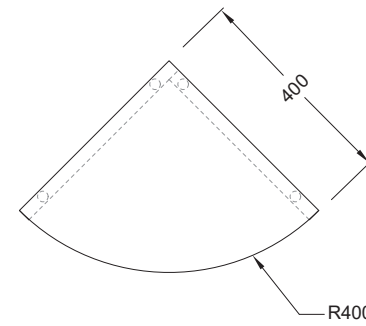

# PUFFALO MODULAR DESKING (HI)

PF-BDK[HI]\_IN-QUAD FILL(60)

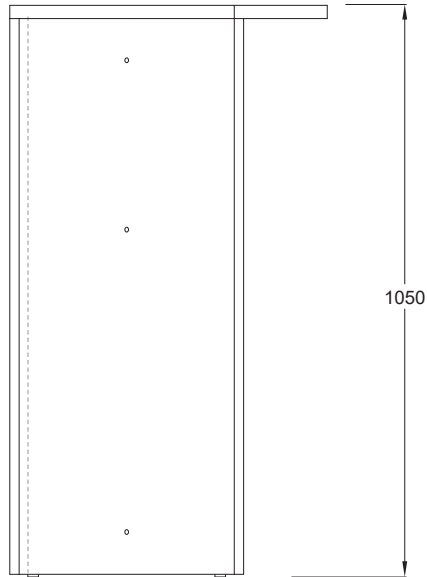
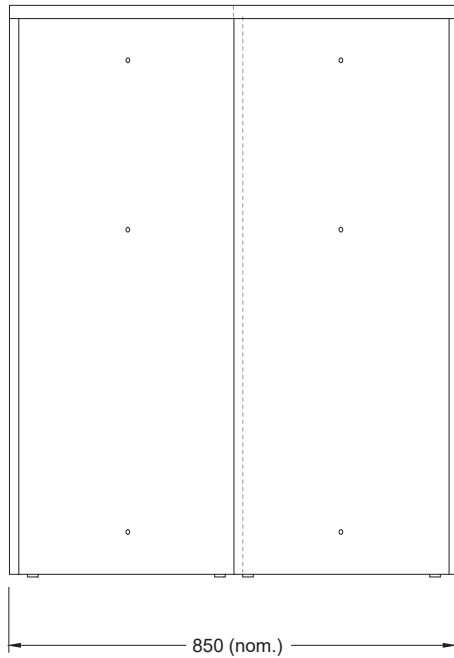
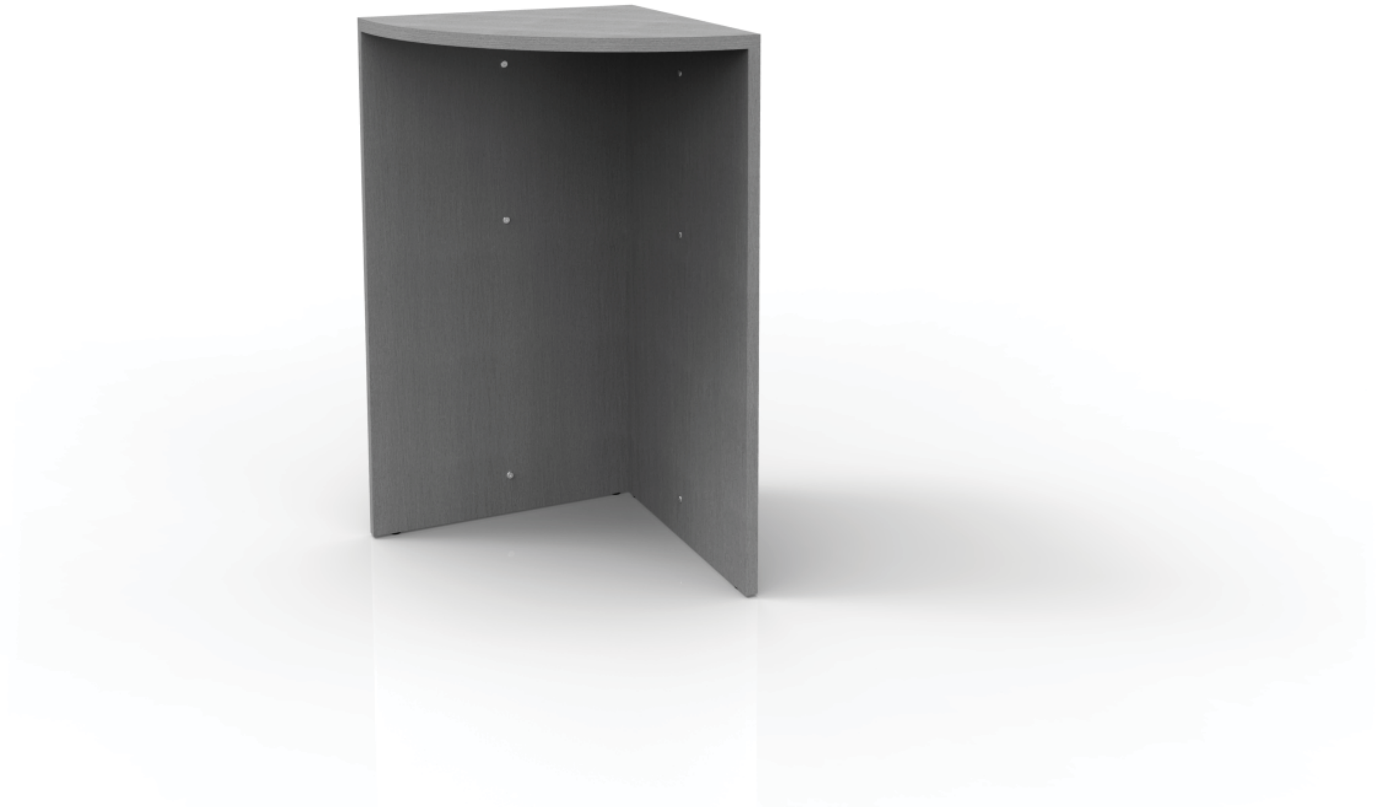
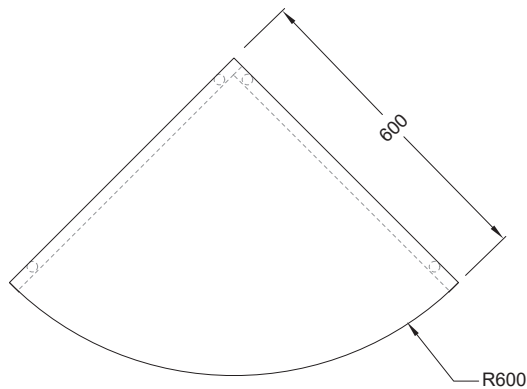

# PUFFALO MODULAR DESKING (HI)

PF-BDK[HI]\_IN-QUAD FILL(40-60)

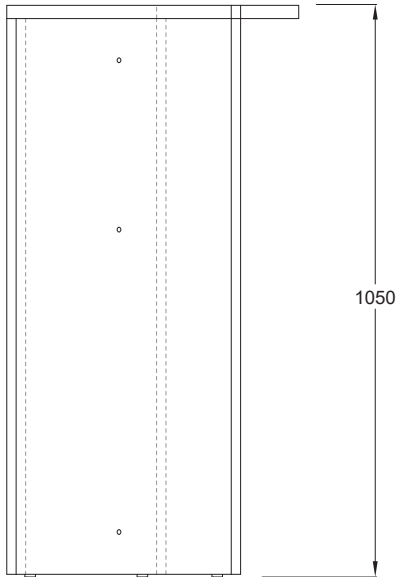
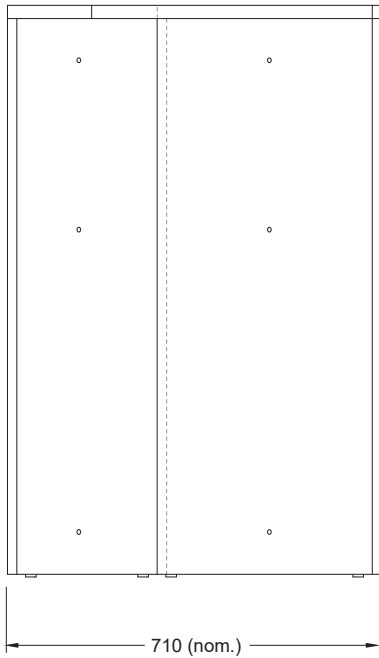
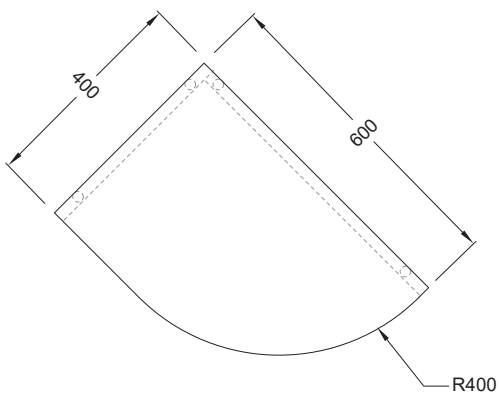

# PUFFALO MODULAR DESKING (HI)

PF-BDK[HI]\_IN-QUAD FILL(60-40)

