

ASNII-203

User Manual



Content

A. Components	1
<hr/>	
B. H/W Parts	2
i. Both Sides	3
ii. Settings	4
<hr/>	
C. System Settings	
i. Date & Time	5
ii. Wi-Fi	7
iii. Screen Timeout	8
iv. Language	9
<hr/>	
D. Application	
i. Settings	10
ii. Full Diagnosis	
CRM	11
Pore	12
Thickness	14
Cuticle	15
Result	17
Send Result	
i. Email	18
ii. Mirroring	19
<hr/>	
E. Troubleshooting & FAQ	21
<hr/>	
F. Warranty	23

Components

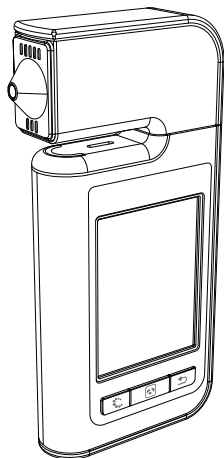

Main body with hair lens(ASN II 203)

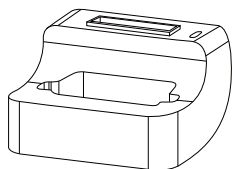

Cradle



Battery (2EA)

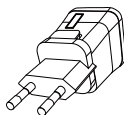

Charger



USB cable



Pen (2EA)

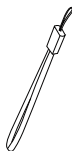

Hand strap



Cleaning cloth



Leather case



Manual

H/W Parts

Both Sides

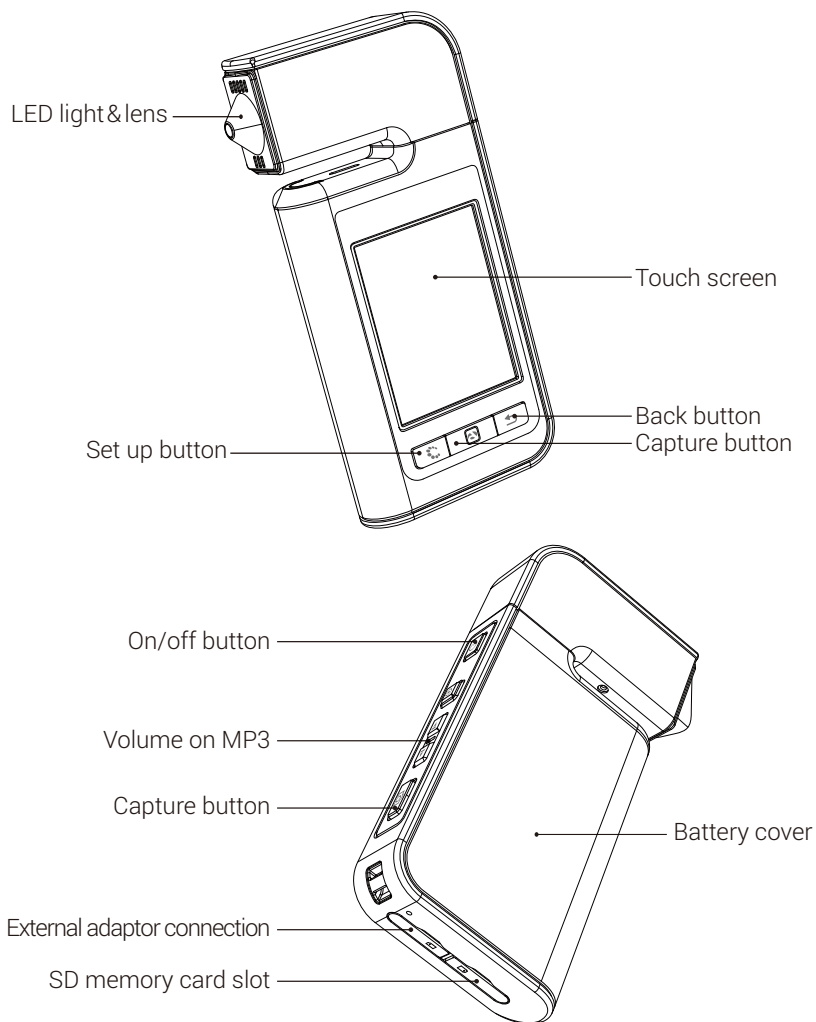

H/W Parts

Settings

Insert the battery

- 1 Open the battery cover by pushing it left to right way with thumbs.
- 2 Insert the battery and gently press the battery into place.
- 3 Close the cover.

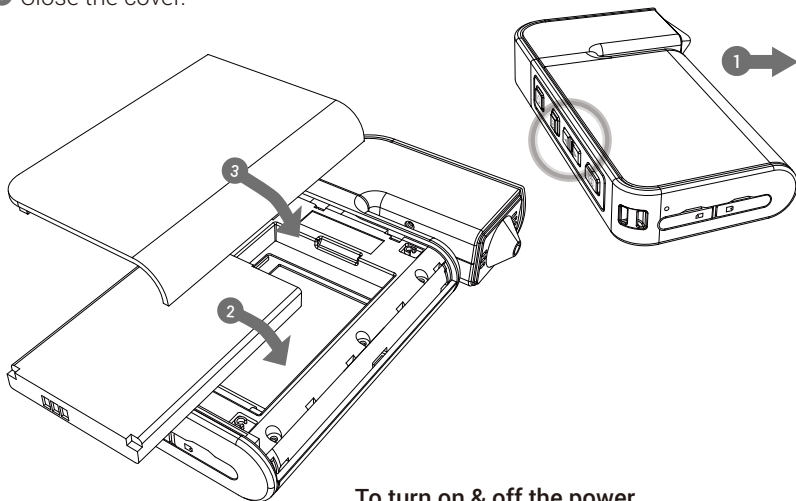

To turn on & off the power

- 1 Press and hold "power" button.
- 2 Then "Indicate LED" will be twinkled and turned on white.

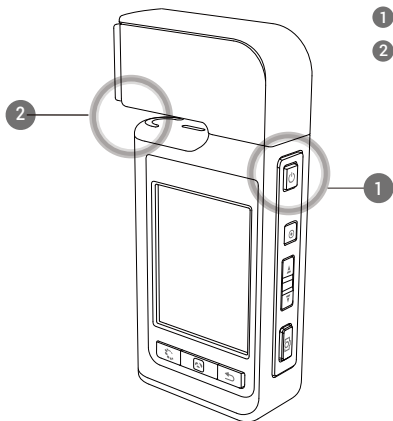

H/W Parts

Settings

**Charger can be used for American type & European type.
The default is European type .**

- ① Push the plug up.

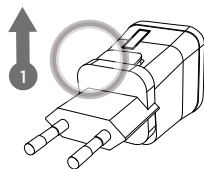

- ② Then 220V European type is disassembled and you can see the 110V-220V American type inside of the charger.

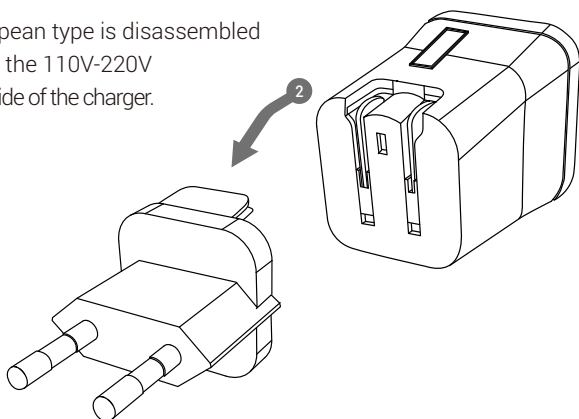

- ③ Choose the one you want to use and connect USB cable in adaptor.

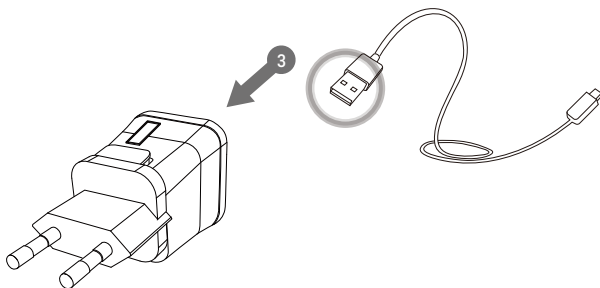

System Settings

Date & Time



1 Press button.

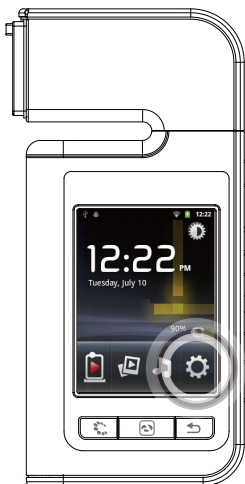

2 Touch button.

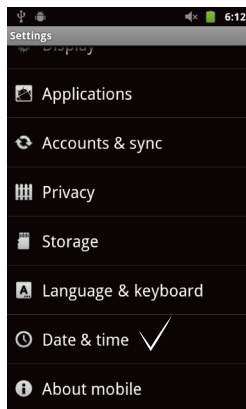

3 Touch "Date & time".

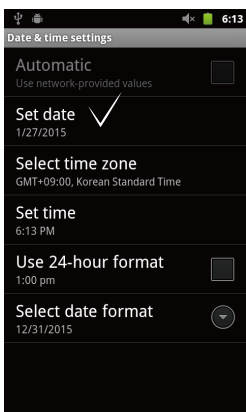

4 Touch "Set date".

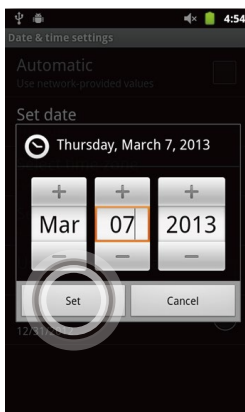

5 Change the date and touch "Set" button.

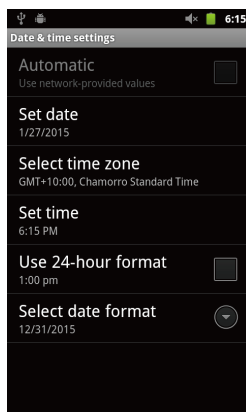

6 Please check the setting is correctly applied.

System Settings

Date & Time

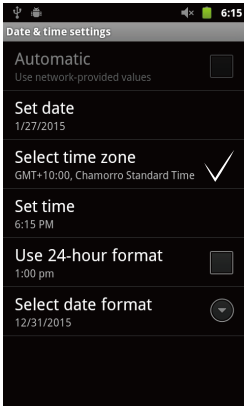

7 Touch "Select time zone" button.



8 Change into the current time zone .

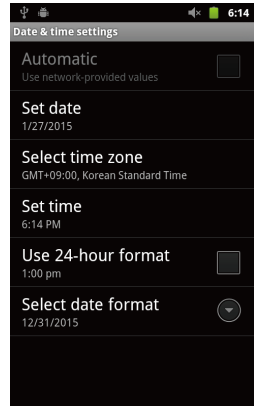

9 Please check the setting is correctly applied.

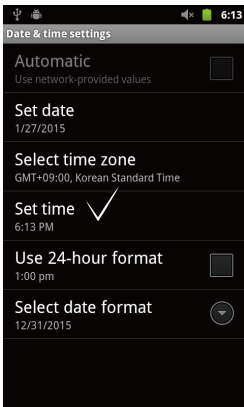

10 Touch "Set time".

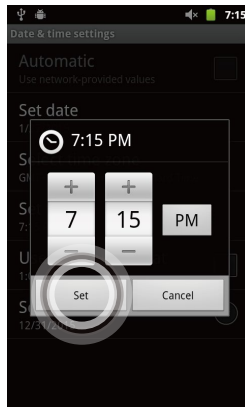

11 Change into the current time and touch "Set" button.

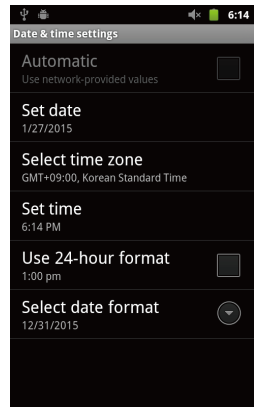

12 Please check the setting is correctly applied.

System Settings

Wi-Fi

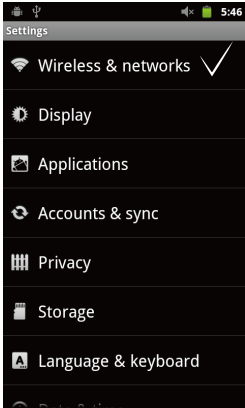

1 Touch "Wireless & networks".

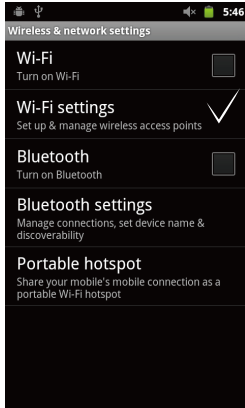

2 Touch "Wi-Fi settings".

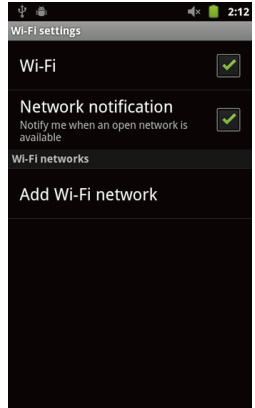

3 Check the square box.

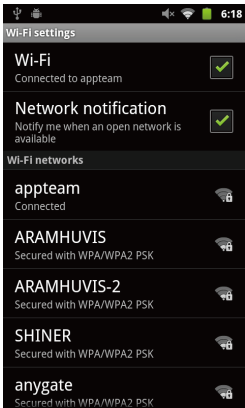

4 Wi-Fi list will be appeared.

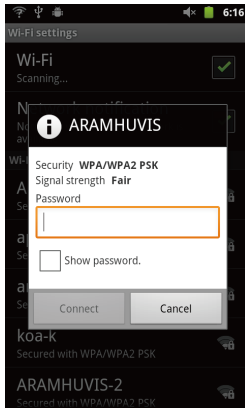

5 Among the lists, select the Wi-Fi connection you could use.

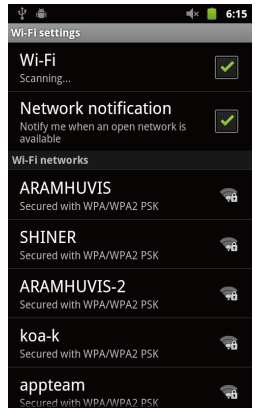

6 Wait until the device is connected to with Wi-Fi.

System Settings

Wi-Fi



- 7 Once the device is connected to Wi-Fi, you can see the wi-fi signal as left image.

Wi-Fi Usage

- E - mail
In order to send the analysis data.
- Software update
In order to update the software version.

Screen Timeout

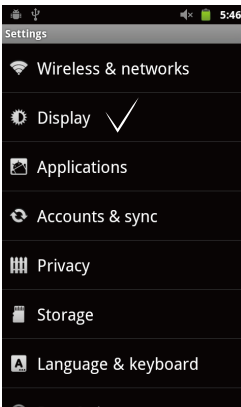

- 1 Touch "Display".

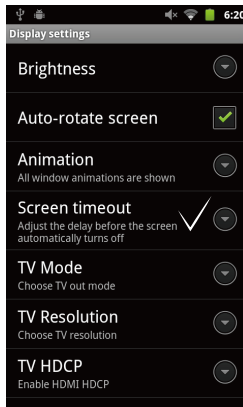

- 2 Touch "Screen timeout".

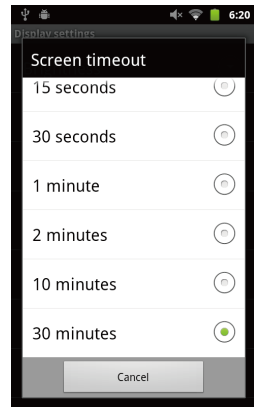

- 3 Touch the time you want to set.

System Settings

Language

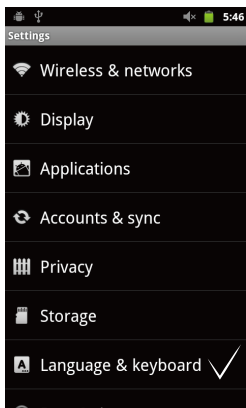

- 1 Touch "Language & keyboard".



- 2 Touch "Select language".

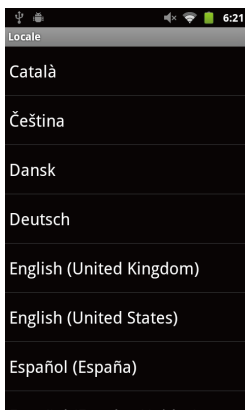

- 3 Among the lists, touch your language.

Application

Settings

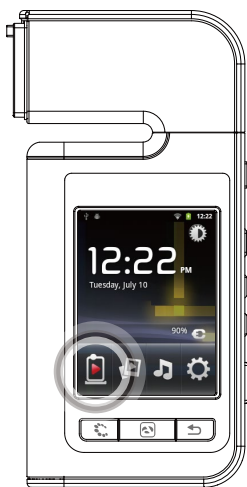

1 Touch  button.



2 Touch  button.



3 Touch "Setup" button.

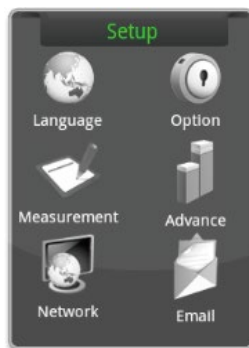

4 Language, version, email setting is available.

Application

CRM



1 Touch "Full" button.

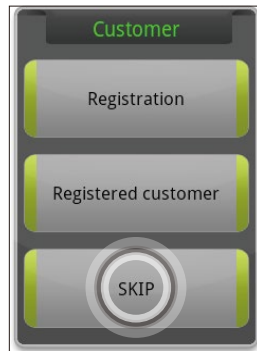

2 Touch "SKIP".



3 Input the information.

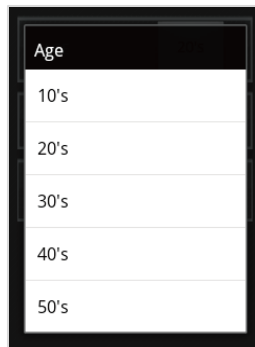

4 Enter Age group and Gender of customer.

Application

Pore

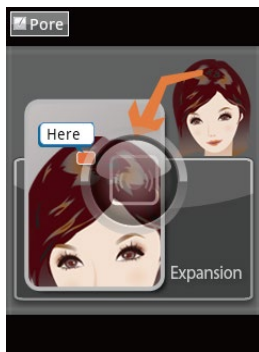

1 Touch  to activate camera.

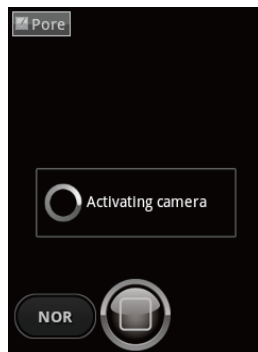

2 Wait until the camera activates and take image.



3 Adjust the brightness by touching.

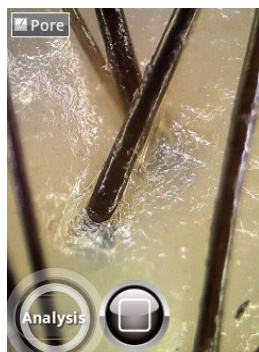
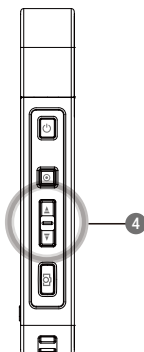

5 Touch "Analysis".

Application

Pore

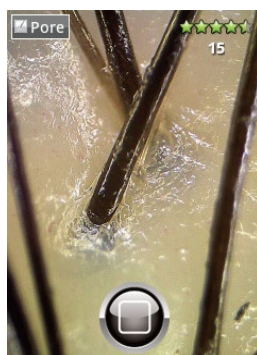
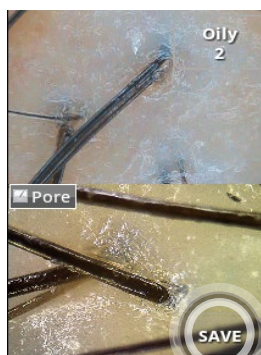
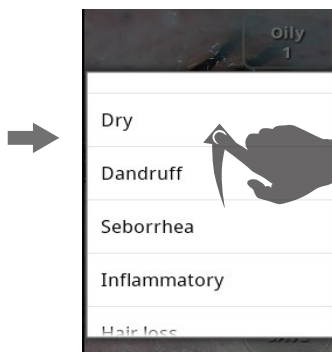

Application

Thickness

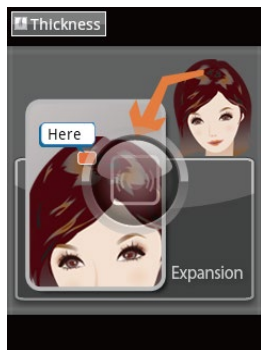

- 1 Touch  to activate camera. 2 Wait until the camera activates and take image.

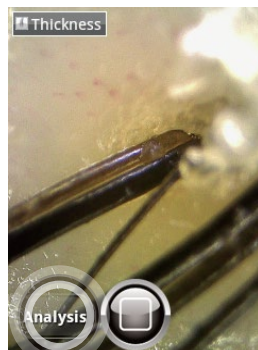
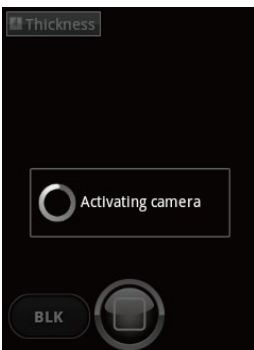

- 3 Touch "Analysis".

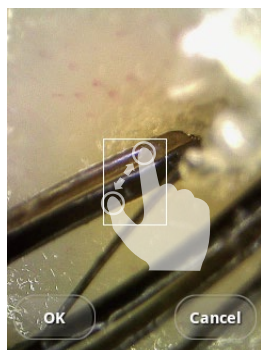

- 4 Choose the area by moving the white box.

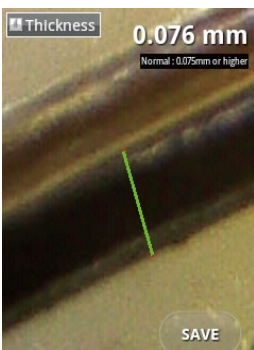

- 5 Measure the length of hair by using touch pen. Touch "SAVE".

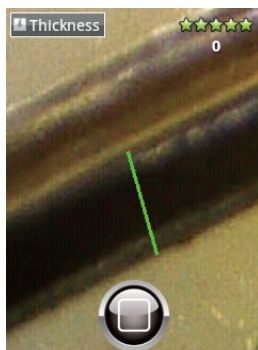

- 6 Show the diagnosed result by number and level on the capture page.

Application

Cuticle

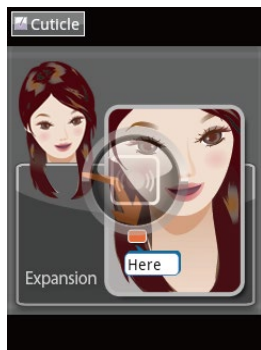

1 Touch  to activate camera.

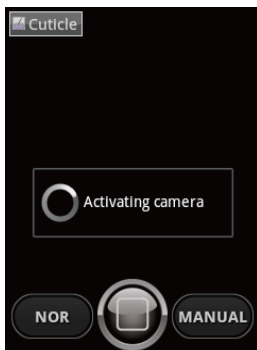

2 Choose the mode "MANUAL" or "Auto."



3 Adjust the brightness by touching.

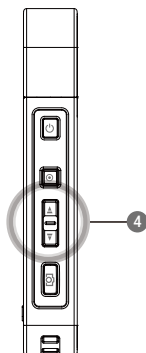

5 Touch "Analysis".

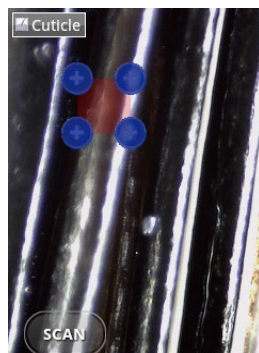

6 Choose the range you want to analyze.

Application

Cuticle

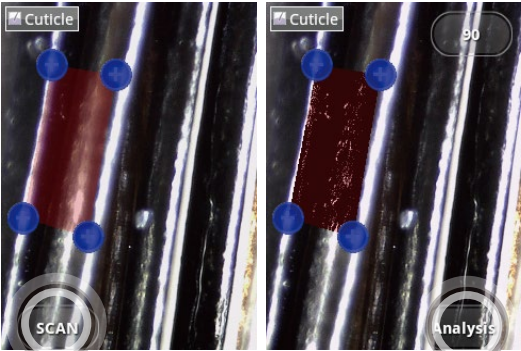

7 Touch "SCAN".

8 Show the diagnosed result by number on the capture page. Touch "Analysis".

9 Sample image

Good 1

Customer's image.

SAVE



Good

Slightly damaged

Damaged

Extremely damaged

Trchoclasia&Split

Extremely damaged 5

Cuticle

SAVE

2

10 When drag the screen, select the 'types'.

11 Choose types of sample which is similar with your image. Touch "SAVE".

12 Show the diagnosed result by number and level on the capture page.

Application

Result - Hair Type

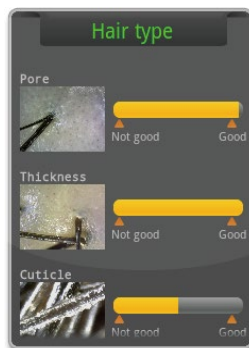

The result will be shown by bar type.

Result - Analysis Result



1 Touch ?

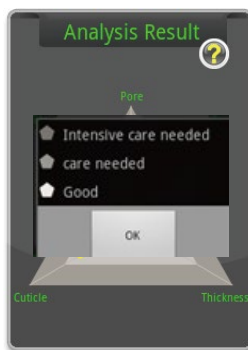

2 Check the instruction.

Application

Send Result - Email



- ① Only available when the device is connected to internet.

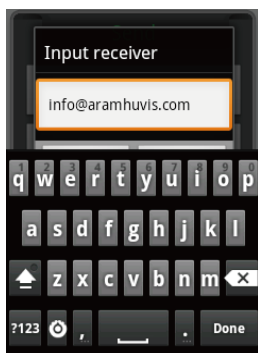

- ② Enter the customer's email address.



- ③ Touch "OK" button.

Application

Send Result - Mirroring

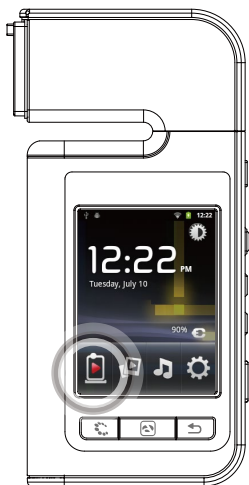

1 Touch  button.



2 Touch  button.



3 Touch "Setup" button.



4 Touch "Option" button.

Application

Send Result - Mirroring



5 Touch "Mirroring" button.



6 It is able to connect to "Android" & "iOS" system when AP success is shown up on the screen.



7 With your mobile device, capture QR code. Then program will be installed.



8 Open the "aramVIEWER" app after installing.



9 In your mobile device go to Wi-Fi setting. Then find "ARAMHUVIS" code and connect it.

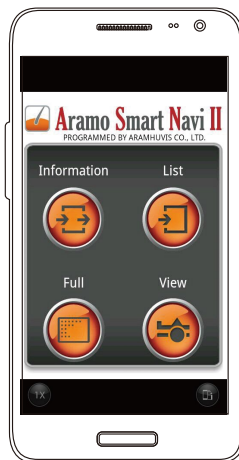

10 Mirroring system is started.

Troubleshooting & FAQ

1 I cannot turn on the device.

Connect and charge the device (or the battery) using the adaptor provided the supplier. (The battery charging indicator will be shown on the system main page.)

2 I cannot power on the device even the battery is still full.

The battery might be dislocated on the device. Please separate the battery from the device and put it on, and then power on again.

3 The battery is not charging very well.

Separate the battery from the device and put it on again.

Check the connection among a device, a battery and a charger.

A battery cannot be charged if there is an alien substance on the charging port.

In this case, please use the device after cleaning the charging port of the device or check whether the sticker is attached on charging port.

4 The using time of the battery is different from the manual.

The battery using time will be shorten if you put the charged battery in a low or high temperature.

The battery using time varies in service type, using environment, using period of the battery.

The battery is consumed without using the device, and the battery using time will be shorten if you use additional functions of the device.

5 The device turns on but the diagnosis doesn't work.

Check the smart card is correctly inserted (SD card slot on the button of the device.)

6 There are dust on the device.

Clean the dust by using a smooth fabric. Do not use benzene, alcohol, and a synthetic detergent.

7 The screen is frozen and the keys not working when using the device.

Separate the battery from the device and put it on again.

If the device is still not working please contact to the customer service center.

8 A "force close" message appears on the screen.

The repetition of commands can trigger a bug. Sometimes there may be a brief delay before the command is completed. Do not repeat/multiply the tasks as the device will no longer be able to follow them.

9 I cannot connect to Wi-Fi.

Check the connection status on setting page.

Try to connect to another Wi-Fi.

Bluetooth : check the pairing status and try to re-pair the device with host device.

Troubleshooting & FAQ

10 The touchscreen doesn't react to my finger commands.

Before using for the first time remove the protective plastic film.

11 I cannot connect to Blue-tooth.

Make sure to use the Bluetooth hosting devices that have Bluetooth certified with the logo. You may need an external Bluetooth dongle for those devices that do not have Bluetooth feature.

bring the device to closer with the Bluetooth hosting device.

Try to re-pair the device with host device.

The password of pairing is "0"(number).

* Blue-tooth function is not allowed to use in IOS device without APPLE'S official permission.

12 The screen was turned off.

Press the on/off button to turn on the screen.

The device has a power save function that turn the screen off after 1minute.

For the setting, please refer to Page 8.

13 I can see the black screen only during measurement.

Check the LED light inside lens on the head part when you try to measurement.

If you cannot see the light, please contact the customer service via email or phone call.

14 The image is not clear.

Tap the screen while capturing focus.

15 I cannot update the diagnosis application.

Check the network connection. The update process can be done after connecting to Wi-Fi.

Warranty

- ① The product undergoes strict quality management and inspection process before production and introduction to market.
- ② In case of functional or operational defect occurs under normal condition of use within 10 days after purchase, we will repair it for free or replace in new product.
- ③ When this product goes out under the normal use, we will repair it free of charge under warranty.
- ④ Please keep the warranty card when you ask for repair service.
- ⑤ Customer needs to pay repair charge after warranty runs out.
- ⑥ For this product, warranty period is 14 months from the Invoice date.
- ⑦ Cost
 - Within warranty : Sending delivery(Buyer), repair cost and returning delivery(Aram)
 - If the product is broken by user's fault, repair cost could be charged.
 - After warranty : Sending delivery and repair cost(Buyer), returning delivery(Aram)
- ⑧ How to send :
 - As sending a present from person to person by EMS or FEDEX.
 - (Do not write the company name)
 - Total value should be under US99\$.(Write non-commercial value)

Warranty

Service request form			
Date of purchase	/	/	Company
Contact Person			
Address :			
Tel :			
Product name, serial No :			
Problems :			

Shipping address:

801-ho , 560 Dunchon-daero, Jungwon-gu Seongnam-si Gyeonggi-do 13230 KOREA.

E-mail : support@aramhuvis.com

Tel: +82 70 4687 1712 / Fax : +82 31 732 6330

Memo
