

# ASM

## 300

User Manual



# Contents

<b>Components</b>	3
<hr/>	
<b>H/W Parts</b>	
Device Functions	4
Device Settings	5
<hr/>	
<b>System Settings</b>	
Date & Time	6
Wi-Fi	8
<hr/>	
<b>Application</b>	
i . Application Settings	9
ii . Customer	10
iii. Skin Analysis (ASM-100 Lens)	11
Moisture	12
Sebum	13
Pore	14
Melanin	15
Acne	16
Wrinkle	17
Sensitivity	18
Summary	19
iv. Hair Analysis (ASM-202 Lens)	20
Hair Loss Status	21
Scalp Status	22
Hair Density	23
Keratin of Scalp	24
Scalp Sensitivity	25
v . Hair Analysis (ASM-203 Lens)	26
Hair Thickness	27
Hair Pore Status	28
vi. Hair Analysis (ASM-204 Lens)	29
Cuticle Status	30
Summary	31
vii. Send Result -Email	32
viii. Mirroring	33
ix. View Mode	35
<hr/>	
<b>Warranty</b>	36

# Components

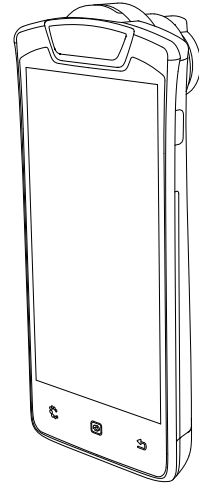

Main unit with skin lens (ASM 100)

Total 4 lenses



Skin lens (ASM 100)



Hair lens (ASM 202)

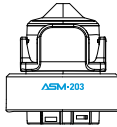

Hair lens (ASM 203)



Hair lens (ASM 204)

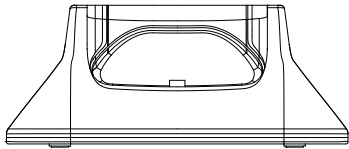

Cradle



Sebum paper (100ea)

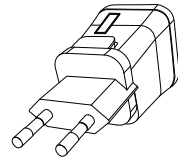

Charger

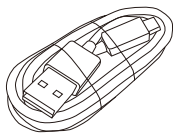

USB cable

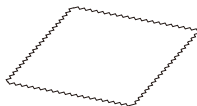

Cleaning cloth

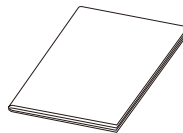

Manual

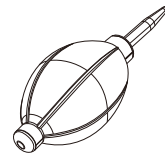

Air blower

# Device Functions

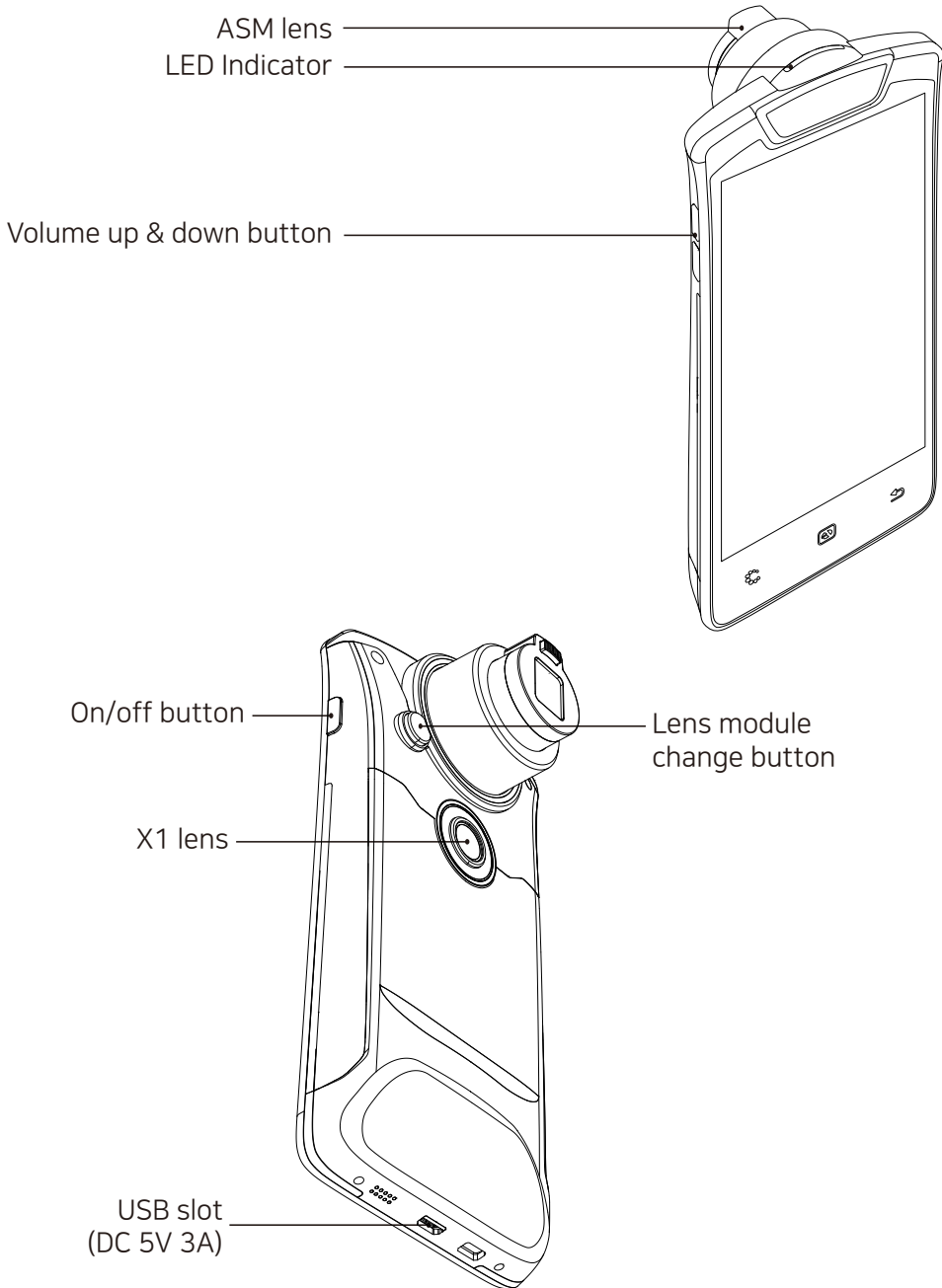

# Device Settings

To turn on & off the power

- ① Press and hold "Power" button.
- ② Then "LED Indicator" will be twinkle and turn to white.

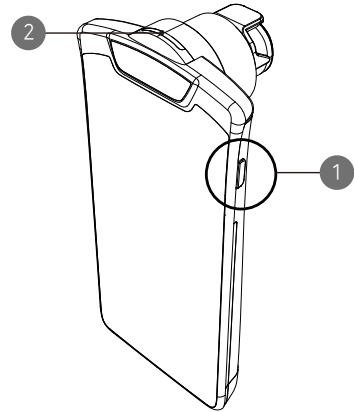

Charger can be used for American type & European type. The default is European type.

- ① Push the plug up.

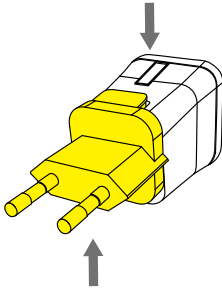

- ② Then European type is disassembled and you can see the American type inside of the charger.

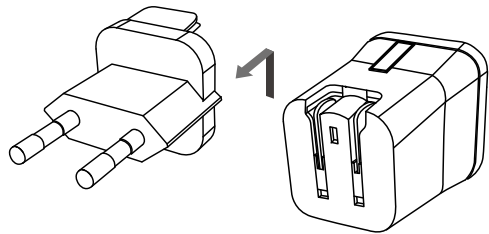

- ③ Choose the one you want to use and connect USB cable in adaptor.

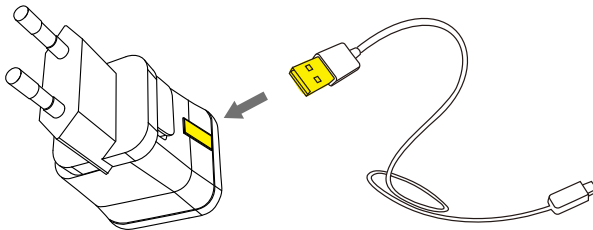

# Date & Time



Touch  button.

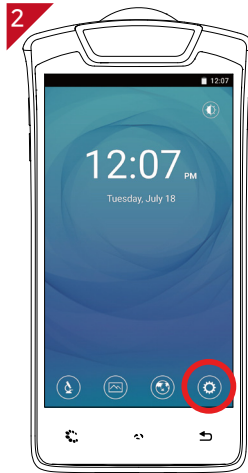

Touch  button.

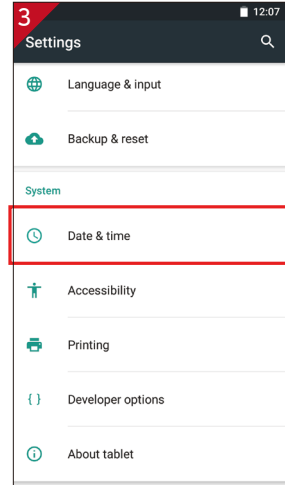

Go to "Date & time"

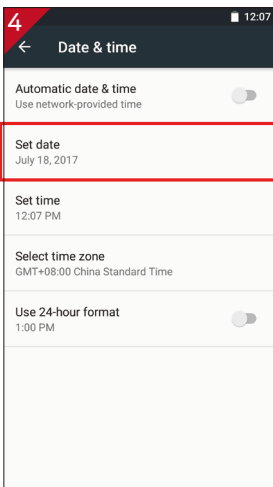

Go to "Set date".

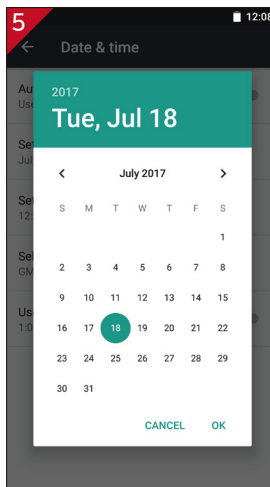

Select the date and touch "OK" button.

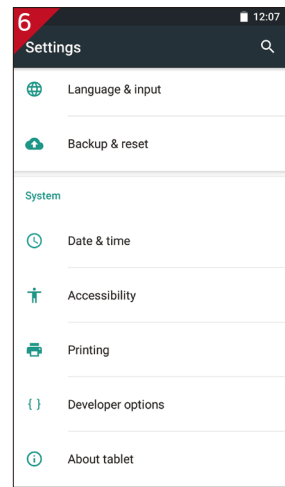

Check if the setting is correctly applied.

# Date & Time

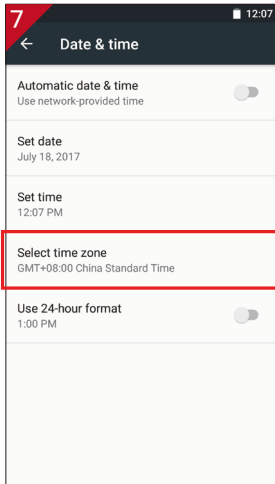

Touch "Select time zone"

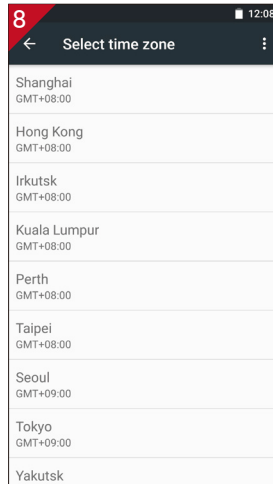

Select proper time zone.

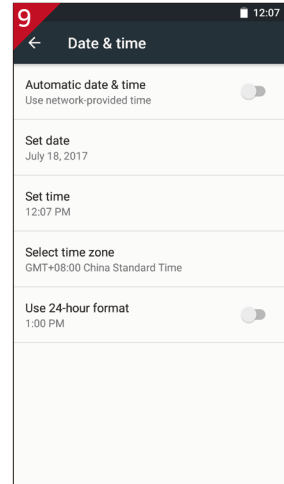

Check if the setting is correctly applied.

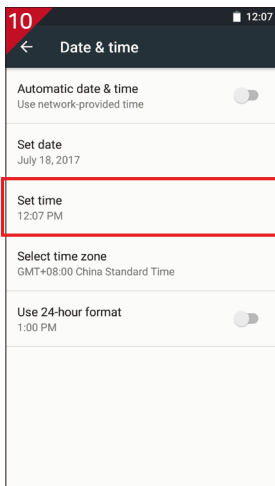

Touch "Set time".

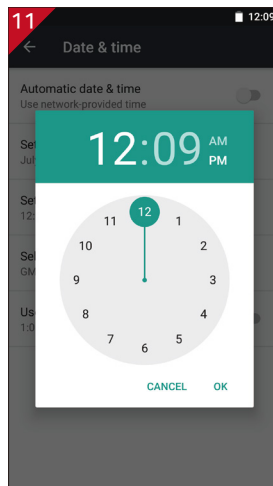

Change into the current time and touch "OK" button.

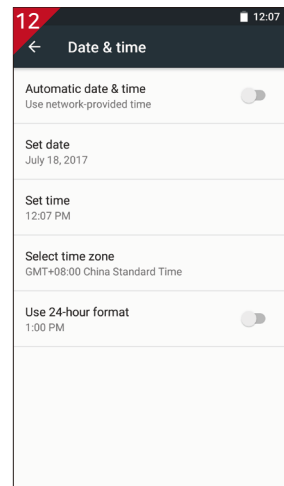

Check if the setting is correctly applied.

# Wi-Fi



Touch  button.

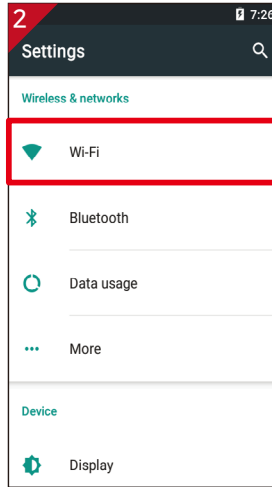

Touch "Wi-Fi".

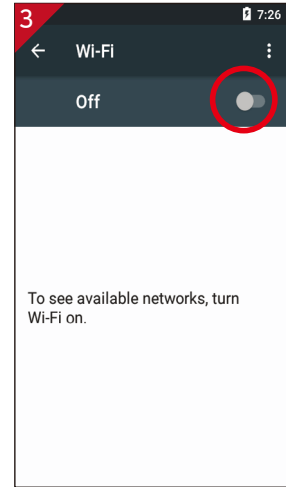

Turn on toggle switch.

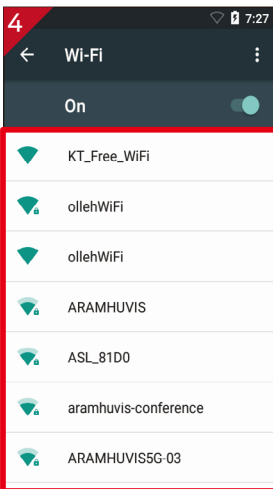

Wi-Fi list will appear.

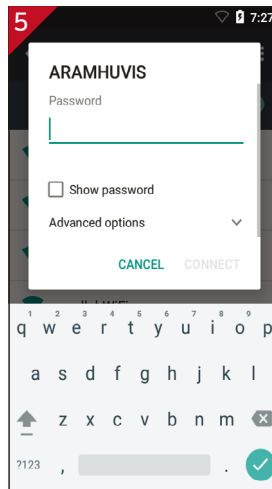

Among the lists, select the Wi-Fi connection you could use.

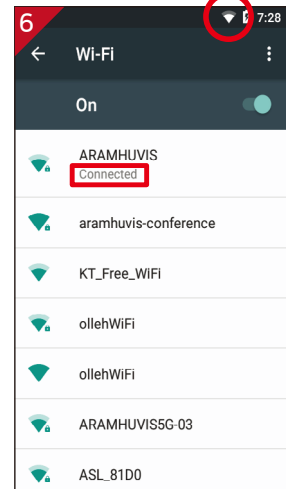

Wait until the device is connected to Wi-Fi.



# Application Settings

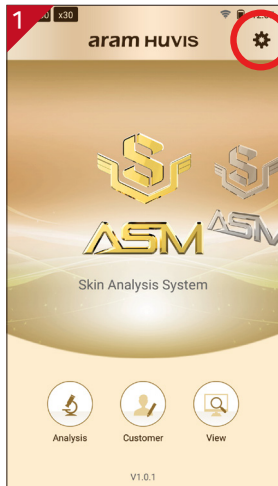

Touch **⚙** button.

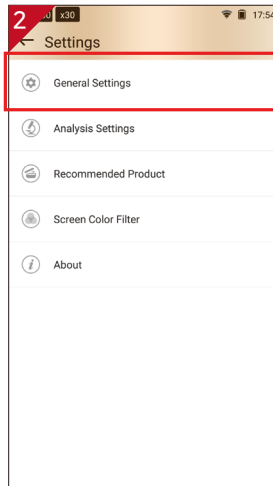

Go to "General Settings".

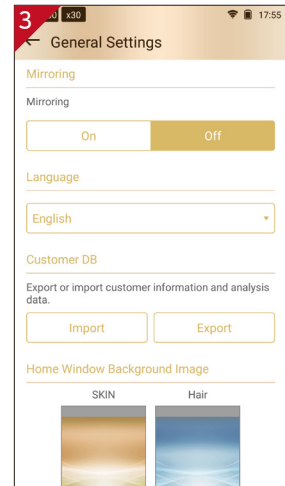

Available to change Language, Version and Email setting.

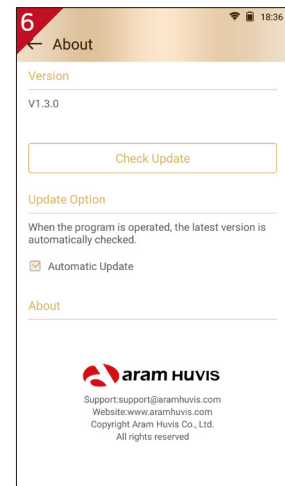
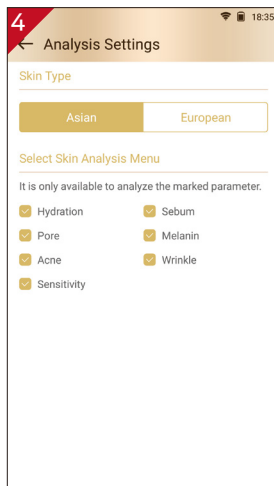

# Customer

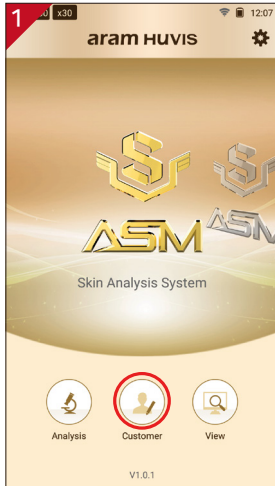

Touch "Customer".

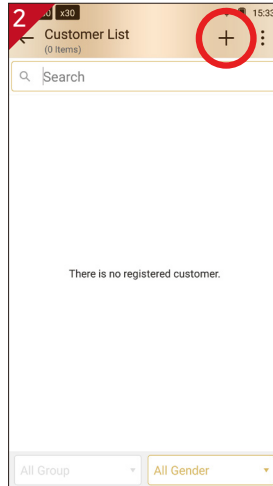

Touch + to register new customer.

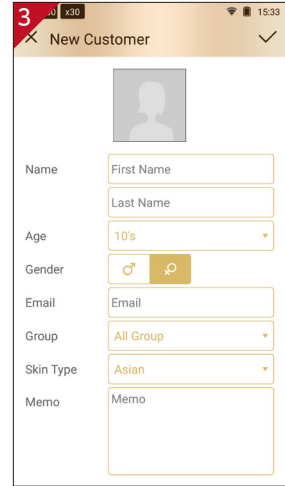

Input the information.

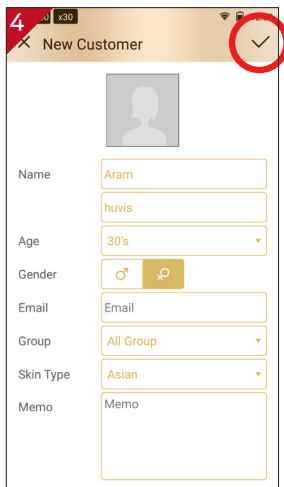

After putting all information, touch ✓.

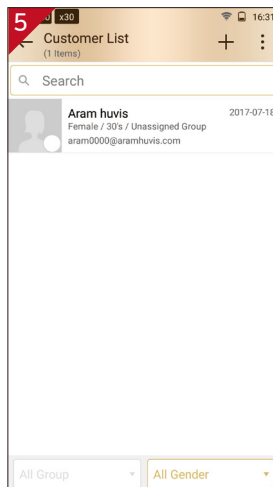

User's profile is created on the list. Then touch user's profile to start analyzing.

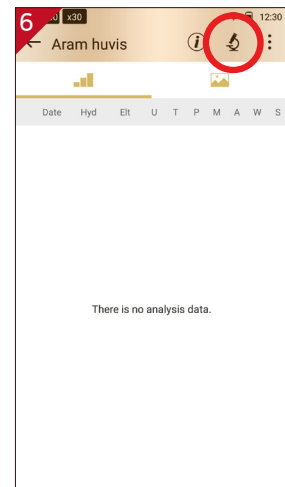

Touch  button to start analyzing.

# Skin Analysis (ASM-100 Lens)

- 1 Press the lens module change button which is located left below of the lens part.

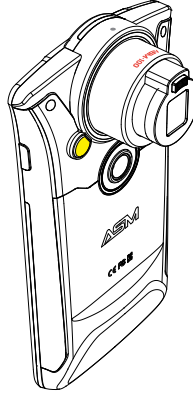

- 2 Rotate the lens anticlockwise, the lens will be able to pull out.

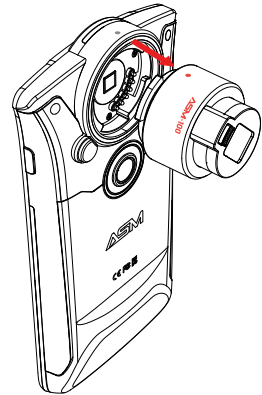
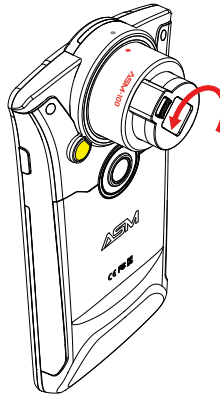

- 3 After fitting the lens, rotate the lens clockwise while pushing in. (Reverse order for inserting lens)

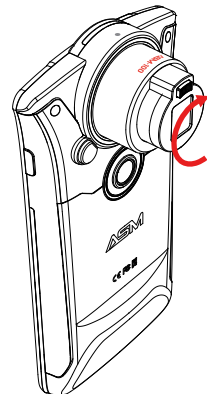
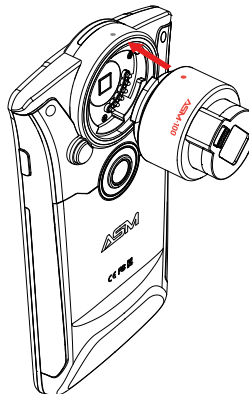

# Moisture

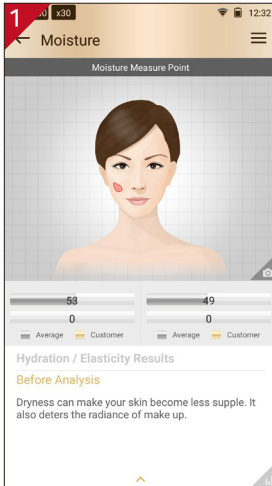

Touch the  button. Please wait until vibration and sound.

\* Never put the sensor on the skin before the message "Touch to skin please".

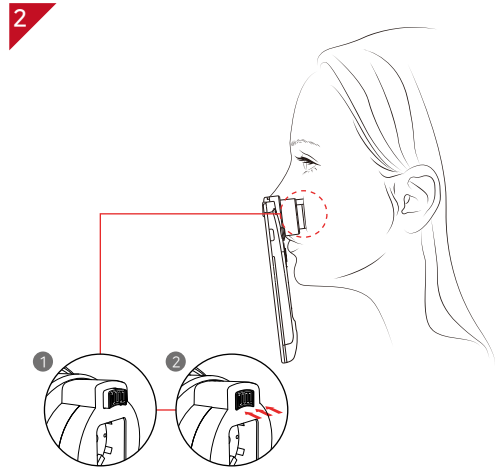

After checking the message "Touch to skin please", push the sensor completely to marked area of the face.

\* All surface of the sensor should be pushed completely.

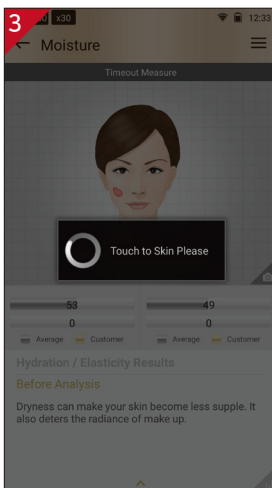

Analyzing hydration and elasticity...

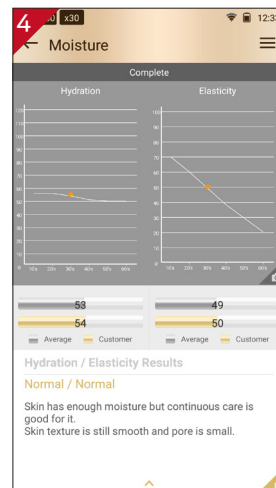

Check the result. To move on next page, slide the screen from right to left.

# Sebum

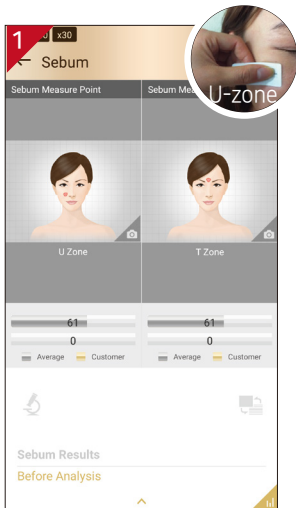

Put the sebum paper on U-zone of the cheek, then press it for 2~3 seconds.

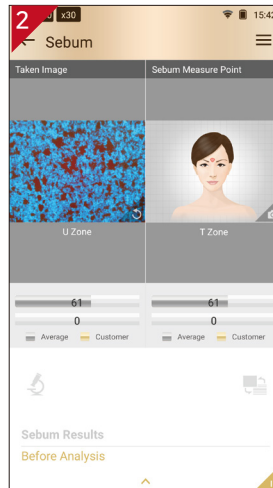

Take a picture of pink area of the sebum paper.

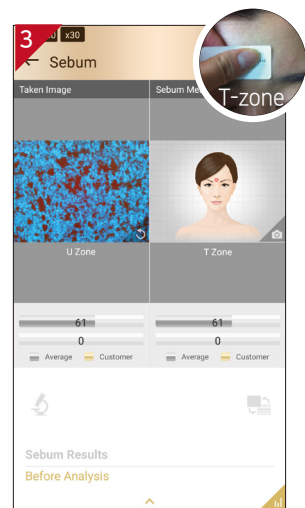

Put the sebum paper on T-zone of forehead, then press it for 2~3 seconds.

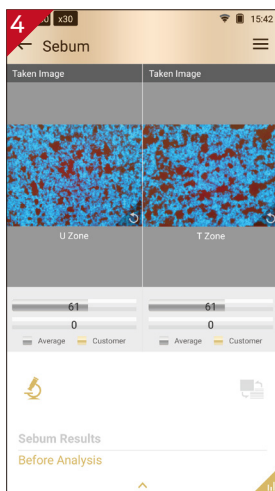

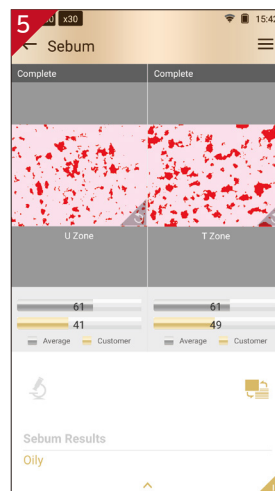

Take a picture of pink area of the sebum paper. Then, touch  button to analyze.



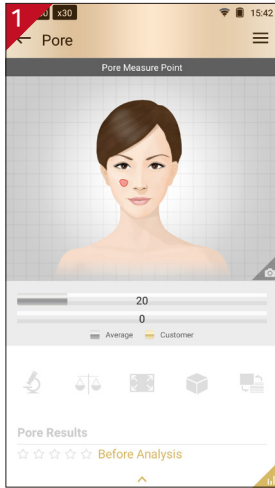

Sebum result will appear.

# Pore

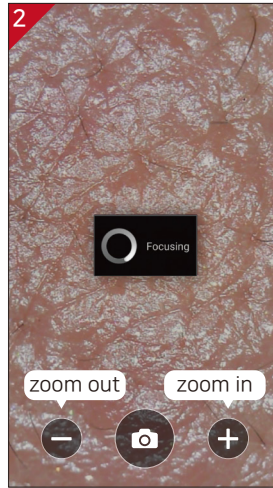

Touch  to activate camera and put the camera onto the marked area of the face.



Touch screen to bring a camera into focus and then touch  to take a picture.

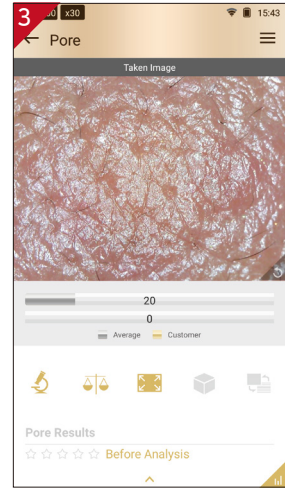

Touch  button to analyze.

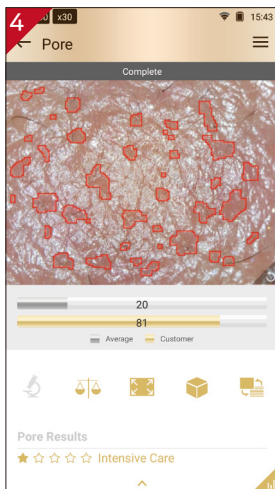

Result will appear.

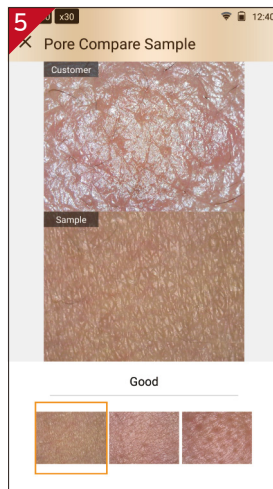

Touch  button to compare taken image with 3 sample images.  
- Good/Normal/Bad





Touch  button to convert taken pore image in 3D.

# Melanin

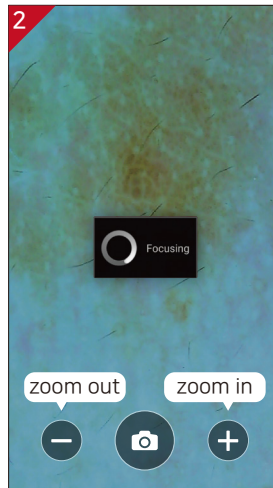

Touch  to activate camera and put the camera onto the marked area of the face.



Touch screen to bring a camera into focus and then touch  to take a picture.

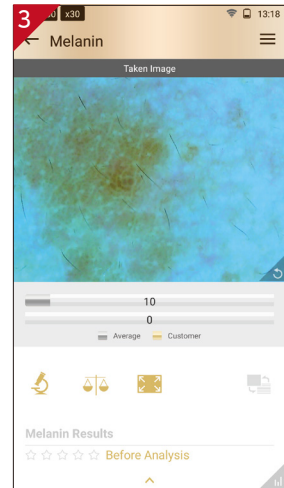

Touch  button to analyze.

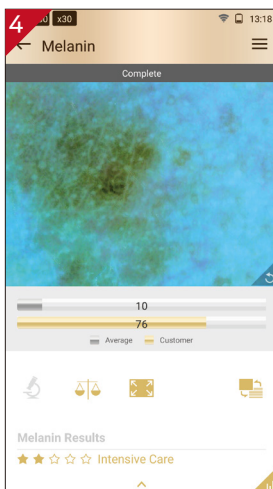

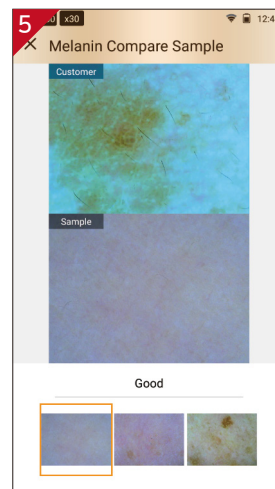

Result will appear.



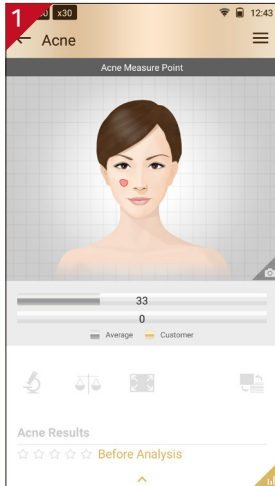

Touch  button to compare taken image with 3 sample images.  
- Good/Normal/Bad

# Acne

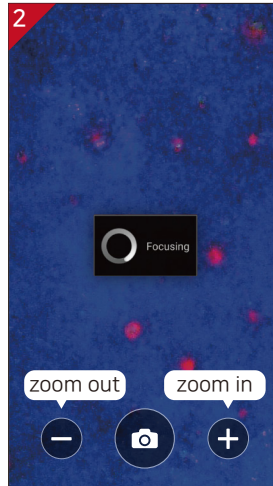

Touch  to activate camera and put the camera onto the marked area of the face.



Touch screen to bring a camera into focus and then touch  to take a picture.

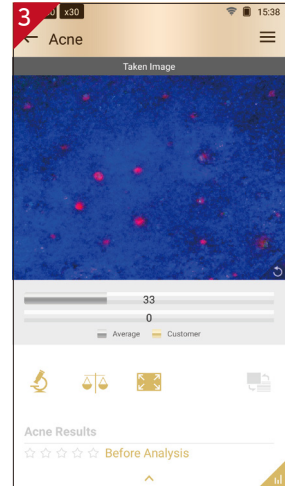

Touch  button to analyze.

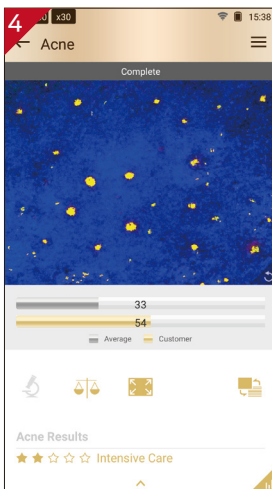

Result will appear.

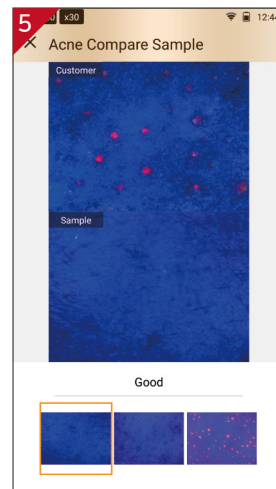

Touch  button to compare taken image with 3 sample images.  
- Good/Normal/Bad



# Wrinkle

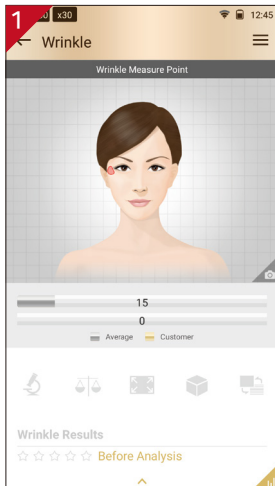

Touch  to activate camera and put the camera onto the marked area of the face.

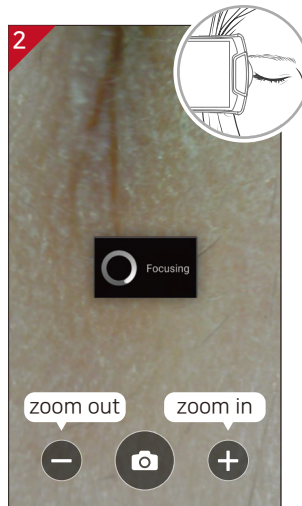

Touch screen to bring a camera into focus and then touch  to take a picture.  
\* For wrinkle photo, take picture of outer eye area in widthways to check crow's feet.

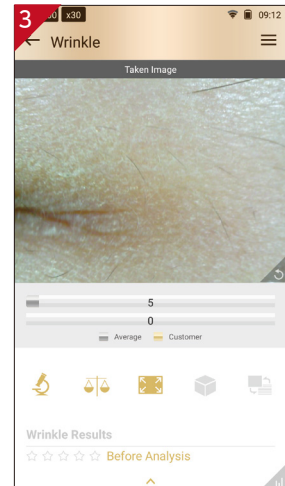

Touch  button to analyze.

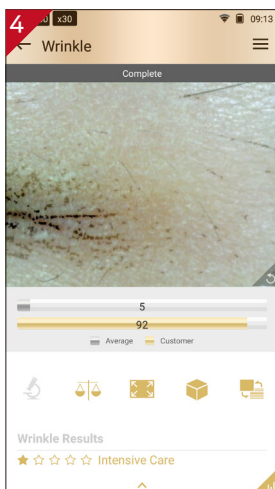

Result will appear.

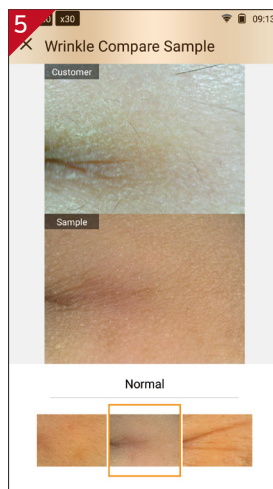

Touch  button to compare taken image with 3 sample images.  
- Good/Normal/Bad

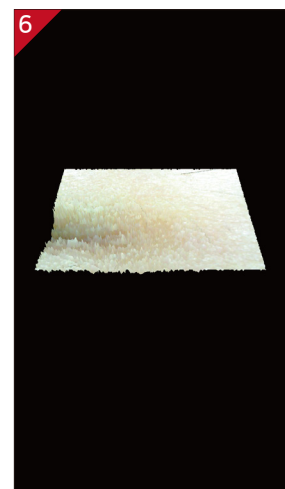



Touch  button to convert taken pore image in 3D.

# Sensitivity

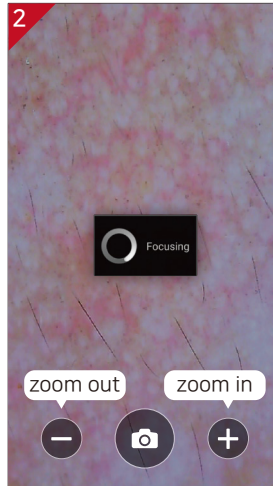

Touch  to activate camera and put the camera onto the marked area of the face.



Touch screen to bring a camera into focus and then touch  to take a picture.

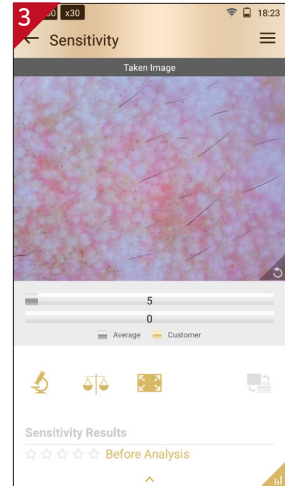

Touch  button to analyze.

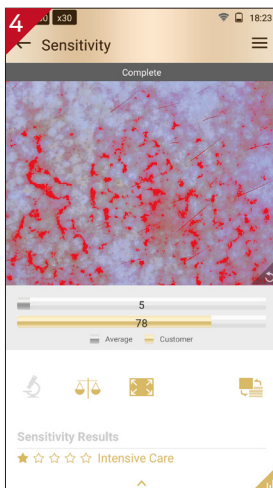

Result will appear.



Touch  button to compare taken image with 3 sample images.  
- Good/Normal/Bad

# Summary

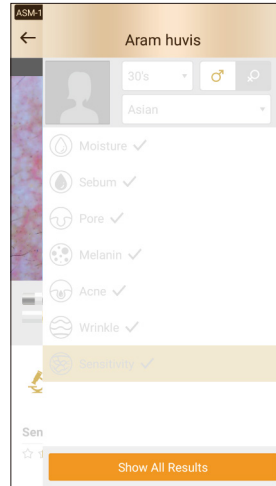
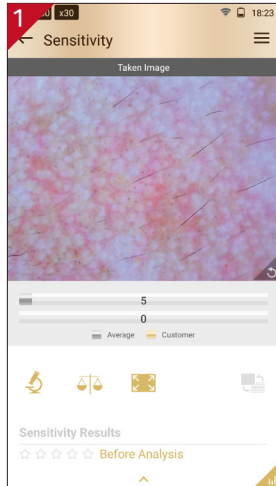

Touch  button or "Show All Result" to see overall result.

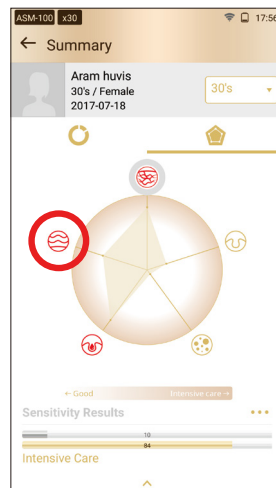
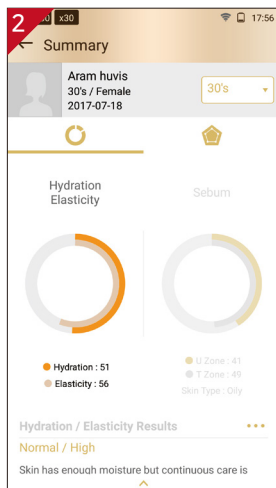

Available to check the result. The worst results will be marked in red.

# Hair Analysis (ASM-202 Lens)

- 1 Press the lens module change button which is located left below of the lens part.

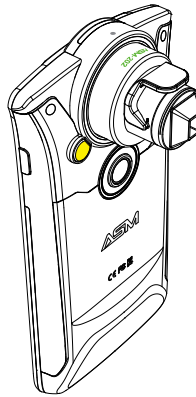

- 2 Rotate the lens anticlockwise, the lens will be able to pull out.

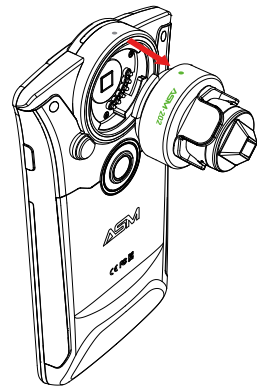
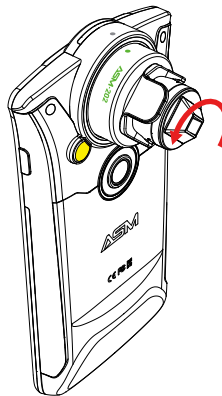

- 3 After fitting the lens, rotate the lens clockwise while pushing in. (Reverse order for inserting lens)

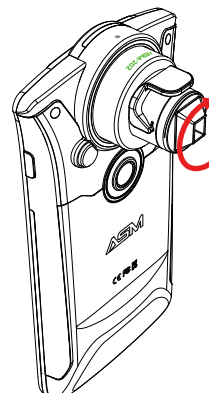
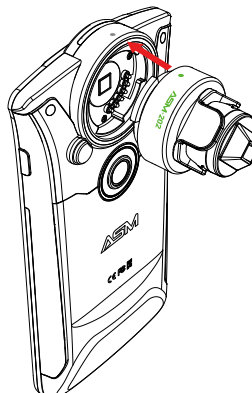

# Hair Loss Status

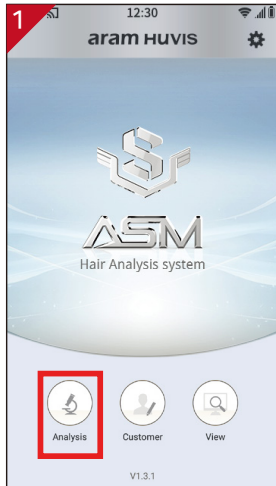

Touch  button.

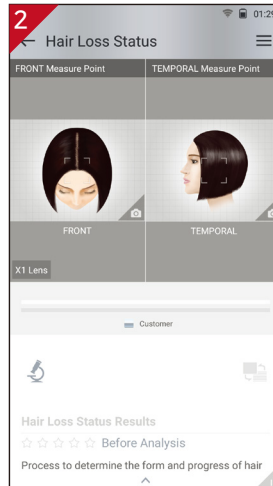

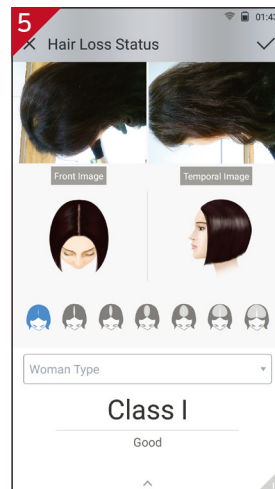
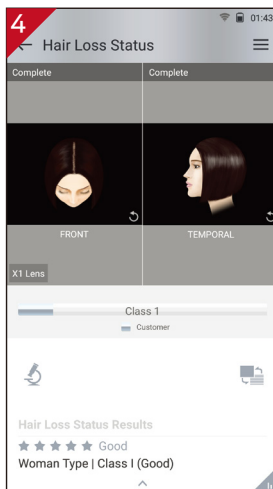
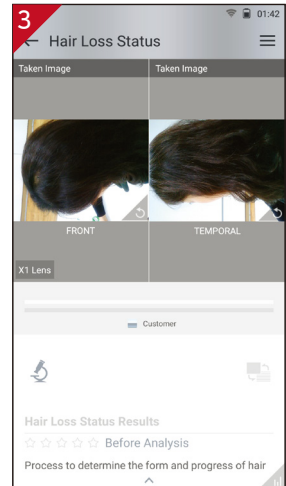

Touch  button to activate camera mode.



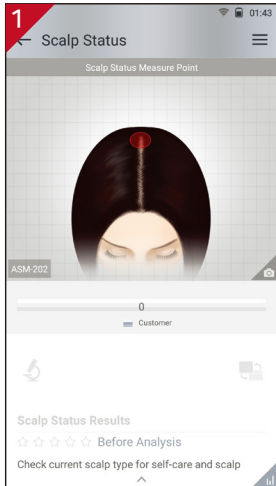

Then select the type which is similar with your hair loss shape.

# Scalp Status

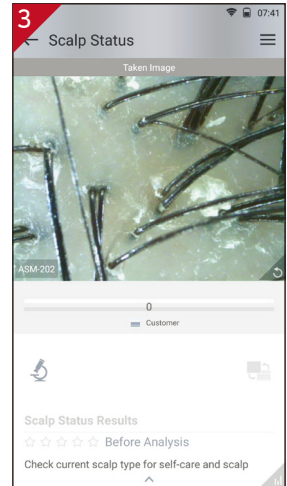
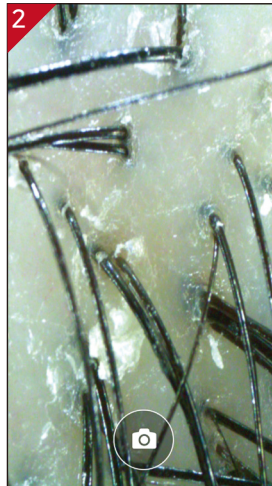

Touch  button to activate camera mode.



Put the camera onto the hair and touch  button to capture the image.



Touch "Analysis" to check analysis result.

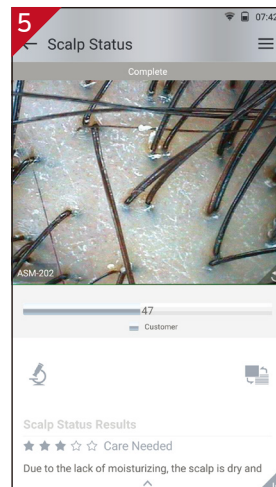

Among the samples, choose the one which is similar with your image.

# Hair Density

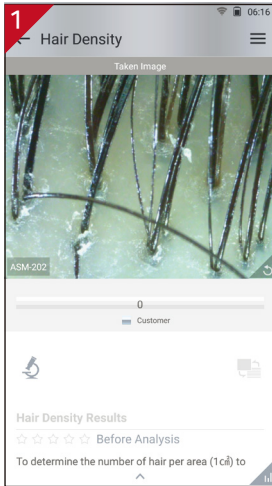

Touch "Analysis" to check analysis result.

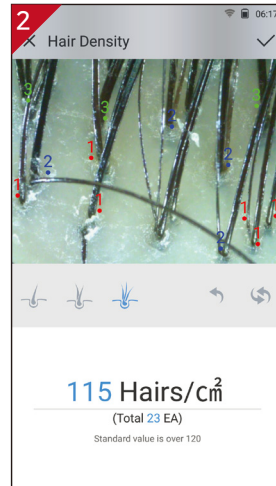

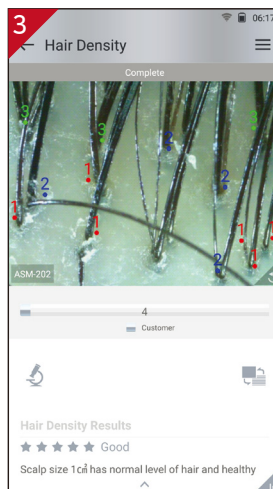

Count the hair number in the image.



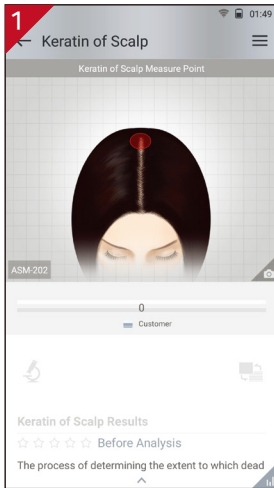

Check the result.  
And swipe to next step.

# Keratin of Scalp

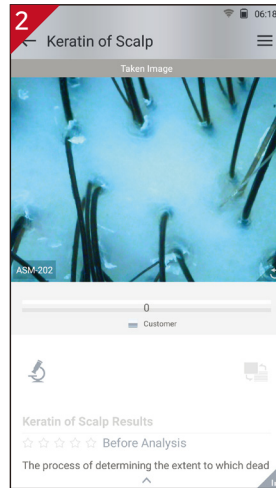

Touch  button to activate camera mode.



Put the camera onto the scalp and touch  button to capture the image.

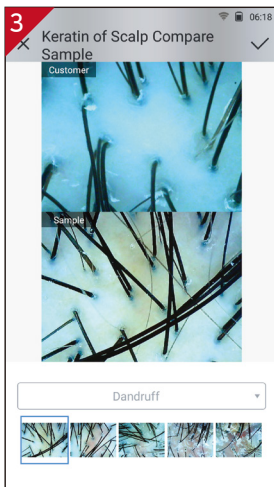

Touch "Analysis" to check analysis result.

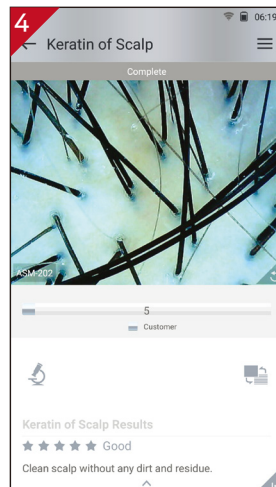

Touch "Analysis" to check analysis result.



# Scalp Sensitivity

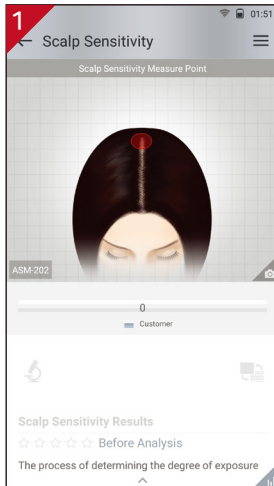

Touch  button to activate camera mode.

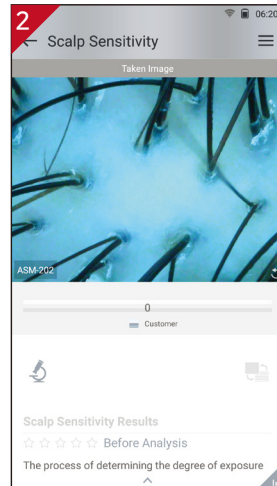

Put the camera onto the scalp and touch  button to capture the image.

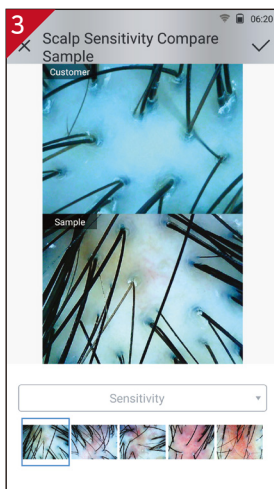

Touch "Analysis" to check analysis result.

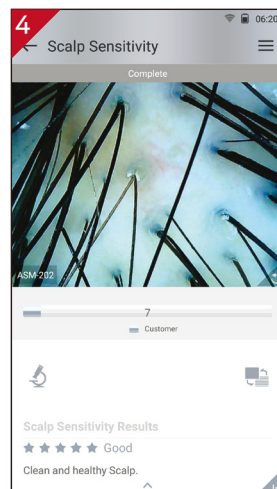

Touch "Analysis" to check analysis result.

# Hair Analysis (ASM-203 Lens)

- 1 Press the lens module change button which is located left below of the lens part.

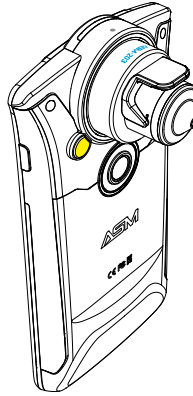

- 2 Rotate the lens anticlockwise, the lens will be able to pull out.

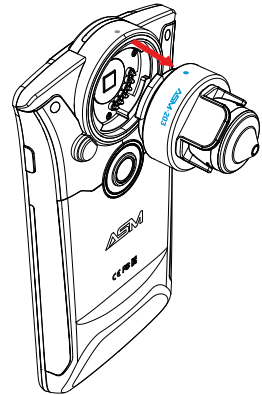
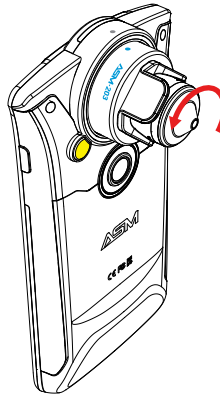

- 3 After fitting the lens, rotate the lens clockwise while pushing in. (Reverse order for inserting lens)

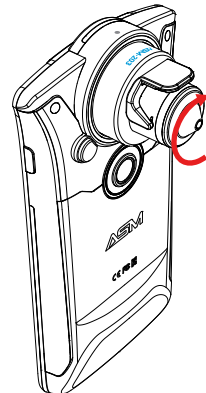
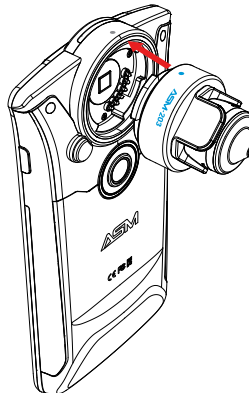

# Hair Thickness

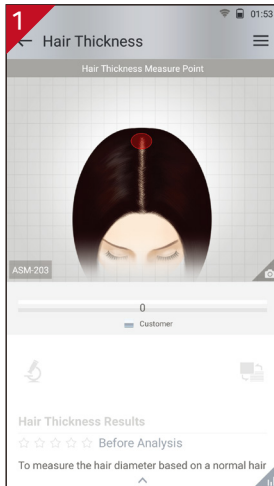

Touch  button to activate camera mode.

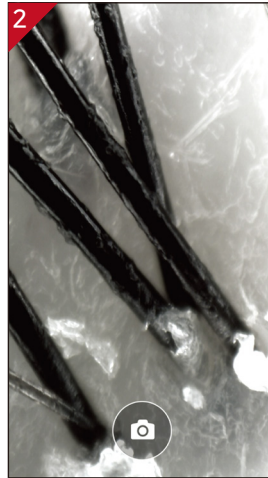

Put the camera onto the scalp and touch  button to capture the image.

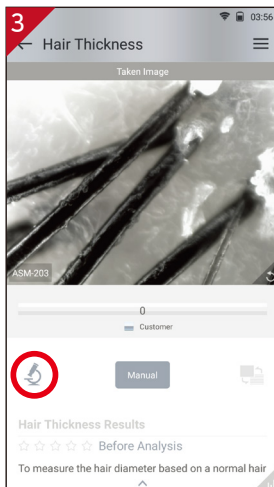

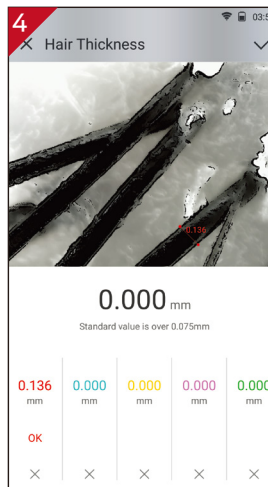

Touch "Analysis" to check analysis result.

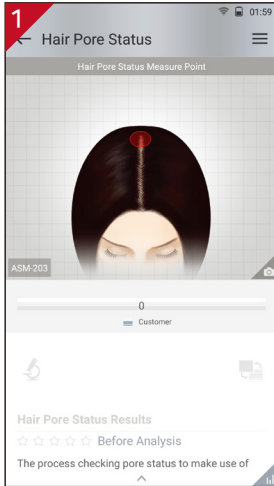

Choose one hair and touch little bit down side of the hair. Then touch little bit upside of the hair. It will make a green line to measure the thickness. (If the line is not correct, please try again)

# Hair Pore Status



Touch  button to activate camera mode.

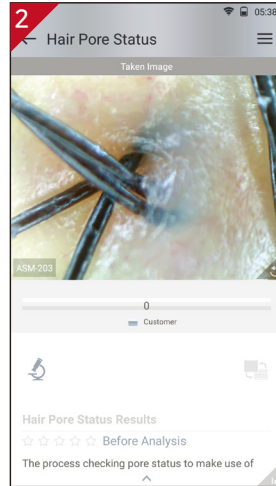

Touch "Analysis" to check analysis result.

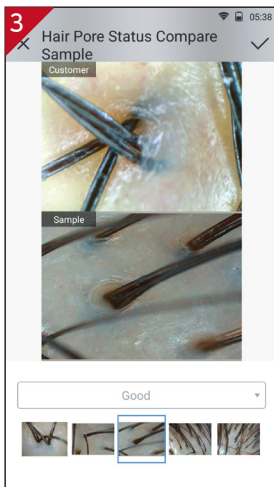

Among the samples, choose the one which is similar with your image.

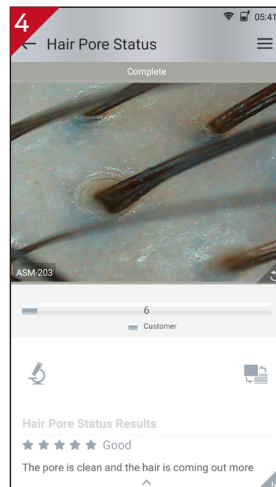

Check the result.  
And swipe to next step.

# Hair Analysis (ASM-204 Lens)

- 1 Press the lens module change button which is located left below of the lens part.

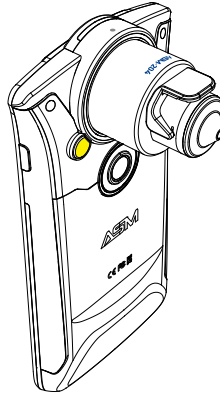

- 2 Rotate the lens anticlockwise, the lens will be able to pull out.

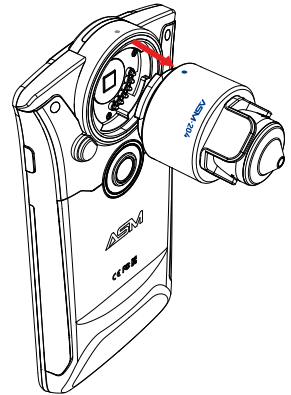
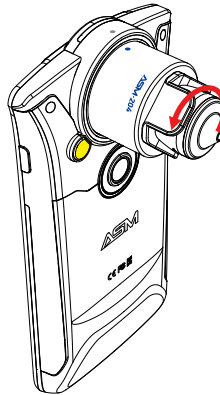

- 3 After fitting the lens, rotate the lens clockwise while pushing in. (Reverse order for inserting lens)

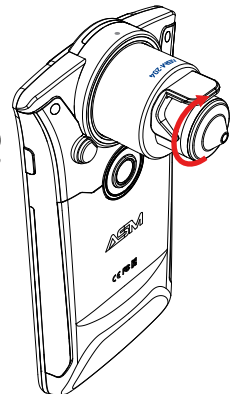
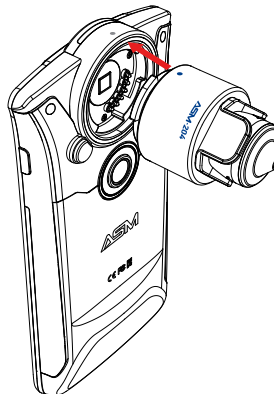

# Cuticle Status

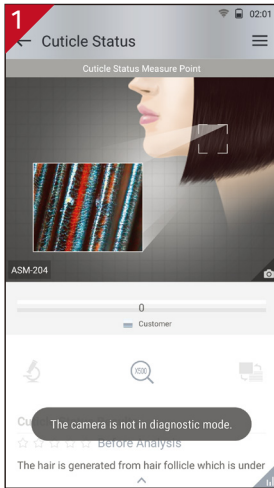

Touch  button to activate camera mode.

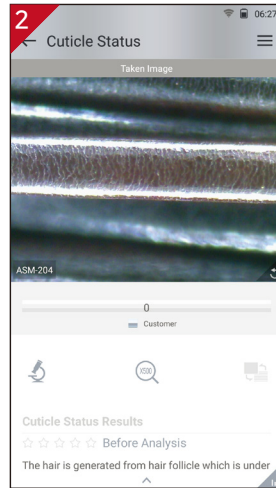

Touch "Analysis" to check analysis result.

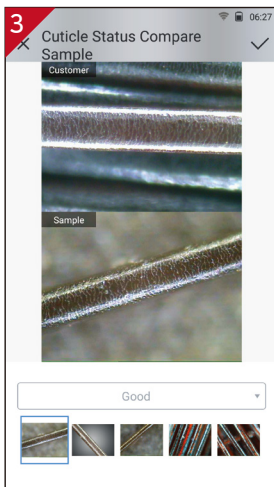

Among the samples, choose the one which is similar with your image.

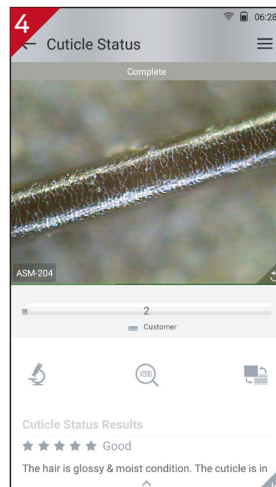

Check the result. And swipe to next step.

# Summary

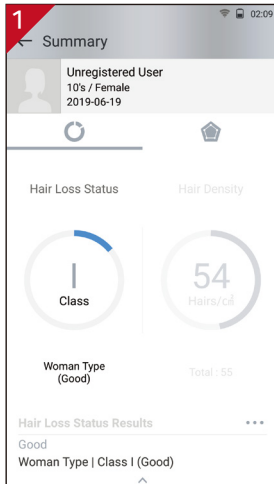

The results will be shown in two pages.

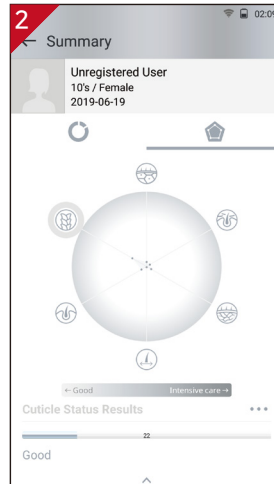

On second page, the description of each parameter would be available by clicking ^ icon.

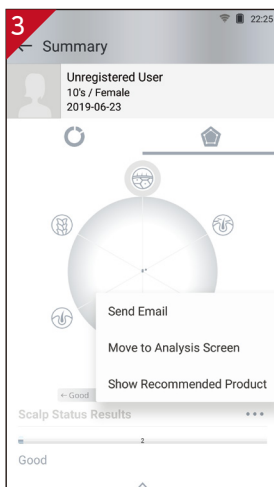

Once you select "Show Recommended Product", product image will pop up as ③.



Available to check product image.

# Send Result - Email

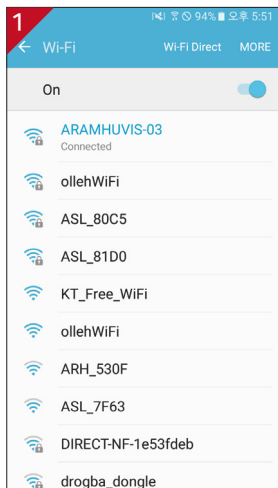

Before sending Email, the device shall be connected to Wi-Fi.

\* Reference : page 8.

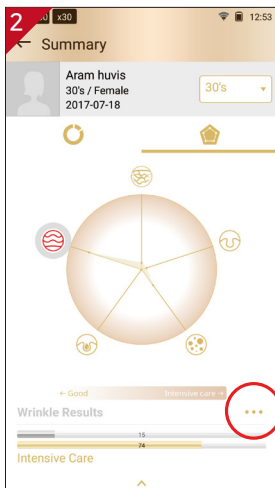

Touch ...

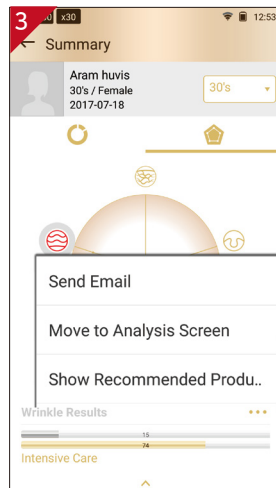

Go to "Send Email".

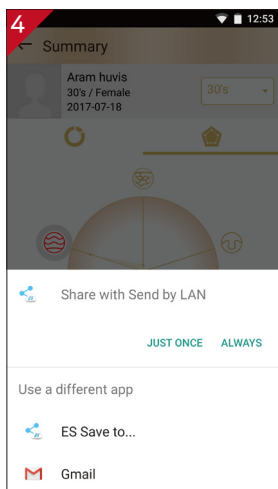

Select "Gmail"

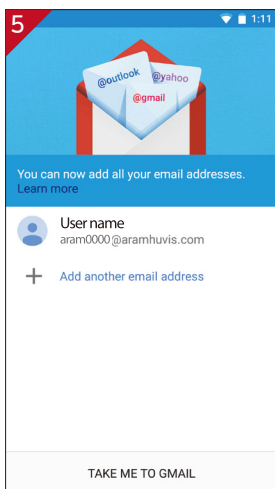

Select the mail account to register on the list.

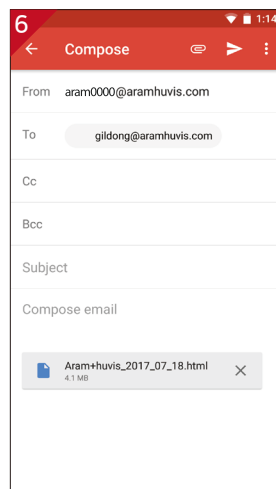

After selecting sender's mail address, put receiver's mail address. Then touch "Send" button.



# Mirroring

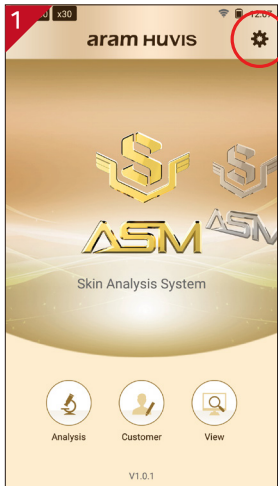

Touch  button.

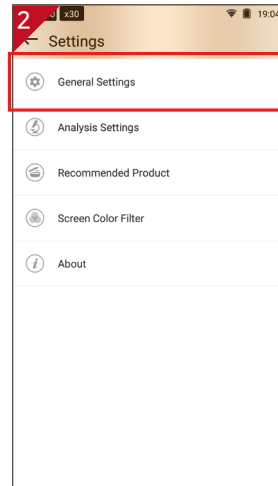

Go to "General Settings".

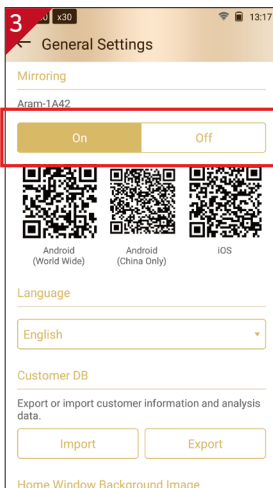

Set the mirroring option "On".

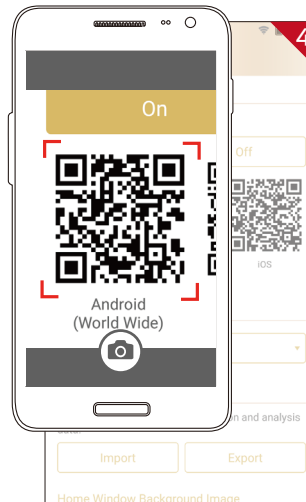

Capture QR code using QR code reader app. Automatically moved to App store.

# Mirroring

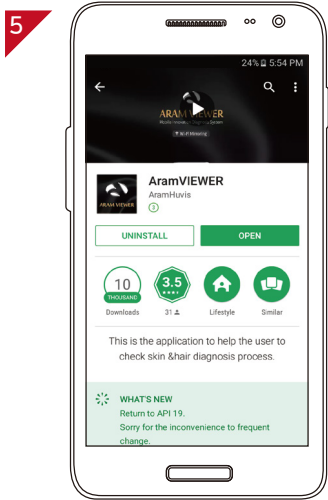

Install "Aram VIEWER".



Then, go to "Wi-Fi Setting".

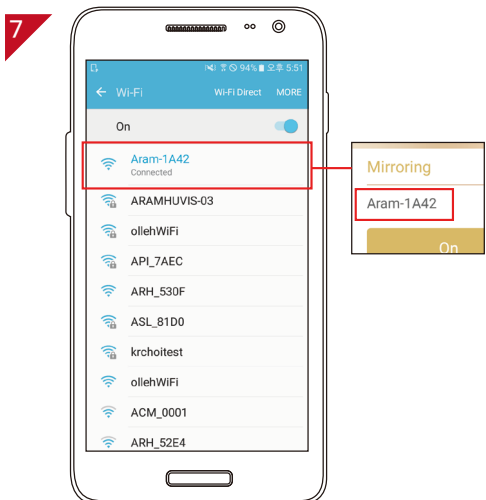

In your mobile device go to Wi-Fi setting. Then find SSID and connect it.

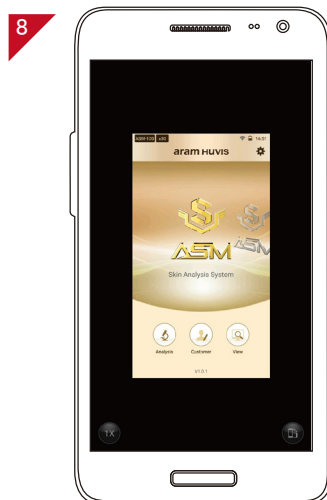

Mirroring will be started.

# View Mode



Touch "View".

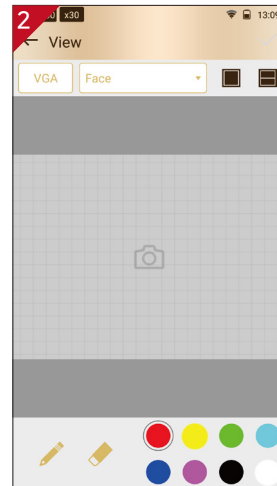

In view mode, it is able to take pictures with capture button.

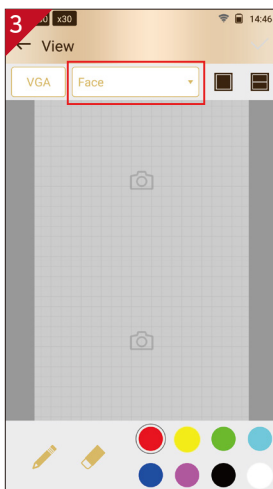

The user can select analysis parameter to take pictures in proper mode.

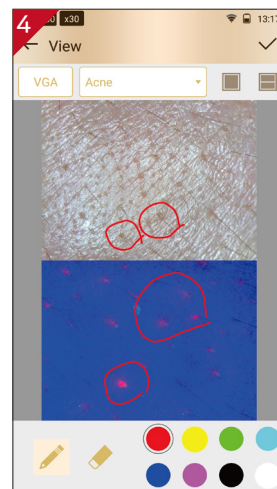

The user can mark the defect or concern according to the image with note function.

# Warranty

- ① The product undergoes strict quality management and inspection process before production and introduction to market.
- ② In case of functional or operational defect occurs under normal condition of use within 10 days after purchase, we will repair it for free or replace in new product.
- ③ When this product goes out under the normal use, we will repair it free of charge under warranty.
- ④ Please keep the warranty card when you ask for repair service.
- ⑤ Customer needs to pay repair charge after warranty runs out.
- ⑥ For this product, warranty period is 14 months from the Invoice date.
- ⑦ Cost
  - Within warranty : Sending delivery(Buyer), repair cost and returning delivery(Aram)
    - If the product is broken by user's fault, repair cost could be charged.
    - After warranty : Sending delivery and repair cost(Buyer), returning delivery(Aram)
- ⑧ How to send :
  - As sending a present from person to person by EMS or FEDEX.  
(Do not write the company name)
  - Total value should be under US \$ 99.(Write non-commercial value)

# Warranty

Service request form			
Date of purchase	/	/	Company
Contact person			
Address :			
Tel :			
Product name, serial No :			
Problems :			

SHIPPING ADDRESS :

#801 Byucksan Technopia, 560, Dunchon-daero, Jungwon-gu, Seongnam-si,  
Gyeonggi-do, 13230 Republic of Korea

Tel: 070-4687-1712 / Fax: 031-732-6330 / Email: support@aramhuvis.com  
<http://www.aramhuvis.com>

# Memo

---

# Memo

---



**HEAD OFFICE**

#401~402 Bundang Seoul National University Hospital Health Care Innovation Park, 172, Dolma-ro, Bundang-gu, Seongnam-si, Gyeonggi-do, 13605 Republic of Korea

**PRODUCTION DIVISION & FACTORY**

#909 Byucksan Technopia, 560, Dunchon-daero, Jungwon-gu, Seongnam-si, Gyeonggi-do, 13230 Republic of Korea

Tel: 070-4687-1712 / Fax: 031-732-6330 / Email: [info@aramhuvis.com](mailto:info@aramhuvis.com)  
<http://www.aramhuvis.com>