

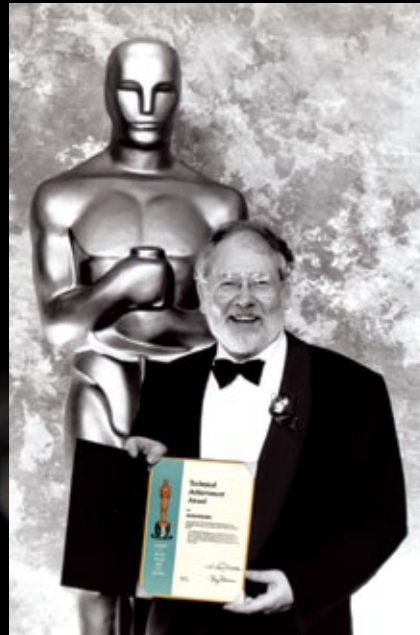

THE TWO FACES OF LIGHT

ENGLISH 09/2011

1990



2002



2010



2003



dedolight® – a story of dedication and success

The first dedolight was built in 1984 with the original concept evolving out of my experiences as a Director of Photography since 1963. For many years, we built only one version and size, and still, it became the single best selling lighting instrument for professional motion picture, television, still photography, and architectural uses worldwide.

By 1990, dedolight and its revolutionary optical principle of the dual lens concept had so successfully established itself as a well known standard in the international film community that it earned the Technical Achievement Award from the Oscar Committee of the Academy of Motion Picture Arts and Sciences.

By the year 2000, larger sizes of lights in both daylight and tungsten were introduced – the Series 400. These dedolights, while incorporating both a patented triple zoom focus and our new patented Double Aspherics² technology allow for further enhanced light output, tighter focusing range, and more even light and color distribution.

Five of the highest awards in the industry

It didn't take long for the revolutionary Series 400 to gain recognition among the professional community. In 2002, the dedolight design team was presented with the Cinec Award, and in 2003 awarded with both a Scientific and Engineering Award from the Oscar Committee of the Academy of Motion Picture Arts and Sciences and an esteemed Emmy Award from the Academy of Television Arts and Sciences.

2003 also hosted the introduction of a new generation of the classic dedolight when we developed a way to incorporate both the qualities of the new generation "Double Aspherics²" system with the added focusing motion into the classic dedolight.

Through the years, we have continued to stay on top of market trends and needs, and while we continue to reinvent our dedolights, we are constantly creating new lighting equipment for the ever-evolving professional. Since we understand that many lighting situations demand both direct light as well as gentle, wrap-around soft light, we also build dedicated soft light sources that offer a distinctly defined clean character beam without compromise.

From the beginning, we have never stopped trying to improve our dedolights and we have relentlessly pursued innovative optical principles and concepts designed to further improve our professional lighting instruments, and it does not end here, it continues to be a day-to-day ingredient of our continued dedication and enthusiasm.

dedolight®, PanAura®, Ledzilla®, aspherics²®, Tecpro®, Fillini® and Felloni® are registered trademarks of Dedo Weigert Film GmbH

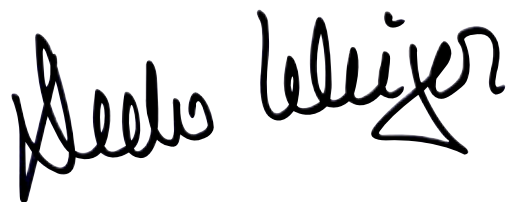























Many lighting situations demand both direct light as well as gentle wrap around soft light. As manufacturers of various types of lighting equipment, we also build dual purpose light sources which may be converted from direct light to a soft light source ... the dedoPAR.

To eliminate having to compromise the quality of light, often common with dual purpose lighting instruments, Dedotec raised the bar and began to design and manufacture totally dedicated lighting instruments:

- Precise focusing instruments with a distinctly defined beam character yet very smooth and even light distribution within the beam
- Dedicated single purpose soft light sources, that are best suited for the task without compromise
- Now offering the image creator both faces of light

dedolight
... dedicated to the art of lighting

Table of Contents

Introduction		3
The many uses of dedolight®		6
Feature Films and TV Drama		6
Commercials		7
Special Effects		7
Documentary		8
Mobile Crews		8
Architectural Photography		8
Product and Portrait Photography		9
Museum Lighting		10
Scientific and Industrial		10
dedolight® Technology		11
Series 400	 	17
Series 400 Accessories		26
Series 400 Imager		27
Series 200 - Sundance		30
Classic Series		33
Power Supplies		38
Battery Belts and Packs		41
Camera Light		43
Lamps		44
Accessories		45
Filters		46
Reflectors/Diffusers		47
Imaging		48
Mounting Accessories		53
dedocool		55
Equipment Cases		56
dedolight Kits	   	60
Soft Box Options		88
Photometrics		90
Index by Product Code		96
Photo Credits		97

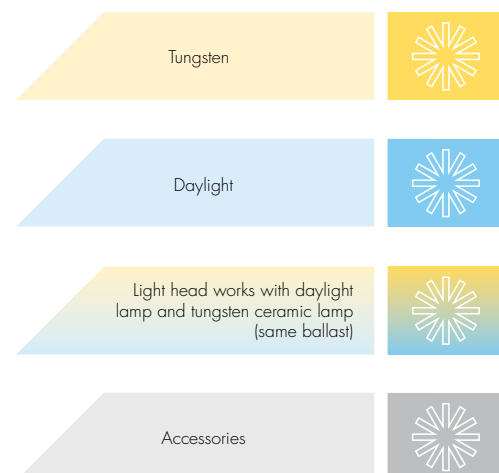

Catalog 8/2011

dedolight® and Aspherics² are registered trademarks of Dedotec Optronische und Mechanische Systeme GmbH.

All other trademarks are the property of their respective companies. We reserve the right to change, in whole or in part, prices, product specifications, products offered, terms and conditions of sale, and policies without notice. A complete copy of the dedolight warranty is available upon request.

©2011 Dedo Weigert Film GmbH. All Rights Reserved

Feature Films and TV Drama

General lighting in feature films has been a fantastic success for dedolight. Although a number of feature films were lit exclusively with dedolight, they are generally used to augment other conventional and fluorescent light sources.



Jürgen Jürges, DoP

(We children from Bahnhof Zoo, Funny Games, About the looking and finding of love)

„For me, the system offers a wonderful opportunity to light distant, hard to reach parts of the set with great precision and without flattening the rest (remainder). I won't shoot without them.“

This was one of the first compliments we received for our clean beam concept and no stray light.



Julio Macat, ASC

(Home Alone I-III, The Nutty Professor, Wedding Crashers)

„We were trying to create several hot spots on a table in a conference room with a very low ceiling that would up light and light the actors. I was really impressed by the amount of light the dedolights put out and the quality was... wonderful.“

Many top directors of photography have made both the classic and Series 400 dedolight a standard part of their tools.



Tom Stern, DoP

(Mystic River, Million Dollar Baby, The Exorcism of Emily Rose, Letters from Iwo Jima)

„Every rose in ‚American Beauty‘ was lit with a dedolight. We would have been lost without it.“

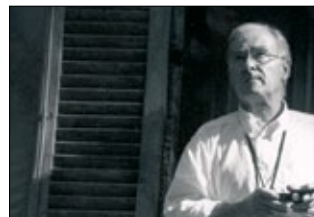

Dante Spinotti, AIC, ASC

(Heat, The Insider, Red Dragon, Pinocchio, X-Men: The Last Stand, The Tourist)

„The fact that I could easily control the light with the dimmer and the beam with the barn doors...made that light priceless.“

The larger Series 400 lights have also established their role in general lighting for feature films. When creating highly defined lighting effects, these lights offer unequalled qualities.



Steven Poster, ASC

(Stuart Little I-II, Donnie Darko, Daddy Day Care)

„On ‚Donnie Darko‘ I used it to simulate a projector in a movie theatre.“



Russell Carpenter, ASC

(Titanic, Charlie's Angels I-II, True Lies, 21)

„The dedolight 400DT is the missing link in my lighting arsenal.“

The special character of the dedolight escapes technical definition, but refers to the subtle uniqueness of the light created by these instruments.



Duncan Brown, DoP

(You Rang My Lord,
Tales from Hollywood,
The Maitlands)

„It cuts like a rapier in a swath of soft light.“



Roy Wagner, ASC

(CSI: Crime Scene
Investigation, Drop Zone)

„It’s like working with an instrument...like a musical instrument. It’s a wonderful painter’s brush that’s not just one type of brush. It’s a multi valuable tool.“

Special Effects

Special effects for many top feature films were lit with dedolight. Some exclusively, others with special requirements such as a high speed sequence in ‚Armageddon‘.



Doug Trumbull

(2001 A Space Odyssey, Blade
Runner, Close Encounters of the
Third Kind)

„For the ‚Back to the Future‘ OMNIMAX ride, dedolights were the answer. We developed an entirely natural look by breaking our key down into many individual beams. I’ll never shoot without them.“



**Dave Hardberger,
Special FX**

(Lord of the Rings I & III, Final
Destination I & II, League of
Extraordinary Gentlemen)

„They’re extremely controllable, they have the intensity and they’re also really small so you can hide them behind a lot of things and still do a camera move. I’m very happy with them, very good!“



**Nigel Stone, BSC
Special FX**

(Harry Potter I-IV, V for Vendetta,
Charlie and the Chocolate Factory,
The Brothers Grimm)

„I have been an admirer of dedolight since they were first available in the UK and I would not like to go into a VFX shoot without being able to call on them.“



**Peter Parks
Gordon E. Sawyer Award for
lifetime achievement (A.M.P.A.S.)**

(Solar Crisis, Superman, Bugs!,
The Fountain)

„I can truthfully say that without the dedocools, the optical advances that I pioneered in both 2-D and 3-D would not have been possible.“

Several dedolights may be used to create the impression of rays emanating from a single hidden source. The use of parallel beams creates the impression of a far away light source. Conventional single sources would noticeably give away the fact that the sun is placed directly outside the studio window.

Commercials

When shooting commercials great care is taken to make products, cosmetics or food look the most attractive. Here, both classic and Series 400 dedolights have become a standard for lighting defined and at the same time subtle effects.

The Imager projection attachment provides unsurpassed precision for highlights, reflexes and incredibly small accents.

The Series 400 lights are also used to light women's close-ups, with no added diffusion – a compliment to the silky smooth light distribution within the beam.



Stuart Harris, DoP
Commercials

„The quality of this light really has to be seen to be believed. An essential part of my lighting equipment especially for glamour.“

Documentary

dedolights have also found their place in documentary applications. Versatile, compact, rugged, lightweight multi-fixture packages with several power options allow a highly differentiated way of lighting. Super quick setups under short time constraints as well as wonderful nuances of subtle lighting have left the dedolight mark on these applications.



Duri Mayer,
Cameraman

(Icewalk-Adventure North Pole,
Sturmflut)

„In ‚Project Icesail‘, three dedolights were affixed to the masthead of a sailing ship, mounted in March and derigged in September. The two 150W dedolights still functioned on the very last day and we never had to change a bulb. Compliments!“



Tom Zannes, †
Cameraman

(Descent Into the Black Hole,
Marathon of the Sands, National
Geographic)

„We found formations that were in distant hard to reach areas of the cave that we couldn't put light in with a normal unit. We had to shoot everything with batteries so we had to be very efficient. The dedolight really increased our capabilities in the cave.“

Mobile Crews

In many countries, the light weight dedolight soft case kits have become the standard for mobile crews. dedolight systems offer many choices, from basic interview to subtle artistic lighting even under extreme time constraints.



Jonathan Harrison,
Cameraman

„The control, versatility, dependability and light output of the dedolight are still unsurpassed. The only downside is that it's addictive.“

Scientific and Industrial Lighting

dedocool lights provide extremely high light intensities for use with high speed film and video but without the soaring heat normally associated with high intensity lighting instruments. Also used for motion analysis, special effects in films and many other scientific fields.



Product and Portrait Photography



dedolights are often used in portrait photography to create a „Hollywood“ style of portrait lighting. Direct, soft, gentle and moody styles may be achieved.

dedolights are indispensable for product photography. The classic dedolight as well as the Series 400, in conjunction with the imager (projection attachment) allow the creation of the finest, most precise, highly tuned accents, which cannot easily be recreated in Photoshop. On a high class product shot you may easily find twelve to fifteen dedolights to highlight details, create subtle reflexes and convey the feeling of structures and plasticity. Some photographers go beyond the classic product approach and use the creative potential of the dedolight to make lights a visible part of the image composition.



**Marek Czarnecki,
Photographer**

(Awarded the British OSKAR statuette in the category of Advertising and Illustrative Photography)

„The creative possibilities of the dedolights have changed my approach to photography. I have discovered a new world of images and the creative tools that I now possess have become a challenge for my future work.“

Car photography is usually done with huge soft light sources. It's a remarkable exception when some of the most successful car photography is done with a multitude of dedolights, painting details and reflexes one by one.



**Taly Noy,
Photographer**

(East Side Studios, England,
Car Photography)

„This lighting system offers almost surgical precision to the professional photographer, eliminating time wasting trials and imbalance of light, whatever the subject.“



THE MANY USES OF DEDOLIGHT®

Illuminating the delicate shapes of a sculpture or lighting an oil painting, one could easily choose the traditional approach of cross lighting with conventional sources thus losing the charm of the surfaces structure. dedolight allows an unbalanced lighting approach, making the structures of a painting visible, whilst giving subtle modeling to the surface and totally evening out differences of exposure when used with the new dedolight graduated grey filters.



Charles Masters,
Photographer

„The control of the light cannot be compared to other systems“

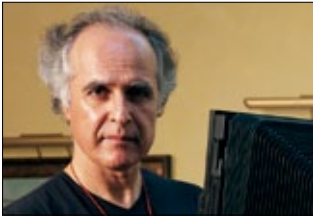

Ahmet Ertug,
Photographer

„I used dedolights to obtain a superb result in achieving a very controlled mood of mysticism.“



Architectural Photography

Several photographers have used dedolights to light large churches and cathedrals as dedolights are easily hidden within the shot and allow differentiated lighting which creates a sense of depth, structure and mood beyond the pure portrayal. Michel Escourbiac's photographic works are published in books about cathedrals.

„For all of this work, I have used dedolights. I need very focusable, pointed light sources. Fortunately, dedolights are powerful over a long distance and I have used them at distances up to 70 m (200 ft.) to bring out the materials, the colors, the gold...“

Michel Escourbiac



Museum Lighting

dedolights illuminate paintings, sculptures and other art objects in many museums around the world. The unprecedented qualities of dedolights provide precision lighting in many variations. Defined illumination guides the visitors' attention with a choice of levels from subtle enhancement of detail or noticeable and distinct accent to dramatic presentation. No other lighting instruments offer UV values as low as dedolights (with UV filter option) which aids the conservators' task in preserving valuable and delicate objects. See architectural catalog or www.DLAD.eu.



The Optical System

The original dedolight patent introduced a second lens which provides several advantages over traditional Fresnel systems:

- Produces a unique character of light.
- Pre-collects the light from the lamp and reflector allowing the use of a smaller front lens and thus enabling the construction of a smaller light head.

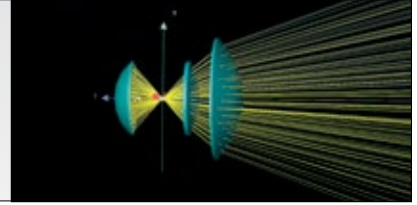

- Provides light output comparable to much larger light sources.



- Raised the light efficiency in spot position to 18% versus only 6% found in traditional Fresnel designs.



- Provides a focusing range (change in intensity from flood to spot) of 25:1 versus the 3:1 range of similar lights.

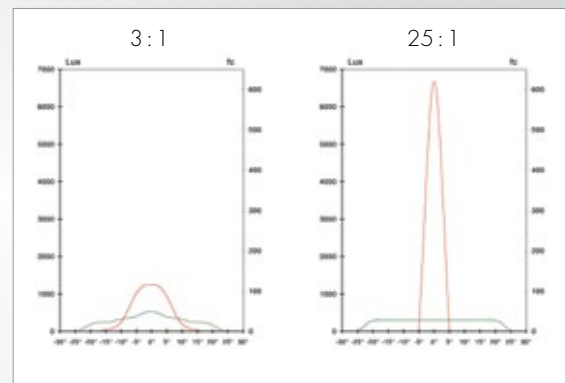

- Provides a clean beam without stray light as usually found in Fresnel lights.



- Offers very even light distribution within the beam versus hot spots produced by Fresnel studio lights.

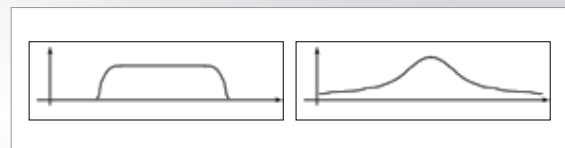

Low Voltage Lamps

Using low voltage lamps offers several advantages compared to traditional light sources:

- They produce up to 40 lumens per watt (versus 20-25 lumens per watt of high voltage halogen lamps), further contributing to the enhanced light output.
- They provide tremendous savings in operating cost due to their very low price and long life.
- They are much less susceptible to premature lamp failure due to shock and vibration, allowing their use in rough applications where line voltage lamps may fail instantly.

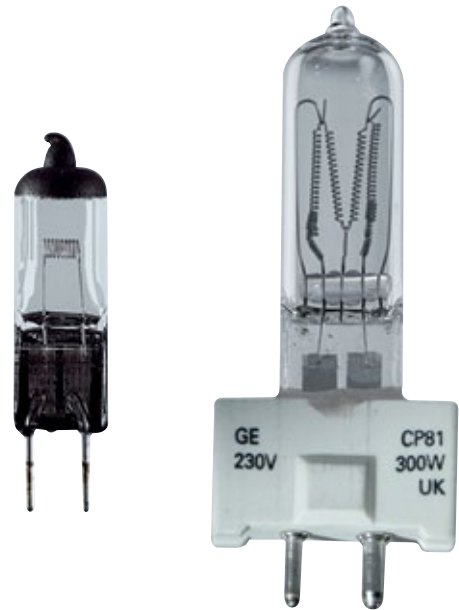

Adding to the economic benefits:

- The dedolight DLH4 light heads may be used in rain, snow and although not recommended, have been demonstrated while totally immersed in water.
- These lights may be used with our wide choice of AC power supplies and DC batteries.



The Lenses

Four years of optical research and development led us to further improvements in professional lighting. The resulting patent introduces a relation computed double Aspherics² system.

aspherics²

DOUBLE ASPHERIC TECHNOLOGY

This development offers solutions to two problems:

Light distribution:

Traditional studio lights show light distribution with hot spots or in some focusing positions „hot shoulders“ (brighter rims with darker centers).

The dedolight double Aspherics² system offers edge-to-edge, perfectly even and smooth light distribution in all focus positions that is even cleaner than the previous generations of dedolight models.

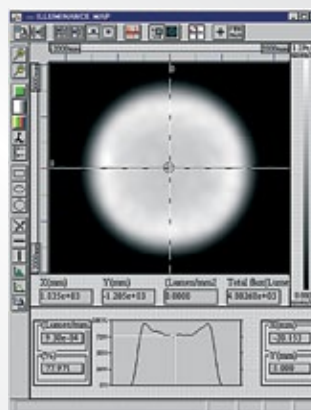

Light distribution of a traditional source

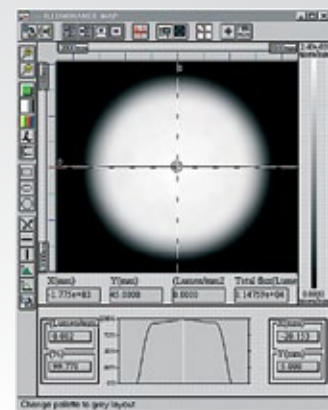

Light distribution of a double Aspherics² dedolight

Color distribution:

Discharge lamps do not have homogenous color properties, which often lead to bluish rims in some focus positions.

Our patented double Aspherics² system provides significant improvement in the color distribution across the entire lit field.

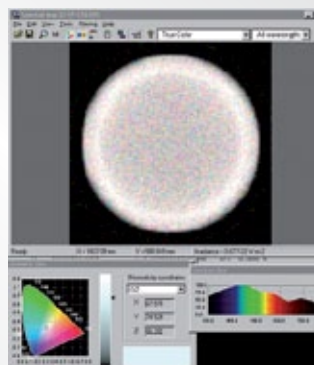

Color distribution of a traditional source

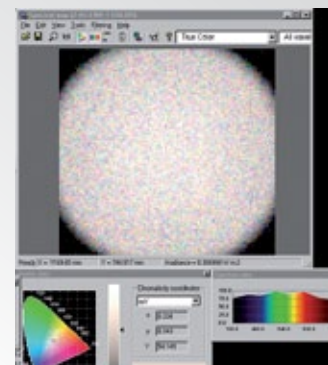

Color distribution of a double Aspherics² dedolight

The Mechanics

An additional patent introduced the added movement of the second lens in relation to the lamp and reflector all being controlled by one focusing knob. This technology was first used in the dedolight Series 400 as a triple zoom focus.

- 20:1 variation of intensity from spot to flood – Series 400
- 25:1 variation of intensity from spot to flood – Aspherics²

Motion 1

From flood to super flood

Lamp and mirror move closer to the second lens.

Motion 2

Mid range

Lamp, mirror and second lens move in equidistant unison.

Motion 3

Spot to super spot

Second lens stops while the lamp and mirror continue their travel.

No traditional Fresnel even comes close.

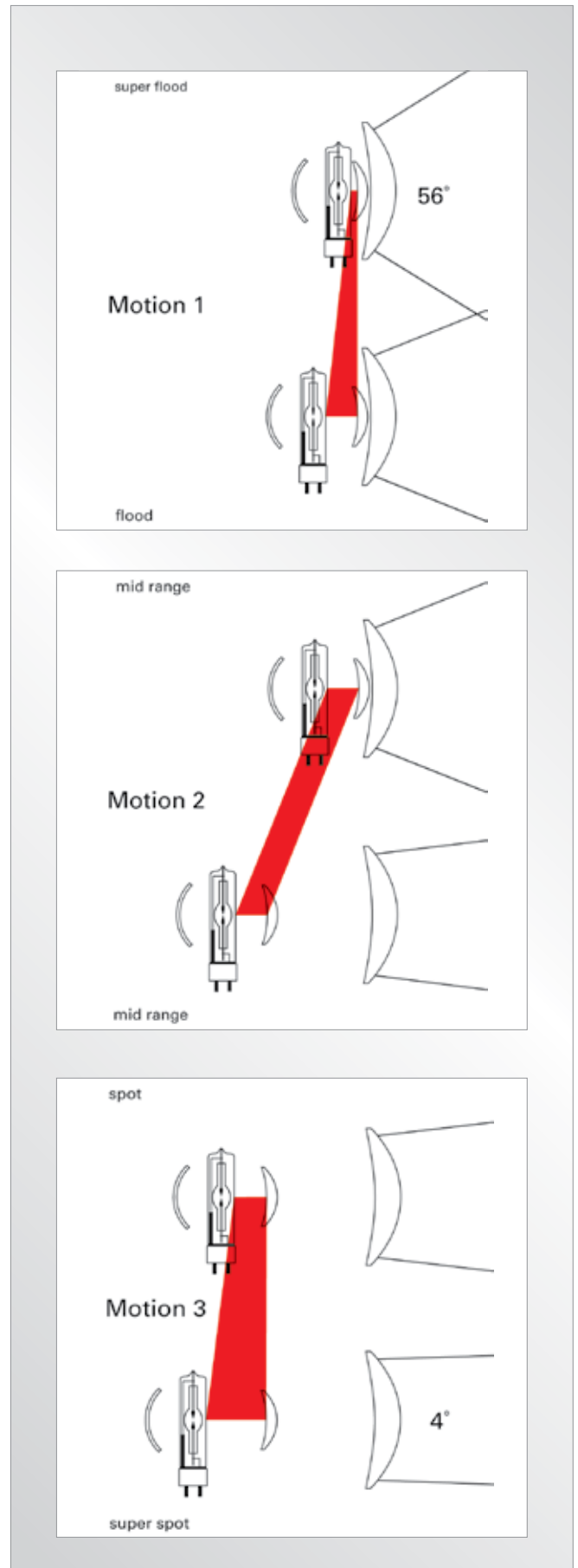

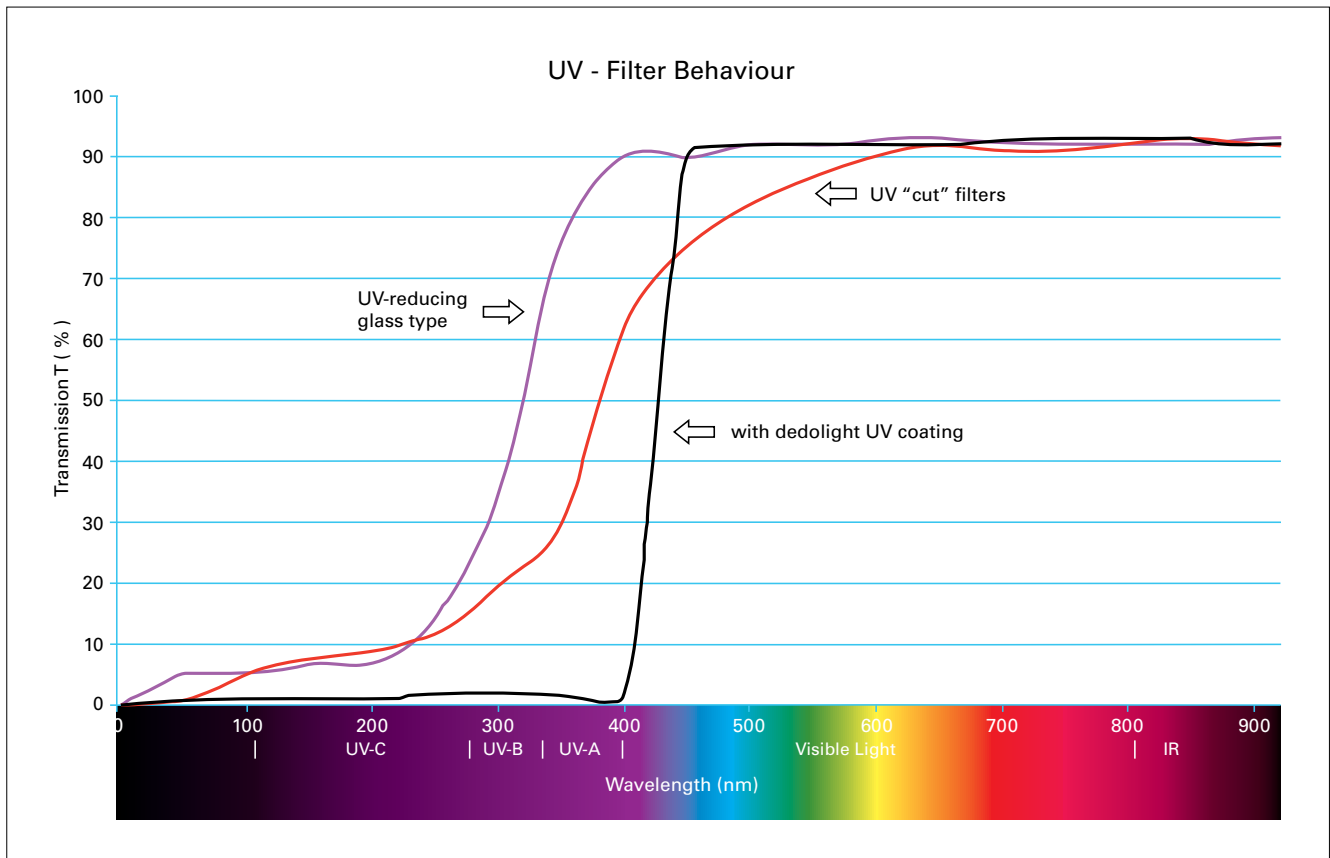

UV Radiation

UV radiation is produced by many light sources. UV-C, the shortest wavelength, is the most hazardous type of radiation, and although natural sunlight contains a great deal of UV-C, this is fortunately filtered out by the ozone layer. Using artificial daylight sources like metal halogen, we are also subject to dangerous levels of this type of UV. No metal halogen light source should ever be used for direct lighting of people or sensitive objects without some form of protection.

A degree of protection may be provided by additives to the glass during manufacture or by utilizing special UV absorbing glass. This type of filtering may produce a color shift and loss of light, and still won't entirely cut out UV.

We have been successful in developing a filter coating which effectively cuts UV-A, UV-B and UV-C radiation below 405 nm. This coating is deposited on the inner side of the front lens and does not affect the visible light, color rendition or transmission. The UV emission of our daylight sources (DLH400DT and DLH200DT) is approximately 1/20th (5%) the UV emission of comparable light sources.

On our 400/575 W and 200 W daylight soft lights we utilize a doted quartz glass tube which effectively lowers UV values giving significant advantages over similar light sources. Our Series 200 lamps are manufactured with a UV stop envelope which does not lower UV values beyond our coating, but may be regarded as a backup safety.

The UV content from halogen light sources is regarded as less harmful to people lighting but will still affect sensitive objects such as textiles, paintings and photographs. We offer an optional UV protection which is commonly used in museum lighting. Our special dichroic filter technology offers the lowest UV values in the professional lighting world.



The Imager Projection Attachment

Building highly perfected optics for dedolight light heads, allowed us to design imaging attachments with matching optics for unprecedented precision, quality of image and light/shadow shapes.

- High light efficiency due to matched optics
- Perfect contrast rendition
- Very low distortion
- No color fringing (as displayed by practically every traditional profiler/ellipsoidal)
- No halation which on other instruments often impairs the shadow edge rendition or affects overall contrast
- Interchangeable lenses from wide angle to telephoto and zoom

- For the Series 400 we have designed several unique projection lenses which provide extreme light transmission and remarkable qualities.
- Wide variety of accessories:
 - Framing shutters
 - Iris
 - Gobo holder (steel and glass)
 - Slide projection with heat reducing filter and forced air cooling
 - Optional image plane adjustment to correct focus shifts in off axis projections
 - Gobo rotator

Note:

dedolight heads and Imager projection attachments are designed with a matching optical system to optimize light output and distribution. Our Imagers are occasionally used on light heads of other manufacturers. Although possible, efficiency and image quality will be drastically reduced.

DEDOLIGHT® SERIES 400



When the larger Series 400 lights were designed, we borrowed the dual lens concept from the small classic dedolight. This alone did not prove good enough for the high standards set for this series. We wanted the focusing range that had set apart the classic dedolight system from other lights. We also wanted a distinct clean beam with no stray light for lighting with utmost precision. Within the beam, we also wanted to eliminate hot spots that are typical of other lights. At the same time, it was important to eliminate the color distribution problems that usually plague daylight sources.

It took four years of intensive optical research to solve these problems. The seemingly endless series of computer simulations and prototypes resulted not only in several new patents protecting this new level of technology, but also provides the discerning professional with three outstanding precision tools.

The new triple zoom focus and relation computed double Aspherics² system is common to the:

- dedolight DLH400DT, 400 / 575 W daylight/tungsten version
- dedolight DLH650, 650W halogen light
- dedolight DLH436, 400W / 36V low voltage halogen light

In the professional community, these innovations found enthusiastic response and received both a Scientific and Engineering Award from the Oscar committee and the Emmy statuette from the Academy of Television Arts and Sciences.



DLH400DT Daylight Light Head

A fixture for single ended 400W daylight metal halide lamps with unrivaled focusing range and unequalled light quality. Can be operated at 575 W with the same lamp when used in conjunction with the dedolight DEB400DT electronic ballast. Matches optical design of the DP400 projection attachment for flawless performance.

Technical Data: DLH400DT

Focus Angle: 50°-4.5°
 Focus Intensity: 1 : 20
 Focus Scale: Indicates current angle of beam
 Weight: 4400 g (9.7 lbs)
 Lamp: DL400DHR-NB 400W daylight single ended,
 Hot Restrike
 Cable: DPOW400DT, 7 m (23')
 Mounting: 16 mm (5/8") receptacle and 28 mm (1 1/8") stud
 Safety: Safety switch prevents operation when access door is open
 UV: Extremely low UV emission
 ON/OFF: On/Off push buttons located on both head and ballast for ease of operation

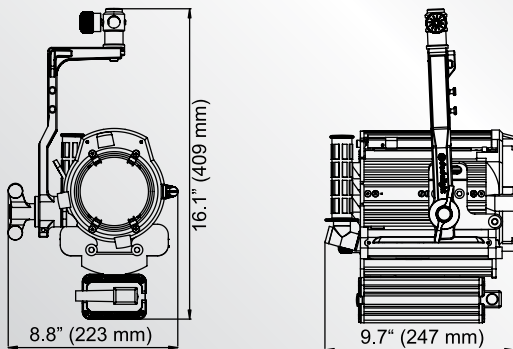

DEB400DT Flicker Free Ballast

Utilizing the latest technology, the DEB400DT electronic flicker free ballast was designed to power the DLH400DT, the dedoPAR and the DLH400SDT.

Light weight yet rugged, small yet powerful with every conceivable feature you would want.

- Dimmable (40%)
- Boost position for added light output (575W)
- Active power factor correction
- Auto start mode on request
- Over voltage, overload, overheat and short circuit protection
- Automatic input voltage adjustment from 90- 260 V AC

Technical Data: DEB400DT

Weight: 3400 g (7.5 lbs)
 Wattage: 400/575 W
 Input voltage: Automatic sensing 90- 260V AC
 Mounting: May be attached to light stand using DEB400H ballast holder (not included)
 Safety: Over voltage, overload, overheat and short circuit protection
 Indicators: Three LED status indicators (ready, lamp, heat)
 Dimming range: 40%

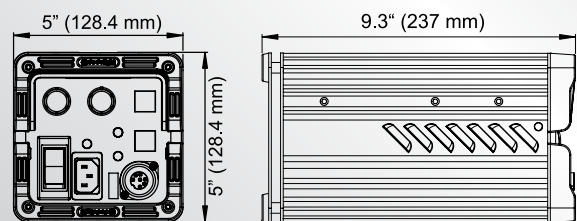



DLH400SDT Daylight Soft Light

A dedicated 400/575W soft light. Works with an amazing variety of soft boxes: dedoflex, Photoflex and Chimera. Two times the light output when compared to any soft box mounted to a Fresnel fixture. Perfectly even light distribution. Works with the proven dedolight DEB400DT ballast (same ballast as for DLH400DT focusing daylight fixture).

Integrated speed ring for dedoflex medium and PanAura®/Octodome 5.

For compatibility with soft boxes/domes of other manufacturers see page 88. For packing see page 37 "soft light packing".

Technical Data: DLH400SDT

Weight: 1575 g (3.4 lbs)
 Lamp: DL400DHR-NB 400W daylight single ended, Hot Restrike
 Cable: DPOW400DT, 7 m (23')
 Mounting: 16 mm (5/8") receptacle and 28 mm (1 1/8") stud
 Safety: Auto cut-off when protective tube missing or damaged
 UV: Protective quartz glass tube with UV-cut function

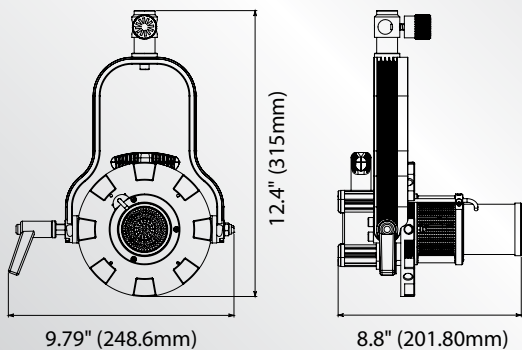

dedolight PanAura®/Octodomes

Both dedolight PanAura®/Octodomes feature huge diffuser areas producing a beautiful, wrap around, soft light.

These PanAura®/Octodomes are extremely flat, making them ideal for work in confined spaces. The light output has to be seen to be believed and the light quality is absolutely stunning!

Several kits are available which utilize the PanAura®/Octodomes.

(See page 65 for detail.)



	DLPA5 (DSBOCT)	DLPA3 (DSBOCTS)
Assembled	150x150x40,5 cm (5'x5'x1.3')	88x88x34,5 cm (2.9'x2.9'x1.1')
Packed	85x20x10 cm (2.7'x7.9'x3.9")	57x20x9 cm (1.9'x7.9'x3.5")
Diffuser	150x150 cm (5'x5')	83x83 cm (2.7'x2.7')
Depth	40,5 cm (1.3')	34,5 cm (1.1')
Weight	1500 g (3.3 lbs)	757 g (1.67 lbs)
Works with lighthead	DLH400SDT DLH1000SPUS DLH4x150S	DLH200SDT
Grid 40°	DLPA5G (DLGRIDDOCT)	DLPA3G (DLGRIDDOCTS)





DLH1000S Tungsten Soft Light

A dedicated single function halogen soft light, exclusively for use with many styles and sizes of soft boxes.

The lamp, which is placed in the focal center of the soft box produces a perfectly lit surface. In comparison to a soft box attachment mounted to a Fresnel fixture, it provides double the light efficiency with no hot spots. Readily available halogen lamps from 500-1000W may be used in this light fixture.

The DLH1000S can be a stand alone light or a companion to the classic tungsten dedolight and Series 400 focusing halogen heads.

A protective glass tube is easily removable for quick lamp change. Many styles and sizes of soft boxes may be used with the integrated speed ring.

Adapts in seconds and without tools to an amazing variety of soft boxes by the function of the innovative variable size speed ring. The diameter is changed by extending the rod receptacles for the soft box in four steps:

130 mm (5.118"), 150 mm (5.9"), 170 mm (6.69") or 190 mm (7.48").

For packing see page 37 ("Soft light packing")

DLH1000SPPLUS Tungsten Soft Light

The DLH1000SPPLUS is a 1000 W halogen soft light similar to the DLH1000S but fitted with a larger mounting yoke which allows the use of larger soft boxes. It features eight receptacles to accept the dedolight PanAura®/Octodome 5.

This light is ideal for drama productions or large sets requiring a broad soft source.

The DLH1000SPPLUS can be used as the tungsten companion to the DLH400SDT daylight version.

When a smaller size or packaging is required, please see DLH1000S.

Features the same adjustable speed ring as DLH1000S.

Diameter changeable in four steps:
150 mm (5.9"), 170 mm (6.69"), 190 mm (7.48") or 210 mm (8.26").

For packing see page 37 ("Soft light packing")

Technical Data: DLH1000S

Weight: 800 g (1.8 lbs)
Lamp: See lamp table below
Cable length: 3 m (9.8')
Mounting: 16 mm (5/8") two axis receptacle and 28 mm (1 1/8") stud
Safety: Protective glass tube
ON/OFF: In-line switch
Socket: G9.5

Technical Data: DLH1000SPPLUS

Weight: 1200 g (2.6 lbs)
Lamp: See lamp table below
Cable length: 3 m (9.8')
Mounting: 16 mm (5/8") two axis receptacle and 28 mm (1 1/8") stud
Safety: Protective glass tube
ON/OFF: In-line switch
Socket: G9.5

Technical Drawing: DLH1000S

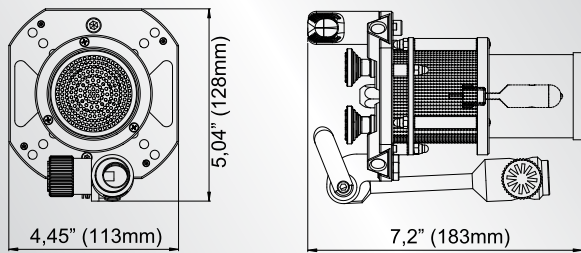

Technical Drawing: DLH1000SPUS

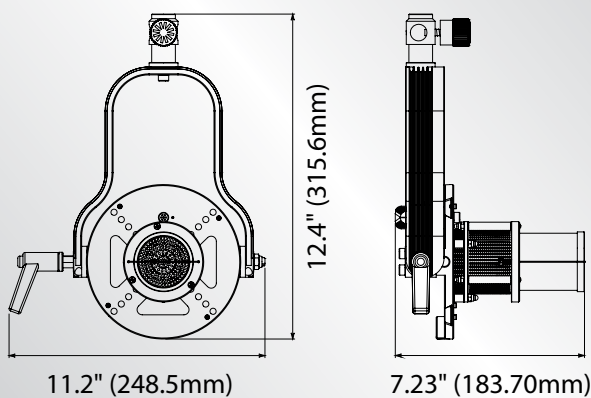

Soft Boxes and Grids

All dedolight soft lights are dedicated, single purpose lights (with the exception of the dedoPAR system). Our soft lights place the actual light source in the focal center of the soft box, optimizing output and providing even light distribution on the diffuser with no hot spots.



- DSBSXS** dedoflex Mini soft box silver, 30x30 cm (12x9"), depth 23 cm (9")
- DSBSS** dedoflex Silver Dome, small 41 x 56 cm (16x22"), depth 33 cm (13")
- DSBWS** dedoflex White Dome, small 41 x 56 cm (16x22"), depth 33 cm (13")
- DSBSM** dedoflex Silver Dome, medium 61 x 81 cm (24x32"), depth 43 cm (17")
- DSBWM** dedoflex White Dome, medium 61 x 81 cm (24x32"), depth 43 cm (17")
- DLPA5 (DSBOCT)** PanAura®/Octodome 5, 150 cm (5') diameter, only 40.5 cm (16") deep. Weight: 1500 g (3.3 lbs)
- DLPA3 (DSBOCTS)** PanAura®/Octodome 3, 83 cm (2.7') diameter, only 34,5 cm (13,6") deep. Weight: 757 g (1.67 lbs)
- DLGRIDXS** Mini grid, fits Mini soft box, limits angle to 40°
- DLGRIDS** Grid small, fits small Silver Dome, limits angle to 40°
- DLGRIDM** Grid medium, fits medium Silver Dome, limits angle to 40°
- DLPA5G (DLGRIDOC)** PanAura®/Octodome 5 Grid, limits angle to 40°
- DLPA3G (DLGRIDOC)** PanAura®/Octodome 3 Grid, limits angle to 40°
- DLSR70** Mini speed ring for Mini soft box, fits DLH4, DLHM4-300, and DLH200DT

All above combinations are direct attachment with no speed ring required. Mini soft box also fits DLH4, DLHM4-300 and DLH200DT light heads with mini speed ring DLSR70.

[●] 800 W max

Lamp Choices for dedolight DLH1000S and DLH1000SPUS Tungsten Soft Light

Max. lamp wattage with small soft box – 800W

Max. lamp wattage with larger size soft boxes – 1000W

ANSI	W	V	K	Average Lifetime (h)	lumen
DL1000FEP	1000	230	3200	300	25000
DL1000FEP	1000	240	3200	300	25000
DL1000FEL	1000	120	3200	300	27500
DL800HX	800	230	3200	250	20000
DL800HX	800	240	3200	250	20000
DL750EHF	750	120	3200	300	20000
DL600GKV	600	230	3200	250	14000
DL600GKV	600	240	3200	250	14000
DL500EHC	500	120	3150	500	12700

	DLH1x150S	DLH1x300S	DLH4x150S	DLH1000S	DLH1000SPUS	DLH200SDT	DLH400SDT	DPAR-S	DLH200DT	DLH4	DLHM4-300
Tungsten	●	●	●	●	●	●	●	●	●	●	●
Daylight						●	●	●	●		
Mini	●	●							●	●	●
Small silver	●	●		[●]	[●]	●	●				
Small white		●		[●]	[●]	●	●				
Medium silver	●	●	●	●	●	●	●	●			
Medium white		●		●	●	●	●	●			
PanAura®/Octodome 5			●		●		●	●			
PanAura®/Octodome 3						●					



dedoPAR Daylight

The dedoPAR is a 575/400 W PAR light head which operates with the same dedolight DEB400DT electronic ballast as used with the DLH400DT daylight focusing light head and DLH400SDT daylight soft light.

The light head is fitted with push buttons so that it can be started from the light head as well as from the ballast (similar to the operation of the dedolight DLH400DT light head).

The dedoPAR can be used in two different configurations:

- I. As a PAR light (see page 23)
- II. Die Softlight-Variante (Direct/Soft) (see page 23)

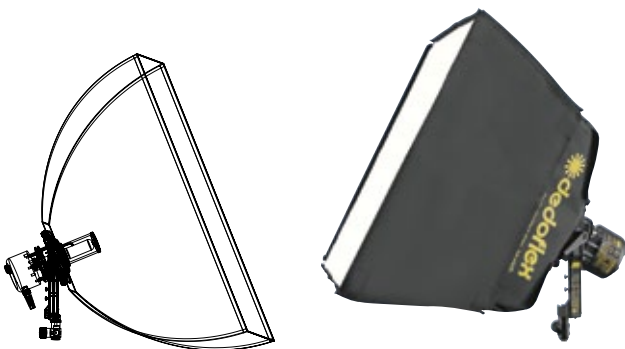

Components

- | | |
|---|---|
| <ul style="list-style-type: none"> 1 DPAR-O 2 DPAR-R 3 DLSR2 4 DPARD1 5 DPARD2 6 DPARD3 7 DPARBD 8 DPAR-S 9 DLSR1 10 DLSR8 11 DSBSM 12 DPOW400DT 13 DEB400DT 14 DL400DHR-NB 15 DCPAR | <p>dedoPAR base unit light head to be combined with DPAR-S or DPAR-R.</p> <p>dedoPAR reflector with yoke.</p> <p>dedolight speed ring (Ø 160 mm) for soft boxes of other brands. (see page 89 for details).</p> <p>Spread lens (Flood).</p> <p>Spread lens (Medium).</p> <p>Spread lens (Spot).</p> <p>Barn door.</p> <p>Direct/Soft attachment with yoke (speed rings from dedoflex, Chimera and Photoflex are attachable, see page 88, 89).</p> <p>dedolight speed ring (Ø 119 mm) for dedoflex silver and white domes medium (see page 88).</p> <p>dedolight speed ring (Ø 119 mm) with 8 rod receptors for PanAura®/Octodome 5.</p> <p>dedoflex silver dome medium. Can be replaced by dedoflex white dome medium (see page 88 for details).</p> <p>Light head to ballast power cable (7 m).</p> <p>Electronic ballast with mains cable (same as for dedolight DLH400DT).</p> <p>400/575 W daylight lamp (clear).</p> <p>Transport case for dedoPAR, direct/soft attachment, lens set, barn door and ballast.</p> |
|---|---|

See dedoPAR kits on page 67.



I. As a PAR light

The PAR light version shows high light efficiency due to good reflector design and a focusing control. The light head without a diffusion lens will give you high light output, but you will experience fairly useable light distribution only in one focusing position for any given distance. As with other PAR lights, the beam can be modified with the use of three interchangeable lenses.

II. As a Soft Light (Direct/Soft)

The front part (reflector) of the dedoPAR can be replaced with the Direct/Soft attachment. The removable and rotatable speed ring accepts dedoflex small and medium silver and white domes as well as dedolight PanAura®/Octodome 5 and many Chimera and Photoflex soft boxes. This attachment is fitted with a quartz glass tube which serves as a very efficient UV-cut filter. A safety switch is included, which will shut down the light if the protective glass filter tube is missing or damaged.

Technical Data: dedoPAR

Weight:	DPAR-O – 1000 g (2.2 lbs) DPAR-R – 1900 g (4.2 lbs) DPAR-S – 900 g (2 lbs)
Lamp:	DL400DHR-NB 400 W daylight single ended, Hot Restrike
Cable:	DPOW400DT, 7 m (23')
Mounting:	16 mm (5/8") receptacle and 28 mm (1 1/8") stud
Safety:	Auto cut-off when protective glass is missing or damaged
UV:	Protective quartz glass with UV-Cut function
ON/OFF:	On / Off push buttons located on both head and ballast for ease of operation

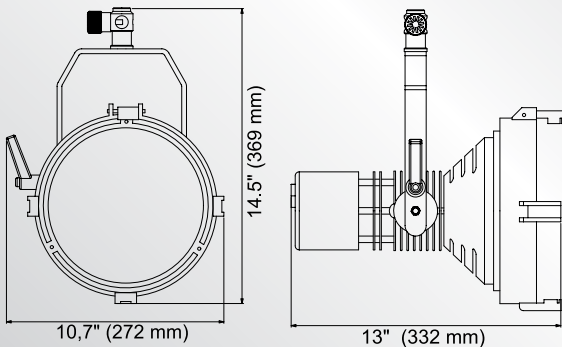

Technical Data: Direct/Soft

Weight:	DPAR-S – 900 g (2 lbs) DPAR-O – 1000 g (2.2 lbs)
Lamp:	DL400DHR-NB 400 W daylight, single ended, Hot Restrike
Cable:	DPOW400DT, 7 m (23')
Mounting:	16 mm (5/8") receptacle and 28 mm (1 1/8") stud
Safety:	Auto cut-off when protective tube is missing or damaged
UV:	Protective quartz glass tube with UV-Cut function
ON/OFF:	On / Off push buttons located on both head and ballast for ease of operation

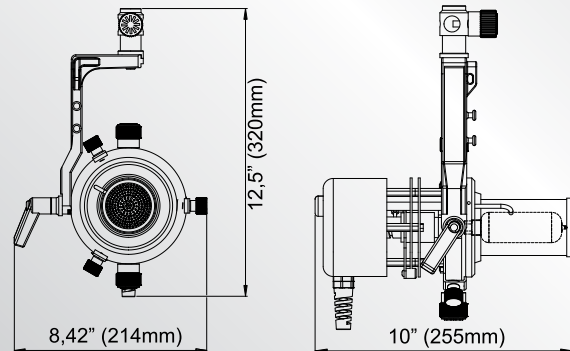

SERIES 400



DLH650 Tungsten Light Head

A mains operated tungsten light with unrivaled focusing range and superior light quality.

Can be used with a choice of 650W, 500W or 300W halogen lamps in versions from 100-240V.

Option: available with additional DMX electronic (DLH650DMX).

DLH650PO Pole Operated Tungsten Light Head

For hanging application in studios. Pan, tilt and focus are operated by pole. All other features are identical with DLH650.

Option: available with additional DMX electronic (DLH650PO-DMX).

Technical Data: DLH650

Focus Angle: 56°-8°
 Focus Intensity: 1 : 13
 Focus Scale: Indicates current angle of beam
 Weight: 3400g (7.5 lbs)
 Wattage: 300W, 500W, 650W
 Voltage: 100 V, 120V, 230V, 240V
 Cable length: 5 m, (16.4')
 Mounting: 16 mm (5/8") receptacle and 28 mm (1 1/8") stud
 Tilt control: Tilt pivot at center-of-gravity provides excellent balance. Permanent friction and positive locking

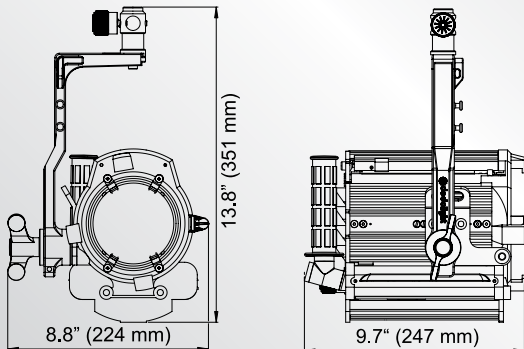

Technical Data: DLH650PO

Focus Angle: 56°-8°
 Focus Intensity: 1 : 13
 Focus Scale: Indicates current angle of beam.
 Weight: 4700g (10.4 lbs)
 Wattage: 300W, 500W, 650W
 Voltage: 100V, 120V, 230V, 240V
 Cable length: 5 m, (16.4')
 Mounting: 16 mm (5/8") receptacle and 28 mm (1 1/8") stud
 Tilt control: Tilt pivot at center-of-gravity provides excellent balance

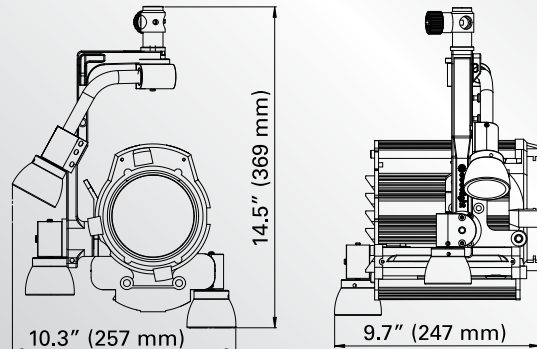



DLH436 Tungsten Light Head

A low voltage fixture for 400W / 36V halogen lamps. Unique light character favored by many DoPs such as Nigel Stone (Harry Potter, V for Vendetta). Total light output exceeds anything remotely close to the 436 in fixture size and operating characteristics.

Requires DT36-1 power supply/control unit.



DT36-1 Power Supply/Control Unit

The DT36-1 power supply / control unit powers one dedolight DLH436 light head.

With the aid of the built in voltage indicator, the input voltage may be set from 100-255V AC (in 5V steps) to precisely match the local prevailing AC power. Three calibrated color temperatures may also be selected.

Technical Data: DLH436

Focus Angle:	56°-5.5°
Focus Intensity:	1 : 16
Focus Scale:	Indicates current angle of beam
Weight:	3400g (7.5 lbs)
Wattage:	400W
Voltage:	36V
Cable:	DPOW436, 8 m (26.2')
Mounting:	16 mm (5/8") receptacle and 28 mm (1 1/8") stud
Tilt control:	Tilt pivot at center-of-gravity provides excellent balance. Permanent friction and positive locking

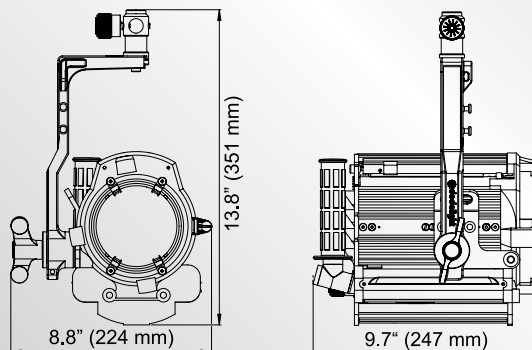

Technical Data: DT36-1

Weight:	6200g (13.7 lbs)
Input voltage:	100-255V AC
Output voltage:	1 x 36 V AC / 400W
Controls:	Input voltage control indicator, switchable output for color temperature/intensity, fused input and output

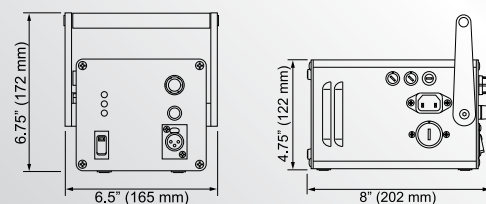

SERIES 400 ACCESSORIES

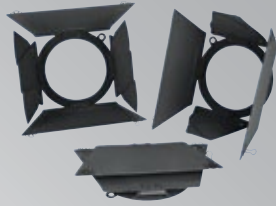

DBD400

DBD400 Eight leaf barn door. Each large leaf has two clips to hold gel filters.
Weight: 150 g (5.3 oz)



DFH400

DFH400 Gel filter holder
Constructed out of two metal frames which slide inside each other. Accepts any type of heat resistant gel filter.
Size: 12.8 x 12.8 cm (5 x 5")
Weight: 22 g (0.7 oz)



DGRADF400

DGRADF400 Graduated neutral gray glass filter with dichroic coating

Soft edge transition from clear glass to neutral gray, available in three densities. NDO3 (one stop), NDO6 (two stops), NDO9 (three stops). Great help in smoothing light distribution when lighting from an angle. Weight: 96 g (3.4 oz.)



DPLS400

DPLS400 Light shield ring
Prevents stray light from exiting light head when no filter accessory is used. Weight: 43 g (1.5 oz.)

DTCF400



DDCF400

DTCF400 Dichroic tungsten conversion filter
Weight: 86 g (3 oz.)

DDCF400 Dichroic daylight conversion filter
Weight: 99 g (3.5 oz.)



DLSW1000

DLSW1000 1000 W Inverter
Allows powering the DEB400DT electronic ballast from a car battery or other 12 V DC source.
Size: 35 x 20.5 x 11 cm (13.8 x 8.1 x 4.3")
Weight: 6.5 kg (14.3 lbs)

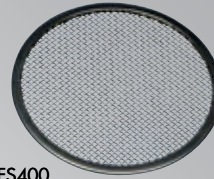

DSCFS400

Scrim

DSCFS400 Full scrim, single
Light reduction of 25% (1/2 stop)



DSCFD400

DSCFD400 Full scrim, double
Light reduction 50% (1 stop)



DSCG400

DSCS1/2-400 Half scrim, single
Covers only 1/2 of light exit. Reduces light for half angle of beam. 360° rotatable.

DSCD1/2-400 Half scrim, double

DSCG400 Graduated scrim

DSCK400 Scrim kit

Includes DSCFS400, DSCFD400, DSCS1/2-400, DSCD1/2-400, DSCG400



DPACP400

Pouches

DPACP400 Imager accessory pouch
Four compartments for gobos, scrims, filters, framing shutters, etc.

DSCP400 Scrim pouch
Pouch for scrims and filter holders.



DSCGP400

DSCGP400 Scrim pouch
Pouch for scrims, filter holders and precut gel filters.

Mounting



DEB400H

DEB400H Mounting bracket with clamp
For mounting DEB400DT electronic ballast to lighting stand.
Weight: 138 g



DST400

DST400 dedolight stackable stand
Height: collapsed 107 cm (3.5'), max. 366 cm (12'), Weight: 2.1 kg (4,6 lbs)

DST400S dedolight stackable stand
PanAura®/Octodome 5 soft case.
Height: collapsed 86 cm (2.8'), max 237 cm (7.7')
Weight: 1.2 kg (2.65 lbs)

SERIES 400 IMAGER



A modular optical system of unprecedented quality and versatility.

The Series 400 Imager has become a successful tool for demanding precision lighting. Not only ideal for special effects from large, high precision projections, but also perfect all the way down to tiny accents.

Whenever light and shadow patterns, or gobo projections with razor sharp edges are needed, the Series 400 Imager allows for perfect contrast, high resolution and high light efficiency. A unique image plane adjustment provides edge-to-edge sharp images even for off axis use.

Whatever your creativity calls for, the Imager does it all without color fringing, distortion, or fuzzy resolution, all of which often plague other systems.

- High precision image projection
- Precise light and shadow shapes
- Extremely sharp – high resolution
- No color fringing, no halation
- Perfect contrast rendition



SERIES 400 IMAGER

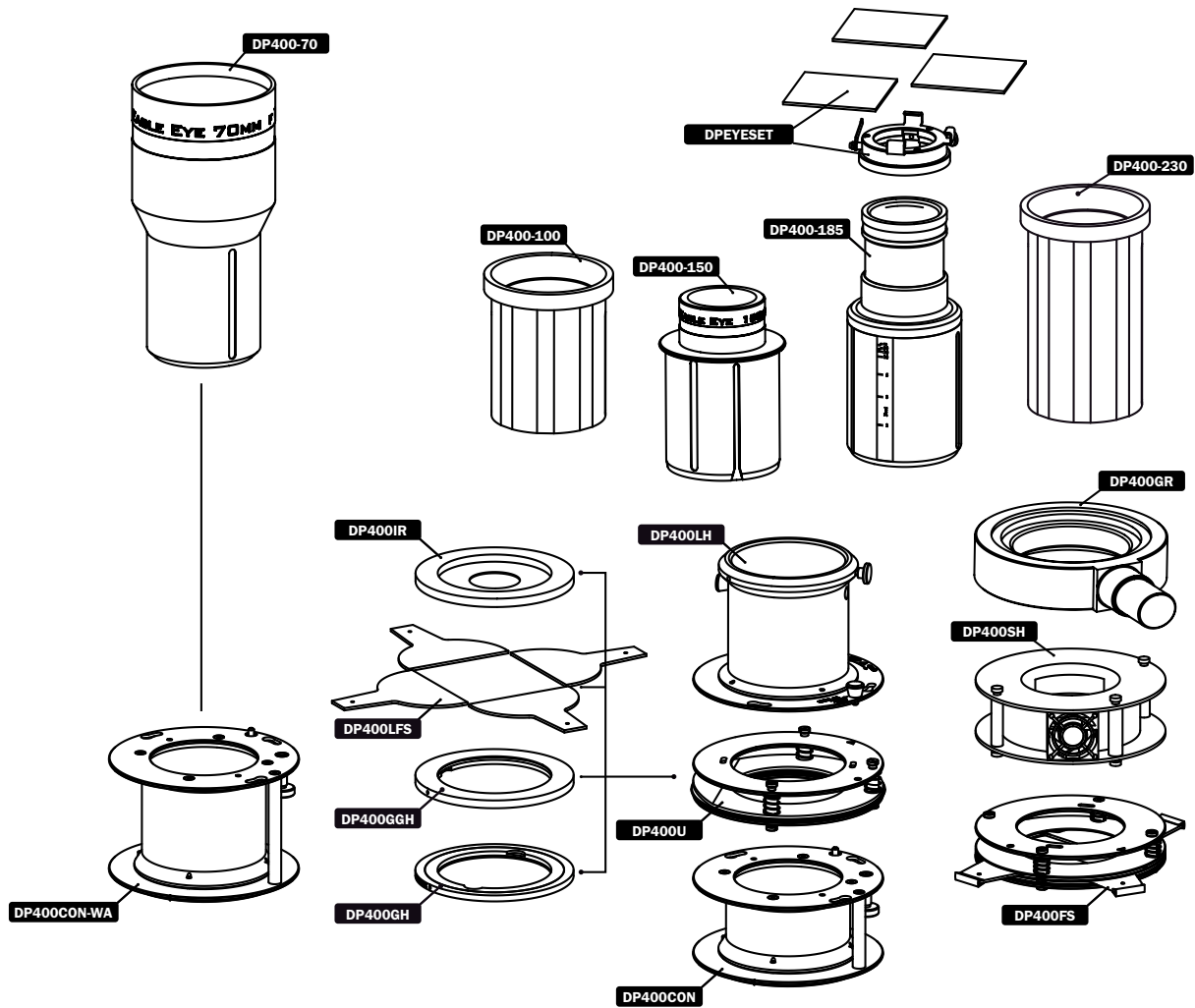

The Imager 400

The DP400 projection attachment is a modular system enabling quick change and versatility. Two basic configurations are available, and due to the sophisticated modular system, additional components may be easily added according to the users application.

DP400KU Imager set with universal receptacle.

Set consisting of:

- DP400CON
- DP400LH
- DP400-185
- DP400U

DP400KFS Imager set with framing shutter assembly.

As described above, but with DP400FS, framing shutter module with four non-re-movable, built-in framing shutter leaves in place of the DP400U, universal receptacle.

Set Components

DP400CON Condenser

For DP400 lenses 100-230 mm focal length. The standard back part of the projection attachment includes a two lens condenser system, one of which is an aspherical lens. An image plane adjustment control is provided so that projections from an off-angle position may be focus corrected. A safety cable attachment point is also provided.

Weight: 704 g (1.5 lbs)

DP400CON-WA

Wide angle condenser required for DP400, 70 and 100 mm focal length lenses. Weight: 2150 g (4.7 oz.)

DP400U Universal receptacle

Weight: 350 g (12.4 oz.)

Accepts the following optional accessories:

- DP400GGH Glass gobo holder
- DP400GH Steel gobo holder
- DP400LFS
Loose shutter leaves (set of four)
- DP400IR Iris (18 leaves)

DP400LFS

Framing shutter, loose leaf set
Consisting of four framing shutter
leaves, which can be used on
their own or together with a gobo
holder to cut the projected image
to a desired size.
Weight: 60g (2.1 oz.)

PLEASE NOTE:

If you want to use the framing
shutter leaves only, we recom-
mend the use of the **DP400FS**
accessory with non-removable,
built in shutter leaves. Easier
to use as leaves move on two
planes without touching each
other.

DP400FS

Framing shutter assembly
The four non-removable, built-in
shutter leaves move in two planes
allowing movement of one shutter
leaf without moving other shutter
leaves.
Weight: 155g (5.4 oz.)

DP400FSF

Framing shutter assembly
Similar to **DP400FS** but with
extra slot for gel filters (gel filter
holder included).
Weight: 410g (14.5 oz.)

DP400FH

Extra filter holder for DP400FSF
Weight: 22g (0.7 oz.)

DP400IR

With 18 leaves.
Weight: 200g (7 oz.)

DP400GH

Holds a single steel gobo,
Size A, Ø 100mm, image
max. Ø 75mm.
Weight: 85g (3 oz.)

DP400GGH

Holds a single glass gobo,
Size A, Ø 100mm, image
max. Ø 75mm.
Weight: 100g (3.5 oz.)

DPEYESET

Eye filter attachment
Fits **DP400-185** projection lens
only. Complete with three polycar-
bonate filters and filter holder. Eye
filters soften shadow edge – not a
diffusion filter.
Weight: 96g (3.4 oz.)

DP400LH

Projection lens. holder
Weight: 378g (13.3 oz.)

DP400-70

Projection lens
70mm, f/1.5, high transmission,
seven element projection lens.
High resolution with low distortion.
DP400CON-WA needed.
Weight: 2700g (5.9 lbs)

DP400-100

Projection lens
100mm, f/1.6, high transmission,
six element projection lens. High
resolution with low distortion.
DP400CON-WA recommended.
Weight: 1070g (2.4 lbs)

DP400-150

Projection lens
150mm, f/2.2, high transmission,
four element projection lens. High
resolution with low distortion.
Weight: 650g (1.4 lbs)

DP400-185

Projection lens
185mm, f/3.5, projection lens
with focus scales on both sides
of the barrel (marked in meters
and feet).
Weight: 516g (1.1 lbs)

DP400-230

Projection lens
230mm, f/2.3, high transmission,
six element projection lens.
Weight: 2222g (4.9 lbs)

DP400SH

Slide holder attachment
For 6x6cm (2 1/4" x 2 1/4")
slides. Attachment includes a
high quality heat-reflecting filter,
fan and power supply. Lifetime
of slide depends on type of
dedolight and lamp used. When
used with light source at maximum
intensity, discoloration of slide
may become noticeable after
approximately 50 hrs.
Weight: 634g (1.4 lbs)

DP400SHA

Slide holder attachment
Similar to **DP400SH** but with
image plane adjustment (any
direction) to maintain sharp focus
for off-axis projections up to
approx. 45° (depends on focal
length of lens).
Weight: 580g (1.3 lbs)

DP4002GR

Gobo rotator
Gobo rotator for two steel gobos.
Rotation, concentric working in
opposite directions. Including
multispeed power supply 3-12V.
Weight: 740g (1.6 lbs)

DP4002GR+

Gobo rotator
Similar to **DP4002GR** but with
built in fan and heat reflecting
filter for use with two gelprinted
effect gobos. With second power
supply for fan (24V).
Weight: 780g (1.7 lbs)

DP400G

Standard steel gobo
More than 300 different shadow
patterns available. Size A,
Ø 100mm, image
max. Ø 75mm.

DP400GC

Custom-made
steel gobo from customers
artwork.
Size, same as above.

DP400GG

Glass gobo.
Available in multicolor or single
color, black and white.
Custom-made glass gobos also
available (**DP400GGC**).

*(For more information on gobos
see page 50.)*

DPACP400

Accessory pouch
With four compartments for
gobos, iris, framing shutter blades.





Four light sources in a family of two

- Precision focusing
- Smooth soft light
- Daylight metal halide
- Tungsten ceramic

Many lighting situations demand both focusing and soft light sources at the same time. At dedolight, we feel strongly about designing and recommending totally dedicated light sources.

The focusing dedolight DLH2000DT with patented double Aspherics² technology and zoom focus movement provides outstanding capabilities.

The dedolight DLH2000SDT is a dedicated soft light and offers unique qualities for this type of light source. Our light sources are capable of both daylight and tungsten operation.

The DLH2000DT offers two methods of converting from daylight to tungsten:

- Drop in a dichroic tungsten conversion filter – quick, but loss in intensity.
- Install a tungsten balanced ceramic lamp and easily convert from daylight to tungsten with no loss in light output.

The special tungsten ceramic lamp developed for the dedolight system is driven by the same ballast as the daylight lamp. They provide four times the light output of a regular tungsten lamp of the same wattage, have a high color rendition index, and use the same working voltage and flicker free frequency as our daylight lamps.



DLH200DT Sundance Daylight / Tungsten Light Head

The DLH200DT employs our patented double Aspherics² optical system in combination with a zoom focus system. Clearly defined "clean beam", no stray light. It can be converted to tungsten by change of lamp. The tungsten ceramic lamp has four times the light output of traditional tungsten lamps.

Versatility: All projection attachments and accessories of the dedolight 100/150 classic series are compatible with the DLH200DT.



DLH200SDT Sundance Daylight / Tungsten Soft Light

Single function light head exclusively for use with four different types of soft boxes and PanAura®/Octodome 3 (DSBOCTS). Since the actual light source is placed in the focal center of the soft box, the light output is approximately two times the light output in comparison to a soft box mounted on the front of a Fresnel light.

A hot spot is normally encountered when using a soft box on a Fresnel light. The light distribution of the DLH200SDT with all the mentioned soft boxes is perfectly even and homogenous.

For packing see page 37 ("Soft light packing"). For compatibility with soft boxes/domes from dedoflex and other manufacturers see page 88.

Technical Data: DLH200DT

Focus Angle:	48°-4.5°
Focus Intensity:	1 : 14
Weight:	1300g (2.8 lbs)
Lamp:	DL200DHR-NB daylight, DL200THR-NB tungsten ceramic
Dimming:	200W-100W (daylight) 200W-125W (tungsten ceramic) (no noticeable change in color)
Safety:	IP23 – rainproof
UV:	Double UV Protection,

LOWEST UV CONTENT OF ANY COMPARABLE LIGHT SOURCE.

Cable:	DPOW200DT, 7 m (23')
Mounting:	16 mm (5/8") receptacle

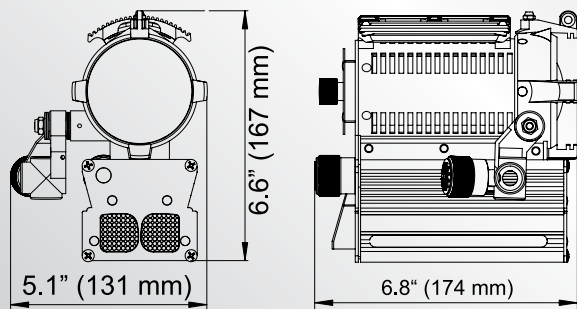

Technical Data: DLH200SDT

Weight:	1500g (3.3 lbs)
Lamp:	DL200DHR-NB daylight, DL200THR-NB tungsten ceramic
Dimming:	200W-100W (daylight) 200W-125W (tungsten ceramic) (no noticeable change in color)
UV:	Double UV protection
Cable:	DPOW200DT, 7 m (23')
Mounting:	16 mm (5/8") receptacle

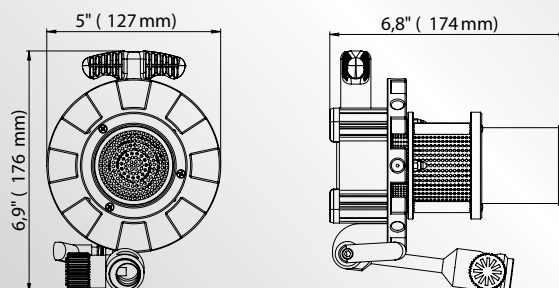

SERIES 200 SUNDANCE



DEB200DT Flicker Free Ballast

Utilizing the latest technology, the DEB200DT electronic flicker free ballasts are designed to power the dedolight DLH200DT and DLH200SDT daylight / tungsten light heads. Light-weight yet rugged, small yet powerful with every conceivable feature you would want. Four different versions allow powering the light from mains or from battery.

- Dimmable from 200 W to 100 W
- Over-voltage, overload, overheat and short circuit protection. Rainproof according to IP 23 when in horizontal position.

Technical Data: DEB200DT

Powered from mains.
 Dimension: 24.0x12.9x7.5 cm (9.5x5x3")
 Weight: 1900 g (4.2 lbs)
 Input Voltage: Automatic sensing 90-260 V AC

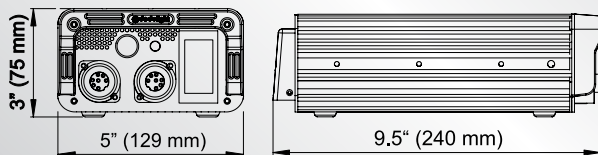

DEB200H
 Mounting bracket for mounting DEB200DT electronic ballast to lighting stand. Works with CLAMP-C (included).
 Weight: 205 g (7.2 oz.)



DEB200DT-BAT
 Battery operated electronic ballast for use with external batteries.
(BIGPACK1, p. 42)
 Input: 21.5-33 V DC
 Dimension: same as DEB200DT
 Weight: 2000 g (4.4 lbs)



DEB200DT-BATAB
 Same as DEB200DT-BAT.
 Fitted with two gold mount plates to simultaneously accept two Anton/Bauer batteries.
 Dimension: 23.8x12.8x9.2 cm (9.4x5x3.6")
 Weight: 2200 g (4.8 lbs)



DEB200DT-BATPAG
(not shown)
 Same as DEB200DT-BATAB but fitted with two mounting plates for PAG batteries.

BIGPACK1
 Ni/MH Battery Pack *(see page 42 for details)*
 Two separate outputs: 14.4 V (28 Ah) & 28.8 V (14 Ah)
 Internal overnight charger: Input 84-240 V / 50-60 Hz
 13-14 hrs.
 Dimension: 13.5 cm x 27.5 cm x 18 cm (5.3" x 10.8" x 7.1")
 Weight: 8 kg (17.6 lbs)

DPOW200DT-BAT
 3-pin XLR cable to connect DEB200DT-BAT versions to BIGPACK1.
 Weight: 322 g (11.4 oz.)



DEXTCHG
 Optional external four hour charger.
 Dimension: 189 x 132 x 82 mm (7.4 x 5.2 x 3.2")
 Weight: 650 g (1.4 lbs)



DLSWI300
 Inverter to power a DEB200DT from a car battery or other 12 V DC source.
 Dimension: 20.5 x 12.5 x 10 cm (8.1 x 4.9 x 3.9")
 Weight: 3.6 kg (7.9 lbs)





The Classic Series, A New Generation

Don't let looks deceive you!

While maintaining the integrity of the Classic Series, we have simply made the best even better by adding our patented Double Aspherics² technology. Originally developed for the award winning dedolight Series 400, this breakthrough optical technology with two relation computed aspherical lenses and a zoom focus mechanism allows for smooth and even light distribution in all focus positions, increased focusing range and still uses 12V and 24V low voltage lamps.

The result of this new technology is to take the unique quality of the dedolight one step further. Compared to its predecessor (when used with the new 150W dimming power supply) the output in flood is doubled, and in spot, three times brighter.

Following our new philosophy of "the two faces of light", you will also find new dedicated soft lights in this range. Designed for one purpose only, these soft lights provide optimum and compromise free performance.

Technical Advantages

- Higher light output
- Smoother field of light
- Cleaner spot
- Improved full flood
- Better barn door control
- Improved character of light
- Incredibly small

Technical Specifications

- Two relation computed aspheric lenses
- Larger reflector
- Added relative motion of second lens (zoom focus)
- Shield/baffle integrated in new movement to provide cleaner beam



DLHM4-300 Tungsten Light Head

The self contained dedolight DLHM4-300 works with an integrated electronic power supply combining:

- New dedolight Aspherics² optics
- Drastically improved light output
- 24V / 150W integrated electronic power supply
- Dimmable

For external dimming of 230 / 240 V units, order option SE.
For DMX control, order option DMX.

Available in four different input voltages (four versions):
240V (DLHM4-300E+), 230V (DLHM4-300E),
120V (DLHM4-300U), 100V (DLHM4-300J)

DLH4 Tungsten Light Head

The fourth generation DLH4 light head is the single, best selling professional, precision light source in the world. This new generation incorporates the award winning Aspherics² lens combination and zoom focus.

The many power options and unprecedented range of accessories make it a uniquely versatile instrument.

- New dedolight Aspherics² Optics
- Drastically improved light output

Technical Data: DLHM4-300

Focus angle: 48°-4.5°
Focus intensity: 1 : 25
Weight: 1020g (2.2 lbs)
Max wattage: 150W (24V)
Cable length: 3 m (9.8') USA / 4 m (13.1') EU
ON/OFF: In-line switch
Mounting: To any 16 mm (5/8") stud
Operating position: Any, except upside down

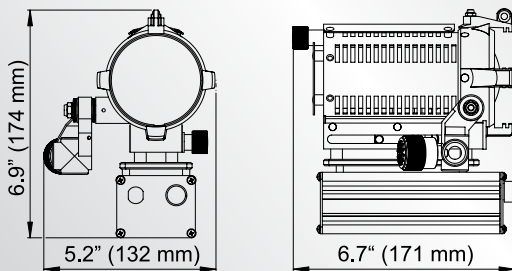

Technical Data: DLH4

Focus angle: 48°-4.5°
Focus intensity: 1 : 25
Weight: 558 g (1.2 lbs)
Max wattage: 100W (12V), 150W (24V)
Cable length: See power options diagram on opposite page
Mounting: To any 16 mm (5/8") stud
Operating position: Any

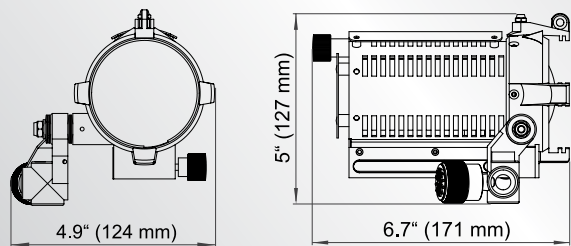



DLH1x150S Tungsten Soft Light

Don't let the small size and low wattage deceive you!

Due to the high light output of the low voltage lamp, it performs well as an interview soft key or fill light.

This soft light uses the same power supplies as the focusing DLH4 light head. When used with a 12 volt lamp it will also work with battery power. See power options on right.

Adjustable speed ring adapts to many soft boxes in seconds:
 Ø 90 mm for dedoflex mini soft box (DSBSXS), Ø 130 mm for small (DSBSS) and for medium (DSBSM) size dedoflex domes should a larger diffusion surface be desired.

For packing see page 37 ("soft light packing").

Technical Data: DLH1x150S

Weight: 600 g (1.3 lbs)
 Max. wattage: 150 W
 Mounting: To any 16 mm (5/8") stud

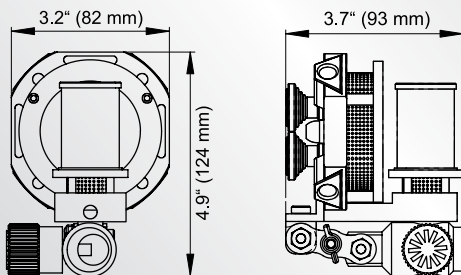

Stromversorgungs-Optionen

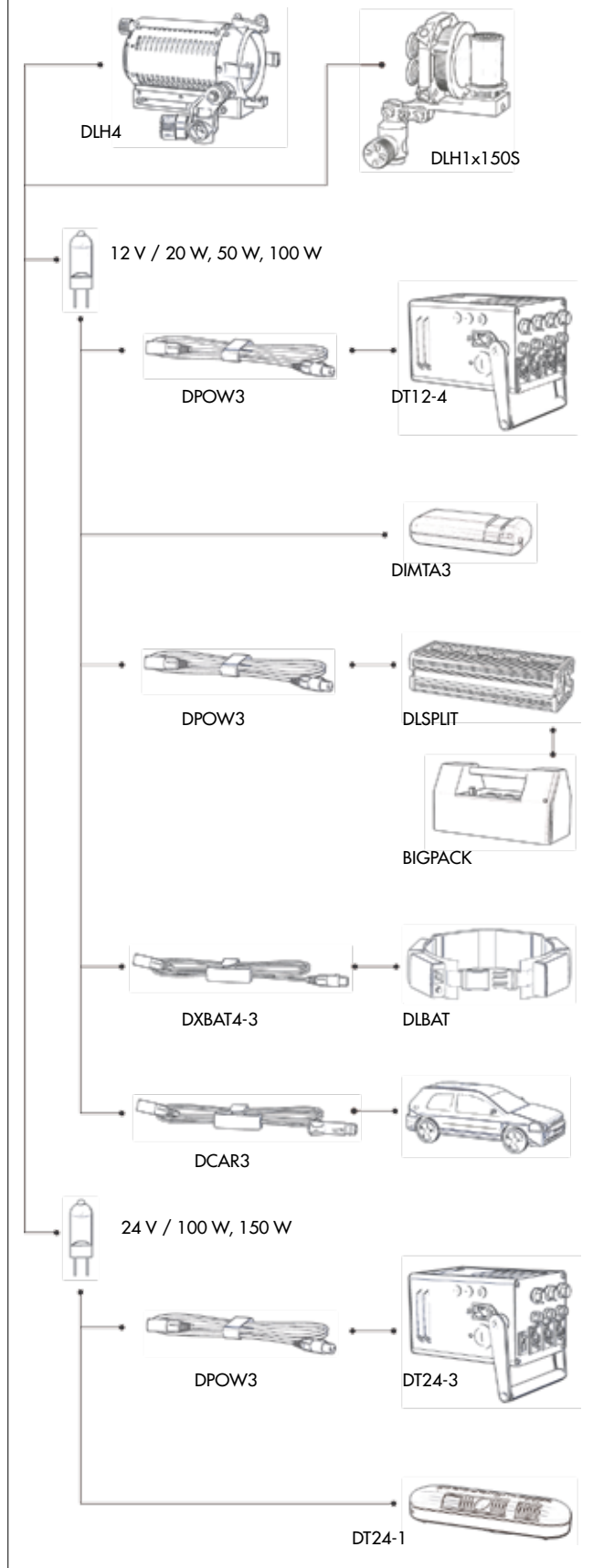



DLH4x150S Tungsten Soft Light

A dedicated soft light for feature films or television series.

This soft light contains four 150W lamps with reflectors in one unit, providing light output just shy of a soft box mounted to the front of a 2K Fresnel. Used with small, medium or large soft boxes, the light level at a given distance remains unchanged even though the size of the diffuser surface changes drastically. The illumination of the diffuser is perfectly even, whether one lamp or all lamps are in operation. Depending on the power option used, the four lamps can be dimmed individually allowing infinite variation of warm tone effects.

This light weight head does not require heavy mounting accessories.

Great versatility of powering options (see page 37).
Requires DT4x150, DT24-3 or DT12-4 power supply.



DT4x150 Power Supply

The DLH4x150S is powered from the DT4x150 control unit which allows individual dimming of each lamp.

Any desired color temperature below 3400K can be chosen. Four different intensity levels can be set for each color temperature by activating one, two, three or four of the lamps. An infinite variation of intensity and warm tone effects can be achieved.

Technical Data: DLH4x150S

Weight:	800 g (1.8 lbs)
Lamp:	Four DL150-NB (24V / 150W)
Cable length:	DPOW4x150 - 2, 2 m (6') (Optional: DPOW4x150 - 8, 8 m, 26')
Mounting:	To any 16 mm (5/8") stud

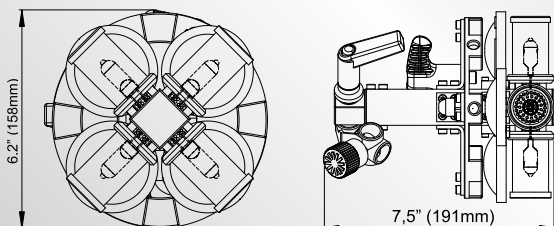

Technical Data: DT4x150

Weight:	2.5 kg (5.5 lbs)
Input voltage:	Available in four different versions: 240V AC (DT4x150E+) 230V AC (DT4x150E) 120V AC (DT4x150U) 100V AC (DT4x150J)
Output voltage:	4 x 24V
Controls:	Each output is individually dimmable

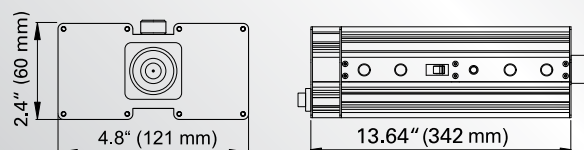



Alternative Power Options for DLH4x150S

DLH4x150S powering is not limited to the DT4x150 power supply. Many other options are possible:

- BIGPACK battery and DLSPLIT dimming splitter box with four lamps at 50W / 12V (see page 42).

If the DPOW4-XLR-2 (2 m / 6') and DPOW4-XLR-8 (8 m / 26') multi conductor cable (shown above) is used, the four lamps of the DLH4x150S may be powered like four individual classic series, dedolight heads. (see "classic power supplies", pages 38 and following for details)

- One DT24-3 (page 39): Three lamps at 150W / 24V. Three calibrated steps of control for each lamp.
- One DT12-4 (page 38): Four lamps at 100W / 12V. Three calibrated steps of control for each lamp.
- Four DT24-1 (page 40) in-line dimmable power supplies. Four 150W / 24V lamps, two calibrated steps for each lamp or individual continuous dimming.
- Four DIMTA3 (page 40) in-line dimmable power supplies. Four 100W / 12V lamps, individual continuous dimming for each light.

Note: Lamp voltage needs to match power supply voltage

Soft light packing

HTP – High temperature pouch
Pouches are made from a space technology textile material (supersil) which can withstand temperatures up to 1100°C (2000°F).

- To pack a hot soft light
- To protect the soft lights glass tube



Available in the following versions:

HTP150S	for DLH1x150S	HTP200S	for DLH200SDT
HTP300S	for DLH1x300S	HTP400S	for DLH400SDT
HTP4x150S	for DLH4x150S		
HTP1000S	for DLH1000S and DLH1000SPUS		



DLH1x300S Tungsten Soft Light

Powerful, small size AC powered 300W soft light, also available as a dimmable version (DLH1x300SDIM).

This travel soft light is ideally suited as an interview soft key or fill light.

Adjustable speed ring adapts to many soft boxes in seconds:
Ø 90 mm for dedoflex mini soft box (DSBSXS),
Ø 130 mm for small (DSBSS) and medium (DSBSM) size dedoflex domes should a larger diffusion surface be desired.

Will adapt to different input voltages by lamp change.

For packing see opposite column ("Soft light packing").

Technical Data: DLH1x300S / DLH1x300SDIM

Weight:	1.38 kg (3 lbs)
Max wattage:	300 W
Mounting:	To any 16 mm (5/8") stud
Cable:	3 m (9.8') with On-Off switch or in-line dimmer

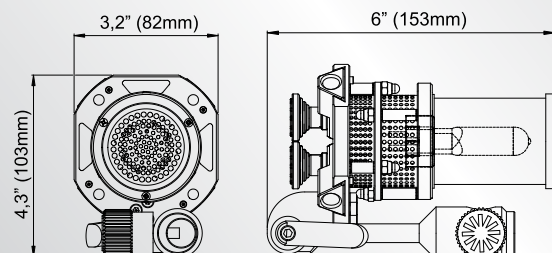

Power Supplies

dedolight low voltage heads using 12V or 24V lamps can be powered from many power sources such as camera batteries, car batteries (directly or via cigarette lighter adapter), battery belts, or any other 12V or 24V AC or DC power source.

Beside its versatility, the dedolight low voltage system also offers several economic advantages (see page 12 for details).

AC current options with 12 V lamps:

- **DT12-4 Power Supply/Control Unit**
Offers four outputs, adjustable to power inputs from 100V to 255V AC, with precise output control in calibrated steps.
- **DIMTA3 in-line electronic power supply (page 40)**
An in-line electronic power supply for countries with 220V-240V AC. Powers one light head and offers continuous dimming.

AC current options with 24 V lamps:

- **DT24-3 Power Supply/Control Unit (page 39)**
Power Supply / Control Unit. Allows powering from 100V to 255V AC, with precise output control in calibrated steps.
- **DT24-1 In-line dimmable electronic power supply (page 40)**
Powers one light head and offers continuous dimming

Options for battery operation:

- **DXBAT4-3 Battery adapter cable (page 39)**
- **DCAR3 Car cigarette lighter adapter (page 39)**
- **BIGPACK BATTERY and DLSPLIT Splitter Box (page 42),**
Powers up to for light heads with 50W/12V each.

A detailed description of these power options follows.



DT12-4 Power Supply

The DT12-4 Power Supply / Control Unit can simultaneously power four classic dedolight heads equipped with 20W, 50W, 100W or mixed wattage lamps. Its AC power input can be set for every AC power in the world from 100-255V AC in 24 steps. Each light output can be individually and independently switched in four distinct steps, each increasing color temperature and output:

- | | |
|-----------|-----------------------|
| 1. Off | |
| 2. Low | 3000K |
| 3. Medium | 3200K (10.7V at lamp) |
| 4. High | 3400K (12.2V at lamp) |

The DT12-4 also incorporates an input voltage indicator allowing the user to determine the correct input voltage setting at a glance and to precisely control the color temperature.

Technical Data: DT12-4

Weight:	5.5 kg (12.1 lbs)
Input voltage:	100-255V AC (switchable)
Output:	4 x 10-12V AC, max. 100W
Controls:	Illuminated master power switch, Fused input and outputs, Switchable input and outputs

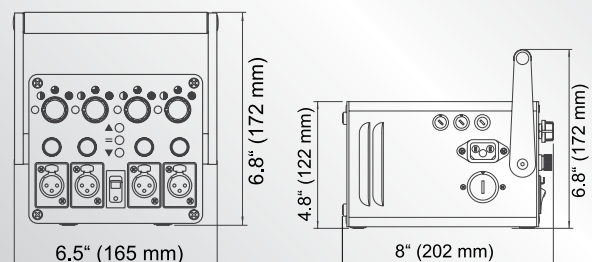



DT24-3 Power Supply

The DT24-3 Power Supply / Control unit can simultaneously power three classic dedolight heads equipped with 150W lamps at a nominal voltage of 24V AC. Its AC power input can be set for every AC power in the world from 100-255V in 24 steps. Each light output can be individually and independently switched in four distinct steps, each increasing color temperature and output.

- 1. Off
- 2. Low 3000K
- 3. Medium 3200K (22V at lamp)
- 4. High 3400K (24V at lamp)

The DT24-3 also incorporates an input voltage indicator allowing the user to determine the correct input voltage setting at a glance and to precisely control the color temperature.

Technical Data: DT24-3

Weight: 5.15 kg (11.4 lbs)
 Input voltage: 100-255V AC (switchable)
 Output: 3 x 17.4-24.5V AC, max. 150W
 Controls: Illuminated master power switch, Fused input and outputs, Switchable input and outputs

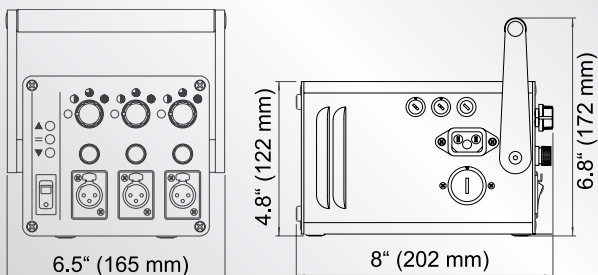

Cables

A complete range of cables is available to meet any power interface need that might arise: 100–255 V AC, 12 V or 24 V DC, camera batteries, automotive batteries, cigarette lighters, in-line dimmable electronic power supplies.

DPOW3 Light head cable



Connects DLH4 light head to DT12-4 or DT24-3 power supply. May also be used as an extension cable. Length: 8 m (26.2')

DXBAT4-3 Battery cable 4-pin XLR



Connects DLH4 light head to any 12V battery with 4-pin XLR connector. Built-in micro fuse. Length: 1.2 m (3.9')

DCAR3 Cigarette lighter adapter



For powering a dedolight DLH4 light head with 12 V lamp from automobile cigarette lighter. The DCAR3 adapter consists of a cable with cigarette lighter plug, in-line on/off switch and mating connector. Length: 2.5 m (8.2')





DT24-1 Power Supply

After several years of development work, we are proud to introduce this new in-line dimmable electronic power supply.

The DT24-1 power supply provides 24V at 150W which results in 80% more light output in comparison to the 12V/100W power supply.



DIMTA3 Power Supply

In-line dimmable electronic power supply.

12V lamps can be used up to 100W. Maximum color temperature is 3200K. Maximum light output is equivalent to medium position on the DT12-4 power supply.

Technical Data: DT24-1

Weight: 710g (1.5lbs)
 Input: Three versions for world wide use
DT24-1E (230 / 240V AC input)
DT24-1U (120V AC input)
DT24-1J (100V AC input)
 Output: 0V-24V / 150W max.
 Controls: Variable function switch for:

- ~ 3400K (maximum output)
- ~ 3200K
- Continuous dimming from maximum to minimum

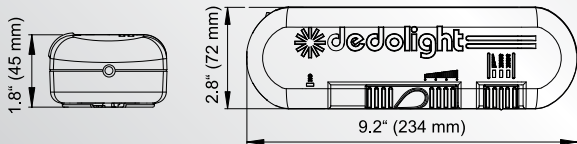

Technical Data: DIMTA3

Weight: 498g (1.1 lbs)
 Input voltage: 230V AC
 Output: 0V - 11V AC / 100W max.

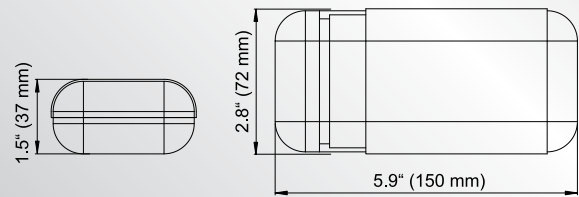



12V Battery Belts

Our battery belts are built from extremely durable textile materials and feature nickel metal hydride cells.

- NiMH (nickel metal hydride) cells with higher capacity. Longer run time for comparable size.

Our battery belts are available in different capacities and all have built-in (5-7 hour) chargers that work with inputs from 84-240V at 50-60 cycle for world wide use.

Options:

- Incorporated electronic discharge guard (add suffix "E")
- With electronic discharge guard and built in dimmer (add suffix "ED")

DLBAT84-2 NiMH cell

12V/10 Ah battery belt with 4-pin XLR connector.
Weight: 2.0 kg (4.4 lbs)

DLBAT84-13 NiMH cell

12V/14 Ah battery belt with 4-pin XLR connector.
Weight: 3.0 kg (6.6 lbs)

Use the **DXBAT4-3** cable to connect battery belts to dedolight DLH4 light head.

Use the **DLOBA2-XLR** cable to connect battery belts to DLOBA² on-board light head.

Technical Data:

Code		DLBAT84-2	DLBAT84-13
Cell type		NiMH	NiMH
Voltage (V)		12	12
Current (Ah)		10	14
Weight (kg)		3.0	3.0
Weight (lb)		6.6	6.6
Run Time (minutes)	100W lamp	50	90
	50W lamp	100	180



Important:

When using the **DLOBA²** on-board light, set the battery belt dimmer to maximum for full light head control and to prevent possible damage to the electronics.





BIGPACK Battery Pack

The BIGPACK will power up to four classic 12V dedolights in conjunction with the dedolight splitter box (**DLSPLIT**) and may also be used to power the Series 200 lights (via the **DEB200DT-BAT**, page 32). Includes internal overnight charger.

The BIGPACK as well as our battery belts feature nickel metal hydride cells.



DLSPLIT Splitter Box

dedolight splitter box to power up to four classic 12V dedolights. Use four 50W or two 100W lights.

May be powered from 14.4V output of **BIGPACK 1**. Each output is individually and continuously dimmable.

BIGPACK runtime examples		
Cell type	2 x 50W / 1 x 100W	4 x 50W / 2 x 100W
NiMH (374 Wh)	224 min.	112 min.

Technical Data: BIGPACK 1

Battery: NiMH
 Two separate outputs: 14.4V (28 Ah) & 28.8V (14 Ah)
 Input voltage: 84-240V / 50-60Hz
 Size: 13.5 cm x 27.5 cm x 18 cm
 (5.3" x 10.8" x 7.1")
 Weight: 8 kg (17.6 lbs)

Technical Data: DLSPLIT

Input voltage: 12-21V DC
 Output: Each regulated to 12V, max. total 200W
 Size: 22 cm x 6 cm x 8.5 cm
 (8.7" x 2.4" x 3.3")
 Weight: 836 g (1.8 lbs)

DPOW200DT-BAT 3-pin XLR cable to connect **DEB200DT-BAT** versions to **BIGPACK 1**.
 Weight: 322 g (11.4 oz.)

DEXTCHG Optional external four hour charger
 Dimension: 189 x 132 x 82 mm (7.4 x 5.2 x 3.2")
 Weight: 650 g (1.4 lbs)



ON-BOARD LIGHTING



Technical Data: DLOBA²

Focus angle:	70°-6°
Focus intensity:	1 : 10
Weight:	558 g (1.2 lbs)
Wattage:	12V/100, 75, 50, 35, 20 W
Input voltage:	10-21 V
Mounting:	Camera shoe or 1/4 screw

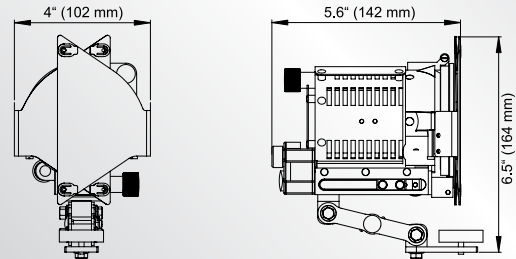

DLOBA² On-Board Tungsten Light Head

The dedolight DLOBA² incorporates a modified Aspherics² optical system. The wide focusing range covers a 70° angle for even edge-to-edge lighting with the widest zoom lenses, yet allows a narrow beam of 6° for far reach (1 : 10).

The DLOBA² may be mounted directly to a film or video camera by the screw and shoe mount that is provided. The software driven miniature electronics regulate lamp voltage to 12V DC and may be used with batteries up to 21V DC.

- Higher light output with less energy consumption
- Soft start to protect recorder operation from start peaks
- Full electronic dimming with no energy loss
- Adjustable support arm allows positioning above, forward and off axis of camera
- Flip-up diffuser for close-up interviews
- Flip-down dichroic daylight conversion filter
- Short circuit protection
- Low voltage switch off to protect batteries from deep discharge
- LED "power available" indicator
- Defective or missing lamp indicator

Cables:

DLOBA ² -AB	for Anton / Bauer output on gold mount plate
DLOBA ² -PAG	to connect to output on PAG system
DLOBA ² -XLR	cable with 4-pin XLR connector for battery belts, battery blocks, etc.



DT12DC Power Supply

The DT12DC allows powering the DLOBA² on-board tungsten light head from mains.

When in continuous use (after approx. 20 min.) the internal cooling fan starts operating. Fan noise may disturb sound recording.

Adapter423
4-pin (male) to 3-pin (female) adapter.

Technical Data: DT12DC

Weight:	970 g (2.1 lbs)
Size:	196 mm x 88 mm x 51 mm (7.7" x 3.4" x 2")
Input:	90-260V AC
Output:	12V DC / 130W
Safety:	Over-voltage and overload protection



dedolight Lamps



The lamps used in the dedolight system offer five distinct advantages.

- Our low voltage lamps offer very high light output up to 40 lumen per watt – much more (double) than high voltage halogen lamps used in conventional studio lights.
- dedolight lamps cost only a fraction of lamps used in standard line voltage lights with similar output.
- The long lifetime (especially of the 12V system) adds further to the savings in operating costs. The savings over time surpass the original purchase price of the entire dedolight light head several times.
- The high durability of the lamps allow dedolights to be used in tough environments. High shock and vibration resistance allows the use of dedolights under conditions which would be practically impossible for fixtures operating on standard voltages.
- The small size of the filament contributes to the effectiveness of the optical system.

for film, TV and photographic work

blackened bulbs for DLH4 and DLHM4-300

Lamp	V	W	Lifetime hours	
			Rated ⁽¹⁾	In dedolight ⁽²⁾ at 3200K
DL20	12	20	3000	3000
DL50	12	50	50	800
DL100	12	100	50	700
DL100-24	24	100	300	800
DL150	24	150	50	300

⁽¹⁾ Manufacturers average rating

⁽²⁾ Average maximum lifetime in dedolight excluding boost position on DT12-4 and DT24-3 power supplies and 3400K position on DT24-1

non-blackened bulbs for DLH1x150S and DLH4x150S

Lamp	V	W	Lifetime hours	
			⁽¹⁾ Rated	⁽²⁾ In dedolight at 3200K
DL100-NB	12	100	50	700
DL100-24-NB	24	100	300	800
DL150-NB	24	150	50	300

⁽¹⁾ Manufacturers average rating

⁽²⁾ Average maximum lifetime in dedolight excluding boost position on DT12-4 and DT24-3 power supplies and 3400K position on DT24-1

DLOB Lamps

New DLOBA² on-board dedolight with electronic voltage regulation will work with DL100, DL75, DL50, DL35 and DL20 lamps resulting in higher output.

100 W lamps (DL100) can be used on DLOBA² lights with serialnumbers # 02000 and higher.

Consult our sales department for lamp selection when using 13.2 or 14.4 V batteries on old non electronic DLOB light heads.



CLASSIC ACCESSORIES



DLWA

DLWA The wide eye is an optical wide angle attachment for classic dedolight and Sundance DLH200DT dedolight. A special negative lens widens the maximum angle from 48° to 80°. Wide angle focusing still possible. Integrated 8 leaf barn door for precision control.

DBD8

DBD8 Standard eight leaf barn door with gel clips. Small leaves have two helper leaves to eliminate unwanted light exit. Each large leaf has two clips for attachment of gel filters. Use of gels (blue, ND, dark colors) with this barn door (instead of filter holder) extends the gel life when used on Aspherics² light heads. Weight: 119 g (4.2 oz.)

DBD2

DBD2 Super barn door. A twelve leaf barn door designed for precision work. A unique patented system which allows individual rotation of each main leaf to create trapezoidal shapes when lighting rectangular objects from off-axis angle. Leaves are 25.4 - 80 mm (1" - 3 1/8") longer than standard to provide better shadow definition. Both smaller leaves are fitted with four spring loaded helper leaves to ensure that no unwanted light escapes. Weight: 169 g (6 oz.)

DPLS

DPLS Light shield ring. Prevents stray light from exiting light head when no filter accessory is used. Weight: 19 g (0.6 oz.)

DFH

DFH Gel filter holder. Accepts any type of heat resistant gel filter. Size: 7,6 x 7,6 cm (3 x 3") Weight: 20 g (0.7 oz.)



DSCFS

DSCFS Full scrim, single. Light reduction of 43% (3/4 stop).

DSCFD

DSCFD Full scrim, double. Light reduction of 55% (~1.2 stops).

DSCD1/2

DSCS1/2 Half scrim, single. Reduces light for approximately half angle of light output. 360° rotatable.

DSCG

DSCD1/2 Half scrim, double

DSCG Graduated scrim. Allows lighting with a gentle blend of three intensities. 360° rotatable.

DSCP

DSCK Scrim kit. Includes DSCFS, DSCFD, DSCS1/2, DSCD1/2 and DSCG.

DPACP

DSCP Scrim pouch. Textile pouch accepts several scrims, with strap to hang on stands and "belt" to store clothespins.

DSCGP

DPACP Accessory pouch. For Imager/Projection attachment, four compartments for gobos, scrims, filters, framing shutters, etc.

DGRADF03, DGRADF06, DGRADF09

DSCGP Gobo, scrim and gel pouch

DGRADF03, DGRADF06, DGRADF09 Graduated, neutral gray glass filters with dichroic coating. Soft edge transition from clear glass to neutral gray, available in three densities. NDO3 (one stop), NDO6 (two stops), NDO9 (three stops). Great help in smoothing light distribution when lighting from an angle.





Gel Filters

Gel filters are available in many different versions and help to achieve a number of different effects.

Sets of individually marked, pre-cut gel filters:

DGB Full blue

Converts 3200K to daylight. Blue gels (DGB) can be used to convert tungsten to daylight or to raise the color temperature of a tungsten light in small steps (DGMB).

DGMB Mixed blue

Full blue (B)
Half blue (1/2)
Quarter blue (1/4)
Eighth blue (1/8)

DGMD Mixed diffusion

Diffusion gels go from a slight spread of the beam (light up to wide-angle spread (white diffusion) and even offer diffusion of the light in only one axis (silk).
Tough frost (TF)
Powder frost (PF)
Light tough frost (LTF)
Tough silk (TS)
Tough white diffusion (TWD)

DGND Neutral density

Neutral density gels (DGND) reduce the light intensity.
ND03 (03)
ND06 (06)
ND09 (09)

DGW Warm tone effect

Dark bastard amber (03)
Pale amber gold (09)
Deep straw (15)
Medium amber (20)
Golden amber (21)

DGCOL Color effect

Canary (312)
Light red (26)
Salmon pink (31)
Deep pink (43)
Deep lavender (58)
Sky blue (68)
Italian blue (370)
Chroma green (389)
Kelly green (94)

DGMO Mixed orange

Full orange (O)
Three-quarter orange (3/4)
Half orange (1/2)
Quarter orange (1/4)
Eighth orange (1/8)

The figures in this table show the quantity of each type of pre-cut gel filters that are included in each package.

DGMB gel packages contain double the quantity of full blue and half the quantity of half blue, quarter blue and eighth blue.

Filter size	7 x 7 cm 2.8" x 2.8"	19 x 22 cm 7.5" x 8.7"	12 x 12 cm 4.7" x 4.7"	28 x 30 cm 11" x 11.8"
DGB	12*	12	-	12
DGMB	8 B/4*	8 B/4	-	4 B/2
DGMD	4	4	4	4
DGND	4*	4	-	4
DGW	4	4	4	4
DGCOL	4	4	-	2
DGMO	-	4	-	2
Use in / with	DFH Classic dedolight filter holder	DBD8 Classic dedolight new barn door	DFH400 Series 400 filter holder	DBD400 Series 400 barn door

* Not recommended for use in the classic dedolights DLH1 – DLH3 with 150W lamp or dedolight DLH4 with Aspherics².

The DLH4 series of Aspherics² light heads provide significantly higher light output which goes along with increased heat output from the front lens. The classic dedolight in generations DLH1 through DLH3 utilized a gel filter holder (DFH) directly in front of the light head.

Some gel filters (blues, ND and darker colors) absorb too much of this added light output and will not provide sufficient gel lifetime. When using these types of gel filters on the DLH4 and DLHM4-300 light heads, use the larger size gels attached by the clips of the DBD8 barn door or attach to a standard barn door by other means.

Order codes for different gel sizes.

- To fit the DFH filter holder (classic dedolight):
no suffix. (example, # **DGMD**)
- To fit the DBD8 (new classic barn door):
add suffix "8". (example, # **DGMD8**)
- To fit the Series 400 filter holder:
add suffix "400". (example, # **DGMD400**)
- To fit the Series 400 barn door:
add suffix "4008". (example, # **DGMD4008**)





Glass Filters

These high-heat resistant glass filters are mounted in a round metal frame (Ø 76 mm, 3") fitted with a plastic handle for safe removal when hot. Filters can be inserted directly into the filter slot of the Classic dedolights and DLH200DT.

DFCOL2

Dichroic color effect filters

The following versions are available:

Red (DFCOL2R)
 Red magenta (DFCOL2RM)
 Full orange (DFCOL2FO)
 Yellow orange (DFCOL2O)
 Yellow (DFCOL2Y)
 Light green (DFCOL2LG)
 Full green (DFCOL2FG)
 Turquoise (DFCOL2T)
 Light blue (DFCOL2LB)
 Medium blue (DFCOL2MB)
 Purple (DFCOL2P)

DCF Daylight conversion filter

This blue glass filter converts 3200 K to approximately 5000 K, and 3400 K to approximately 5500 K. Transmission is approximately 25%. Light loss 2 stops.

DDCF Dichroic daylight conversion filter

Daylight conversion filter for DLH4 and DLHM4-300. Light loss, 1 Stop.

DTCF Tungsten conversion filter

This orange dichroic glass filter converts the light of the DLH200DT from daylight to tungsten (when daylightlamp is used). 5600 K to approximately 3200 K. Light loss, 1 stop.



Reflectors / Diffusers

Collapsible textile reflectors and diffuser discs are available in three versions.

DFT30 Translucent diffuser

Most commonly used with the DLTFH holder as a soft diffuser for enlarging the light source area but can also be used as a soft reflector. Shadows become gentler with subtle transitions.

DFSW30 Silver / White reflector

Offers a choice of using silver side for higher reflection or white side for a more softly diffused reflection.

DFGW30 Soft Gold / White reflector

Soft gold side offers a gentler warm tone reflection, pleasing for skin tones. White side for soft fill light.

Size: Ø 30 cm (12"), Ø collapsed (in pouch) 10 cm (4")
 Weight: 35 g (1.2 oz)

DLTFH dedoflex holder

This holder accepts the 30 cm (12") dedoflex diffuser and reflectors and is mounted between the stand and the light head.
 Weight: 180 g (6.3 oz)





Imager Lenses

The dedolight projection attachment employs interchangeable lenses with different focal lengths to produce various angles and image sizes similar to the way lenses are used on a camera. 60 mm or 85 mm lenses for projecting a larger image.

The 85 mm lens can project an image with a diameter of 135 cm (53") at a distance of 2 m (6-1/2'). The 185 mm lens can project an image with the same diameter (135 cm / 53") at a distance of 5 m (16').

Note: Refer to "Photometrics" on page 93 for additional projection data.

These projection lenses are specifically designed for the dedolight system. They are high quality lenses with metal barrels designed to withstand high heat.

DPL60M 60 mm lens, f / 2.4.
General purpose, wide angle lens.
Weight: 150 g (5.3 oz.)

DPL85M 85 mm lens, f / 2.8.
Standard projection lens. Supplied as standard part of DP1 and DP2.
Weight: 153 g (5.4 oz.)

DPL185M 185 mm lens, f / 3.5.
Has the longest focal length of the dedolight projection lenses.
Weight: 516 g (1.1 lbs)

DPLZ120M 70-120 mm zoom lens, f / 3.5.
Variable focal length lens allowing precise adjustment of image size.
Weight: 516 g (1.1 lbs)

DPLZ150M 85-150 mm zoom lens, f / 3.5.
Variable focal length lens allowing precise adjustment of image size.
Weight: 516 g (1.1 lbs)

DPX Extension tube
Works like a macro extension tube on a camera. Mounts between the projection attachment and projection lens. Extends the projection attachment by 60-100 mm. For projecting light and shadow shapes at short distances and for very small effects.
Weight: 105 g (3.7 oz.)

The Imager

dedolight projection attachments are used to produce defined light and shadow patterns with absolute precision and infinite variations. They fit the front accessory slot of the DLH200DT daylight / tungsten focusing light head and all classic dedolights (except the DLOBA² on-board light).

Because the dedolight and its projection attachment are a uniquely matched optical system, effective output is greater than offered by other fixtures with much higher wattage.

dedolight projection attachments produce a clean shadow, high resolution and sharpness, as well as unrivaled contrast between black shadow and clean light with absolutely no color fringing. Use of interchangeable lenses controls size and intensity allowing working ranges from table top close-ups to longer distances.

Our projection attachments have been used on Fresnel lights of other manufacturers, but unfortunately, with a sacrifice in light efficiency and image quality.





DP1 Imager Projection Attachment

The DP1 Imager offers the greatest versatility with a spring loaded accessory slot to accept a wide range of imaging accessories.

DP1 Universal Imager

Supplied with an 85 mm metal-mounted lens (DPL85M) and soft storage pouch.

Weight: 437 g (15.4 oz.)

DP10 Universal Imager

Same as DP1 but without lens.

Weight: 284 g (10 oz.)

DPFS Framing shutter blades
Supplied in a set of four. You can insert 3, 4 or even 5 of these framing shutter blades to form triangles, squares, rectangles, trapezoids and other shapes.

Weight: 28 g (1 oz.)



DPIR Iris

A fullmetal iris allowing the creation of almost perfectly round images in varying sizes. The standard dedolight iris features a continuous movement of 18 leaves.

Weight: 48 g (1.7 oz.)

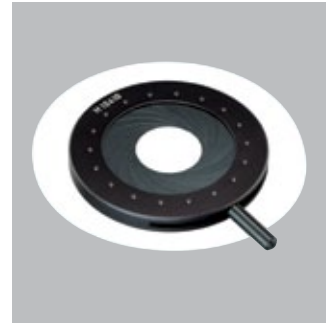

DPGH Gobo holder

A two part holder for round, standard M size Ø 66 mm metal gobos (shadow patterns).

Weight: 22 g (0.8 oz.)

DPGGH Glass gobo holder

A two part holder for round, standard M size Ø 66 mm glass gobos. Will hold 1.75-5.25 mm thick gobo.

Weight: 26 g (0.9 oz.)



DPSH Slide holder

Accepts any mounted 35 mm transparency.

Weight: 45 g (1.6 oz.)

DPACP Accessory pouch for Imager/Projection attachment. Four compartments for gobos, scrims, filters, framing shutters, etc.

Technical Drawing: DP1

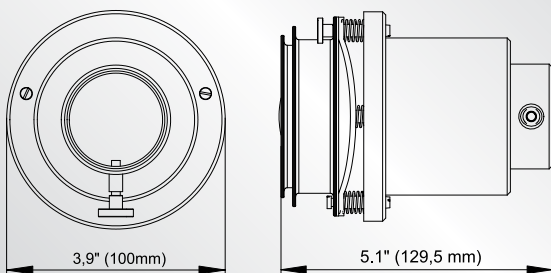

Warning: Use only in conjunction with the dedolight heat filter (DHF).

DHF Heat filter

This glass filter with heat reflective coating, round metal frame and plastic safety handle reduces heat reaching the inserted transparency.

Note: Some temporary loss of effectiveness when used for considerable duration.

Note: When using the DPSH slide holder and DHF heat filter, the maximum lamp watt- age should not exceed 100W. The heat filter will sustain transparency life for short periods. If more light output and longer transparency life is desired, use the DP3 imager with forced aircooling. The DP3 also offers image plane adjustments to maintain edge-to-edge sharp focus when projecting off-axis.



Gobos

Hundreds of standard 'M' size gobo patterns are available to fit the DP1 and DP3 projection attachments. Request a gobo catalog to see available images that include, but are not limited to trees, foliage, clouds, windows, venetian blinds, church windows, floral patterns, snow flakes, sky elements, abstract patterns, city symbols and a wide range of graphic patterns.

DPG Standard gobo

Standard 'M' size, steel, fits classic imager. Requires DPGH gobo holder.

Overall size: Ø 66 mm (2.5"), Image size: Ø 50 mm (2")

DPGC Custom gobo

We also supply custom-made gobos. These are popular for the projection of company logos, product names, store signs, etc. Standard 'M' size, steel, fits classic imager. Requires DPGH gobo holder.

Overall size: Ø 66 mm (2.5"), Image size: Ø 50 mm (2")

DPGG Glass gobo

High resolution glass gobos, size 'M', fits classic imager. Requires DPGGH gobo holder.

Overall size: Ø 66 mm (2.5"), Image size: Ø 50 mm (2")

DPGGC Custom glass gobo

Custom made high resolution multi color glass gobo. These are popular for the projection of company logos, product names, store signs, etc. Standard 'M' size, glass, fits classic imager. Requires DPGGH gobo holder.

Overall size: Ø 66 mm (2.5"), Image size: Ø 50 mm (2")

Hint: Gobo projections add a choice of moods to the setup. Combine with subtle color effects. Throw projected image out of sharp focus to add more depth to the image composition and achieve a "film look" to your video images.

DPGSET Gobo set (6 gobos)

Gobo sets are available in 'M' size for the classic series DP1 and DP3. Gobo sets are a selection of useful patterns which are projected on a background to bring mood to the image and create a feeling of depth. Gobo sets are also available in 'A' size (DPGSET400) for the DP400 imager.

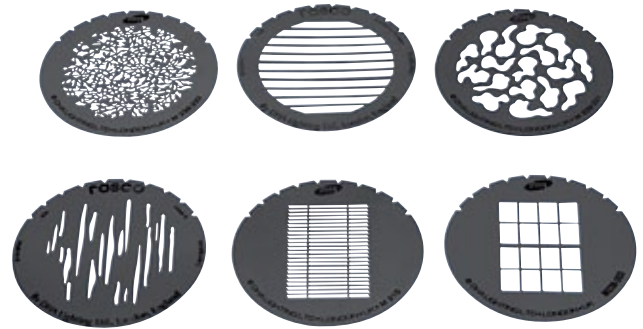



DP2 Imager Projection Attachment

All optical qualities are identical to those of the universal imager (DP1).

The DP2 does not accept other accessories such as an iris, gobo holder or slide holder but is compatible with the DPEYESET (p. 52) eye attachment.

- The four shutter blades are built in and cannot be lost.
- A thin separator disc keeps the four blades from touching each other, eliminating the risk of accidentally moving one blade while manipulating another.
- The DP2 projection attachment was designed especially for gaffers and others who may need to change the projected shape frequently.

DP2 Framing Shutter Imager

Supplied with an 85 mm metal mounted lens (DPL85M) and storage pouch.

Weight: 494 g (1.1 lbs)

DP20 Framing Shutter Imager

Same as DP2 but without lens.

Weight: 340 g (1.2 oz.)



DP3 Imager Projection Attachment

Slide and gobo projection imager with forced air cooling and adjustable image plane. All optical qualities and projection characteristics are identical to those of the universal imager (DP1), including the use of interchangeable lenses for controlling image size and working at different distances.

The DP3 features a built-in multispeed fan with in-line power supply and a high efficiency cooled heat reflecting filter. It allows the use of 35 mm transparencies for prolonged periods even with 150W Aspherics² light heads or the DLH200DT daylight / tungsten focusing light head.

The image plane adjustment allows edge to edge focus even for off axis projections with combined vertical and horizontal correction.

Either framed 35 mm transparencies or M size gobos can be inserted by two individual holders.

DP3 Slide and 'M' size Steel Gobo Imager

Supplied with an 85 mm metal mounted lens (DPL85M) and storage pouch. Includes multispeed 12V power supply for fan.

Weight: 815 g (1.8 lbs)

DP30 Slide and 'M' size Steel Gobo Imager

Same as DP3 but without lens.

Weight: 661 g (1.5 lbs)

Technical Drawing: DP2

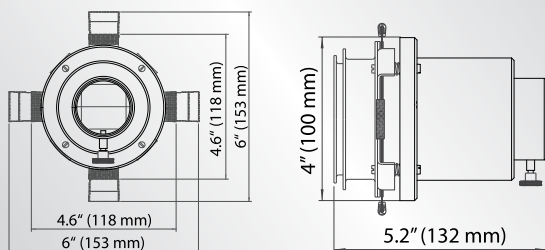

Technical Drawing: DP3

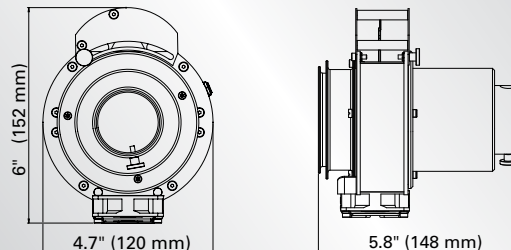



DPEYESET Eye filter attachment

The eye attachment consists of three filters (#1 - #3) and a filter holder which fits all classic Imager projection lenses and the DP400-185 (Imager 400). It can accept one, two or three filters simultaneously, providing seven different variations for softening the shadow edge. Weight: 99 g (3.5 oz.)

The images on this page show only two of many possible uses for the eye attachment and its filters.

DPEYESET Eye Attachment

As long time users of dedolight equipment know, our system never stops growing. Many of the developmental ideas for the dedolight evolved from discussions with directors of photography, lighting designers and gaffers. We welcome your suggestions and challenges.

The novel idea for the eye attachment came from Director of Photography, Julio Macat. Before shooting feature films like "Home Alone," he had worked on many music videos. He loves to highlight the actors' eyes. In the past, he used dedolights with barn doors for this effect. We suggested using the dedolight projection attachment but found that, even when unfocusing the lens, the effect was too harsh. Traditional diffusion materials or various camera filters did not improve the effect.

This gave us the idea of developing special filters for creating soft-edged effects. The purpose being to soften the shadow edge in various degrees without causing a lot of stray light. These new filters are different from traditional diffusion filters.

We now offer three filters:

The weakest filter (#1) just takes the edge off a shadow border. Using the strongest filter (#3) or a combination, one can create a transition so gentle and flowing that the effect is no longer obvious. What remains is a beautifully glowing effect. We have called this filter set "Julio's Eyes" because of its history.

This innovation has become a unique and very helpful tool when shooting commercials, product photography, tabletops and many other subjects.

The effect of these three filters can be fine tuned by the focusing range of the projection lens.

An additional variation is achieved by focusing the dedolight head itself.

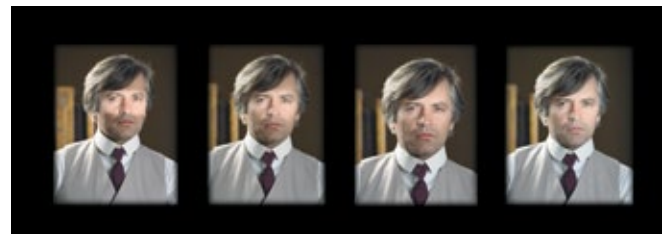

DPEYEP Pouch for DPEYESET attachment and three filters.



CLASSIC MOUNTING

The wide range of mounting accessories are an important part of the dedolight system. In feature films and documentaries, gaffers often need to mount dedolight heads in concealed positions so that the camera's view is neither obscured nor restricted by lighting stands or obtrusive mounting devices. Compact size is a significant benefit of the dedolight system. The dedolight uses an industry standard 16 mm (5/8") mounting socket and can be rotated 360°, allowing the head to be suspended upside down.



DST

DST dedolight stand
Collapsed: 48 cm (19")
Maximum extension:
213 cm (7')
Weight: 955 g (2.1 lbs)

DSTFX

DSTFX dedolight flexible stand extension
Compatible with DV6B vacuum mount, CLAMP1 dedolight clamp, or any 16 mm (5/8") stud. It can be bent in any direction, even S-shaped or curled. A wonderful tool in difficult locations.
Length: 51 cm (20"),
Weight: 150 g (5.3 oz.)

DSTX

DSTX Extension dedolight stand extension.
Length: 49,5 cm (1.6'),
Weight: 88 g (3.1 oz.)

DH2

DH2 dedolight wall holder
Made of special elastic aircraft aluminium, the dedolight holder not only tapes to flat surfaces but cut-outs in the plate allow it to be attached to table legs and small or large pipes. Just use the supplied mounting chains or gaffer tape, nails or screws. The base plate's attached two way articulating arm is made of heavy duty spring steel.
Weight: 142 g (5 oz.)

CLAMP1

CLAMP1 dedolight clamp
The dedolight clamp attaches securely to stands, pipes, shelves, etc. up to 4.8 cm (1-7/8") diameter. It is fitted with a 16 mm (5/8") stud that pivots and locks in two positions.
Weight: 147 g (5.2 oz.)



DV6B

DV6B Vacuum mount
152 mm (6") diameter vacuum cup creates a powerful suction, enabling you to mount the dedolight head securely to windows, doors or other flat, nonporous surfaces. Comes complete with a locking swivel joint. The swivel joint has a 16 mm (5/8") stud for easy mounting of light fixtures up to 15 kg (33 lbs).
Weight: 666 g (1.47 lbs)

DWS

DWS Screw mount
16 mm (5/8") stud with wood screw and plate.
Stud length: 20 cm (7.8").
Weight: 140 g (4.9 oz.)

DLUMT

DLUMT Universal mount
Allows the attachment of standard dedolight heads (DLH4) to cameras by 1/4" screw or shoe mount.
Weight: 62 g (2.2 oz.)

DLCLAMP

DLCLAMP Camera clamp
Allows the attachment of a DLOBA² light head to a camera carrying handle. May also be used with DLUMT to attach standard dedolight heads.
Weight: 122 g (4.3 oz.)

DLSA

DLSA Stand adapter
Allows attachment of on-board light head (DLOBA²) to light stands with 16 mm (5/8") stud.
Weight: 57 g (2 oz.)



CLASSIC MOUNTING

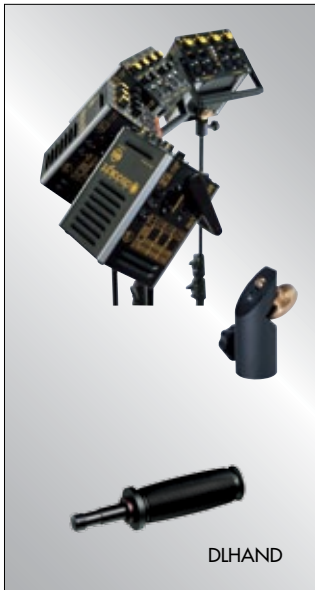

DTSH Power supply stand adapter
Allows mounting of DT12-4, and DT24-3 power supply/control unit to light stands with 16 mm (5/8") studs.
Weight: 343 g (12.1 oz.)

DLHAND Handle
Handle with ribbed rubber grip and 16 mm (5/8") stud for hand-held use of dedolight heads.
Weight: 177 g (6.2 oz.)

THE NOGA/DEDOLIGHT SYSTEM

A high quality mounting-arm-system for light heads, french flags, scrims, nets, monitors, DV-cameras, camera lights.

ARTICULATING MOUNTING ARM

Two arms which rotate 360°. Ball joints on both ends and center screw lock with adjustable friction.



Three different sizes:

NF1105
Mini Steel Mounting Arm
1/4" threads on both ends.
107 mm (4.2") full length.
Weight: 315 g (0.7 lbs)

DG1105 Standard
Aluminum Mounting Arm
1/4" threads on both ends.
211 mm (8.3") full length.
Weight: 300 g (0.67 lbs)

MG1106 Maxi
Aluminum Mounting Arm
1/4" top external, 3/8" bottom external thread. 246.5 mm (9.7") full length.
Weight: 517 g (1.14 lbs)

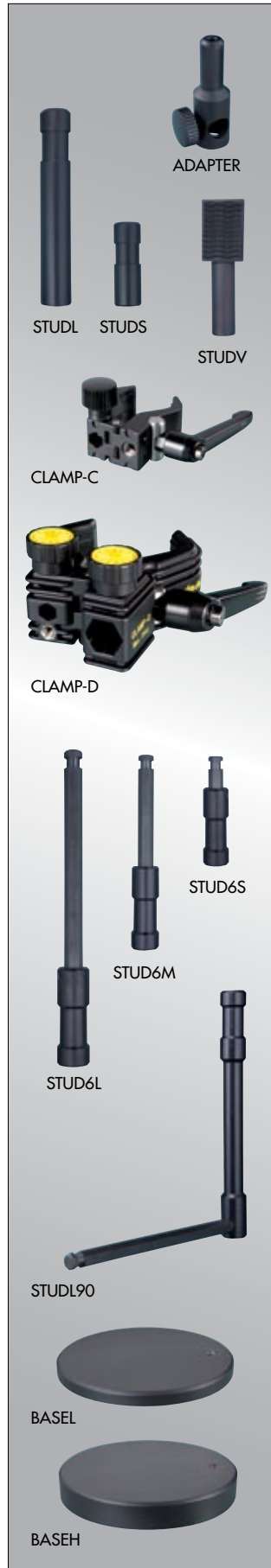

ADAPTER
1/4" internal thread, 16 mm (5/8") receptacle.

STUDL 16 mm (5/8") stud with 1/4" internal thread, 120 mm (4.7").

STUDS 16 mm (5/8") stud with 1/4" internal thread, 48 mm (2").

STUDV Velcro holder with 1/4" internal thread.

CLAMP-C High precision clamp with 1/4" internal thread and hexagonal receptacle. Fits diameters from 13 mm (0.51") to 25,4 mm (1").

CLAMP-D High precision clamp with 1/4" internal thread and hexagonal receptacle. Fits diameters from 25 mm (0,98") to 52 mm (2").

STUD6L Babystud 16 mm (5/8") with hexagonal rod. 150 mm (5,9") length.

STUD6M Babystud 16 mm (5/8") with hexagonal rod. 110 mm (4,33") length.

STUD6S Babystud 16 mm (5/8") with hexagonal rod. 65 mm (2,5") length.

STUDL90 Babystud angle attachment 16 mm (5/8") stud, 150 mm (5,9") length and angle hexagonal rod 151 mm (6,04") length.

BASEL Baseplate with 1/4" internal thread, Ø 120 mm (4.7"), 882 g (2 lbs).

BASEH Baseplate with 1/4" internal thread, Ø 120 mm (4.7"), 1543 g (3.3 lbs).



COOLH dedocool Tungsten Light Head

The first light designed expressly to meet the special requirements of ultra high speed film making and videography.

The dedocool utilizes a low wattage, low voltage lamp working in combination with a unique optical system and a special reflector which concentrates an intense amount of light over a highly concentrated area. Two carefully matched heat reflecting filters and transmitting mirror, route the heat through two forced air ventilators and out the back of the head.

Over short periods of time, heating of the subject is negligible. Even after prolonged shooting sessions, ambient close range temperature could best be described as "warm."

Light to subject distance, maximum 20 cm (8").



COOLT3 Transformer/Control Unit

This Power Supply/Control Unit can simultaneously power two dedocool tungsten light heads. Its AC power input can be set for every AC power in the world from 110V to 240V in six steps.

Each light (output) can be individually and independently switched in four distinct steps, each increasing color temperature and output:

1. Set up position – approx. 3000K – 21V
2. Operating position – approx. 3200K – 24V
3. Boost position – approx. 3300K – 26V

The COOLT3 incorporates an input voltage indicator, enabling the user to determine correct input voltage at a glance and to control color temperature precisely.

Technical Data: COOLH

Weight:	1.84 kg (4 lbs)
Lamp:	24V / 250W (ELC) Osram HLX 64653 or equivalent
Cable length:	690 cm (22' 8")
Mounting:	Standard 16 mm (5/8") receptacle
Input voltage:	21-26V AC (from COOLT3)

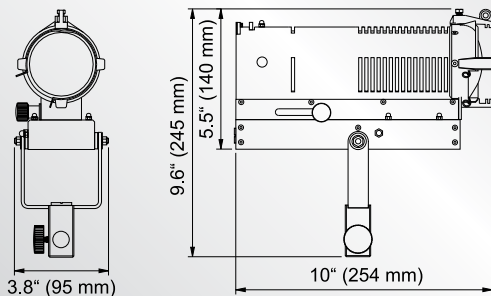

Technical Data: COOLT3

Weight:	4.56 kg (10.2 lbs)
Input voltage:	110V-240V AC (switchable, 6 steps) 100V-240V AC on request
Output voltage:	2 x 21-26V AC (in three steps)
Safety:	Red LED indicator for each output indicating cool down period. Fused input and outputs

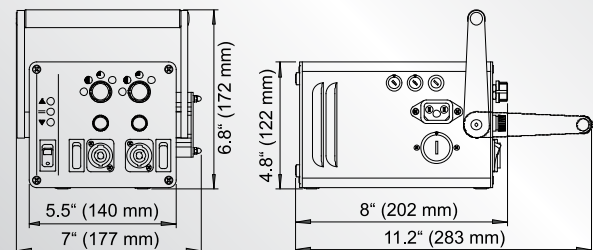

dedolight Heavy Duty Case

We offer heavy duty transport cases and lighter weight carrying cases to safely transport and store dedolight equipment. Both types of cases feature custom interiors to secure your dedolight system, no matter what its configuration is. Transport cases are molded in shock resistant, high density polyethylene to withstand long distance travel and unpredictable handling.

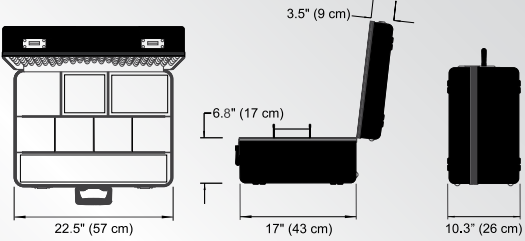
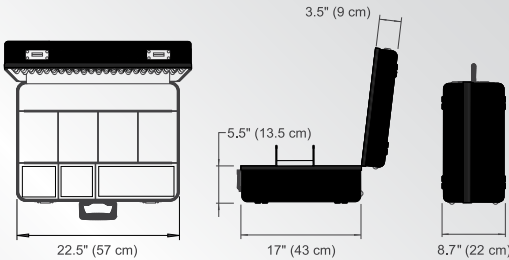
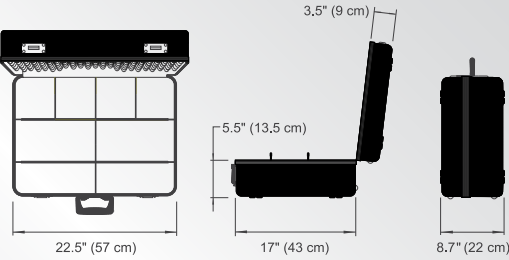
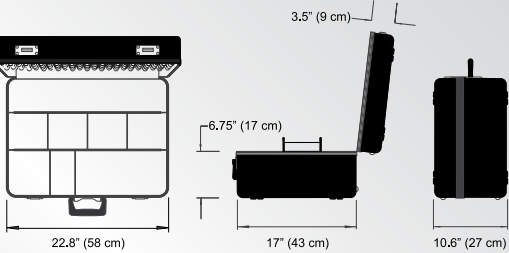
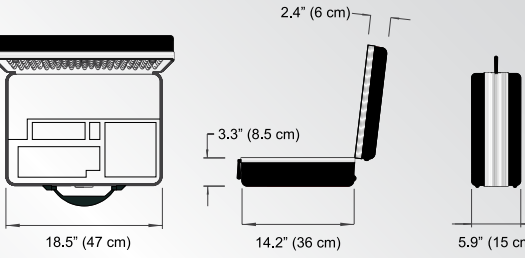
<p>DCHD Heavy duty transport case</p> <p>High impact, polyethylene molded case. Will hold all equipment supplied with K12 and K24 lighting kits.</p> <p>Weight: 6 kg (13.2 lbs) Size: 57 x 43 x 26 cm (22.5 x 17 x 10.3")</p>	
<p>DCHDM4 Heavy duty transport case</p> <p>High impact, polyethylene molded case. Will hold all equipment supplied with KAC and KA1 lighting kits.</p> <p>Weight: 5.3 kg (11.7 lbs) Size: 57 x 43 x 22 cm (22.5 x 17 x 8.7")</p>	
<p>DCHDX Heavy duty transport case</p> <p>High impact, polyethylene molded case. Will hold all equipment supplied with KX accessory kit.</p> <p>Weight: 5.3 kg (11.7 lbs) Size: 57 x 43 x 22 cm (22.5 x 17 x 8.7")</p>	
<p>DCHDKA1 Heavy duty transport case</p> <p>High impact, polyethylene molded case. Will hold all equipment supplied with KA24 lighting kits.</p> <p>Weight: 5.3 kg (11.7 lbs) Size: 58 x 43 x 27 cm (22.8 x 17 x 10.6")</p>	
<p>DCBAT Transport case.</p> <p>Molded carrying case. Will hold all equipment supplied with KBAT and KOB lighting kits.</p> <p>Weight: 2.8 kg (6.2 lbs) Size: 47 x 36 x 15 cm (18.5 x 14.2 x 5.9")</p>	



DCHD200-3

Heavy duty transport case

High impact, polyethylene molded case.
Will hold all equipment supplied in K200-3 Sundance kit.

Weight: 6.6 kg (14.6 lbs)
Size: 58 x 43 x 29 cm (22.8 x 17 x 11.4")

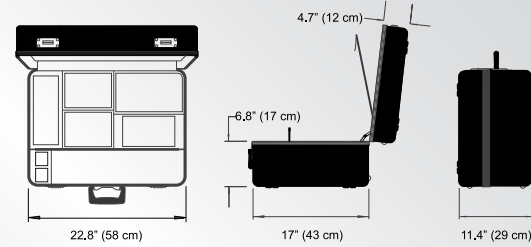

DCHD200-1

Heavy duty transport case

High impact, polyethylene molded case.
Will hold all equipment supplied in K200-1 Sundance kit.

Weight: 2.8 kg (6.2 lbs)
Size: 46 x 33 x 22 cm (18 x 13 x 8.7")

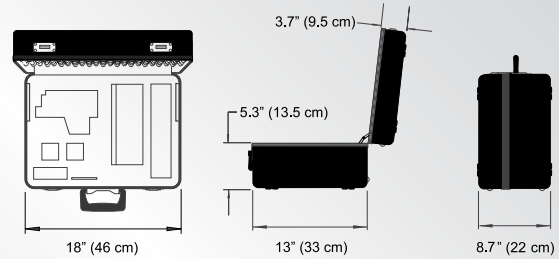

DCHD400

Heavy duty transport case

High impact, polyethylene molded case for DLH400DT or DLH650 or DLH436 light head and ballast/control unit.

Weight: 5.0 kg (9.7 lbs)
Size: 57 x 43 x 26 cm (22.5 x 17 x 10.3")

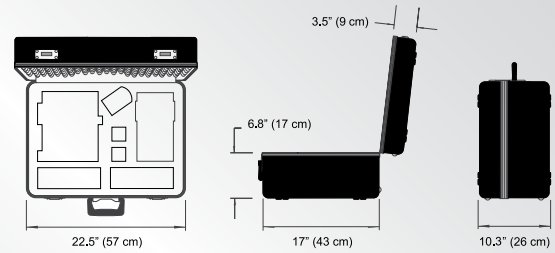

DCHD3x4

Heavy duty transport case

High impact, polyethylene molded case for three DLH400DT or three DLH436 light heads and ballasts/control units (with wheels).

Weight: 12.5 kg (27.6 lbs)
Size: 105 x 53 x 34 cm (41.3 x 21 x 13.4")

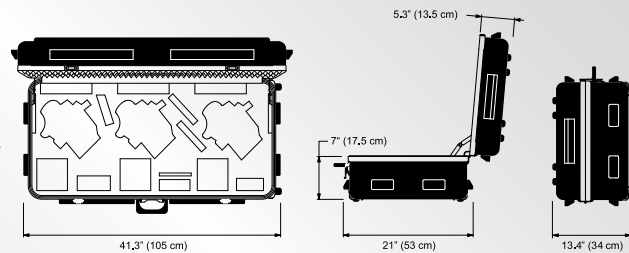

DCHD3x6

Heavy duty transport case

High impact, polyethylene molded case for three DLH650 light heads and accessories (with wheels).

Weight: 12.5 kg (27.6 lbs)
Size: 105 x 53 x 31 cm (41.3 x 21 x 12.3")

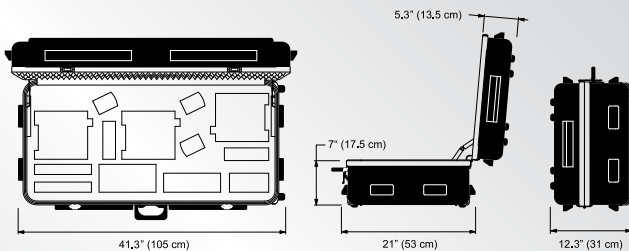

DCDP400

Heavy duty transport case

High impact, polyethylene molded case for DP400 imager in standard configurations and additional space for accessories.

Weight: 4.2 kg (9.3 lbs)

Size: 46.5 x 35 x 25 cm (18.3 x 13.8 x 10")

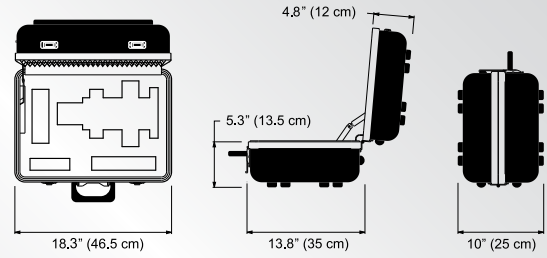

DCPAR

Heavy duty transport case

High impact, polyethylene molded case for dedoPAR light head with direct/soft attachment and accessories.

Weight: 6.0 kg (13.2 lbs)

Size: 58 x 43 x 29 cm (22.8 x 17 x 11.4")

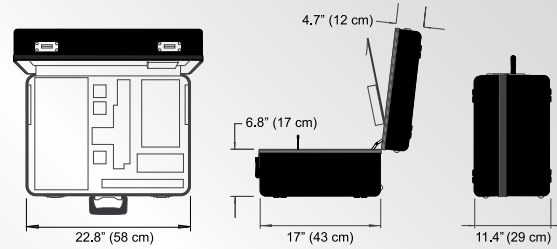

Portable Studio

dedolight soft cases are extremely robust and offer excellent protection of the equipment even when used as checked baggage during airline transport (one of the ultimate tests of ruggedness). Especially useful for mobile teams. Small dividers inside the cases are adjustable for individual requirements.

DSC1/1-200

Softcase, small

Weight: 3 kg (6.6 lbs)

Size: 65 x 23 x 30 cm (25.6 x 9.1 x 11.8")

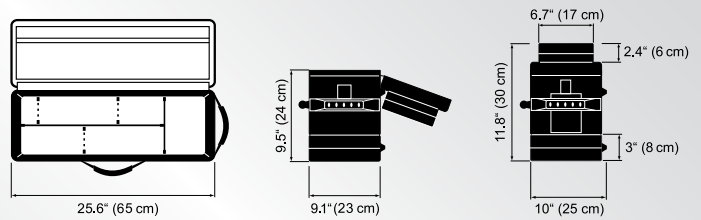

DSC2/2-200

Softcase, medium

Weight: 3.8 kg (8.4 lbs)

Size: 83 x 30 x 33 cm (32.7 x 11.8 x 13")

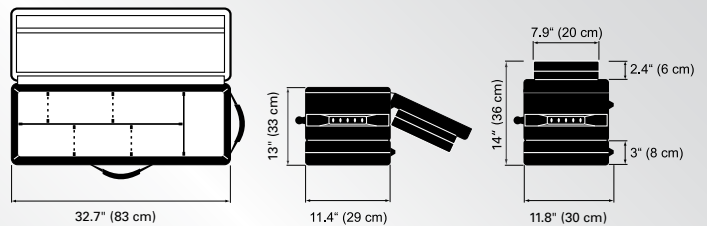

DSCXLW

Softcase, large

case with dividers and wheels. Will hold "Interviewer" kit and extra equipment.

Weight: 5.8 kg (12.8 lbs)

Size: 94 x 30 x 38 cm (37 x 11.8 x 14.9")

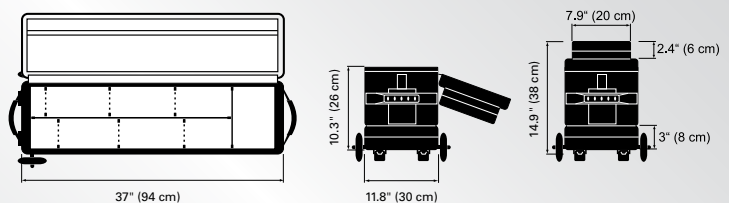

DSCM

Soft case, mono

Holds a single classic series light head, power supply and imager.

Weight: 786 g (1.7 lbs)

Size: 28 x 17 x 25 cm (11 x 6.7 x 10")

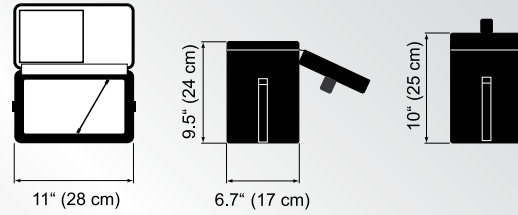

DSCPA5 (DSCOCT)

Soft case

Holds complete PanAura®/Octodome 5 kits.

Weight: 2.6 kg (5.7 lbs)

Size: 94 x 21 x 37 cm (37 x 8.3 x 14.6")

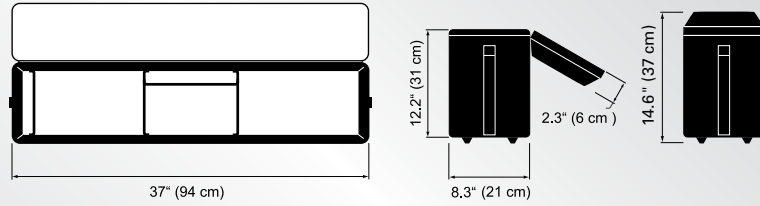

DSCST

Soft bag

Bag for three stands (DST400).

Weight: 1.9 kg (4.2 lbs)

Size: 112 x 17 x 17 cm (44.1 x 6.7 x 6.7")

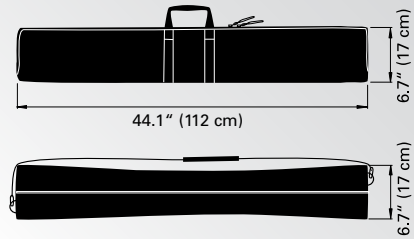

DSC400

Soft case

Will hold DLH400DT and DEB400DT electronic ballast.

Weight: 4.2 kg (9.3 lbs)

Size: 42 x 33 x 39 cm (16.5 x 13 x 15.4")

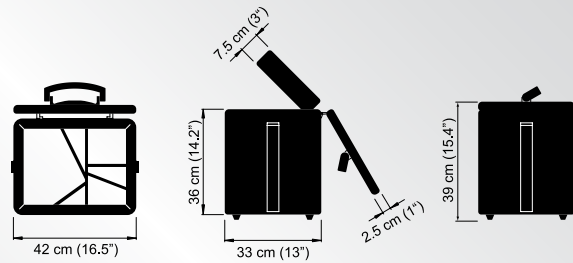

DSC150S

Soft bag

Will hold complete Baby Soft kits.

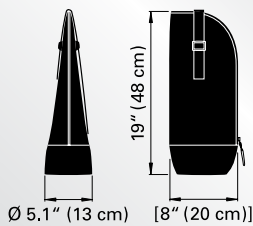

Weight: 500 g (1.1 lbs)

Size: 48 x 13 x 20 cm (19 x 5.1 x 8")

DSC300S

Soft bag

Will hold complete Junior Soft kits.

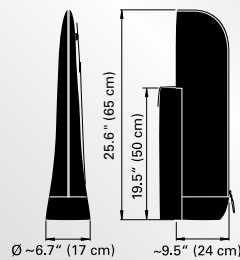

Weight: 400 g (2.0 lbs)

Size: 65 x 17 x 24 cm (25.6 x 6.7 x 9.4")

DSC1000S

Soft bag

Will hold complete Senior Soft kits.

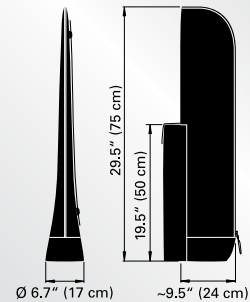

Weight: 500 g (2.0 lbs)

Size: 75 x 17 x 24 cm (29.5 x 6.7 x 9.4")



Soft Case Kits - Portable Studio

- Mainly intended for mobile crews
- Compact, sturdy, lightweight, versatile

The soft case kits offer half the weight and less than half the size of most traditional travel kits from other manufacturers.

Light output is comparable to much larger traditional instruments but offer a higher degree of control, efficiency and versatility with significantly lower power consumption.

Each kit contains a soft light source for soft key lighting and several high precision focusing dimmable dedolights.

Interior and exterior applications require the need for versatility of powering from mains as well as from a battery. The DLH4 light head and the DLH1x150S soft light can be powered from mains with the appropriate DT24-1 dimmable power supply. The attachment of an adapter cable will allow them to operate with a battery belt, on-board battery or a car cigarette lighter.

The DLHM4-300 lights are even more compact, quicker to set up and contain a built in dimmable power supply. This fixture is designed for mains power only.

The DT24-1 in-line dimmable power supplies are available in three mains powered versions:

DT24-1E	(Europe)	230 / 240V AC
DT24-1U	(USA)	117V AC
DT24-1J	(Japan)	100V AC

The DLHM4-300 dimmable light heads are available in four mains powered versions:

DLHM4-300E	(Europe)	230V AC
DLHM4-300E+	(Australia)	240V AC
DLHM4-300U	(USA)	117V AC
DLHM4-300J	(Japan)	100V AC

Mains powered soft lights may be used with lamps of the required voltage. Depending on your desire to accomplish more refined and elaborate lighting setups, each kit is offered in three versions. Basic, standard and master kits.



Most standard and master kits include one Imager projection attachment, which can be used for highly defined light shapes or for gobo projections on otherwise dull backgrounds.

dedolight soft cases are extremely robust and offer excellent protection of the equipment even if used as checked baggage during airline transport (one of the ultimate tests of ruggedness).

Hard Case Kits

- Designed for all lighting applications
- Compact, sturdy, lightweight, versatile

These portable kits are compact, sturdy, lightweight and versatile. Smaller in size and weight than most traditional lighting kits.

Light output is comparable to much larger traditional instruments but offer a higher degree of control, efficiency and versatility with significantly lower power consumption.

Interior and exterior applications require the need for versatility of powering from mains as well as from a battery. The K12 and K24 kits supply power to three (150W) or four (100W) DLH4 light heads from a single master power supply. Input voltage is switchable from 100-255V AC in five volt steps for world wide use. A voltage indicator allows the precise setting of the power supply to match actual voltage levels in different locations and compensate for voltage drops in long supply lines. This guarantees exact color temperature in calibrated steps.

Our hard transport cases are heavy duty, yet lightweight to safely transport and store all dedolight equipment. They feature custom interiors and are moulded of shock resistant, high density polyethylene to withstand long distance travel and unpredictable handling.



SERIES 400 KITS

Kit Configuration

code	p.	description	kit code																			
			K400DT-B	K400DT-S	S400DT	K436	K3x650-B	K3x650-S	K3x400DT-B	K3x400DT-S	SPA5DT-B	SPA5DT-S	SPA5T-B	SPA5T-S	SPA5DTT	KDP400KU	KDP400KFS	KPAR(-1)	COOLSET			
DLH400DT	18	Light head 400/575 W daylight/tungsten	1	1	1							3	3									
DLH650	24	Light head 650W tungsten							3	3												
DLH436	25	Light head 400W / 36V tungsten				1																
DLH400SDT	19	Soft light 400 / 575 W daylight / tungsten												1	1			1				
HTP400S		High temperature pouch												1	1			1				
DLH1000SPLUS	20	Soft light 1000W tungsten													1	1	1					
HTP1000S		High temperature pouch													1	1	1					
DLPA5 (DSBOCT)	19	PanAura® / Octodome 5												1	1	1	1	1				
DLPA5G (DLGRIDOCT)	19	Grid for PanAura® / Octodome 5													1	1						
DEB400DT	18	Electronic ballast 400 / 575 W	1	1	1							3	3	1	1			1				
DT36-1	25	Power supply 400W / 36V					1															
DPOW400DT	-	Light head cable (400) 7 m (23 ')	1	1	1							3	3	1	1			1				
DPOW436	-	Light head cable (436) 8 m (26.2 ')					1															
DEB400H	26	Ballast holder (with clamp)		1	1								3	1	1			1				
DBD400	26	Barn door (eight leaves)	1	1	1	1	3	3	3	3												
DPLS400	26	Light shield ring	1	1	1	1	3	3	3	3												
DSCK400	26	Scrim kit	1	1	1	1	3	3	3	3												
DSCP400	26	Scrim pouch	1	1	1	1	3	3	3	3												
DFH400	26	Filter holder	1	1	1	1	3	3	3	3												
DGRADF400-06	26	Graduated glass filter (ND 0.6)		1				2		2												
DP400CON	28	Imager 400 condenser																1	1			
DP400U	28	Imager 400 universal receptacle																1	1			
DP400FS	28	Imager 400 framing shutter assembly																	1			
DP400LH	29	Imager 400 projection lens holder																1	1			
DP400-185	29	Imager 400 projection lens, 185 mm																1	1			
DP400GH	29	Imager 400 gobo holder																1				
DP400FS	29	Imager 400 framing shutter set																1				
DST400	26	Stand								3		3										
DST400S	26	Stand, compact												1	1	1	1	1				
DL400DHR-NB	18	Daylight lamp 400 / 575 W	1	1	1							3	3	1	2			1				
36DL400LL	-	Tungsten lamp 36V / 400 W					2															
DL650FRM-NB	-	Tungsten lamp 650W																				
DL1000FEP-NB	21	Tungsten lamp 1000W																				
			See kit contents for lamps included.																			
DCHD400	57	Hard case (DLH400DT, DLH436, DLH650)	1	1		1																
DSC400	59	Soft case (DLH400DT, DLH436, DLH650)			1																	
DCHD3x4	57	Hard case (3 x DLH400DT)										1	1									
DCHD3x6	57	Hard case (3 x DLH650)						1	1													
DSCPA5 (DSCOCT)	59	Soft case (PanAura® / Octodome 5 kit)												1	1	1	1	1				
DCDP400	58	Hard case (Imager DP400)																1	1			
DSCST	59	Stand bag						1			1											

See kit lists on page 67 for kit configuration.

HARD CASE/SOFT CASE DAYLIGHT SERIES 400

K400DT-B Basic 400 / 575W Daylight/ Tungsten Kit

- 1 DLH400DT Light head 400 / 575W daylight / tungsten
- 1 DEB400DT Electronic ballast 400 / 575W daylight / tungsten
- 1 DPOW400DT Light head cable 7 m (23')
- 1 DFH400 Filter holder
- 1 DBD400 Barn door
- 1 DPLS400 Light shield ring
- 1 DSCK400 Scrim kit
- 1 DSCP400 Scrim pouch
- 1 DL400DHR-NB Daylight lamp 400 / 575W
- 1 DCHD400 Hard case

Weight: 14.9 kg (32.9 lbs)

Size: 57 x 43 x 26 cm (22.5 x 17 x 10.25")



K400DT-S Standard 400 / 575W Daylight/ Tungsten Kit

(items in bold are in addition to basic kit)

- 1 DLH400DT Light head 400 / 575W daylight / tungsten
- 1 DEB400DT Electronic ballast 400 / 575W daylight / tungsten
- 1 **DEB400H Ballast holder with clamp**
- 1 DPOW400DT Light head cable 7 m (23')
- 1 DFH400 Filter holder
- 1 DBD400 Barn door
- 1 DPLS400 Light shield ring
- 1 **DGRADF400-06 Graduated glass filter (ND 0.6)**
- 1 DSCK400 Scrim kit
- 1 DSCP400 Scrim pouch
- 1 DL400DHR-NB Daylight lamp 400 / 575W
- 1 DCHD400 Hard case

Weight: 15.3 kg (33.6 lbs)

Size: 57 x 43 x 26 cm (22.5 x 17 x 10.25")



S400DT Standard 400 / 575W Daylight/Tungsten Kit

- 1 DLH400DT Light head 400 / 575W daylight / tungsten
- 1 DEB400DT Electronic ballast 400 / 575W daylight / tungsten
- 1 **DEB400H Ballast holder with clamp**
- 1 DPOW400DT Light head cable 7 m (23')
- 1 DFH400 Filter holder
- 1 DBD400 Barn door
- 1 DPLS400 Light shield ring
- 1 DSCK400 Scrim kit
- 1 DSCP400 Scrim pouch
- 1 DL400DHR-NB Daylight lamp 400 / 575W
- 1 DSC400 Soft case

Weight: 13.2 kg (29.1 lbs)

Size: 42 x 33 x 40.5 cm (16.5 x 13 x 15.4")



K436 Standard 400W / 36V Tungsten Kit

- 1 DLH436 Light head 400W / 36V
 - 1 DT36-1 Ballast
 - 1 DPOW436 Light head cable 8 m (26.2')
 - 1 DFH400 Filter holder
 - 1 DBD400 Barn door
 - 1 DPLS400 Light shield ring
 - 1 DSCK400 Scrim kit
 - 1 DSCP400 Scrim pouch
 - 2 36DL400LL Lamp 400W / 36V
 - 1 DCHD400 Hard case
- Weight: 16.7 kg (36.8 lbs)
 Size: 57 x 43 x 26 cm (22.5 x 17 x 10.25")



K3x650-B Basic 650W Tungsten Kit

- 3 DLH650 Light head 650W with 5 m (16.4') cable
 - 3 DFH400 Filter holder
 - 3 DBD400 Barn door
 - 3 DPLS400 Light shield ring
 - 3 DSCK400 Scrim kit
 - 3 DSCP400 Scrim pouch
 - 5 DL650FRM-NB Lamp 230V / 650W *
 - 1 DCHD3x6 Hard case
- Weight: 24.3 kg (53.6 lbs)
 Size: 105 x 53 x 31 cm (41.25 x 21 x 12.25")
 *option: DL650FRK-NB Lamp 120V / 650W



K3x650-S Standard 650W Tungsten Kit

(items in bold are in addition to basic kit)

- 3 DLH650 Light head 650W with 5 m (16.4') cable
 - 3 DFH400 Filter holder
 - 3 DBD400 Barn door
 - 3 DPLS400 Light shield ring
 - 2 DGRADF400-06 Graduated glass filter (ND 0.6)**
 - 3 DSCK400 Scrim kit
 - 3 DSCP400 Scrim pouch
 - 3 DST400 Stand**
 - 1 DSCST Stand bag**
 - 5 DL650FRM-NB Lamp 230V / 650W *
 - 1 DCHD3x6 Hard case
- Weight: 31.4 kg (69.2 lbs)
 Size: 105 x 53 x 31 cm (41.25 x 21 x 12.25")
 *option: DL650FRK-NB Lamp 120V / 650W



HARD CASE DAYLIGHT SERIES 400

K3x400DT-B Basic 400 / 575W Daylight / Tungsten Kit

- 3 DLH400DT Light head 400 / 575W daylight / tungsten
- 3 DEB400DT Electronic ballast 400 / 575W daylight / tungsten
- 3 DPOW400DT Light head cable 7 m (23')
- 3 DFH400 Filter holder
- 3 DBD400 Barn door
- 3 DPLS400 Light shield ring
- 3 DSCK400 Scrim kit
- 3 DSCP400 Scrim pouch
- 3 DL400DHR-NB Daylight lamp 400 / 575W
- 1 DCHD3x4 Hard case

Weight: 39.8 kg (87.4 lbs)

Size: 105 x 53 x 34 cm (41.3 x 21 x 13.4")



K3x400DT-S Standard 400 / 575W Daylight / Tungsten Kit (items in bold are in addition to basic kit)

- 3 DLH400DT Light head 400 / 575W daylight / tungsten
- 3 DEB400DT Electronic ballast 400 / 575W daylight / tungsten
- 3 DPOW400DT Light head cable 7 m (23')
- 3 DEB400H Ballast holder with clamp**
- 3 DFH400 Filter holder
- 3 DBD400 Barn door
- 3 DPLS400 Light shield ring
- 2 DGRADF400-06 Graduated glass filter (ND 0.6)**
- 3 DSCK400 Scrim kit
- 3 DSCP400 Scrim pouch
- 3 DST400 Stand**
- 1 DSCST Stand bag**
- 3 DL400DHR-NB Daylight lamp 400 / 575W
- 1 DCHD3x4 Hard case

Weight: 47.8 kg (105.4 lbs)

Size: 105 x 53 x 34 cm (41.3 x 21 x 13.4")



SPA5DT-S (DSOCTDT400) Standard PanAura[®] / Octodome 5 Daylight / Tungsten Kit

1 DLH400SDT	Soft light head 400 / 575 W daylight / tungsten
1 HTP400S	High temperature pouch
1 DEB400DT	Electronic ballast 400 / 575 W daylight / tungsten
1 DPOW400DT	Light head cable 7 m (23')
1 DEB400H	Ballast holder with clamp
1 DLPA5 (DSBOCT)	PanAura [®] / Octodome 5
1 DLPA5G (DLGRIDOCT)	Grid for PanAura [®] / Octodome
2 DL400DHR-NB	Daylight lamp 400 / 575 W
1 DST400S	Stand
1 DSCPA5 (DSCOCT)	Soft case

Weight: 13.0 kg (28.6 lbs)
Size: 94 x 21 x 37 cm (37 x 8.3 x 14,6")

SPA5T-S (DSOCTT-S) Standard PanAura[®] / Octodome 5 Tungsten Kit

1 DLH1000SPUS	Soft light head 1000W halogen with 3 m (9.8') cable
1 HTP1000S	High temperature pouch
1 DLPA5 (DSBOCT)	PanAura [®] / Octodome 5
1 DLPA5G (DLGRIDOCT)	Grid for PanAura [®] / Octodome 5
2 DL1000FEP-NB	Lamp 230 / 240 V / 1000 W *
1 DST400S	Stand
1 DSCPA5 (DSCOCT)	Soft case

Weight: 8.5 kg (18.6 lbs)
Size: 94 x 21 x 37 cm (37 x 8.3 x 14,6")
***option: DL1000FEL-NB Lamp 120V / 1000W**

SPA5DT-B (DSOCTD) Basic PanAura[®] / Octodome 5 Kit

same as above but without DLPA5G (DLGRIDOCT)
and one lamp less.
Weight: 12.5 kg (27.3 lbs)

SPA5T-B (DSOCTT) Basic PanAura[®] / Octodome 5 Kit

same as above but without DLPA5G (DLGRIDOCT)
and one lamp less.
Weight: 8.5 kg (18.6 lbs)



SPA5DTT (DSOCTDT) PanAura[®] / Octodome 5 Daylight / Tungsten and Tungsten Kit

1 DLH400SDT	Soft light head 400 / 575 W daylight / tungsten
1 HTP400S	High temperature pouch
1 DEB400DT	Electronic ballast 400 / 575 W daylight / tungsten
1 DPOW400DT	Light head cable 7 m (23')
1 DEB400H	Ballast holder with clamp
1 DL400DHR-NB	Daylight lamp 400 / 575 W
1 DLH1000SPUS	Soft light head 1000W halogen with 3 m (9.8') cable
1 HTP1000S	High temperature pouch
1 DL1000FEP-NB	Lamp 230 / 240 V / 1000 W *
1 DLPA5 (DSBOCT)	PanAura [®] / Octodome 5
1 DST400S	Stand
1 DSCPA5 (DSCOCT)	Soft case

Weight: 13.8 kg (30 lbs)
Size: 94 x 21 x 37 cm (37 x 8.3 x 14,6")
***option: DL1000FEL-NB Lamp 120V / 1000W**

HARD CASE IMAGER 400

KDP400KU Imager Kit

- 1 DP400CON Condenser
 - 1 DP400U Universal receptacle for gobo holder, shutter blades or iris
 - 1 DP400LH Lens holder barrel
 - 1 DP400-185 Lens 185 mm
 - 1 DP400GH Gobo holder
 - 1 DCDP400 Hard case
- Weight: 5.9 kg (13 lbs)
Size: 46.5 x 35 x 25 cm (18.25 x 13.75 x 10")



KDP400KFS Imager Kit

- 1 DP400CON Condenser
 - 1 DP400FS Framing shutter module with built-in shutter blades
 - 1 DP400LH Lens holder barrel
 - 1 DP400-185 Lens 185 mm
 - 1 DCDP400 Hard case
- Weight: 6.3 kg (13.9 lbs)
Size: 46.5 x 35 x 25 cm (18.25 x 13.75 x 10")



KPAR dedoPAR 400 / 575W Daylight Kit

- 1 DPAR dedoPAR light head with reflector
- 1 DPAR-S Direct / soft attachment
- 1 DLSR-8 Speed ring for soft boxes with 4 or 8 rods
- 1 DSBSM dedoflex silver dome, medium
- 1 DPARBD Barn door
- 1 DPARD1 Spread lens, flood
- 1 DPARD2 Spread lens, spot
- 1 DPARD3 Spread lens, medium
- 1 DEB400DT Electronic ballast 400 / 575 W daylight / tungsten
- 1 DPOW400DT Light head cable 7 m (23')
- 1 DL400DHR-NB Daylight lamp 400 / 575 W
- 1 DCPAR Hard case

Weight: 14.9 kg (32.9 lbs)

Size: 58 x 42 x 29 cm (22.8 x 17 x 11.4")



KPAR-1 dedoPAR 400 / 575W Daylight Kit

- 1 DPAR dedoPAR light head with reflector
- 1 DPARBD Barn door
- 1 DPARD1 Spread lens, flood
- 1 DPARD2 Spread lens, spot
- 1 DPARD3 Spread lens, medium
- 1 DEB400DT Electronic ballast 400 / 575 W daylight / tungsten
- 1 DPOW400DT Light head cable 7 m (23')
- 1 DL400DHR-NB Daylight lamp 400 / 575 W
- 1 DCPAR Hard case

Weight: 14 kg (30.9 lbs)

Size: 58 x 42 x 29 cm (22.8 x 17 x 11.4")

COOLSET dedocool Cool Light Kit

- 2 COOLH dedocool light head
- 1 COOLT3 Transformer with mains cable
- 2 DBD8 Barn door
- 2 DST Stand
- 4 COOLAMP Lamp 24V / 250 W
- 1 DCHDCOOL Hard case

Weight: 17.4 kg (38.4 lbs)

Size: 57 x 43 x 26 cm (22.5 x 17 x 10.3")



Sundance Kits

Unique versatility for the demanding team on the move.
Converts from daylight to tungsten operation:

- The DLH200DT daylight focusing light head can be changed to tungsten balance by either installing a DTCF tungsten conversion filter or by changing to the DL200THR-NB ceramic lamp.
- The DLH200SDT daylight soft light can be quickly and easily changed to tungsten balance by installing the DL200THR-NB ceramic lamp.

The unique DL200THR-NB ceramic 3200K lamp, operates with the same DEB200DT flicker free ballast as used with the daylight balanced lamp.

Kit Configuration

code	p.	description	kit code				
			K200-1	K200-3	S200-2	S200-2M	S200-3
DLH200DT	31	Light head 200 W Sundance	1	2	1	1	2
DLH200SDT	31	Soft light head 200 W Sundance		1	1	1	1
HTP200S	-	High temperature pouch		1	1	1	1
DSBSS	21	Silver Dome, small		1	1		
DSBSM	21	Silver Dome, medium				1	1
DEB200DT	32	Electronic ballast 200 W	1	3	2	2	3
DEB200H	-	Ballast holder with CLAMP-C		3	2	2	3
DPOW200DT	33	Light head cable 7 m (23')	1	3	2	2	3
DBD8	45	Barn door (eight leaves)	1	2	1	1	2
DPLS	45	Light shield ring	1	2	1	1	2
DTCF	47	Tungsten conversion filter		2	1	1	2
DL200DHR-NB	31	Daylight lamp 200 W	1	3	3	3	3
DL200THR-NB	31	Tungsten ceramic lamp 200 W		1	1	1	1
DST	53	Stand		3	2	2	3
DCHD200-1	57	Hard case	1				
DCHD200-3	57	Hard case		1			
DSC1/1-200	59	Soft case, small			1		
DSC2/2-200	59	Soft case, medium				1	1

K200-1 Sundance Kit Daylight / Tungsten

- 1 DLH200DT Light head 200W Sundance
 - 1 DEB200DT Electronic ballast 200W daylight/tungsten
 - 1 DPOW200DT Light head cable 7 m (23')
 - 1 DBD8 Barn door
 - 1 DPLS Light shield ring
 - 1 DL200DHR-NB Daylight lamp 200W
 - 1 DCHD200-1 Hard case
- Weight: 6.1 kg (13.5 lbs)
 Size: 46 x 33 x 22 cm (18 x 13 x 8.7")



K200-3 S Sundance Kit Daylight/Tungsten

- 2 DLH200DT Light head 200W Sundance
 - 1 DLH200SDT Soft light head 200W Sundance
 - 1 HTP200S High temperature pouch
 - 3 DEB200DT Electronic ballast 200W daylight / tungsten
 - 3 DEB200H Ballast holder with CLAMP-C
 - 3 DPOW200DT Light head cable 7 m (23')
 - 1 DSBSS Silver dome small
 - 2 DBD8 Barn door
 - 2 DPLS Light shield ring
 - 2 DTCF Tungsten conversion filter
 - 3 DL200DHR-NB Daylight lamp 200W
 - 1 DL200THR-NB Ceramic tungsten lamp 200W
 - 3 DST Stand
 - 1 DCHD200-3 Hard case
- Weight: 18.3 kg (40.3 lbs)
 Size: 58 x 43 x 29 cm (22.8 x 17 x 11.4")



S200-2 Sundance Kit Daylight/ Tungsten

- 1 DLH200DT Light head 200W Sundance
 - 1 DLH200SDT Soft light head 200W Sundance
 - 1 HTP200S High temperature pouch
 - 2 DEB200DT Electronic ballast 200W daylight / tungsten
 - 2 DEB200H Ballast holder with CLAMP-C
 - 2 DPOW200DT Light head cable 7 m (23')
 - 1 DSBSS Silver dome small
 - 1 DBD8 Barn door
 - 1 DPLS Light shield ring
 - 1 DTCF Tungsten conversion filter
 - 2 DL200DHR-NB Daylight lamp 200W
 - 1 DL200THR-NB Ceramic tungsten lamp 200W
 - 2 DST Stand
 - 1 DSC1/1-200 Soft case, small
- Weight: 12.5 kg (27.4 lbs)
Size: 65 x 23 x 30 cm (25.6 x 9.1 x 11.8")



S200-2M Sundance Kit Daylight/ Tungsten

- 1 DLH200DT Light head 200W Sundance
 - 1 DLH200SDT Soft light head 200W Sundance
 - 1 HTP200S High temperature pouch
 - 2 DEB200DT Electronic ballast 200W daylight / tungsten
 - 2 DEB200H Ballast holder with CLAMP-C
 - 2 DPOW200DT Light head cable 7 m (23')
 - 1 DSBSM Silver dome, medium
 - 1 DBD8 Barn door
 - 1 DPLS Light shield ring
 - 1 DTCF Tungsten conversion filter
 - 2 DL200DHR-NB Daylight lamp 200W
 - 1 DL200THR-NB Ceramic tungsten lamp 200W
 - 2 DST Stand
 - 1 DSC2/2-200 Soft case, medium
- Weight: 13.3 kg (29.3 lbs)
Size: 83 x 30 x 33 cm (32.7 x 11.8 x 13")

S200-3 Sundance Kit Daylight/ Tungsten

- 2 DLH200DT Light head 200W Sundance
 - 1 DLH200SDT Soft light head 200W Sundance
 - 1 HTP200S High temperature pouch
 - 3 DEB200DT Electronic ballast 200W daylight / tungsten
 - 2 DEB200H Ballast holder with CLAMP-C
 - 3 DPOW200DT Light head cable 7 m (23')
 - 1 DSBSM Silver dome, medium
 - 2 DBD8 Barn door
 - 2 DPLS Light shield ring
 - 2 DTCF Tungsten conversion filter
 - 3 DL200DHR-NB Daylight lamp 200W
 - 1 DL200THR-NB Ceramic tungsten lamp 200W
 - 3 DST Stand
 - 1 DSC2/2-200 Soft case, medium
- Weight: 20.2 kg (44.5 lb)
Size: 83 x 30 x 33 cm (32.7 x 11.8 x 13")



HARD CASE TUNGSTEN CLASSIC

Kit Configuration

code	p.	description	kit code																	
			K12B	K12S	K12M	K24B	K24S	K24M	KAC24B	KAC24S	KAC24M	KA1B	KA1S	KA1M	KA24B	KA24S	KA24M	KA24-4B	KA24-4M	SUPERMAX
DLH4	34	aspherics ² light head tungsten	4	4	4	3	3	3				4	4	4	3	3	3	4	4	4
DLHM4-300	34	aspherics ² light head tungsten 150 (int.)							4	4	4									
DIMTA3	40	12V/100W in-line power s. (230V AV)										4	4	4						
DT24-1	40	24V/150W in-line power supply													3	3	3	4	4	
DT12-4	38	4x 12V/100W power supply	1	1	1															1
DT24-3	39	3x 24V/150W power supply				1	1	1												
DPOW3	39	Light head cable 8 m (26.2') (DLH4)	4	6	6	3	6	6												6
DXBAT4-3	39	Battery cable	1	1	1															1
DCAR3	39	Cigarette lighter adapter		1	1															1
DBD8	45	Barn door (eight leaves)	4	4	4	3	3	3	4	4	4	4	4	4	3	3	3	4	4	4
DPLS	45	Light shield ring		2	4		2	3		2	4					2	3	4	4	4
DDCF	47	Daylight conversion filter			4		3	3		4	4					3	3			4
DSCK	45	Scrim kit						1			1									4
DSCP	45	Scrim pouch						1			1									4
DGRADF06	45	Graduated glass filter (ND 0.6)						1			1						1			2
DGRADF09	45	Graduated glass filter (ND 0.9)																		2
DFH	45	Filter holder		4	4		3	3		4	4		4	4		3	4	4	4	8
DGMB	46	Gel filter set, mixed blue		1	1								1	1						1
DGMD	46	Gel filter set, mixed diffusion		1	1		1	1		1	1		1	1		1	1			2
DGW	46	Gel filter set, warm tone			1			1			1			1			1			2
DGB8	46	Gel filter set, full blue																		1
DGMB8	46	Gel filter set, mixed blue																		1
DGND8	46	Gel filter set, neutral density																		1
DGCOL8	46	Gel filter set, color effect																		1
DP1	49	Imager projection attachment (w/lens)						1		1	1		1	1		1	1		1	1
DP2	51	Imager, framing shutter (w/lens)																		1
DP3	51	Imager, slide (w/lens)																		1
DPL60M	48	Projection lens, 60 mm																		1
DPLZ120M	48	Zoom lens, 70-120 mm																		1
DPLZ150M	48	Zoom lens, 85-150 mm																		1
DPX	48	Extension tube																		1
DPEYESET	52	Eye attachment																		1
DPEYEP	52	Pouch for DPEYESET																		1
DPGH	49	Gobo holder						1		1	1		1	1		1	1		1	1
DPFS	49	Framing shutter set						1		1	1		1	1		1	1		1	1
DPIR	49	Iris						1		1	1		1	1		1	1		1	1
DST	53	Stand	4	4	4	3	3	3	4	4	4	4	4	4	3	3	3	4	4	4
DSTFX	53	Stand extension		1	2		1	2		1	2		1	2		1	2	1	1	2
DH2	53	dedolight wall holder	1	2	2		2	2	1	2	2	1	2	2	1	2	2	1	1	2
CLAMP1	53	dedolight clamp	1	2	2		1	2	1	2	2	1	1	2	1	2	2	1	2	2
DV6B	53	Vacuum mount		1	1		1	1			1			1			1			1
DL150	44	Tungsten lamp 24V/150W				6	6	10	6	8	10				6	8	10	8	8	
DL100	44	Tungsten lamp 12V/100W	6	8	10							6	8	10						10
DL50	44	Tungsten lamp 12V/50W		2	4															4
DL20	44	Tungsten lamp 12V/20W		2	4															4
DLBOX	-	Plastic box	1	2	3	1	2	3	1	3	3	1	2	3	1	2	2	2	2	6
DCHD	56	Hard case	1	1	1	1	1	1												1
DCHDM4	56	Hard case							1	1	1	1	1	1						
DCHDKA1	56	Hard case													1	1	1	1	1	
DCHDX	56	Hard case																		1

HARD CASE TUNGSTEN CLASSIC

K12 100 W / 12 V Tungsten Kits

One DT12-4 master control unit operates four DLH4 light heads with 12V / 100W lamps. Input voltage on the control unit can be adjusted from 100 to 255V AC. Color temperature and intensity is switchable in three calibrated steps for each light head.

K12B Basic 100 W / 12 V Tungsten Kit

4 DLH4	Light head aspherics ²	1 CLAMP1	Clamp
1 DT12-4	Power supply 4 x 12V	6 DL100	Halogen lamp 12V / 100W
4 DPOW3	Light head cable 8 m (26.2')	1 DLBOX	Plastic box
1 DXBAT4-3	Battery cable	1 DCHD	Transport hard case
4 DBD8	Barn door	Weight: 20.2 kg (44.5 lbs)	
4 DST	Stand	Size: 57 x 43 x 26 cm (22.5 x 17 x 10.25")	
1 DH2	Wall holder		

K12S Standard 100 W / 12 V Tungsten Kit *(items in bold are in addition to basic kit)*

4 DLH4	Light head aspherics ²	1 DSTFX	Flexible stand extension
1 DT12-4	Power supply 4 x 12V	2 DH2	Wall holder
6 DPOW3	Light head cable 8 m (26.2')	2 CLAMP1	Clamp
1 DXBAT4-3	Battery cable	1 DV6B	Vacuum mount
1 DCAR3	Cigarette lighter adapter	8 DL100	Halogen lamp 12V / 100W
4 DBD8	Barn door	2 DL50	Halogen lamp 12V / 50W
2 DPLS	Light shield ring	2 DL20	Halogen lamp 12V / 20W
4 DFH	Filter holder	2 DLBOX	Plastic box
1 DGMD	Gel filter set – mixed diffusion	1 DCHD	Transport hard case
1 DGMB	Gel filter set – mixed blue	Weight: 22.3 kg (49.1 lbs)	
4 DST	Stand	Size: 57 x 43 x 26 cm (22.5 x 17 x 10.25")	

K12M Master 100 W / 12 V Tungsten Kit *(items in bold are in addition to standard kit)*

4 DLH4	Light head aspherics ²
1 DT12-4	Power supply 4 x 12V
6 DPOW3	Light head cable 8 m (26.2')
1 DXBAT4-3	Battery cable
1 DCAR3	Cigarette lighter adapter
4 DBD8	Barn door
4 DPLS	Light shield ring
4 DDCF	Dichroic daylight conversion filter
4 DFH	Filter holder
1 DGMB	Gel filter set – mixed blue
1 DGMD	Gel filter set – mixed diffusion
1 DGW	Gel filter set – warm tone
4 DST	Stand
2 DSTFX	Flexible stand extension
2 DH2	Wall holder
2 CLAMP1	Clamp
1 DV6B	Vacuum mount
10 DL100	Halogen lamp 12V / 100W
4 DL50	Halogen lamp 12V / 50W
4 DL20	Halogen lamp 12V / 20W
3 DLBOX	Plastic box
1 DCHD	Transport hard case
Weight: 22.6 kg (49.8 lbs)	
Size: 57 x 43 x 26 cm (22.5 x 17 x 10.25")	



K24 150 W/24 V Tungsten Kits

One DT24-3 master control unit operates three DLH4 light heads with 24V / 150W lamps. Input voltage on the control unit can be adjusted from 100 to 255V AC. Color temperature and intensity is switchable in three calibrated steps for each light head.

K24B Basic 150 W/ 24 V Tungsten Kit

3	DLH4	Light head aspherics ²	6	DL150	Halogen lamp 24V / 150W
1	DT24-3	Power supply 3 x 24V	1	DLBOX	Plastic box
3	DPOW3	Light head cable 8 m (26.2')	1	DCHD	Transport hard case
3	DBD8	Barn door	Weight: 17.3 kg (38.4 lbs)		
3	DST	Stand	Size: 57 x 43 x 26 cm (22.5 x 17 x 10.25")		

K24S Standard 150 W/ 24 V Tungsten Kit *(items in bold are in addition to basic kit)*

3	DLH4	Light head aspherics ²	1	CLAMP1	Clamp
1	DT24-3	Power supply 3 x 24V	1	DV6B	Vacuum mount
6	DPOW3	Light head cable 8 m (26.2')	6	DL150	Halogen lamp 24V / 150W
3	DBD8	Barn door	2	DLBOX	Plastic box
2	DPLS	Light shield ring	1	DCHD	Transport hard case
3	DDCF	Dichroic daylight conversion filter	Weight: 20.0 kg (44.0 lbs)		
3	DFH	Filter holder	Size: 57 x 43 x 26 cm (22.5 x 17 x 10.25")		
1	DGMD	Gel filter set – mixed diffusion			
3	DST	Stand			
1	DSTFX	Flexible stand extension			
2	DH2	Wall holder			

K24M Master 150 W / 24 V Tungsten Kit *(items in bold are in addition to standard kit)*

3	DLH4	Light head aspherics ²
1	DT24-3	Power supply 3 x 24V
6	DPOW3	Light head cable 8 m (26.2')
3	DBD8	Barn door
3	DPLS	Light shield ring
3	DDCF	Dichroic daylight conversion filter
1	DSCK	Scrim kit
1	DSCP	Scrim pouch
1	DGRADF06	Graduated glass filter (ND 0.6)
3	DFH	Filter holder
1	DGW	Gel filter set – warm tone
1	DGMD	Gel filter set – mixed diffusion
1	DP1	Imager projection attachment
1	DPGH	Gobo holder
1	DPFS	Framing shutter blades
1	DPIR	Iris
3	DST	Stand
2	DSTFX	Flexible stand extension
2	DH2	Wall holder
2	CLAMP1	Clamp
1	DV6B	Vacuum mount
10	DL150	Halogen lamp 24V / 150W
3	DLBOX	Plastic box
1	DCHD	Transport hard case

Weight: 21.0 kg (46.3 lbs), Size: 57 x 43 x 26 cm (22.5 x 17 x 10.25")



HARD CASE TUNGSTEN CLASSIC

KAC24 150 W/ 24 V Tungsten Kits

Four DLHM4-300 light heads with integrated, dimmable, electronic transformers work with 24V / 150W lamps. The DLHM4-300 light heads are available in four different mains voltage versions:

DLHM4-300E (Europe) 230V AC, **DLHM4-300E+** (Australia) 240V AC, **DLHM4-300U** (USA) 117V AC, **DLHM4-300J** (Japan) 100V AC

KAC24B Basic 150 W/ 24 V Tungsten Kit

4 DLHM4-300	Light head aspherics ² w/ built-in dimmable electronic power supply 24V, 3m (9.8') USA / 4m (13.1') EU cable	1 CLAMP1	Clamp
4 DBD8	Barn door	6 DL150	Halogen lamp 24V / 150W
4 DST	Stand	1 DLBOX	Plastic box
1 DH2	Wall holder	1 DCHDM4	Transport hard case
		Weight: 14.7 kg (32.4 lbs)	
		Size: 57 x 43 x 22 cm (22.5 x 17 x 8.7")	

KAC24S Standard 150 W/ 24 V Tungsten Kit *(items in bold are in addition to basic kit)*

4 DLHM4-300	Light head aspherics ² w/ built-in dimmable electronic power supply 24V, 3m (9.8') USA / 4m (13.1') EU cable	1 DPIP	Iris
4 DBD8	Barn door	4 DST	Stand
2 DPLS	Light shield ring	1 DSTFX	Flexible stand extension
4 DDCF	Dichroic daylight conversion filter	2 DH2	Wall holder
4 DFH	Filter holder	2 CLAMP1	Clamp
1 DGMD	Gel filter set – mixed diffusion	8 DL150	Halogen lamp 24V / 150W
1 DP1	Imager projection attachment	3 DLBOX	Plastic box
1 DPGH	Gobo holder	1 DCHDM4	Transport hard case
1 DPFS	Framing shutter blades	Weight: 15.8 kg (34.9 lbs)	
		Size: 57 x 43 x 22 cm (22.5 x 17 x 8.7")	

KAC24M Master 150 W/ 24 V Tungsten Kit *(items in bold are in addition to standard kit)*

4 DLHM4-300	Light head aspherics ² w/ built-in dimmable electronic power supply 24V, 3m (9.8') USA / 4m (13.1') EU cable
4 DBD8	Barn door
4 DPLS	Light shield ring
4 DDCF	Dichroic daylight conversion filter
1 DSCK	Scrim kit
1 DSCP	Scrim pouch
1 DGRADF06	Graduated glass filter (ND 0.6)
4 DFH	Filter holder
1 DGMD	Gel filter set – mixed diffusion
1 DGW	Gel filter set – warm tone
1 DP1	Imager projection attachment
1 DPGH	Gobo holder
1 DPFS	Framing shutter blades
1 DPIP	Iris
4 DST	Stand
2 DSTFX	Flexible stand extension
2 DH2	Wall holder
2 CLAMP1	Clamp
1 DV6B	Vacuum mount
10 DL150	Halogen lamp 24V / 150W
3 DLBOX	Plastic box
1 DCHDM4	Transport hard case
Weight: 16.8 kg (37.0 lbs)	
Size: 57 x 43 x 22 cm (22.5 x 17 x 8.7")	



KA1 100W/ 12V Tungsten Kits 230V AC

Four DLH4 light heads work with dimmable, in-line, electronic DIMTA3 power supplies and 12V / 100W DL100 lamps.

KA1B Basic 100W / 12V Tungsten Kits 230V AC

4 DLH4	Light head aspherics ²	6 DL100	Halogen lamp 12V / 100W
4 DIMTA3	Dimmable electronic power supply 12V / 230V AC	1 DLBOX	Plastic box
4 DBD8	Barn door	1 DCHDM4	Transport hard case
4 DST	Stand	Weight: 10.8 kg (23.8 lbs)	
1 DH2	Wall holder	Size: 57x43x22 cm (22.5x17x8.7")	
1 CLAMP1	Clamp		

KA1S Standard 100W/ 12V Tungsten Kits 230V AC

(items in bold are in addition to basic kit)

4 DLH4	Light head aspherics ²	4 DST	Stand
4 DIMTA3	Dimmable electronic power supply 12V / 230V AC	1 DSTFX	Flexible stand extension
4 DBD8	Barn door	2 DH2	Wall holder
4 DFH	Filter holder	1 CLAMP1	Clamp
1 DGMB	Gel filter set – mixed blue	8 DL100	Halogen lamp 12V / 100W
1 DGMD	Gel filter set – mixed diffusion	2 DLBOX	Plastic box
1 DP1	Imager projection attachment	1 DCHDM4	Transport hard case
1 DPGH	Gobo holder	Weight: 11.7 kg (25.7 lbs)	
1 DPFS	Framing shutter blades	Size: 57x43x22 cm (22.5x17x8.7")	
1 DPIR	Iris		

KA1M Master 100W/ 12V Tungsten Kits 230V AC

(items in bold are in addition to standard kit)

4 DLH4	Light head aspherics ²
4 DIMTA3	Dimmable electronic power supply 12V / 230V AC
4 DBD8	Barn door
4 DFH	Filter holder
1 DGMB	Gel filter set – mixed blue
1 DGMD	Gel filter set – mixed diffusion
1 DGW	Gel filter set – warm tone
1 DP1	Imager projection attachment
1 DPGH	Gobo holder
1 DPFS	Framing shutter blades
1 DPIR	Iris
4 DST	Stand
2 DSTFX	Flexible stand extension
2 DH2	Wall holder
2 CLAMP1	Clamp
1 DV6B	Vacuum mount
10 DL100	Halogen lamp 12V / 100W
3 DLBOX	Plastic box
1 DCHDM4	Transport hard case
Weight: 12.5 kg (27.4 lbs)	
Size: 57x43x22 cm (22.5x17x8.7")	



HARD CASE TUNGSTEN CLASSIC

KA24 150 W / 24 V Tungsten Kits

Three DLH4 light heads work with in-line, dimmable DT24-1 power supplies to be used with 24V / 150W DL150 lamps. The DT24-1 in-line power supplies are available for three different mains voltages:

DT24-1E (Europe) 230/240V AC, DT24-1U (USA) 117V AC, DT24-1J (Japan) 100V AC

KA24B Basic 150 W / 24 V Tungsten Kit

3 DLH4	Light head aspherics ²	6 DL150	Halogen lamp 24V / 150W
3 DT24-1	Dimmable electronic power supply 24V	1 DLBOX	Plastic box
3 DBD8	Barn door	1 DCHDKA1	Transport hard case
3 DST	Stand	Weight: 13.3 kg (29.3 lbs),	
1 DH2	Wall holder	Size: 58 x 43 x 27 cm (22.8 x 17 x 10.6")	
1 CLAMP1	Clamp		

KA24S Standard 150 W / 24 V Tungsten Kit *(items in bold are in addition to basic kit)*

3 DLH4	Light head aspherics ²	3 DST	Stand
3 DT24-1	Dimmable electronic power supply 24V	1 DSTFX	Flexible stand extension
3 DBD8	Barn door	2 DH2	Wall holder
2 DPLS	Light shield ring	2 CLAMP1	Clamp
3 DDCF	Dichroic daylight conversion filter	8 DL150	Halogen lamp 24V / 150W
3 DFH	Filter holder	2 DLBOX	Plastic box
1 DGMD	Gel filter set – mixed diffusion	1 DCHDKA1	Transport hard case
1 DP1	Imager projection attachment	Weight: 14.4 kg (31.7 lbs),	
1 DPGH	Gobo holder	Size: 58 x 43 x 27 cm (22.8 x 17 x 10.6")	
1 DPFS	Framing shutter blades		
1 DPIR	Iris		

KA24M Master 150 W / 24 V Tungsten Kit *(items in bold are in addition to standard kit)*

3 DLH4	Light head aspherics ²
3 DT24-1	Dimmable electronic power supply 24V
3 DBD8	Barn door
3 DPLS	Light shield ring
3 DDCF	Dichroic daylight conversion filter
1 DGRADF06	Graduated glass filter (ND 0.6)
4 DFH	Filter holder
1 DGMD	Gel filter set – mixed diffusion
1 DGW	Gel filter set – warm tone
1 DP1	Imager projection attachment
1 DPGH	Gobo holder
1 DPFS	Framing shutter blades
1 DPIR	Iris
3 DST	Stand
2 DSTFX	Flexible stand extension
2 DH2	Wall holder
2 CLAMP1	Clamp
1 DV6B	Vacuum mount
10 DL150	Halogen lamp 24V / 150W
2 DLBOX	Plastic box
1 DCHDKA1	Transport hard case
Weight: 14.5 kg (32.1 lbs),	
Size: 58 x 43 x 27 cm (22.8 x 17 x 10.6")	



KA24-4 150 W / 24 V Tungsten Kits

These kits come with four DLH4 light heads and four in-line, dimmable DT24-1 power supplies to be used with 24 V / 150 W DL150 lamps. The DT24-1 in-line power supplies are available for three different mains voltages:

DT24-1E (Europe) 230/240V AC, **DT24-1U** (USA) 117V AC, **DT24-1J** (Japan) 100V AC

KA24-4B Basic Four Light 150 W/ 24 V Kit

4 DLH4	Light head aspherics ²	1 DH2	Wall holder
4 DT24-1	Dimmable electronic power supply 24V	1 CLAMP1	Clamp
4 DBD8	Barn door	8 DL150	Halogen lamp 24V / 150W
4 DPLS	Light shield ring	2 DLBOX	Plastic box
4 DFH	Filter holder	1 DCHDKA1	Transport hard case
4 DST	Stand	Weight: 15.2 kg (33.4 lbs),	
1 DSTFX	Flexible stand extension	Size: 58 x 43 x 27 cm (22.8 x 17 x 10.6 ")	

KA24-4M Master Four Light 150 W/ 24 V Kit *(items in bold are in addition to basic kit)*

4 DLH4	Light head aspherics ²
4 DT24-1	Dimmable electronic power supply 24V
4 DBD8	Barn door
4 DPLS	Light shield ring
4 DFH	Filter holder
1 DP1	Imager projection attachment
1 DPGH	Gobo holder
1 DPFS	Framing shutter blades
1 DPIR	Iris
4 DST	Stand
1 DSTFX	Flexible stand extension
1 DH2	Wall holder
2 CLAMP1	Clamp
8 DL150	Halogen lamp 24V / 150W
2 DLBOX	Plastic box
1 DCHDKA1	Transport hard case
Weight: 15.7 kg (34.6 lbs),	
Size: 58 x 43 x 27 cm (22.8 x 17 x 10.6 ")	



dedolight SuperMax Kit

The SuperMax kit is ideal when shooting commercials, table top and product photography where special effects are to be created with projection attachments. A two case combination of the K12 master lighting kit and the KX accessory kit. A full array of projection attachments, lenses and numerous accessories are included.

Case 1: K12M Master 100W/12V Tungsten Kit

4 DLH4	Light head aspherics ²	4 DST	Stand
1 DT12-4	Power supply 4x 12V	2 DSTFX	Flexible stand extension
6 DPOW3	Light head cable 8 m (26.2')	2 DH2	Wall holder
1 DXBAT4-3	Battery cable	2 CLAMP1	Clamp
1 DCAR3	Cigarette lighter adapter	1 DV6B	Vacuum mount
4 DBD8	Barn door	10DL100	Halogen lamp 12V / 100W
4 DPLS	Light shield ring	4 DL50	Halogen lamp 12V / 50W
4 DDCF	Dichroic daylight conversion filter	4 DL20	Halogen lamp 12V / 20W
4 DFH	Filter holder	3 DLBOX	Plastic box
1 DGMB	Gel filter set – mixed blue	1 DCHD	Transport hard case
1 DGMD	Gel filter set – mixed diffusion		
1 DGW	Gel filter set – warm tone		
		Weight: 22.6 kg (49.8 lbs),	
		Size: 57x43x26 cm (22.5x17x10.3")	

Case 2: KX Accessory Kit

1 DP1	Imager projection attachment	1 DGMB8	Gel filter set – mixed blue
2 DP2	Single function imager projection attachment	1 DGB8	Gel filter set – blue
1 DP3	Imager projection attachment for slides	1 DGMD	Gel filter set – mixed diffusion
1 DPL60M	Projection lens, 60 mm	1 DGW	Gel filter set – warm tone
1 DPLZ120M	Zoom lens, 70 – 120 mm	1 DGCOL8	Gel filter set – color effect
1 DPLZ150M	Zoom lens, 85 – 150 mm	1 DGND8	Gel filter set – neutral density
1 DPL185M	Projection lens, 185 mm	4 DPEYESET	Eye attachment
1 DPX	Extension tube	4 DPEYEP	Pouch for DPEYESET
1 DPFS	Framing shutter blades	3 DLBOX	Plastic box
1 DPIR	Iris	4 DSCK	Scrim kit
3 DPGH	Gobo holder	4 DSCP	Scrim pouch
4 DFH	Filter holder	1 DCHDX	Transport hard case
2 DGRADF06	Graduated glass filter (ND 0.6)		
2 DGRADF09	Graduated glass filter (ND 0.9)	Weight: 9.8 kg (21.6 lbs),	
		Size: 57x43x22 cm (22.5x17x8.7")	



SOFT CASE TUNGSTEN CLASSIC

SM12 Mono 100 W / 12 V Tungsten Kit

- 1 DLH4 Light head aspherics²
 - 1 DIMTA3 Dimmable electronic power supply
12 V/230 V AC
 - 1 DBD8 Barn door
 - 1 DFH Filter holder
 - 2 DL100 Halogen lamp 12 V/100 W
 - 1 DSCM Soft case
- Weight: 2.0 kg (4.3 lbs)
Size: 28 x 17 x 25 cm (11 x 6.7 x 10")



SM24-1 Mono 150 W / 24 V Tungsten Kit

- 1 DLH4 Light head aspherics²
 - 1 DT24-1 Dimmable electronic power supply 24 V
230/240 V AC version, add suffix E
117 V AC version, add suffix U
100 V AC version, add suffix J
 - 1 DBD8 Barn door
 - 1 DFH Filter holder
 - 2 DL150 Halogen lamp 24 V/150 W
 - 1 DSCM Soft case
- Weight: 2.1 kg (4.7 lbs)
Size: 28 x 17 x 25 cm (11 x 6.7 x 10")



SM24-300 Mono 150 W / 24 V Tungsten Kit

- 1 DLHM4-300 Light head aspherics² w/ built-in
dimmable electronic power supply 24 V,
3 m (9.8') USA / 4 m (13.1') EU cable
230 V AC version, add suffix E
240 V AC version, add suffix E+
117 V AC version, add suffix U
100 V AC version add suffix J
 - 1 DBD8 Barn door
 - 1 DFH Filter holder
 - 2 DL150 Halogen lamp 24 V / 150 W
 - 1 DSCM Soft case
- Weight: 2.1 kg (4.5 lbs)
Size: 28 x 17 x 25 cm (11 x 6.7 x 10")



SOFT CASE TUNGSTEN CLASSIC

SM24P Mono 150 W / 24 V Tungsten Kit

- 1 DLHM4-300 Light head aspherics² w/ built-in dimmable electronic power supply 24 V, 3 m (9.8') USA / 4 m (13.1') EU cable add suffix E, E+, U or J
- 1 DBD8 Barn door
- 1 DFH Filter holder
- 2 DL150 Halogen lamp 24 V / 150 W
- 1 DP1 Imager projection attachment
- 1 DPGH Gobo holder
- 1 DPFS Framing shutter blades
- 1 DSCM Soft case

Weight: 2.6 kg (5.6 lbs)

Size: 28 x 17 x 25 cm (11 x 6.7 x 10")



SBABE-S Standard Baby Soft Kit

- 1 DLH1x150S Soft light head 100/150 W
- 1 HTP150S High temperature pouch
- 1 DSBSXS Mini soft box, silver
- 1 DLGRIDXS Mini grid
- 1 DT24-1 Dimmable electronic power supply 24 V
- 2 DL150-NB Halogen lamp 24 V / 150 W
- 1 DSC150S Soft bag

Weight: 1,9 kg (4.2 lbs), Size: 48 x 13 x 20 cm (19 x 5.1 x 8")

SBABE-B Basic Baby Soft Kit same as above but without DLGRIDXS and HTP150S. Weight: 1,8 kg (4.0 lbs)



SJUN-S Standard Junior Soft Kit

- 1 DLH1x300S Soft light head 300 W halogen with 3 m (9.8') cable
- 1 HTP300S High temperature pouch
- 1 DSBS Silver dome small
- 1 DLGRIDS Grid small
- 2 DL300FSL-NB Lamp 230 V / 300 W *
- 1 DST Stand
- 1 DSC300S Soft bag

Weight: 3,9 kg (8.6 lbs), Size: 65 x 17 x 24 cm (25.6 x 6.7 x 9.4")

SJUN-B Basic Junior Soft Kit same as above but without DLGRIDS and HTP300S. Weight: 3,8 kg (8.4 lbs)

*option: DL300FKW-NB Lamp 120 V / 300 W

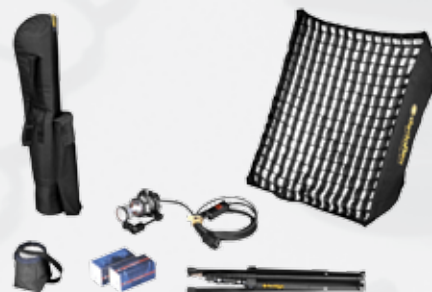

SSEN-S Standard Senior Soft Kit

- 1 DLH1000S Soft light head 1000 W halogen with 3 m (9.8') cable
- 1 HTP1000S High temperature pouch
- 1 DSBSM Silver dome medium
- 1 DLGRIDM Grid medium
- 2 DL1000FEP-NB Lamp 230/240 V / 1000 W *
- 1 DST Stand
- 1 DSC1000S Soft bag

Weight: 4,0 kg (8.8 lbs), Size: 75 x 17 x 24 cm (29.5 x 6.7 x 9.4")

SSEN-B Basic Senior Soft Kit same as above but without DLGRIDM, HTP1000S. Weight: 3,9 kg (8.6 lbs)

*option: DL1000FEL-NB Lamp 120 V / 1000 W



The Compact

The smallest most compact three light kits which are ideal for the very small mobile video crew. Two dimmable focusing lights of which one may also be used with battery operation along with the DLH1000S soft light are included. These kits will cover your basic interview needs.

S1B Basic Compact-Kit

1 DLH4	Light head aspherics ²	1 DGMD	Gel filter set – mixed diffusion
1 DLHM4-300	Light head aspherics ² w/ built-in dimmable electronic power supply 24V, 3 m (9.8') USA / 4 m (13.1') EU cable	3 DST	Stand
1 DLH1000S	Soft light head 1000W halogen with 3 m (9.8') cable	4 DL150	Halogen lamp 24V/150W
1 HTP1000S	High temperature pouch	2 DL100	Halogen lamp 12V/100W
1 DSBSS	Silver dome, small	1 DL800HX-NB	Lamp 230 / 240V/800W *
1 DT24-1	Dimmable electronic power supply 24V	1 DLBOX	Plastic box
1 DXBAT4-3	Battery cable	1 DSC1/1-200	Soft case, small
1 DCAR3	Cigarette lighter adapter	Weight: 10.1 kg (22.3 lbs),	
2 DBD8	Barn door	Size: 65 x 23 x 30 cm (25.6 x 9.1 x 11.8")	
2 DFH	Filter holder	*option: DL750EHF-NB Lamp 120V/750W	

S1S Standard Compact Kit *(items in bold are in addition to basic kit)*

1 DLH4	Light head aspherics ²	1 DPGH	Gobo holder
1 DLHM4-300	Light head aspherics ² w/ built-in dimmable power supply 24V, 3 m (9.8') USA / 4 m (13.1') EU cable	1 DPFS	Framing shutter blades
1 DLH1000S	Soft light head 1000W halogen	3 DST	Stand
1 HTP1000S	High temperature pouch	1 DSTFX	Flexible stand extension
1 DSBSS	Silver dome, small	6 DL150	Halogen lamp 24V / 150W
1 DT24-1	Dimmable electronic power supply 24V	2 DL100	Halogen lamp 12V / 100W
1 DXBAT4-3	Battery cable	1 DL800HX-NB	Lamp 230 / 240V / 800W *
1 DCAR3	Cigarette lighter adapter	2 DLBOX	Plastic box
2 DBD8	Barn door	1 DSC1/1-200	Soft case, small
2 DFH	Filter holder	Weight: 10.7 kg (23.6 lbs)	
1 DGMD	Gel filter set – mixed diffusion	Size: 65 x 23 x 30 cm (25.6 x 9.1 x 11.8")	
1 DP1	Imager projection attachment	*option: DL750EHF-NB Lamp 120V/750W	

S1M Master Compact Kit *(items in bold are in addition to standard kit)*

1 DLH4	Light head aspherics ²		
1 DLHM4-300	Light head aspherics ² w/ built-in dimmable power supply 24V, 3 m (9.8') USA / 4 m (13.1') EU cable		
1 DLH1000S	Soft light head 1000W halogen		
1 HTP1000S	High temperature pouch		
1 DSBSS	Silver dome, small		
1 DLGRIDS	Grid, small		
1 DT24-1	Dimmable electronic power supply 24V		
1 DXBAT4-3	Battery cable		
1 DCAR3	Cigarette lighter adapter		
2 DBD8	Barn door		
2 DPLS	Light shield ring	2 DL100	Halogen lamp 12V / 100W
2 DDCF	Dichroic daylight conversion filter	2 DL800HX-NB	Lamp 230 / 240V / 800W *
1 DSCK	Scrim kit	3 DLBOX	Plastic box
1 DSCP	Scrim pouch	1 DSC1/1-200	Soft case, small
2 DFH	Filter holder	Weight: 11.2 kg (24.7 lbs)	
1 DGMD	Gel filter set – mixed diffusion	Size: 65 x 23 x 30 cm (25.6 x 9.1 x 11.8")	
1 DP1	Imager projection attachment	*option: DL750EHF-NB Lamp 120V/750W	
2 DPGH	Gobo holder		
1 DPFS	Framing shutter blades		
3 DST	Stand		
1 DSTFX	Flexible stand extension		
2 CLAMP1	Clamp		
6 DL150	Halogen lamp 24V / 150W		

The Traveler

These four light Traveler kits allow an elaborate interview and documentary style of lighting. Three dimmable focusing lights of which one may also be used with battery operation along with the DLH1000S soft light are included.

S2B Basic Traveler Kit

1 DLH4	Light head aspherics ²	3 DFH	Filter holder
2 DLHM4-300	Light head aspherics ² w/ built-in dimmable electronic power supply 24V, 3m (9.8') USA / 4m (13.1') EU cable	1 DGMD	Gel filter set – mixed diffusion
1 DLH1000S	Soft light head 1000W halogen with 3m (9.8') cable	4 DST	Stand
1 HTP1000S	High temperature pouch	6 DL150	Halogen lamp 24V / 150W
1 DSBSM	Silver dome, medium	2 DL100	Halogen lamp 12V / 100W
1 DT24-1	Dimmable electronic power supply 24V	1 DL1000FEP-NB	Lamp 230 / 240V / 1000W *
1 DXBAT4-3	Battery cable	1 DLBOX	Plastic box
1 DCAR3	Cigarette lighter adapter	1 DSC2/2-200	Soft case, medium
3 DBD8	Barn door		

Weight: 13.0 kg (28.6 lbs)
 Size: 83 x 30 x 33 cm (32.7 x 11.8 x 13")
 *option: DL1000FEL-NB Lamp 120V/1000W

S2S Standard Traveler Kit *(items in bold are in addition to basic kit)*

1 DLH4	Light head aspherics ²	4 DST	Stand
2 DLHM4-300	Light head aspherics ² w/ built-in dimmable power supply 24V, 3m (9.8') USA / 4m (13.1') EU cable	1 DSTFX	Flexible stand extension
1 DLH1000S	Soft light head 1000W halogen	1 CLAMP1	Clamp
1 HTP1000S	High temperature pouch	6 DL150	Halogen lamp 24V / 150W
1 DSBSM	Silver dome, medium	2 DL100	Halogen lamp 12V / 100W
1 DT24-1	Dimmable power supply 24V	1 DL1000FEP-NB	Lamp 230 / 240V / 1000W *
1 DXBAT4-3	Battery cable	2 DLBOX	Plastic box
1 DCAR3	Cigarette lighter adapter	1 DSC2/2-200	Soft case, medium
3 DBD8	Barn door		
3 DPLS	Light shield ring		
3 DFH	Filter holder		
1 DGMD	Gel filter set – mixed diffusion		

Weight: 13.3 kg (29.3 lbs)
 Size: 83 x 30 x 33 cm (32.7 x 11.8 x 13")
 *option: DL1000FEL-NB Lamp 120V/1000W

S2M Master Traveler Kit *(items in bold are in addition to standard kit)*

1 DLH4	Light head aspherics ²	2 DSTFX	Flexible stand extension
2 DLHM4-300	Light head aspherics ² w/ built-in dimmable power supply 24V, 3m (9.8') USA / 4m (13.1') EU cable	1 DH2	Wall holder
1 DLH1000S	Soft light head 1000W halogen	2 CLAMP1	Clamp
1 HTP1000S	High temperature pouch	6 DL150	Halogen lamp 24V / 150W
1 DSBSM	Silver dome, medium	2 DL100	Halogen lamp 12V / 100W
1 DLGRIDM	Grid, medium	2 DL1000FEP-NB	Lamp 230 / 240V / 1000W *
1 DFT30	Diffuser translucent	3 DLBOX	Plastic box
1 DLTFH	Compact dedoflex holder	1 DSC2/2-200	Soft case, medium
1 DT24-1	Dimmable power supply 24V		
1 DXBAT4-3	Battery cable		
1 DCAR3	Cigarette lighter adapter		
3 DBD8	Barn door		
3 DPLS	Light shield ring		
3 DDCF	Dichroic daylight conversion filter		
1 DSCK	Scrim kit		
1 DSCP	Scrim pouch		
3 DFH	Filter holder		
1 DGMD	Gel filter set – mixed diffusion		
1 DGW	Gel filter set – warm tone		
1 DP1	Imager projection attachment		
2 DPGH	Gobo holder		
1 DPFS	Framing shutter blades		
4 DST	Stand		

Weight: 14.5 kg (32.0 lbs)
 Size: 83 x 30 x 33 cm (32.7 x 11.8 x 13")
 *option: DL1000FEL-NB Lamp 120V/1000W



The Hustler

These four light kits are designed for crews requiring extremely quick set up, but no need for battery operation and are strictly mains powered. Standard and master kits also include a diffuser and holder allowing one of the focusing light heads to be used as an additional soft source.

S3B Basic Hustler Kit

3 DLHM4-300	Light head aspherics ² w/ built-in dimmable electronic power supply 24V, 3m (9.8') USA / 4m (13.1') EU cable	4 DST	Stand
1 DLH1000S	Soft light head 1000W halogen with 3m (9.8') cable	1 DSTFX	Flexible stand extension
1 HTP1000S	High temperature pouch	6 DL150	Halogen lamp 24V / 150W
1 DSBSS	Silver dome small	1 DL800HX-NB	Lamp 230 / 240V / 800W *
3 DBD8	Barn door	1 DLBOX	Plastic box
3 DFH	Filter holder	1 DSC1/1-200	Soft case, small
1 DGMD	Gel filter set – mixed diffusion	Weight: 12.0 kg (26.5 lbs)	
		Size: 65 x 23 x 30 cm (25.6 x 9.1 x 11.8")	
		*option: DL1000FEL-NB Lamp 120V / 1000W	

S3S Standard Hustler Kit *(items in bold are in addition to basic kit)*

3 DLHM4-300	Light head aspherics ² w/ built-in dimmable power supply 24V, 3m (9.8') USA / 4m (13.1') EU cable	1 DPGH	Gobo holder
1 DLH1000S	Soft light head 1000W halogen	1 DPFS	Framing shutter blades
1 HTP1000S	High temperature pouch	4 DST	Stand
1 DSBSS	Silver dome, small	2 DSTFX	Flexible stand extension
1 DFT30	Diffuser, translucent	1 CLAMP1	Clamp
1 DLTFH	Compact dedoflex holder	6 DL150	Halogen lamp 24V / 150W
3 DBD8	Barn door	1 DL800HX-NB	Lamp 230 / 240V / 800W *
3 DPLS	Light shield ring	2 DLBOX	Plastic box
3 DFH	Filter holder	1 DSC2/2-200	Soft case, medium
1 DGMD	Gel filter set – mixed diffusion	Weight: 12.9 kg (28.4 lbs)	
1 DP1	Imager projection attachment	Size: 83 x 30 x 33 cm (32.7 x 11.8 x 13")	
		*option: DL750EHF-NB Lamp 120V / 750W	

S3M Master Hustler Kit *(items in bold are in addition to standard kit)*

3DLHM4-300	Light head aspherics ² w/ built-in dimmable power supply 24V, 3m (9.8') USA / 4m (13.1') EU cable		
1DLH1000S	Soft light head 1000W halogen		
1HTP1000S	High temperature pouch		
1DSBSM	Silver dome medium		
1DLGRIDM	Grid medium		
1DFT30	Diffuser, translucent		
1DLTFH	Compact dedoflex holder		
3DBD8	Barn door		
3DPLS	Light shield ring		
3DDCF	Dichroic daylight conversion filter		
1DSCK	Scrim kit		
1DSCP	Scrim pouch		
3DFH	Filter holder		
1DGMD	Gel filter set – mixed diffusion		
1DGW	Gel filter set – warm tone		
1DP1	Imager projection attachment		
1DPGH	Gobo holder		
1DPFS	Framing shutter blades		
1DPIR	Iris		
4DST	Stand	2CLAMP1	Clamp
2DSTFX	Flexible stand extension	6DL150	Halogen lamp 24V / 150W
1DH2	Wall holder	2DL1000FEP-NB	Lamp 230 / 240V / 1000W *
		3DLBOX	Plastic box
		1DSC2/2-200	Soft case, medium
		Weight: 14.2 kg (31.3 lbs)	
		Size: 83 x 30 x 33 cm (32.7 x 11.8 x 13")	
		*option: DL1000FEL-NB Lamp 120V / 1000W	

The Explorer

This three light kit is ideal for teams requiring mains operation and also the ability to run all three focusing heads from battery (additional adapter cables required).

With ,option 1' a soft light is added which may also be operated from mains or battery. See Powering Options section for BIGPACK batteries and DLSPLIT splitter box (Page 42).

S4B Basic Explorer Kit

3 DLH4	Light head aspherics ²	3 DST	Stand
3 DT24-1	Dimmable electronic power supply 24V	1 DSTFX	Flexible stand extension
1 DFT30	Diffuser translucent	2 CLAMP1	Clamp
1 DLTFH	Compact dedoflex holder	6 DL150	Halogen lamp 24V / 150W
1 DXBAT4-3	Battery cable	2 DL100	Halogen lamp 12V / 100W
1 DCAR3	Cigarette lighter adapter	1 DLBOX	Plastic box
3 DBD8	Barn door	1 DSC2/2-200	Soft case, medium
3 DDCF	Dichroic daylight conversion filter		Weight: 9.4 kg (20.7 lbs)
3 DFH	Filter holder		Size: 83 x 30 x 33 cm (32.7 x 11.8 x 13")
1 DGMD	Gel filter set – mixed diffusion		

S4M Master Explorer Kit *(items in bold are in addition to basic kit)*

1 DLH1x150S	Soft light head 100 / 150W
1 HTP150S	High temperature pouch
1 DSBSXS	Mini soft box, silver
3 DLH4	Light head aspherics ²
4 DT24-1	Dimmable electronic power supply 24V
1 DFT30	Diffuser translucent
1 DLTFH	Compact dedoflex holder
1 DXBAT4-3	Battery cable
1 DCAR3	Cigarette lighter adapter
3 DBD8	Barn door
3 DDCF	Dichroic daylight conversion filter
3 DFH	Filter holder
1 DGMD	Gel filter set – mixed diffusion
4 DST	Stand
1 DSTFX	Flexible stand extension
2 CLAMP1	Clamp
6 DL150	Halogen lamp 24V / 150W
2 DL150-NB	Halogen lamp 24V / 150W, non-blackened
2 DL100	Halogen lamp 12V / 100W
1 DLBOX	Plastic box
1 DSC2/2-200	Soft case, medium
Weight: 10.7 kg (23.6 lbs)	
Size: 83 x 30 x 33 cm (32.7 x 11.8 x 13")	



The Interviewer

These kits were specifically designed for interview applications. Packed in a slightly larger case with wheels for ease and mobility, they contain three mains powered focusing light heads, one soft light and space for additional equipment. Master kit also includes a diffuser and holder allowing one of the focusing light heads to be used as an additional soft source.

S5B Basic Interviewer Kit

3 DLHM4-300	Light head aspherics ² w/ built-in dimmable electronic power supply 24V, 3m (9.8') USA / 4m (13.1') EU cable	1 DGW	Gel filter set – warm tone
1 DLH1000S	Soft light head 1000W halogen with 3m (9.8') cable	1 DP1	Imager projection attachment
1 HTP1000S	High temperature pouch	1 DPGH	Gobo holder
1 DSBSM	Silver dome, medium	1 DPFS	Framing shutter blades
3 DBD8	Barn door	4 DST	Stand
3 DPLS	Light shield ring	1 DSTFX	Flexible stand extension
3 DDCF	Dichroic daylight conversion filter	1 CLAMP1	Clamp
1 DSCK	Scrim kit	6 DL150	Halogen lamp 24V / 150W
1 DSCP	Scrim pouch	1 DL1000FEP-NB	Lamp 230 / 240V / 1000W *
3 DFH	Filter holder	2 DLBOX	Plastic box
1 DGMD	Gel filter set – mixed diffusion	1 DSCXLW	Soft case, large with wheels
			Weight: 15.4 kg (34.0 lbs)
			Size: 94 x 30 x 38 cm (37 x 11.8 x 14.9")
			*option: DL1000FEL-NB Lamp 120V / 1000W

S5M Master Interviewer Kit *(items in bold are in addition to basic kit)*

3 DLHM4-300	Light head aspherics ² w/ built-in dimmable electronic power supply 24V, 3m (9.8') USA / 4m (13.1') EU cable
1 DLH1000S	Soft light head 1000W halogen with 3m (9.8') cable
1 HTP1000S	High temperature pouch
1 DSBSM	Silver dome, medium
1 DLGRIDM	Grid, medium
1 DFT30	Diffuser, translucent
1 DLTFH	Compact dedoflex holder
3 DBD8	Barn door
3 DPLS	Light shield ring
3 DDCF	Dichroic daylight conversion filter
2 DSCK	Scrim kit
2 DSCP	Scrim pouch
1 DGRADF06	Graduated glass filter (ND 0.6)
3 DFH	Filter holder
1 DGMD	Gel filter set – mixed diffusion
1 DGW	Gel filter set – warm tone
1 DP1	Imager projection attachment
3 DPGH	Gobo holder
1 DPFS	Framing shutter blades
1 DPIR	Iris
4 DST	Stand
2 DSTFX	Flexible stand extension
1 DH2	Wall holder
2 CLAMP1	Clamp
6 DL150	Halogen lamp 24V / 150W
3 DL1000FEP-NB	Lamp 230 / 240V / 1000W *
2 DLBOX	Plastic box
1 DSCXLW	Soft case, large with wheels

Weight: 16.1 kg (35.4 lbs)

Size: 94 x 30 x 38 cm (37 x 8.3 x 14.6")

***option: DL1000FEL-NB Lamp 120V / 1000W**



Battery belt kits

KOB84-2 On-Board Battery Kit

1 DLOBA ²	On-board light head
1 DLHAND	Handle
1 DLSA	Stand adapter
1 DLBAT84-2	Battery belt NiMH
1 DLOBA ² -XLR	Cable 4-pin XLR
1 DT12DC	AC power supply, 90-260V AC
4 DL100	Halogen lamp 12V / 100W
2 DL50	Halogen lamp 12V / 50W
2 DL20	Halogen lamp 12V / 20W
1 DCBAT	Transport case

Weight: 6 kg (13.2 lbs)

Size: 47 x 36 x 15 cm (18.5 x 14.2 x 5.9")



KOB84-13 On-Board Battery Kit

1 DLOBA ²	On-board light head	4 DL75	Halogen lamp 12V / 75W
1 DLHAND	Handle	2 DL50	Halogen lamp 12V / 50W
1 DLSA	Stand adapter	2 DL20	Halogen lamp 12V / 20W
1 DLBAT84-13	Battery belt NiMH	1 DCBAT	Transport case
1 DLOBA ² -XLR	Cable 4-pin XLR		
1 DT12DC	AC power supply, 90-260V AC		

Weight: 7 kg (15.4 lbs)

Size: 47 x 36 x 15 cm (18.5 x 14.2 x 5.9")

KBAT84-2 Battery Kit

1 DLH4	Light head	1 DXBAT4-3	Battery cable
1 DBD8	Barn door	1 DT12DC	AC power supply, 90-260V AC
1 DFH	Filter holder	4 DL100	Halogen lamp 12V / 100W
1 DGB	Gel filter set—full blue	2 DL50	Halogen lamp 12V / 50W
1 DLUMT	Universal mount	2 DL20	Halogen lamp 12V / 20W
1 DLCLAMP	Camera clamp	1 DCBAT	Transport case
1 DLHAND	Handle		
1 DLSA	Stand adapter		
1 DLBAT84-2	Battery belt NiMH		

Weight: 6 kg (13.2 lbs)

Size: 47 x 36 x 15 cm (18.5 x 14.2 x 5.9")

KBAT84-13 Battery Kit

1 DLH4	Light head	1 DXBAT4-3	Battery cable
1 DBD8	Barn door	1 DT12DC	AC power supply, 90-260V AC
1 DFH	Filter holder	4 DL100	Halogen lamp 12V / 100W
1 DGB	Gel filter set—full blue	2 DL50	Halogen lamp 12V / 50W
1 DLUMT	Universal mount	2 DL20	Halogen lamp 12V / 20W
1 DLCLAMP	Camera clamp	1 DCBAT	Transport case
1 DLHAND	Handle		
1 DLSA	Stand adapter		
1 DLBAT84-13	Battery belt NiMH		

Weight: 7 kg (15.4 lbs)

Size: 47 x 36 x 15 cm (18.5 x 14.2 x 5.9")

Options for KOB84:

- Option E: All belts available with built-in electronic discharge guard
- Option ED: All belts available with built-in electronic discharge guard and dimmer

Options for KBAT84:

- Option E: All belts available with electronic discharge guard
- Option ED: All belts available with electronic discharge guard and built-in dimmer

SOFT BOX OPTIONS

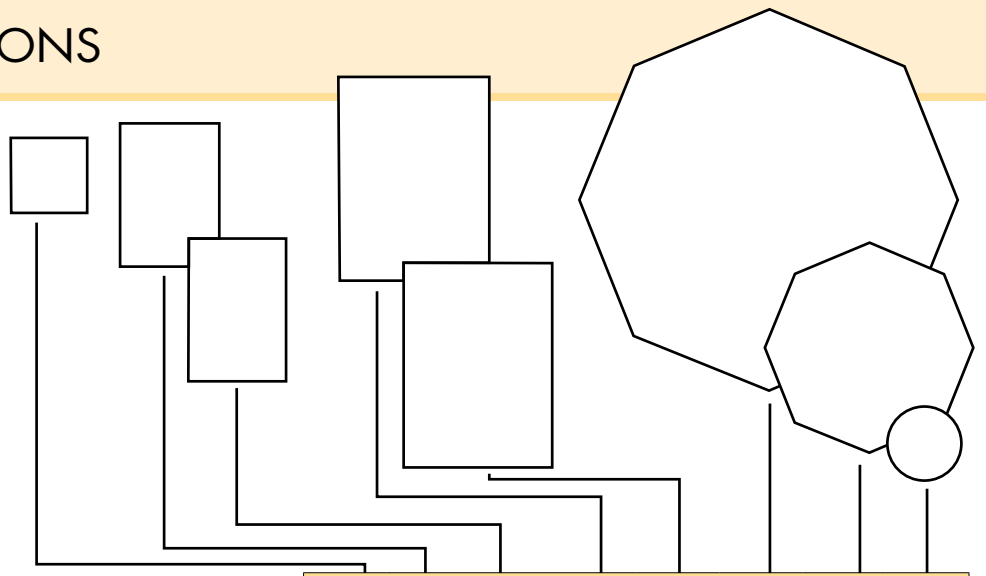

Legend:

- Direct fit
- DLSR1 dedolight speed ring, Ø 119 mm
- DLSR2 dedolight speed ring, Ø 160 mm
- DLSR8 dedolight speed ring, Ø 119 mm with 8 rod receptors
- DLSR70 dedolight mini speed ring, Ø 90 mm
- RE1 rod extensions 52 mm
- RE2 rod extensions 74 mm
- RE3 rod extensions 210 mm
- RE4 rod extensions 300 mm
- [●] max. 800 W lamp
- (●) soft box without inner diffuser
- * Dif. diffuser/light emitting surface
- ** Depth distance from diffuser* to connector/speed ring

	DEDOFLEX							
	DSBSXS Silver/Mini Dif. *: 30x30 cm; Depth **: 30 cm	DSBSS Silver Dome Small Dif. *: 41 x 56 cm; Depth **: 33 cm	DSBWS White Dome Small Dif. *: 41 x 56 cm; Depth **: 33 cm	DSBSM Silver Dome Medium Dif. *: 61 x 81 cm; Depth **: 43 cm	DSBWM White Dome Medium Dif. *: 61 x 81 cm; Depth **: 43 cm	DIPA5 (DSBOCT) PanAura®/Octadome 5 Dif. *: Ø 152 cm; Depth **: 40.5 cm	DIPA3 (DSBOCTS) PanAura®/Octadome 3 Dif. *: Ø 83 cm; Depth **: 34,5 cm	DFT30 Collapsible Diffuser Dif. *: Ø 30 cm
DLH4 DLHM4-300 DLH200DT	DLSR70							DLTFH
DLH1x150S	●	●	●	●	●			
DLH1x300S	(●)	●	●	●	●			
DLH200SDT		●	●	●	●		●	
DLH400DT DLH436 DLH650				DLSR1	DLSR1			
DLH400SDT		●	●	●	●	●		
DLH4x150S				●	●	●		
DLH1000S		[●]	[●]	●	●			
DLH1000SPUS		[●]	[●]	●	●	●		
DPAR-0 with DPAR-R								
DPAR-0 with DPAR-S		DLSR1	DLSR1	DLSR1	DLSR1	DLSR8		
Grids		DLGRIDS		DLGRIDM		DIPA5G (DLGRIDDOCT)	DIPA3G (DLGRIDDOCTS)	

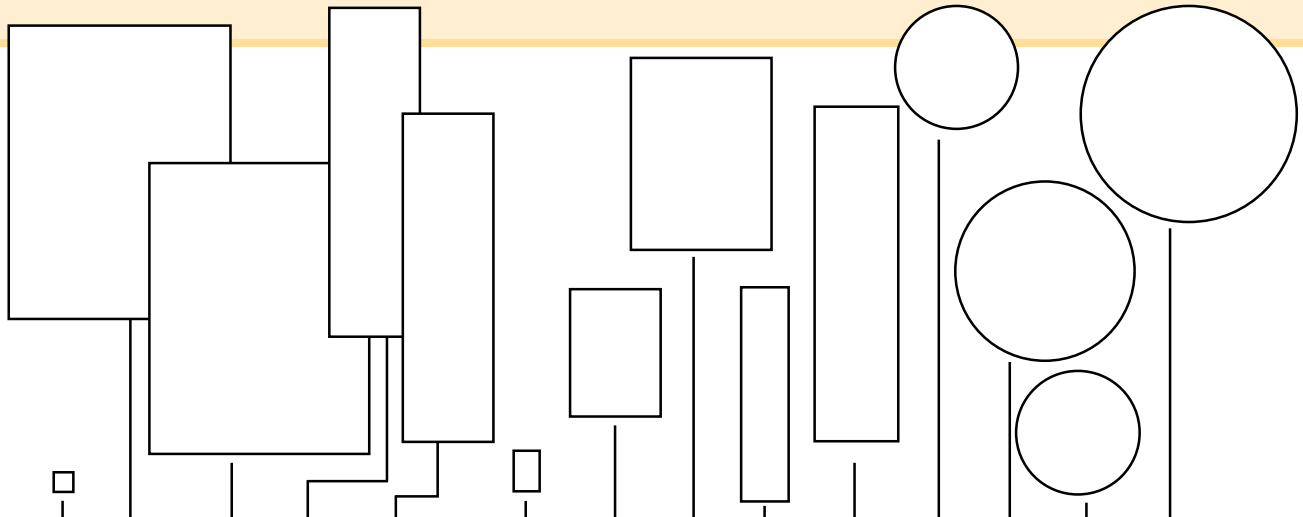

PHOTOFLEX				
Action Dome Dif. *: 17 x 12 cm; Depth **: 17.8 cm	Silver Dome Large Dif. *: 91 x 122 cm; Depth **: 64 cm	White Dome Large Dif. *: 91 x 122 cm; Depth **: 64 cm	Half Dome Silver Dif. *: 38 x 139 cm; Depth **: 61 cm	Half Dome White Dif. *: 38 x 139 cm; Depth **: 61 cm
FV-ENG-KIT1				
	DLSR1	DLSR1		
	RE1	RE1	●	●
	RE1	RE1	●	●
	●	●	●	●
	●	●	●	●
	DLSR1	DLSR1	DLSR1	DLSR1
	AC-GRID L		AC-GRID M	

CHIMERA								
Micro Bank Dif. *: 18 x 13 cm; Depth **: 14 cm	Video Plus Pro XS Dif. *: 40 x 55 cm; Depth **: 30 cm	Video Plus Pro S Dif. *: 60 x 80 cm; Depth **: 46 cm	Video Pro Plus Strip S Dif. *: 20 x 90 cm; Depth **: 40 cm	Video Pro Plus Strip M Dif. *: 35 x 140 cm; Depth **: 56 cm	Standard Lantern 20" Dif. *: Ø 50 cm; Depth **: 44.5 cm	Standard Lantern 30" Dif. *: Ø 76 cm; Depth **: 66 cm	Pancake S Dif. *: Ø 51 cm; Depth **: 24 cm	Pancake M Dif. *: Ø 89 cm; Depth **: 42.5 cm
●								
	RE2	RE2	RE2		RE2	RE2	RE3	RE4
	RE2	RE2	RE2		RE2	RE2	RE3	RE4
		DLSR1 + RE2	DLSR1 + RE1	DLSR1 + RE1				
		RE2	RE1	RE1		RE2		RE4
		RE2	RE1	RE1		RE2		RE4
	[●]	●	●	●	●	●	RE3	RE4
		●	●	●		●	RE3	RE4
		DLSR2	DLSR2	DLSR2				
		DLSR1 + RE2	DLSR1 + RE2			DLSR1 + RE1		DLSR1 + RE4

PHOTOMETRICS

When comparing photometric data of different manufacturers, it should be noted that practically all other lights have a bell shaped light distribution curve (hot spots in the center), while dedolight lighting fixtures show an equal intensity over the entire lit area. Photometric data usually defines intensity at the center of the beam. Other comparable light sources of higher wattages may appear to have a higher output in flood position, yet the dedolights edge to edge output will actually be more. In spot position, the dedolight will easily exceed the center intensity of other lights that have drastically higher wattage ratings.

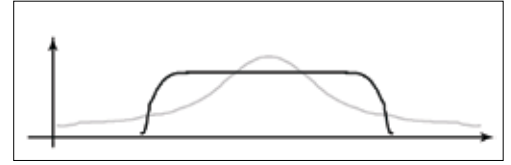

Series 400: DLH400DT, DLH650, DLH436

Distance	Meter	1	2	3	5	10	15	20
	Feet	3.3'	6.6'	9.8'	16.4'	32.8'	49.2'	65.6'

Lamp: 400 W at 575 W Boost (Daylight, 5500 K)										
DLH400DT	Flood 50°	Lit Diameter	Meter	0.93	1.8	2.8	4.7	9.3	14	18.6
			Feet	3'	5.9'	9.2'	13.8'	27.8'	41.7'	61'
		Intensity	Lux	18900	4725	2100	756	189	84	47
			Foot - Candle	1557	439	195	70	18	8	4.4
	Med 13°	Lit Diameter	Meter	0.23	0.46	0.68	1.1	2.3	3.4	4.6
			Feet	0.75'	1.5'	2.2'	3.6'	7.5'	11'	15'
		Intensity	Lux	118000	29502	13112	4720	1180	525	295
			Foot - Candle	10966	2742	1219	439	110	49	27
	Spot 4.5°	Lit Diameter	Meter	0.1	0.17	0.26	0.44	0.87	1.3	1.7
			Feet	0.3'	0.56'	0.9'	1.4'	2.9'	4.3'	5.6'
		Intensity	Lux	371700	92925	41300	14868	3717	1652	929
			Foot - Candle	34545	8636	3838	1382	346	154	86

Lamp: 650 W at 230 V (Tungsten, 3200 K)										
DLH650	Flood 56°	Lit Diameter	Meter	1.1	2.1	3.2	5.3	10.6	16	21
			Feet	3.6'	6.9'	10.5'	17'	34'	52'	68'
		Intensity	Lux	8200	2430	1080	380	95	43	24
			Foot - Candle	762	226	100	35	8.8	4	2.3
	Med 14°	Lit Diameter	Meter	0.25	0.5	0.75	1.2	2.5	3.7	5
			Feet	0.8'	1.6'	2.5'	3.9'	8.2'	12'	16.4'
		Intensity	Lux	21650	5800	2650	950	238	106	59
			Foot - Candle	2012	539	246	88	22	9.8	5.5
	Spot 8°	Lit Diameter	Meter	0.15	0.27	0.42	0.7	1.4	2	2.8
			Feet	0.5'	0.9'	1.4'	2.3'	4.6'	6.5'	9.2'
		Intensity	Lux	96000	25320	13700	4932	1233	548	300
			Foot - Candle	8921	2353	1273	458	115	51	28

Lamp: 400 W at 36 V (Tungsten, 3400 K)										
DLH436	Flood 56°	Lit Diameter	Meter	1.1	2.1	3.2	5.3	10.6	16	21
			Feet	3.6'	6.9'	10.5'	17'	34'	52'	68'
		Intensity	Lux	8524	2172	1010	353	88	40	23
			Foot - Candle	792	202	94	32.8	8.2	3.8	2
	Med 18°	Lit Diameter	Meter	0.32	0.63	0.95	1.6	3.2	4.7	6.3
			Feet	1'	2'	3.1'	5.2'	10.4'	15.4'	20.5'
		Intensity	Lux	40680	10170	4520	1300	356	150	89
			Foot - Candle	3781	945	420	121	33	13	8.3
	Spot 5.5°	Lit Diameter	Meter	0.1	0.2	0.3	0.5	1	1.5	2
			Feet	0.3'	0.66'	1'	1.6'	3.3'	5'	6.6'
		Intensity	Lux	93430	23350	16000	5660	1440	640	360
			Foot - Candle	8683	2170	1486	526	134	59	33

Series 400: Imager Projection Attachment

Distance		Meter	1	2	3	5	7	10
		Feet	3.3'	6.6'	9.8'	16.4'	23'	32.8'
70 mm f/1.6	Diameter round Ø	cm	110	220	330	550	770	1100
		Inch	43"	87"	130"	217"	303"	433"
	Size square	cm	77 x 77	144 x 144	233 x 233	385 x 385	539 x 539	770 x 770
		Inch	30" x 30"	57" x 57"	92" x 92"	152" x 152"	212" x 212"	303" x 303"
	DLH400DT at 575 W	Lux	11844	2961	1316	473	241	119
		Foot - Candle	1100	275	122	44	22	11
	DLH650 – 230 V	Lux	5668	1417	630	226	115	57
		Foot - Candle	527	132	59	21	11	5.3
	DLH436 – 36 V	Lux	4734	1184	526	190	97	47
		Foot - Candle	440	110	49	18	9	4.4
100 mm f/1.6	Diameter round Ø	cm	74	145	220	365	515	730
		Inch	30"	57"	87"	144"	202"	287"
	Size square	cm	50 x 50	100 x 100	154 x 154	255 x 255	360 x 360	510 x 510
		Inch	19" x 19"	39" x 39"	60" x 60"	100" x 100"	140" x 140"	200" x 200"
	DLH400DT at 575 W	Lux	17136	4284	1904	686	350	174
		Foot - Candle	1593	398	176	64	32	15
	DLH650 – 230 V	Lux	8190	2050	910	325	165	82
		Foot - Candle	761	190	85	30	15	7.6
	DLH436 – 36 V	Lux	5580	1700	620	225	114	56
		Foot - Candle	519	158	58	21	10.6	5.2
150 mm f/2.2	Diameter round Ø	cm	51	102	152	255	357	510
		Inch	20"	40"	60"	100"	141"	201"
	Size square	cm	36 x 36	72 x 72	108 x 108	180 x 180	252 x 252	360 x 360
		Inch	14" x 14"	28" x 28"	43" x 43"	71" x 71"	99" x 99"	142" x 142"
	DLH400DT at 575 W	Lux	34020	8505	3780	1361	694	340
		Foot - Candle	3161	790	351	126	64	32
	DLH650 – 230 V	Lux	17253	4313	1917	690	352	173
		Foot - Candle	1603	401	178	64	33	16
	DLH436 – 36 V	Lux	13860	3465	1540	554	284	139
		Foot - Candle	1288	322	143	51	26	13
185 mm f/3.5	Diameter round Ø	cm	38	80	125	200	290	410
		Inch	15"	31"	49"	78"	114"	160"
	Size square	cm	26 x 26	56 x 56	87 x 87	140 x 140	200 x 200	285 x 285
		Inch	10" x 10"	22" x 22"	34" x 34"	55" x 55"	78" x 78"	110" x 110"
	DLH400DT at 575 W	Lux	44100	11200	4900	1764	896	441
		Foot - Candle	4099	1042	455	164	84	41
	DLH650 – 230 V	Lux	28000	6000	2500	900	480	240
		Foot - Candle	2602	558	232	84	45	22
	DLH436 – 36 V	Lux	18000	4500	2000	720	365	180
		Foot - Candle	1673	418	186	67	34	16.7
230 mm f/2.3	Diameter round Ø	cm	31	63	95	158	222	317
		Inch	12"	25"	37"	62"	87"	125"
	Size square	cm	22 x 22	44 x 44	67 x 67	112 x 112	156 x 156	233 x 233
		Inch	9" x 9"	17" x 17"	26" x 26"	44" x 44"	61" x 61"	88" x 88"
	DLH400DT at 575 W	Lux	88200	22050	9800	3528	1800	882
		Foot - Candle	8197	2050	910	328	168	83
	DLH650 – 230 V	Lux	40500	10125	4500	1620	826	405
		Foot - Candle	3763	941	418	151	77	38
	DLH436 – 36 V	Lux	38250	9563	4250	1530	781	383
		Foot - Candle	3555	889	395	142	73	36

Classic Series/Series 200: DLH200DT, DLH4 (100 W), DLH4 (150 W), DLOBA²

Distance	Meter	1	2	3	5	10	15	20
	Feet	3.3'	6.6'	9.8'	16.4'	32.8'	49.2'	65.6'

Lamp: DL200DHR-NB (Daylight, 5500 K)										
DLH200DT	Flood 48°	Lit Diameter	Meter	0.9	1.8	2.7	4.5	9	13	18
			Feet	3'	6'	8.9'	15'	30'	43'	60'
		Intensity	Lux	8505	2126	945	340	86	38	21
			Foot - Candle	790	198	88	32	9	3.5	2
	Med 27°	Lit Diameter	Meter	0.5	0.96	1.4	2.4	4.8	7.2	9.6
			Feet	1.6'	3.2'	4.6'	8'	16'	24'	32'
		Intensity	Lux	36000	9000	4000	1440	360	160	90
			Foot - Candle	3346	836	372	134	33	15	8.4
	Spot 4.5°	Lit Diameter	Meter	0.1	0.16	0.24	0.4	0.8	1.2	1.6
			Feet	0.3'	0.53'	0.8'	1.3'	2.6'	4'	5.3'
		Intensity	Lux	121500	30375	13500	4860	1215	540	304
			Foot - Candle	11292	2823	1255	452	113	50	28

Lamp: 150 W / 24.5 V (DL150) at 24.4 V (Tungsten, 3400 K)										
DLH4 150 W	Flood 48°	Lit Diameter	Meter	0.9	1.8	2.7	4.5	9	13	18
			Feet	3'	6'	8.9'	15'	30'	43'	60'
		Intensity	Lux	4000	1000	445	160	40	18	10
			Foot - Candle	372	93	41	14.9	3.1	1.7	1
	Med 27°	Lit Diameter	Meter	0.5	0.96	1.4	2.4	4.8	7.2	9.6
			Feet	1.6'	3.2'	4.6'	8'	16'	24'	32'
		Intensity	Lux	19800	4950	2200	790	198	88	49
			Foot - Candle	1840	460	204	73	18.4	8.2	4.6
	Spot 4.5°	Lit Diameter	Meter	0.1	0.16	0.24	0.4	0.8	1.2	1.6
			Feet	0.3'	0.53'	0.8'	1.3'	2.6'	4'	5.3'
		Intensity	Lux	81900	20475	9100	3276	819	364	205
			Foot - Candle	7611	1903	846	304	76	34	19

Lamp: 100 W / 12.4 V (DL100) at 12.4 V (Tungsten, 3400 K)										
DLH4 100 W	Flood 48°	Lit Diameter	Meter	0.9	1.8	2.7	4.5	9	13	18
			Feet	3'	6'	8.9'	15'	30'	43'	60'
		Intensity	Lux	2160	540	240	86	21	10	5.4
			Foot - Candle	200	50	22	8	2	1	0.5
	Med 27°	Lit Diameter	Meter	0.5	0.96	1.4	2.4	4.8	7.2	9.6
			Feet	1.6'	3.2'	4.6'	8'	16'	24'	32'
		Intensity	Lux	12960	3240	1440	518	130	58	32
			Foot - Candle	1204	301	134	48	12	5.4	3
	Spot 4.5°	Lit Diameter	Meter	0.1	0.16	0.24	0.4	0.8	1.2	1.6
			Feet	0.3'	0.53'	0.8'	1.3'	2.6'	4'	5.3'
		Intensity	Lux	49500	12375	5500	1980	495	220	124
			Foot - Candle	4600	1150	511	184	46	20.4	11.5

Lamp: 50 W / 12 V (DL50) at 12.4 V (Tungsten, 3400 K)										
DLOBA ²	Flood 70°	Lit Diameter	Meter	1.4	2.8	4.2	7	14	21	28
			Feet	4.6'	9.2'	13.8'	23'	46'	68.9'	91.8'
		Intensity	Lux	624	156	70	25	6.3	3	1.6
			Foot - Candle	58	15	6.5	2.3	0.6	0.3	0.2
	Spot 6°	Lit Diameter	Meter	0.1	0.2	0.3	0.5	1	1.6	2.1
			Feet	0.3'	0.7'	1'	1.7'	3.4'	5.2'	6.9'
		Intensity	Lux	6168	1542	685	244	62	27	15
			Foot - Candle	573	143	64	23	6	2.5	1.4

Classic Series/Series 200: Imager Projection Attachment

Distance	Meter	0,5	1	2	3	4	5	7
	Feet	1.6'	3.3'	6.6'	9.8'	13.1'	16.4'	23'

60 mm f/2.8	Diameter round Ø	cm	40	80	160	240	320	400	560
		Inch	16"	32"	64"	95"	128"	160"	224"
	Size square	cm	25 x 25	50 x 50	100 x 100	150 x 150	200 x 200	250 x 250	350 x 350
		Inch	10" x 10"	20" x 20"	40" x 40"	60" x 60"	80" x 80"	100" x 100"	140" x 140"
	DLH4 100 W at 12.4 V (Tungsten, 3400 K)	Lux	7295	1575	360	155	90	53	29
		Foot - Candle	678	146	33	14.4	8.4	5	2.7
	DLH4 150 W at 24.5 V (Tungsten, 3400 K)	Lux	8646	2830	628	270	150	96	50
		Foot - Candle	803	263	58	25	14	9	4.6
DLH200DT (Daylight, 5400 K)	Lux	17280	4320	1080	480	270	173	88	
	Foot - Candle	1606	402	100	45	25	16	8.2	

85 mm f/2.8	Diameter round Ø	cm	30	60	120	180	240	300	420
		Inch	12"	24"	47"	72"	96"	120"	168"
	Size square	cm	17 x 17	35 x 35	70 x 70	105 x 105	140 x 140	175 x 175	245 x 245
		Inch	6.7" x 6.7"	13" x 13"	27" x 27"	40" x 40"	54" x 54"	67" x 67"	90" x 90"
	DLH4 100 W at 12.4 V (Tungsten, 3400 K)	Lux	9806	3245	638	292	164	99	50
		Foot - Candle	911	301	59	27	15	9.2	4.6
	DLH4 150 W at 24.5 V (Tungsten, 3400 K)	Lux	14575	4867	1089	450	258	157	79
		Foot - Candle	1355	452	101	42	24	14.6	7.3
DLH200DT (Daylight, 5400 K)	Lux	41400	10350	2588	1150	647	414	211	
	Foot - Candle	3848	962	241	107	60	39	20	

185 mm f/3.5	Diameter round Ø	cm	10	20	40	60	80	100	140
		Inch	4"	8"	16"	24"	32"	40"	56"
	Size square	cm	7 x 7	14 x 14	28 x 28	42 x 42	56 x 56	70 x 70	98 x 98
		Inch	2.8" x 2.8"	5.6" x 5.6"	11" x 11"	17" x 17"	22" x 22"	28" x 28"	39" x 39"
	DLH4 100 W at 12.4 V (Tungsten, 3400 K)	Lux	40456	15584	3476	1430	777	472	260
		Foot - Candle	3760	1448	323	133	72	44	24
	DLH4 150 W at 24.5 V (Tungsten, 3400 K)	Lux	61739	29147	6163	2456	1428	807	417
		Foot - Candle	5738	2708	573	228	133	75	39
DLH200DT (Daylight, 5400 K)	Lux	198000	49500	12375	5500	3094	1980	1010	
	Foot - Candle	18401	4600	1150	511	288	184	94	

Conversion factors

To obtain photometric values for light head/bulb or light head/imager combinations that are not listed in the photometric tables, multiply the values from the tables with the conversion factors listed below.

Classic series and series 200

DLH200DT used with a 3200 K ceramic lamp	= 0.95
DLH4 (150 W) switched to 3200 K	= 0.82
DLH4 (100 W) 3400 K tungsten lamp switched to 3200 K	= 0.66
DLH4 used with 50 W / 3400 K tungsten lamp	= 0.70
DLH4 used with 50 W / 3400 K tungsten lamp at 3200 K	= 0.56
DLHM4-300 used with 150 W / 3200 K tungsten lamp	= 0.82

Imager projection attachment for classic series and series 200

DLH4 (100 W) 3400 K tungsten lamp switched to 3200 K	= 0.65
DLH4 (100 W) 3400 K with a 2000 h tungsten lamp	= 0.85
DLH4 (150 W) 3400 K tungsten lamp switched to 3200 K	= 0.80
DLH200DT used with a 3200 K ceramic lamp	= 0.75

Soft lights

DLH200SDT used with a 3200 K ceramic lamp	= 0.95
DLH400SDT run at 400 W	= 0.65

Classic Series/Series 200: Imager Projection Attachment Zooms

Distance	Meter	0.5	1	2	3	4	5	7
	Feet	1.6'	3.3'	6.6'	9.8'	13.1'	16.4'	23'

70-120 mm f/3.5 (at 70 mm)	Diameter round Ø	cm	32.5	5	130	195	260	325	455
		Inch	13"	26"	52"	78"	104"	130"	182"
	Size square	cm	23 x 23	46 x 46	92 x 92	138 x 138	184 x 184	230 x 230	322 x 322
		Inch	9" x 9"	18" x 18"	36" x 36"	54" x 54"	72" x 72"	90" x 90"	126" x 126"
	DLH4 100 W at 12.4 V (Tungsten, 3400 K)	Lux	9875	3292	780	364	198	130	62
		Foot - Candle	918	306	73	34	18	12	5.8
	DLH4 150 W at 24.5 V (Tungsten, 3400 K)	Lux	17820	4455	1114	496	279	178	90
		Foot - Candle	1656	414	104	46	26	17	8.4
	DLH200DT (Daylight, 5400 K)	Lux	25740	6435	1609	715	402	257	131
		Foot - Candle	2392	617	150	67	37	24	12

70-120 mm f/3.5 (at 120 mm)	Diameter round Ø	cm	19.5	39	78	117	156	195	273
		Inch	7.7"	15"	30"	45"	60"	75"	105"
	Size square	cm	14 x 14	28 x 28	55 x 55	83 x 83	110 x 110	138 x 138	193 x 193
		Inch	5.5" x 5.5"	11" x 11"	22" x 22"	33" x 33"	44" x 44"	55" x 55"	66" x 66"
	DLH4 100 W at 12.4 V (Tungsten, 3400 K)	Lux	26166	6542	1920	718	476	260	125
		Foot - Candle	2432	607	178	67	44	24	38149
	DLH4 150 W at 24.5 V (Tungsten, 3400 K)	Lux	46440	11610	2904	1290	726	464	237
		Foot - Candle	4316	1079	270	120	67	43	22
	DLH200DT (Daylight, 5400 K)	Lux	69120	17280	4320	1920	1080	691	353
		Foot - Candle	6424	1606	402	178	100	64	33

85-150 mm f/3.5 (at 85 mm)	Diameter round Ø	cm	30	60	120	180	240	300	420
		Inch	12"	24"	47"	71"	94"	118"	165"
	Size square	cm	21 x 21	42 x 42	85 x 85	127 x 127	170 x 170	212 x 212	297 x 297
		Inch	8.3" x 8.3"	17" x 17"	33" x 33"	50" x 50"	67" x 67"	83" x 83"	117" x 117"
	DLH4 100 W at 12.4 V (Tungsten, 3400 K)	Lux	11160	2790	698	310	174	112	57
		Foot - Candle	1037	259	65	29	16	10	38051
	DLH4 150 W at 24.5 V (Tungsten, 3400 K)	Lux	16668	4167	1042	463	260	167	85
		Foot - Candle	1549	387	98	43	24	16	8
	DLH200DT (Daylight, 5400 K)	Lux	36000	9000	2250	1000	563	360	184
		Foot - Candle	3346	836	209	93	52	34	17

85-150 mm f/3.5 (at 150 mm)	Diameter round Ø	cm	17.5	35	70	105	140	175	245
		Inch	7"	14"	28"	41"	55"	69"	97"
	Size square	cm	12.3 x 12.3	25 x 25	50 x 50	74 x 74	99 x 99	124 x 124	173 x 173
		Inch	4.8" x 4.8"	9.8" x 9.8"	20" x 20"	29" x 29"	39" x 39"	49" x 49"	68" x 68"
	DLH4 100 W at 12.4 V (Tungsten, 3400 K)	Lux	27144	6786	1697	754	424	271	138
		Foot - Candle	2523	631	158	70	39	25	13
	DLH4 150 W at 24.5 V (Tungsten, 3400 K)	Lux	47880	11970	2993	1330	748	479	244
		Foot - Candle	4450	1113	278	124	70	45	23
	DLH200DT (Daylight, 5400 K)	Lux	99000	24750	6188	2750	1547	990	505
		Foot - Candle	9201	2300	575	256	144	92	47

dedocool

The special qualities of extreme intensity and low heat are mainly effective at short distances.

Distance	cm	20	30	40	50
	Inch	7.9"	11.8"	15.8"	19.7"

Lamp: 250 W / 24 V					
Lit Diameter	cm	6	7	9	12
	Inch	2.36"	2.76"	3.54"	4.72"
Intensity	Lux	2,390,000	1,130,000	580,000	370,000
	Foot - Candle	222,031	104,997	53,882	34,737
Temp	°C	59	42	35	31
	°F	138.2	107.6	95	87.8

Series 400: dedoPAR

Three different spread lenses can be used to widen the beam angle.

Distance	Meter	1	2	3	5	10	15	20
	Feet	3.3'	6.6'	9.8'	16.4'	32.8'	49.2'	65.6'

Lamp: 575 W (Daylight, 5500 K)										
dedoPAR	Without lens	Intensity	Lux	1505000	376250	167222	60200	15050	6688	3762
			Foot - Candle	139870	34966	15540	5594	1399	620	350
	Spread lens 1	Intensity	Lux	752500	188125	83611	30100	7525	3345	1882
			Foot - Candle	69934	17483	7770	2793	700	311	175
	Spread lens 2	Intensity	Lux	89250	22313	9916	3570	893	396	223
			Foot - Candle	8295	2073	921	332	83	36	21
	Spread lens 3	Intensity	Lux	36400	9100	4045	1456	364	162	91
			Foot - Candle	3382	846	375	136	34	15	8

Soft lights: DLH1x150S, DLH1x300S, DLH4x150S, DLH1000S, DLH1000SPPLUS, DLH200SDT, DLH400SDT

Distance	Meter	3
	Feet	9.8'

Distance	Meter	3
	Feet	9.8'

DLH1x150S	Lamp: 150 W / 24 V at 24.4 V (Tungsten, 3400 K)		
	Silver Dome, small	Lux	78
		Foot - Candle	7.2
	Silver Dome, medium	Lux	81
Foot - Candle		7.5	

DLH200SDT	Lamp: 200 W (Daylight, 5500 K)		
	Silver Dome, small	Lux	245
		Foot - Candle	23
	Silver Dome, medium	Lux	191
Foot - Candle		18	

DLH1x300S	Lamp: 300 W / 230 V at 230 V (Tungsten, 3200 K)		
	Silver Dome, small	Lux	70
		Foot - Candle	6,5
	Silver Dome, medium	Lux	73
Foot - Candle		6,7	

DLH400SDT	Lamp: 400 W at 575 W (Daylight, 5500 K)		
	Silver Dome, medium	Lux	645
		Foot - Candle	60
	Silver Dome, large	Lux	724
		Foot - Candle	67
	PanAura®/Octodome 5	Lux	810
Foot - Candle		75	

DLH4x150S	Lamp: 150 W / 24 V at 24.4 V (Tungsten, 3200 K)		
	Silver Dome, small	Lux	310
		Foot - Candle	29
	Silver Dome, medium	Lux	290
		Foot - Candle	27
	Silver Dome, large	Lux	255
		Foot - Candle	23
	PanAura®/Octodome 5	Lux	310
Foot - Candle		29	

DLH1000S DLH1000SPPLUS	Lamp: 1000 W / 230 V (Tungsten, 3200 K)		
	Silver Dome, medium	Lux	225
		Foot - Candle	21
	Silver Dome, large	Lux	220
		Foot - Candle	20
	PanAura®/Octodome 5	Lux	340
Foot - Candle		32	

DEDOLIGHT PRODUCT CODE INDEX

36DL400LL	61	DH2	53	DP1	49	DSBSS	21
ADAPTER	54	DHF	49	DP10	49	DSBSXS	21
ADAPTER423	43	DIMTA3	40	DP2	51	DSBWM	21
BASEH	54	DL20	44	DP20	51	DSBWS	21
BASEL	54	DL50	44	DP3	51	DSC1	58
BIGPACK1	32, 42	DL100	44	DP30	51	DSC1-200	59
CLAMP1	53	DL100-24	44	DP400	28	DSC150S	59
CLAMP-C	54	DL150	44	DP400-70	29	DSC2	58
CLAMP-D	54	DL200DHR-NB	31	DP400-100	29	DSC2-200	59
COOLAMP	67	DL200THR-NB	31	DP400-150	29	DSC300S	59
COOLH	55	DL300FSL-NB	37	DP400-185	29	DSC400	59
COOLSET	67	DL400DHR-NB	18, 19	DP400-230	29	DSCD	45
COOLT3	55	DL500EHC-NB	21	DP4002GR	29	DSCD400	26
DBD2	45	DL600GKV-NB	21	DP4002GR+	29	DSCFD	45
DBD400	26	DL650FRM-NB	21	DP400CON	28	DSCFD400	26
DBD8	45	DL650FRK-NB	21	DP400FH	29	DSCFS	45
DCAR3	39	DL650T26-NB	61	DP400FS	29	DSCFS400	26
DCBAT	56	DL750EHF-NB	21	DP400FSF	29	DSCG	45
DCDP400	58	DL750EHG-NB	21	DP400G	29	DSCG400	26
DCF	47	DL800HX-NB	79	DP400GC	29	DSCGP	45
DCHD	56	DL1000FEL-NB	21	DP400GG	29	DSCGP400	26
DCHD200-1	57	DL1000FEP-NB	21	DP400GGH	29	DSCK	45
DCHD200-3	57	DLBAT84-2	41	DP400GH	29	DSCK400	26
DCHD3x4	57	DLBAT84-13	41	DP400IR	29	DSCM	59
DCHD3x6	57	DLBOX	71	DP400KFS	28	DSCPA5 (DSCOCT)	59
DCHD400	57	DLCLAMP	53	DP400KU	28	DSCP	45
DCHDCOOL	67	DLGRIDM	21	DP400LFS	28, 29	DSCP400	26
DCHDKA1	56	DLPA5G	19, 21	DP400LH	29	DSCS1/2	45
DCHDM4	56	(DLGRIDOCT)		DP400SH	29	DSCS1/2-400	26
DCHDX	56	DLPA3G	19, 21	DP400SHA	29	DSCST	59
DCPAR	58	(DLGRIDOCTS)		DP400U	28	DSCXLV	59
DDCF	47	DLGRIDS	21	DPACP	45	SPA5DT-B (DSOCTD)	65
DDCF400	26	DLGRIDXS	21	DPACP400	26, 29	SPA5DTT (DSOCTDT)	65
DEB200DT-BAT	32	DLH1000S	20, 21	DPAR-O	23	SPA5T-B (DSOCTT)	65
DEB200DT-BATAB	32	DLH1000SPPLUS	20, 21	DPARBD	23	DST	53
DEB200DT-BATPAG	32	DLH1x150S	35	DPARD1/2/3	23	DST400	26
DEB200DT	32	DLH1x300S	37	DPAR-S	23	DST400S	26
DEB200H	32	DLH1x300SDIM	37	DPEYEP	52	DSTFX	53
DEB400DT	18	DLH200DT	31	DPEYASET	29, 52	DSTX	53
DEB400H	26	DLH200SDT	31	DPFS	49	DT12-4	38
DEDOPAR	22	DLH4	34	DPG	50	DT12DC	43
DEXTCHG	32, 42	DLH400DT	18	DPGC	50	DT24-1	40
DFCOL2	47	DLH400SDT	19	DPGG	50	DT24-3	39
DFGW30	47	DLH436	25	DPGGC	50	DT36-1	25
DFH	45	DLH4x150S	36	DPGGH	49	DT4x150	36
DFH400	26	DLH650	24	DPGH	49	DTCF	47
DFSW30	47	DLH650PO	24	DPGSET	50	DTCF400	26
DFT30	47	DLHAND	54	DPGSET400	50	DTS	54
DG1105	54	DLHM4-300	34	DPIR	49	DV6B	53
DGB	46	DLHM4-300DMX	34	DPL60M	48	DVVS	53
DGB8	46	DLHM4-300SE	34	DPL85M	48	DXBAT4-3	39
DGCOL	46	DLOBA ²	43	DPL185M	48	HTP150S	37
DGCOL8	46	DLOBA ² -AB	43	DPLS	45	HTP200S	37
DGMB	46	DLOBA ² -PAG	43	DPLS400	26	HTP300S	37
DGMB8	46	DLOBA ² -XLR	43	DPLZ120M	48	HTP400S	37
DGMD	46	DLSA	53	DPLZ150M	48	HTP4x150S	37
DGMD8	46	DLSPLIT	42	DPOW200DT	70	HTP1000S	37
DGND	46	DLSR1	88	DPOW3	39	K12B	72
DGND8	46	DLSR2	88	DPOW4X	37	K12M	72, 78
DGRADF03	45	DLSR70	21, 88	DPOW400DT	23	K12S	72
DGRADF06	45	DLSR8	88	DPOW436	61	K200-1	69
DGRADF09	45	DLSWI1000	26	DPSH	49	K200-3	69
DGRADF400-03	26	DLSWI300	32	DPX	48	K24B	73
DGRADF400-06	26	DLTFH	47	DLPA5 (DSBOCT)	19, 21	K24M	73
DGRADF400-09	26	DLUMT	53	DLPA3 (DSBOCTS)	19, 21	K24S	73
DGW	46	DLWA	45	DSBSM	21	K3x400DTB	64

K3x400DT-S	64	S1M	82
K3x650-B	63	S1S	82
K3x650-S	63	S200-2	70
K400DT-B	62	S200-2M	70
K400DT-S	62	S200-3	70
K436	63	S2B	83
KA1B	75	S2M	83
KA1M	75	S2S	83
KA1S	75	S3B	84
KA24-4B	77	S3M	84
KA24-4M	77	S3S	84
KA24B	76	S4	85
KA24M	76	S400DT	62
KA24S	76	S5B	86
KAC24B	74	S5M	86
KAC24M	74	SBABE-B	81
KAC24S	74	SBABE-S	81
KBAT84-13	87	SJUN-B	81
KBAT84-2	87	SJUN-S	81
KDP400KFS	66	SM12	80
KDP400KU	66	SM24-1	80
KOB84-13	87	SM24-300	80
KOB84-2	87	SM24P	81
KPAR	67	SSEN-B	81
KPAR-1	67	SSEN-S	81
KX	78	STUD6L	54
MG1106	54	STUD6M	54
NF1105	54	STUD6S	54
RE1	88, 89	STUDL	54
RE2	88, 89	STUDL90	54
RE3	88, 89	STUDS	54
RE4	88, 89	STUDV	54
S1B	82	SUPERMAX	78

We thank all of the creative professionals who push dedolight technology to the limit every day on locations around the world. Without their support and encouragement we wouldn't be here today.

We accept their challenges in designing and producing the finest precision lighting instruments in the world.

dedolight

.... dedicated to the art of lighting.



Photo credits:

Marek Czarnecki

Front page title
Page 9, left column
Page 17

Michel Escourbiac
Ahmed Ertug

Page 27, top
Page 8, bottom, right
Page 9, right column
Spiritual Journey: Sacred Art from the Musée Guimet
www.ertug-kocabiyik.com

Chris Parks

Page 8, Peter Park's portrait
www.imagequestmarine.com
Page 10, right column, bottom
www.imagequestmarine.com

Peter Parks

Page 10, left column
Page 10, top right column
Page 27, bottom
Page 29

Taly Noy
Angel Penchev
Alex Bercovitch
Marco Erdmann

All other photographs by Davor Marinkovic and the team of interns at Dedo Weigert Film GmbH.

Text/Layout:

Dedo Weigert, Katja Roske

Realization/Production:

Katja Roske, Michael Bauer



DEDICATED TO
THE ART OF LIGHTING

PRECISION LIGHTING INSTRUMENTS

Dedo Weigert Film GmbH
Phone: +49 (0)89 356 16 01
Fax: +49 (0)89 356 60 86
Karl-Weinmair-Straße 10
80807 Munich
www.dedoweigertfilm.de
E-mail: info@dedoweigertfilm.de

DEDOTEC USA, INC.
Phone: +1 (413) 229 - 2550
Fax: +1 (413) 229 - 2556
48 Sheffield Business Park
Ashley Falls, MA 01222
www.dedolight.com
E-mail: info@dedolight.com

