



EstesRockets.com

UNIVERSAL ASTROCAM[®]

HD ROCKET CAMERA & HOLDER

2208



CAUTION:

Not intended for use with rockets that are smaller than a BT50 (0/98 in./25 mm) diameter body tube.

CAMERA & HOLDER ATTACHMENT INSTRUCTIONS

KEEP FOR FUTURE REFERENCE. READ ALL INSTRUCTIONS CAREFULLY.

IMPORTANT: Please record date found on package and keep for future reference _____

PARTS

073249
Camera Holder

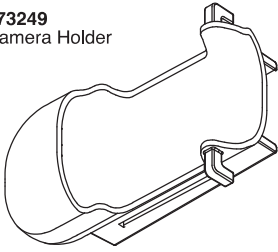

073217
HD Camera

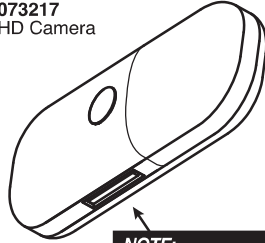

NOTE:
Memory card in camera.

073248
Reusable
Attachment
Straps
X3

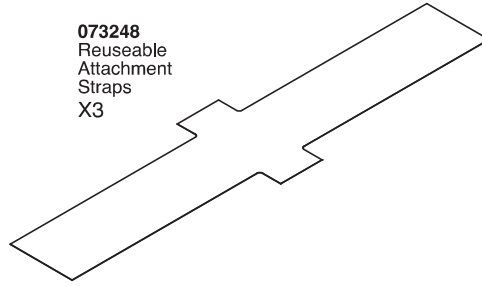

067112
Rubber Bands
X6



INSERT PAPER STRAP THROUGH BACK OF CAMERA HOLDER

1.

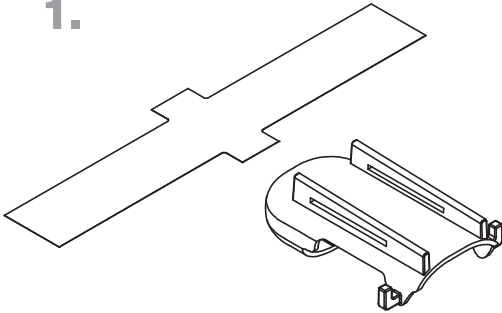

2.

Starting from the middle, insert one end of strap. Form a "U" Shape and repeat for other side.

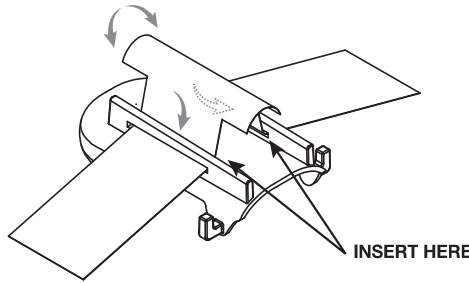

3.

Pull tight.

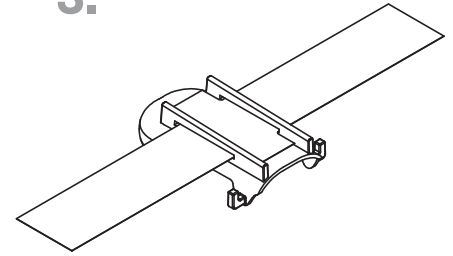

SECURE CAMERA HOLDER TO ROCKET BODY TUBE

1.

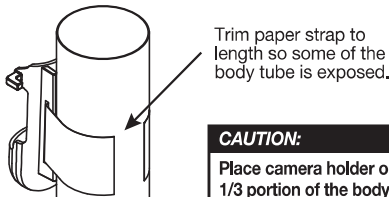

Trim paper strap to length so some of the body tube is exposed.

CAUTION:
Place camera holder on the upper 1/3 portion of the body tube.

NOTE:
Camera and Launch Lug(s) must be opposite of each other.

2.

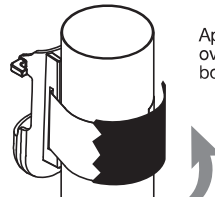

Apply "electrical tape" over paper strap and body tube.

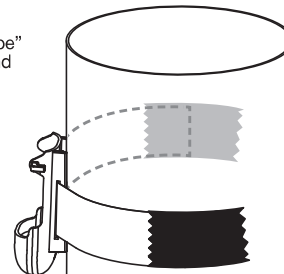

For large body tubes, use 2 pieces of "electrical tape" to secure strap to body tube.

NOTE:
Use new tape when moving camera holder to a different rocket.

INSERT CAMERA

1.

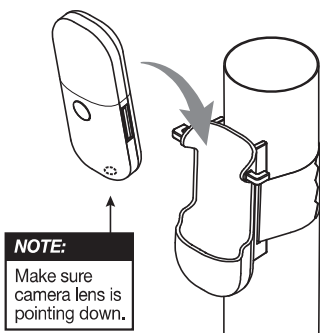

NOTE:
Make sure camera lens is pointing down.

2.

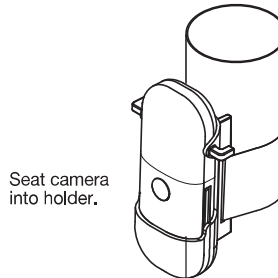

Seat camera into holder.

3.

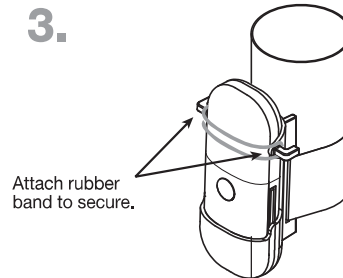

Attach rubber band to secure.

CAMERA DETAILS

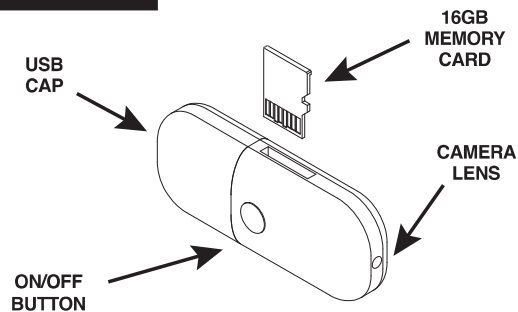

Video Format: .AVI
Video Resolution: 1920 x 1080, 16:9
Picture Format: .JPG
Picture Resolution: 2560 x 1440
Frame Rate: 30 fps
Battery Charge Life: 40 minutes
USB 2.0

The 16GB memory card will provide approximately 90 minutes of recording time. The Astrocam® can support 1 memory card up to 128GB.

BATTERY CHARGING

Charge before first use. Insert USB connector into port in computer or other 5V USB charger port. Blue LED slowly blinks. Charging time is two to three hours.

VIDEO CAMERA USAGE

- 1. To Turn Camera On:** Press ON/OFF button for two seconds. Blue LED light will stay on.
- 2. To Begin Filming:** Press ON/OFF button. Blue LED light begins blinking.
- 3. To Stop Recording:** Press ON/OFF button. Blue LED light stays on.
- 4. To Turn Camera Off:** Press ON/OFF button for two seconds. Blue LED will blink slowly 3 times and power off.

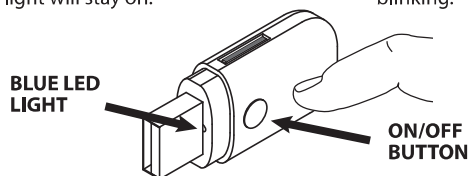

STILL PICTURE USAGE

- To Turn Camera On:** Press ON/OFF button for two seconds. Blue LED light will stay on.
- Press ON/OFF button quickly two times. Blue LED will blink indicating a photo has been taken.

LED LIGHT INDICATOR

No Memory Card: Light shuts off after blinking three times.

Standby: Light stays on.

Memory Card Full: Light shuts off after blinking six times.

Low Battery: Light will turn off after one half second. After two attempts to turn on camera, light will turn off and stay off.

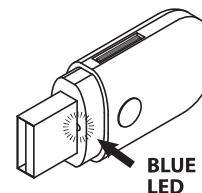

Charge Battery: Light blinks slowly. When fully charged, light remains on.

Video Recording: Light blinks.

SET DATE & TIME

When new from factory or when using a brand new memory card, start by doing the following. Press ON/OFF button for two seconds. Blue LED light will stay on. Press ON/OFF button for two seconds to turn camera off. This procedure will create the files needed on the memory card for the next step. Insert USB connector into USB port on computer. Select the drive letter that corresponds to the removable storage device. Open the time text document (time.txt). Change the date and time numbers to your current date and time. You must use the same format as displayed year/month/day. Click on "File", click "Save", click "File", then click "Exit". Remove camera from USB port. Turn on camera, turn off camera. Your videos should now display the correct date and time.

REMOVING/INSERTING MEMORY CARD

The memory card comes installed in the camera. To eject the memory card, use a paper clip or pen. Gently press down until you feel a click and the memory card will pop out. To reinstall, use paper clip or pen and gently push into slot.

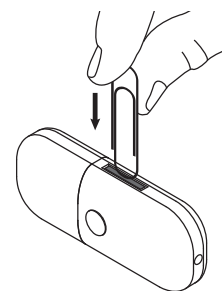

VIEWING RECORDED VIDEO

Remove cap from the camera body housing. Insert USB connector into computer port.

For optimal viewing performance transfer .AVI file to your local computer's hard disk drive and open in Windows Media Player.

Additional software may be required.

For assistance please call (719) 372-6565 ext. 216 for Customer Service
Mon - Fri, 7:30AM - 3:30PM

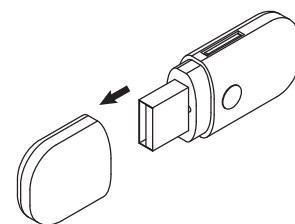

This device complies with part 15 of the FCC Rules. Operation is subject to the following two conditions: (1) This device may not cause harmful interference, and (2) This device must accept any interference received, including interference that may cause undesired operation.

Note: This equipment has been tested and found to comply with the limits for a Class B digital device, pursuant to part 15 of the FCC Rules. These limits are designed to provide reasonable protection against harmful interference in a residential installation. This equipment generates, uses and can radiate radio frequency energy and, if not installed and used in accordance with the instructions, may cause harmful interference to radio communications. However, there is no guarantee that interference will not occur in a particular installation. If this equipment does cause harmful interference to radio or television reception, which can be determined by turning the equipment off and on, the user is encouraged to try to correct the interference by one or more of the following measures:

- Reorient or relocate the receiving antenna.
- Increase the separation between the equipment and receiver.
- Connect the equipment into an outlet on a circuit different from that to which the receiver is connected.
- Consult the dealer or an experienced radio/TV technician for help.

Caution: Changes or modifications not expressly approved by the party responsible for compliance could void the user's authority to operate the equipment.

