

Step 9 : Strap up the triangular net guides(L) on either side of the net at the top. Secure them with hook & loop attachments. These are useful for practising certain spin shots in that they prevent the balls from spinning off the nets.

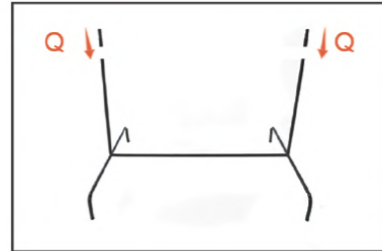

Step 10 (optional) : To extend height by 6 inches, use the height extensions (Q) with vertical poles (C) in Step 2.



NOW YOU'RE READY FOR RACKET SPORTS ACTION !



Disassembly: For disassembling the racket sports rebounder, please perform the above steps in reverse order – step 9 to step 1.

For video assembly instructions –

- Please visit <https://www.kathysuniverse.com/pages/rebounder>
- Or scan the QR code on this page.



Returns and refunds

If you have any questions or concerns about returns or refunds, we recommend reaching out directly to your seller for assistance.

Technical difficulties and purchasing spare parts

For assistance with technical difficulties and spare parts inquiries, please contact us at customerservice@kathysuniverse.com We aim to respond you within 12 hours.



Rebounder Net Blue Large

Model No.: GS8001



CAUTIONS:

- Please use adult supervision & strictly follow these instructions during set up & use.
- Ensure there is no obstruction & do not stand behind the net when others are using it.
- Treat this product with care and it will serve you well.
- Carefully check the net & frame before each use.
- During use, please position yourself in the center & directly in front of the net.
- Exercise usual sports safety precautions as failure to do so may result in injury or damage to property.

Parts List



- A. Base legs x 2
- B. Lower horizontal bar x 1
- C. Vertical poles x 2
- D. Lower diagonal bars x 2
- E. Upper diagonal bars x 2
- F. Corner units x 2
- G. Upper horizontal bar x 1(rolled up in net)
- H. Swivel board x 1
- J. Knobs & washers x 2
- K. Net (55.9in x 117.3in) x 1
- L. Net guides x 2
- M. Bungee loops x 10; plus spares x 4
- N. Carry bag
- P. Instruction manual
- Q. Height extensions x 2

Assembly Instruction

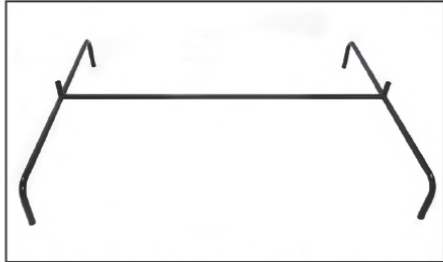

Step 1 : Connect both base legs (A) by inserting the ends of the lower horizontal bar (B) into the horizontal outlets of base legs (A) until the locking pins engage in place.

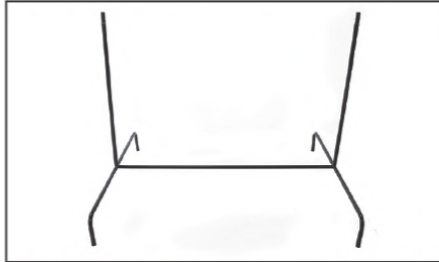

Step 2 : Connect the vertical poles (C) by inserting them into the vertical outlets of the base legs (A).

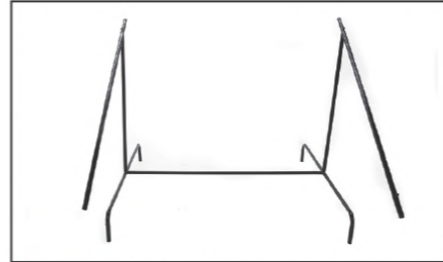

Step 3 : Attach the lower diagonal bars (D) by inserting the vertical poles (C) into the vertical connection outlets of the lower diagonal bars (D).

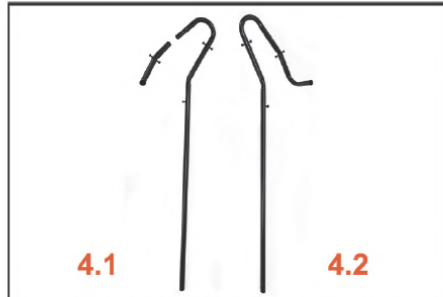

Step 4 : Connect the upper corner units (F) by inserting the appropriate ends into the connection outlets of the upper diagonal bars (E).

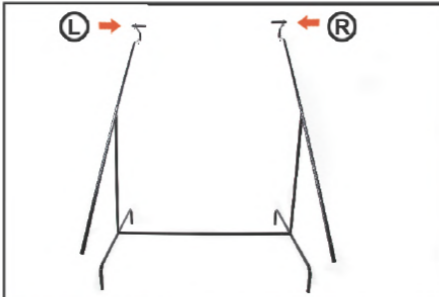

Step 5 : Attach the upper diagonal bars with corner units (E+F) by inserting them into the connection outlets of the lower diagonal bars (D).

** Please note the left corner unit is labelled **L** and the right corner unit is labelled **R**.*

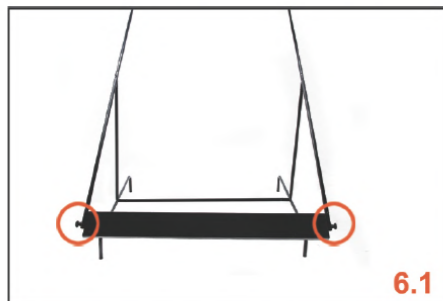

Step 7 : Prepare the Net

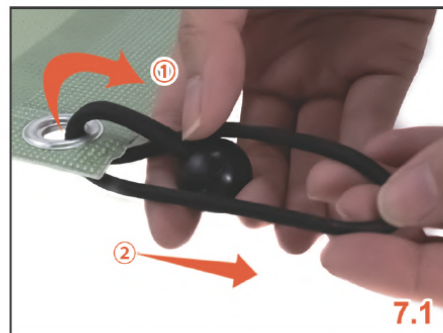

7.1 : Tie up all the 10 bungee (M) loop net fasteners, one to each of the 10 holes of the net (there should be 4 spare bungee loops).

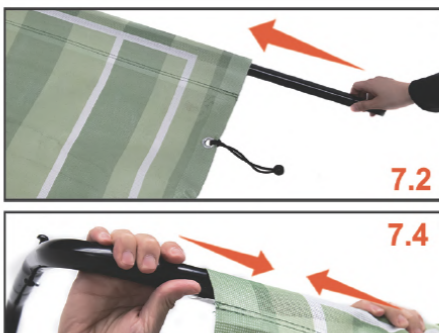

7.2-7.5 : Insert the upper horizontal bar through the top of the net (K) if necessary and connect it to each end of the corner units (F).

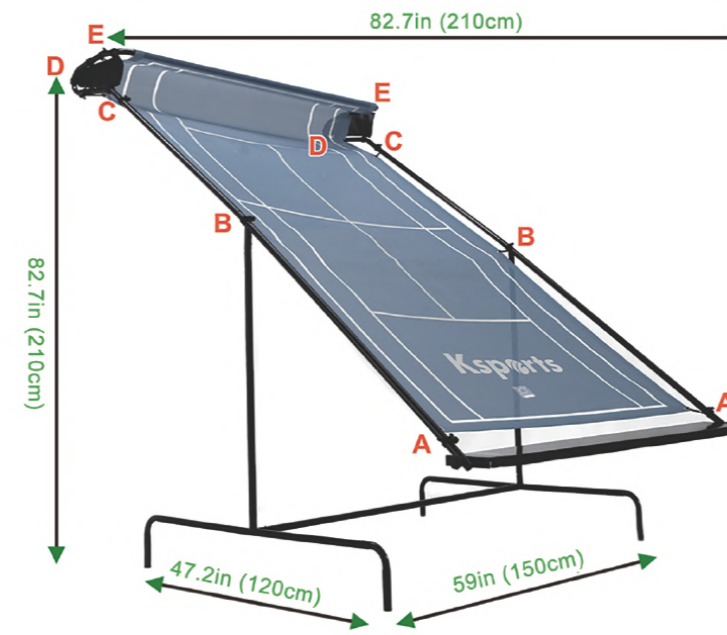

Step 8 : Strap up the net between the holes and anchor points along the frame using the bungee loops as shown in the pictures here – positions A, B, C, D & E. The Bungee loops should be strapped around the bars to obtain the correct tension on the net.



Default strappings for general use :

A, B, C, D & E: All 5 bungee loop positions should be strapped under the bars as shown in the pictures 8.1 - 8.3.



Strappings for different racket sports for more advanced users :

For more advanced users, strap bungee loops under the bar for positions A & B. The 2 bungee loops of positions C & D can be tied either above or below the bars to achieve the correct timing between shots for each racket sports practice. Please refer to the table here for different racket sports & pictures of strappings over the bar 8.4 - 8.6.

For tennis it is best to strap positions B & E as loose as possible 8.7-8.8. Insert the anchor nail through the loop between the round adjuster and the end of the cord.

Strapping Positions for different racket sports (either above or below the bar)

Position	Tennis	Pickleball	Padel	Squash	Racquetball	Table Tennis
C	Above	Above	Above	Below	Below	Below
D	Below	Below	Below	Above	Above	Above