



**2019+ Hyundai Veloster Turbo BIG MOUTH
LIT KIT Ram Air Intake Installation Guide**

VELOSSA TECH

Kit Contents

Please review this document before attempting installation.

You will need basic hand tools and about 2 hours of installation time.

Please review the table below and make sure you have received the kit contents.

Kit Contents	Qty
Diode Dynamics RGBW Controller	1
Positive Cable w/ In-Line Fuse	1
Power Cable w/ Pigtail Connector	1
Switch	1
Switch Ground Cable w/ Pigtail Connector	1
8" Zip Ties	5
M6 x 12mm Cap Screw	1
M6 Lock Nut	1
Assembled LIT KIT BIG MOUTH	1



Kit Contents (LIT Flare Only)

Please review the table below and make sure you have received the kit contents.

Kit Contents	Qty
Diode Dynamics RGBW Controller	1
Positive Cable w/ In-Line Fuse	1
Power Cable w/ Pigtail Connector	1
Switch	1
Switch Ground Cable w/ Pigtail Connector	1
8" Zip Ties	5
Cable Clips	2
M6 x 12mm Cap Screw	1
M6 Lock Nut	1
Assembled LIT Flare	1



If you already own the Velossa Tech GEN 4 Veloster Turbo BIG MOUTH, skip to slide 7 to see install and wiring instructions.



Bumper Removal

REMOVE BUMPER PRIOR TO ATTEMPTING INSTALLATION.

Use YouTube as a resource, there are many bumper removal videos to guide you.

Stock Components Removal

Once the bumper is removed, you will need to remove the OEM air shield shown below.

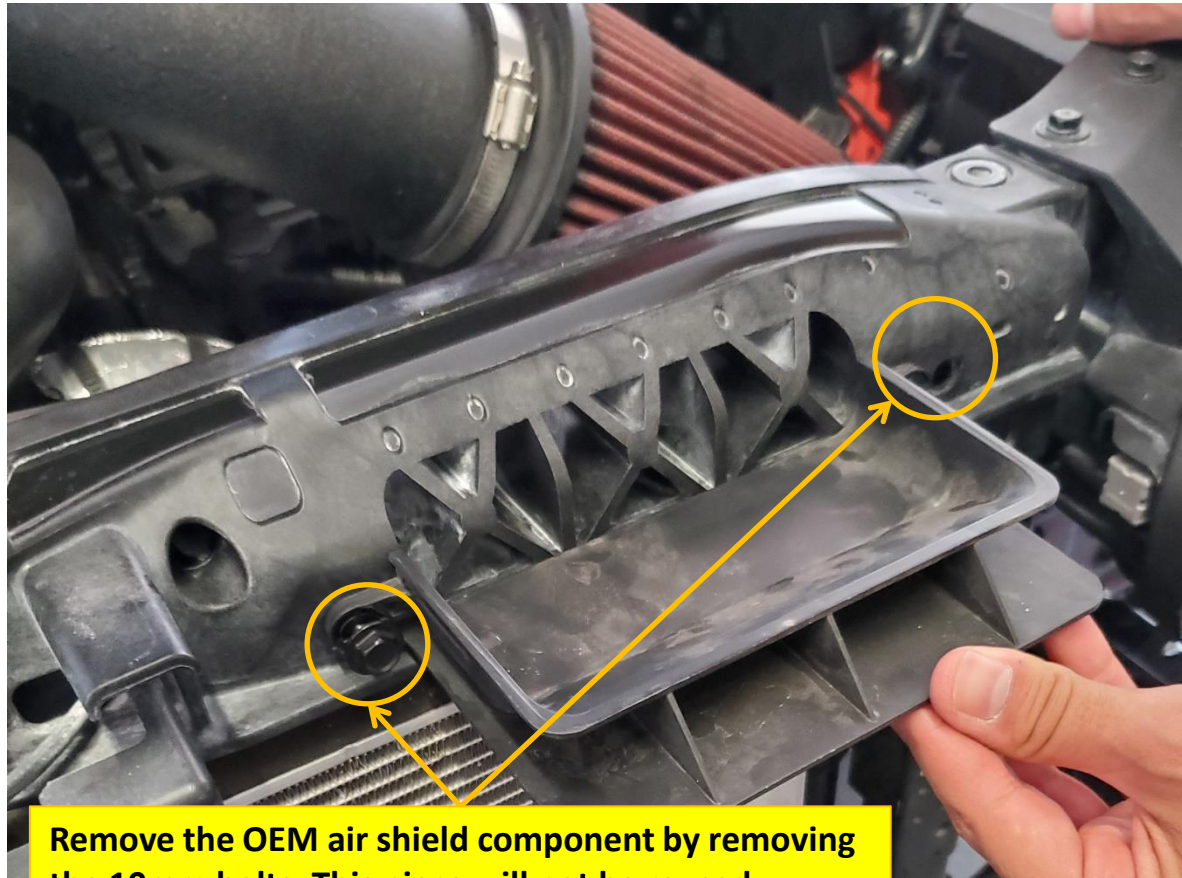

Remove the OEM air shield component by removing the 10mm bolts. This piece will not be reused.

Stock Component Removal

Remove the screws (10 mm) and pop-up clip placed in the locations indicated below. To remove the wire loom fastener, pinch it from the back and pull forward. Remove the radiator shroud.



Install the LIT BIG MOUTH Flare

SKIP THIS SLIDE IF YOU PURCHASED A FULL LIT KIT

Attach the supplied cable clip to your BIG MOUTH as shown. Fasten the cable and provide enough slack to not strain the cable.

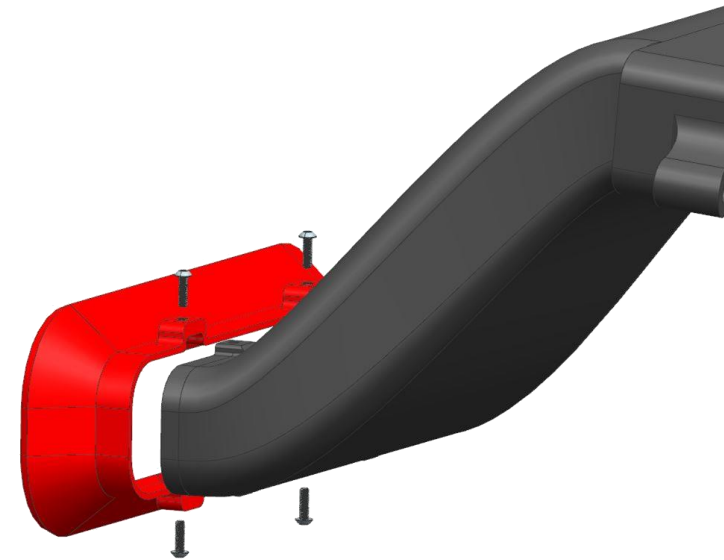

If you purchased a LIT flare-only and already have a Gen 4 BIG MOUTH. Remove old flare and install the LIT flare with the 4 screws as shown.

BIG MOUTH Installation Procedure

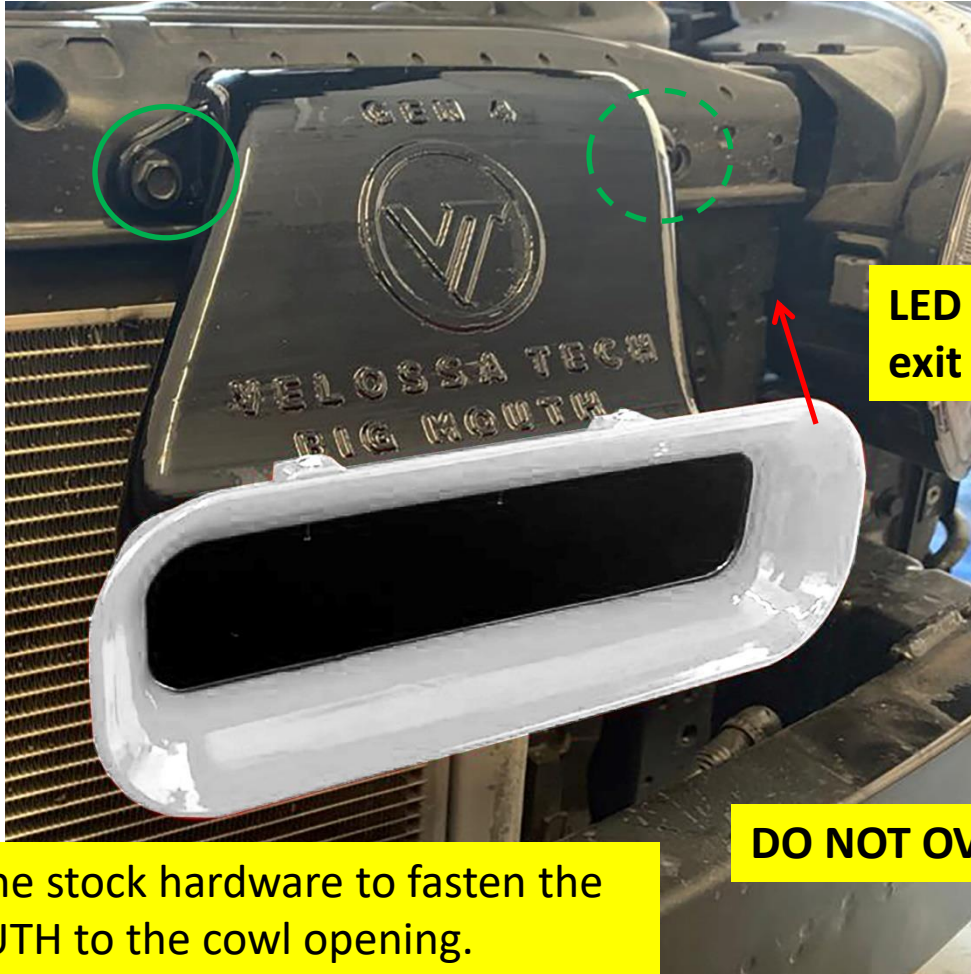

LED power wires
exit this side

DO NOT OVERTORQUE OR CROSS THREAD.

Re-use the stock hardware to fasten the
BIG MOUTH to the cowl opening.



VELOSSA TECH

Wiring Harness

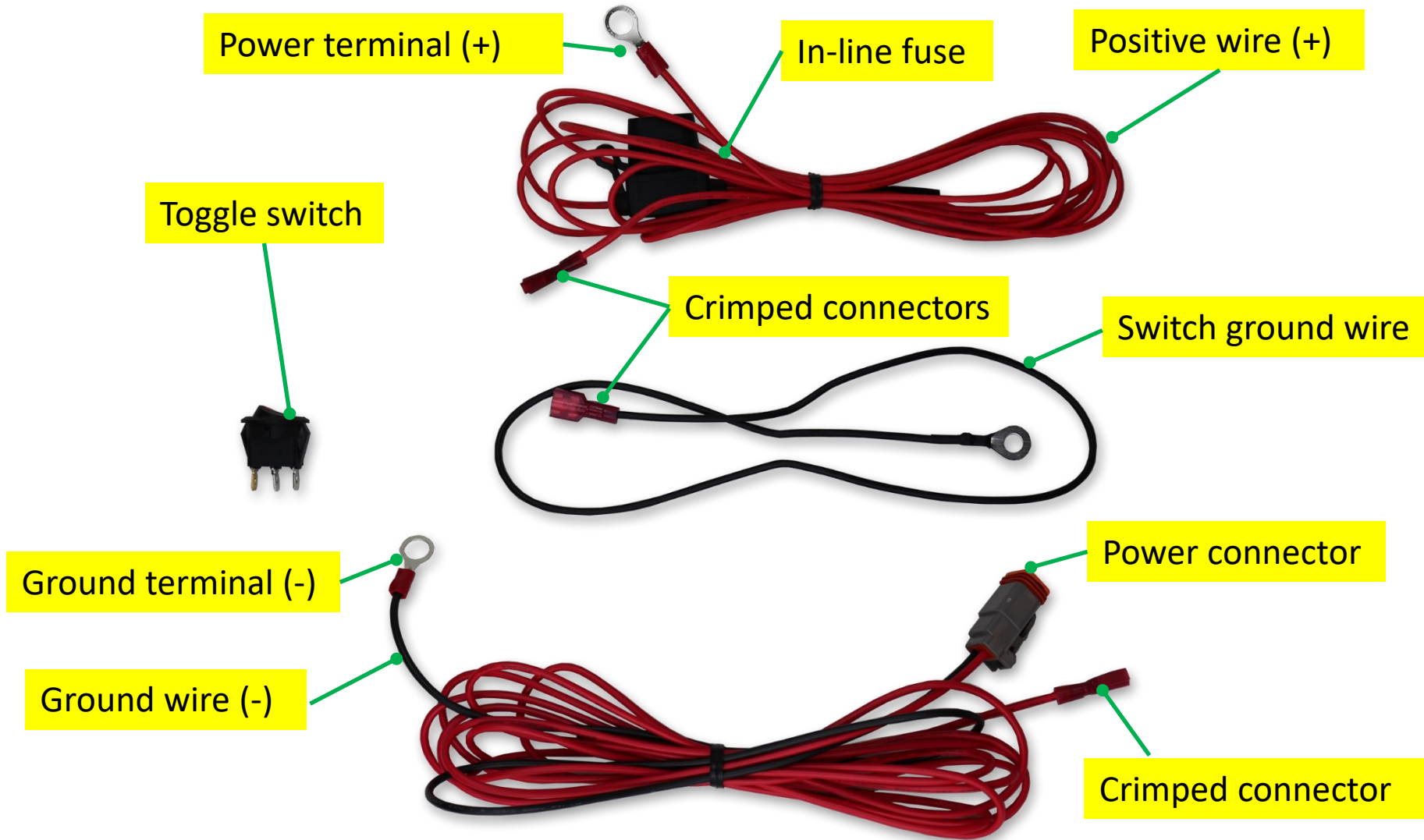



VELOSSA TECH

Wiring Harness Schematic

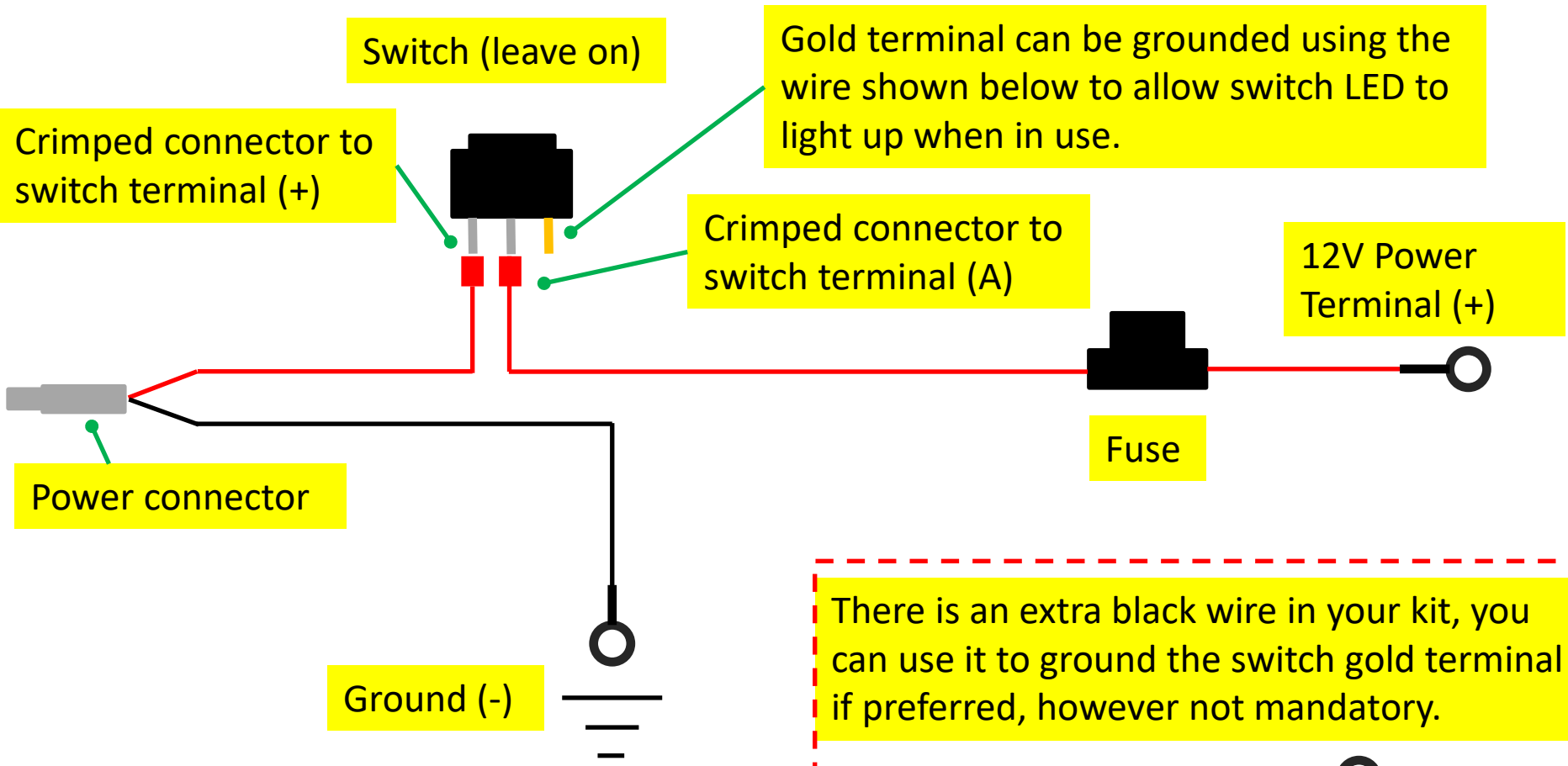

Switch (leave on)

Gold terminal can be grounded using the wire shown below to allow switch LED to light up when in use.

Crimped connector to switch terminal (+)

Crimped connector to switch terminal (A)

12V Power Terminal (+)

Fuse

Power connector

Ground (-)

There is an extra black wire in your kit, you can use it to ground the switch gold terminal if preferred, however not mandatory.

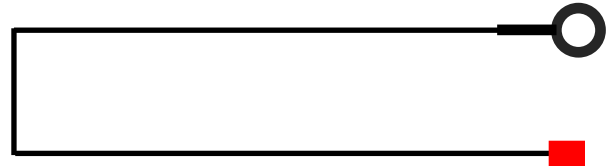

Controller

Zip tie the controller to the following location behind the driver side headlight. The controller is zip tied to the thick OEM electrical harness using two zip ties, one zip tie should loop through the DD controller slot and the other zip tie goes around the body and plug.

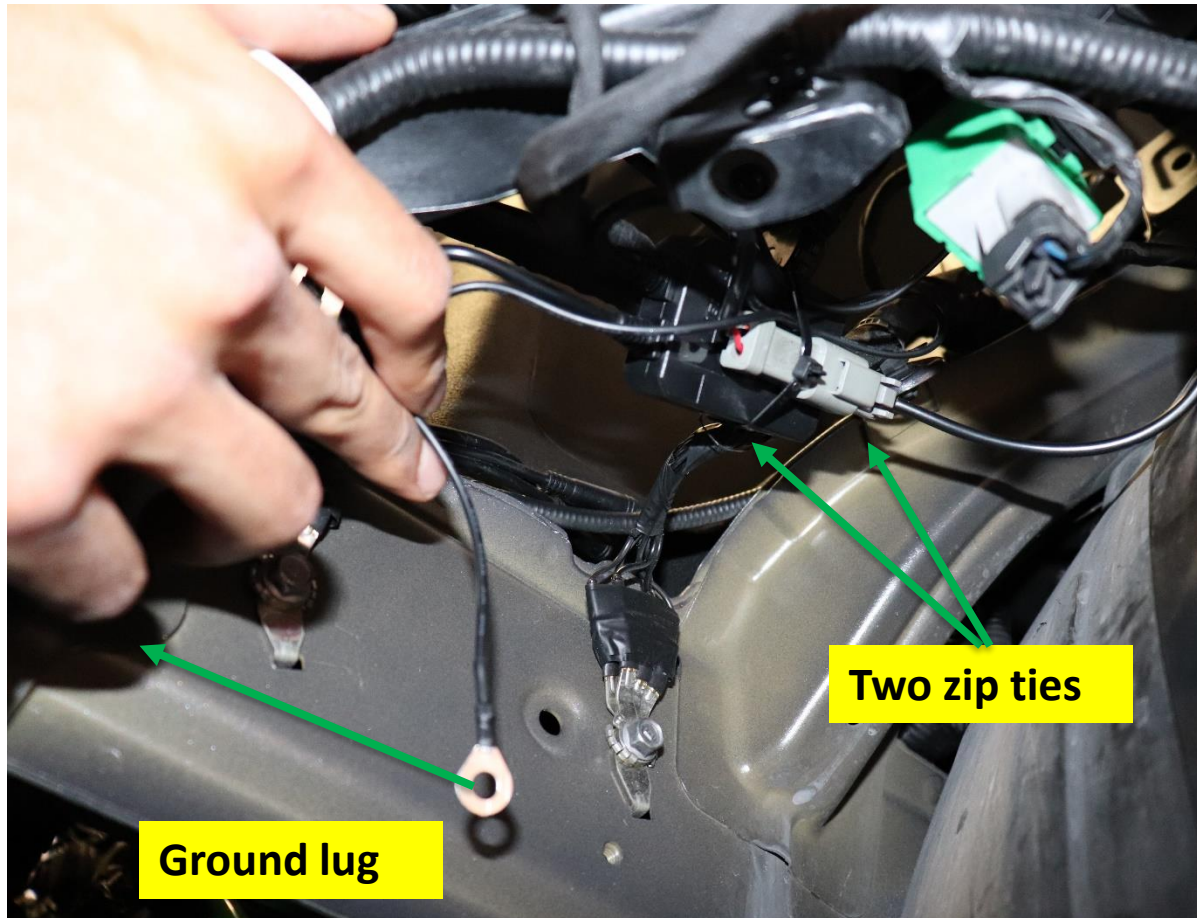

Controller

Ground the controller as shown with supplied 6mm bolt.

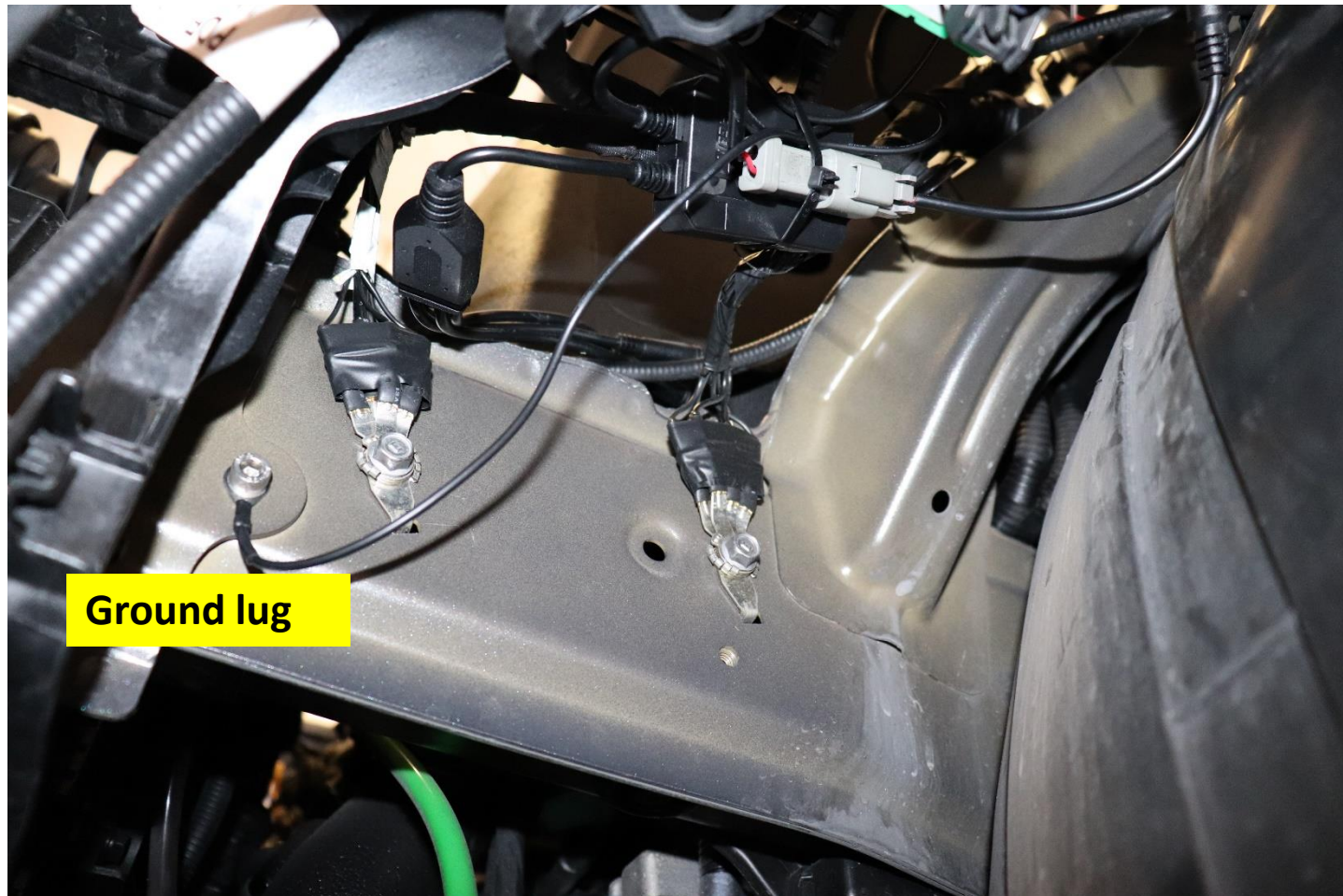

Wire Management

Snake the Diode Dynamics LED power wire from the BIG MOUTH as shown

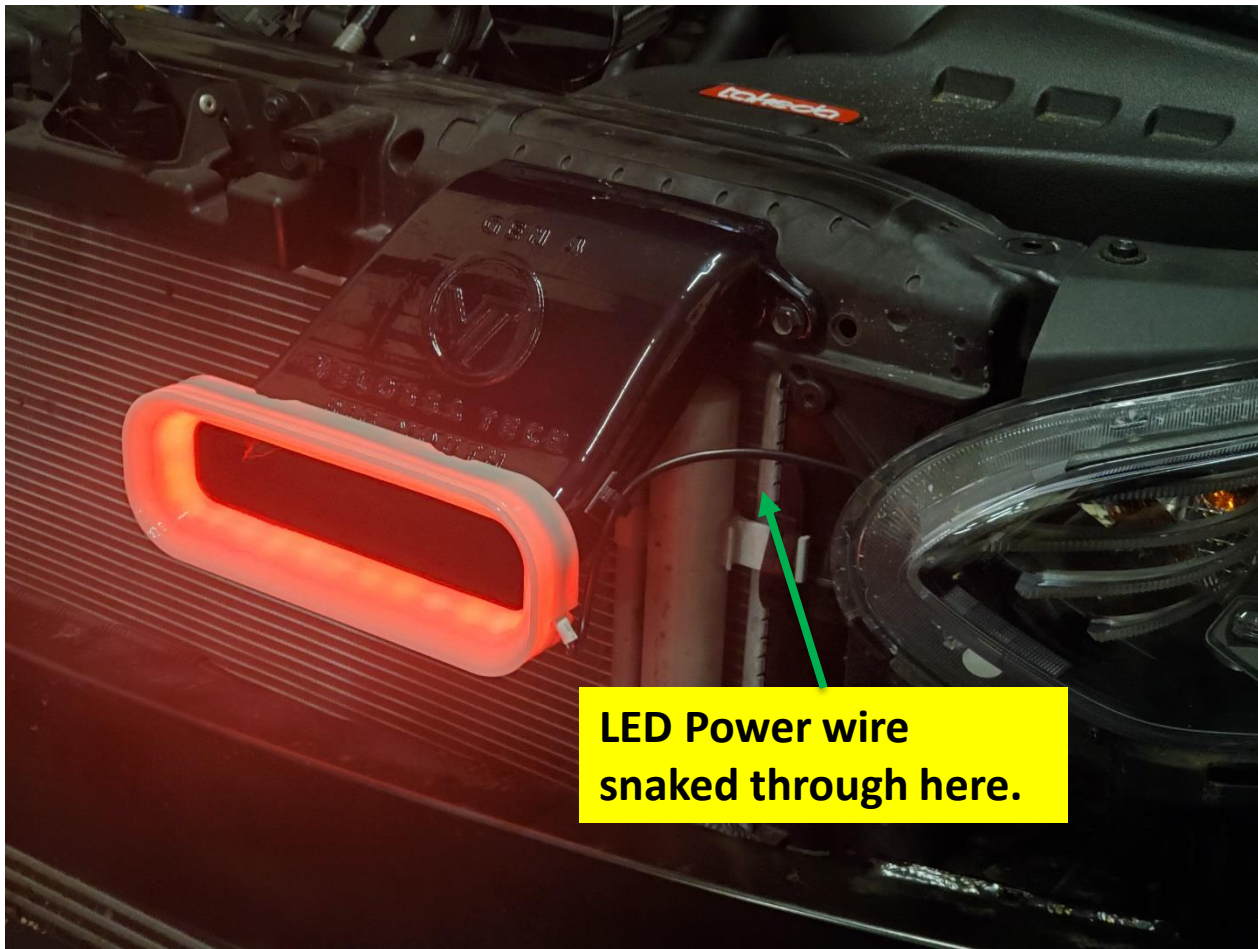

Wire Management

Zip tie the other 3 ports as shown

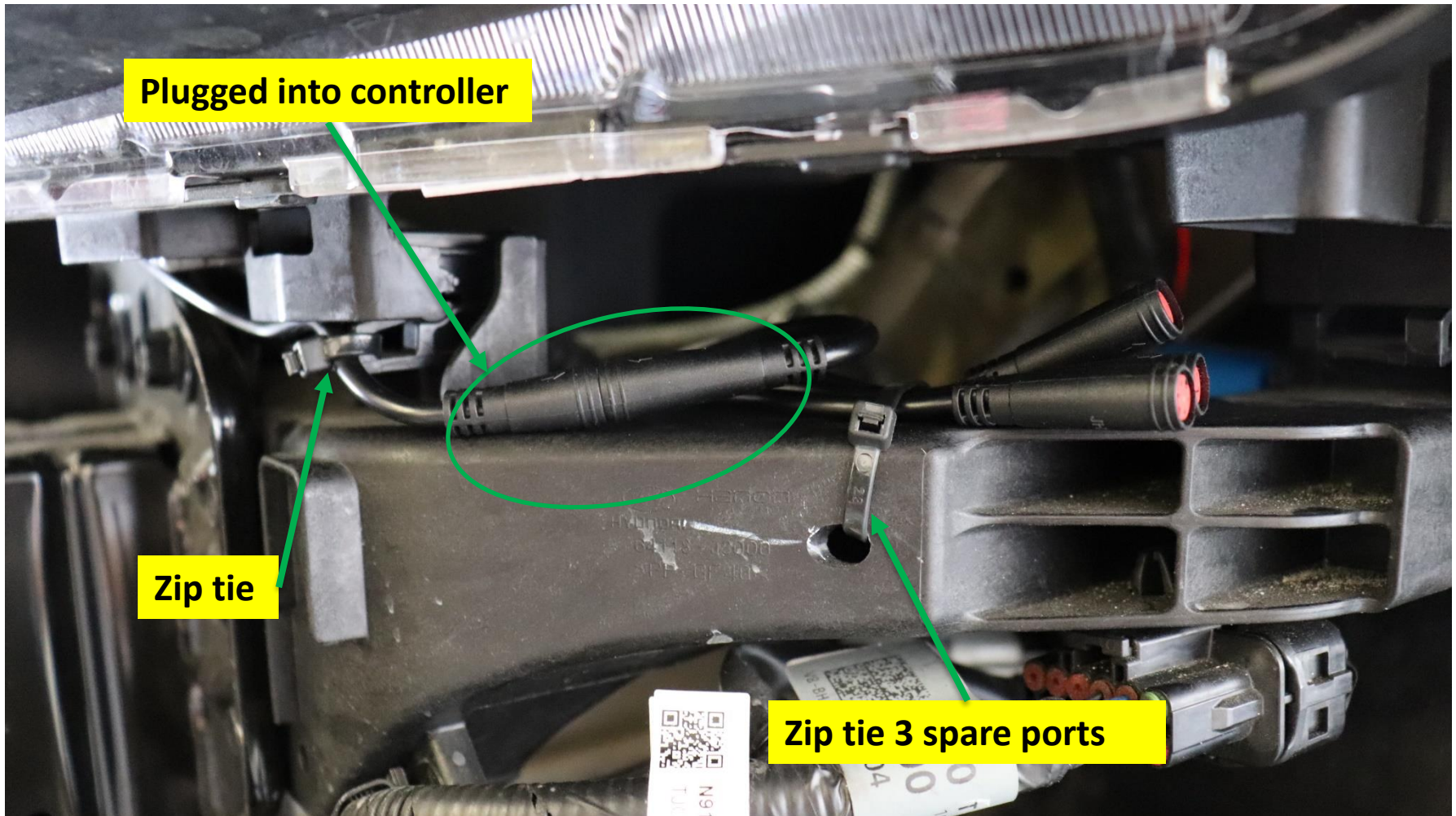

Power Hook-up

There will be excess power wire coming out of the power connector, bundle it neatly and zip tie, leave about a foot of power wire to make the power connection.

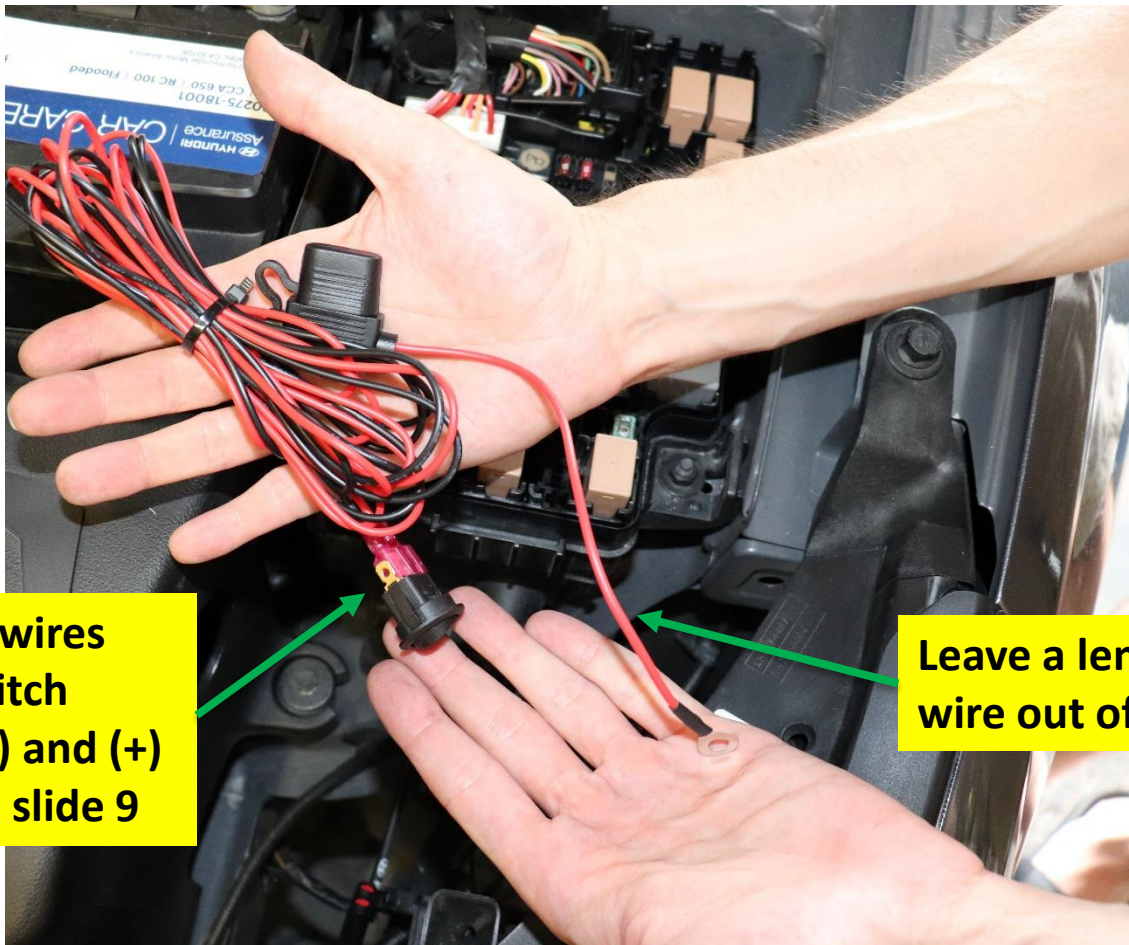

Both power wires plug into switch terminals (A) and (+) as shown on slide 9

Leave a length of power wire out of the bundle

Power Hook-up

Tuck away the bundle as shown, **fasten power lug to (+) terminal in the fuse box on top of the OEM stud, use supplied M6 nut.**

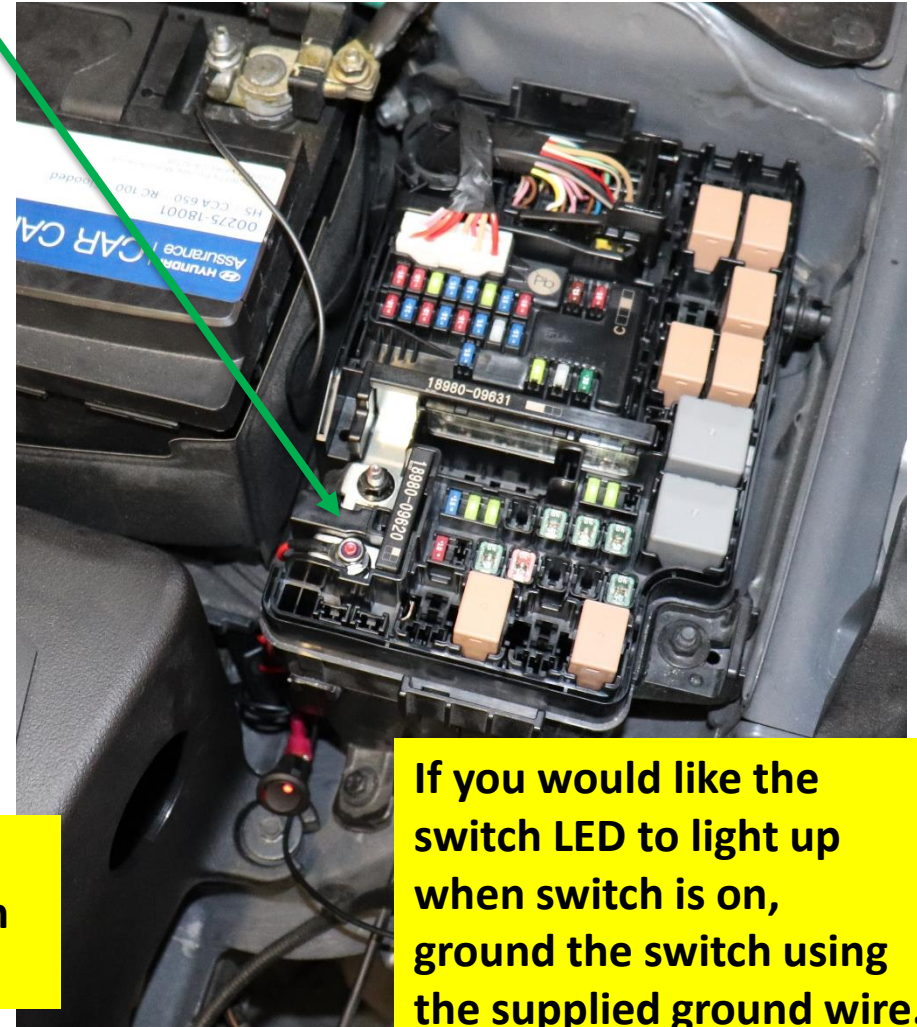
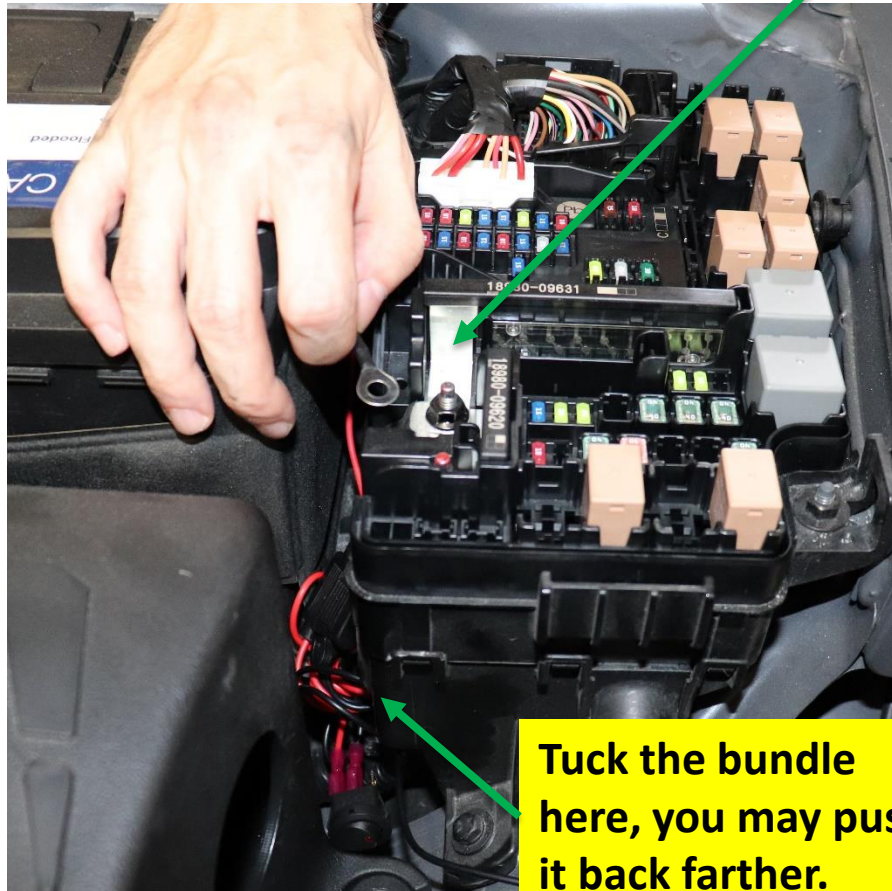

Power Hook-up

Switch ground: Optional

If you would like the switch LED to light up when switch is on, ground the switch using the supplied ground wire.

Once complete, put the fuse box cover back on, ensure no wires are pinched by the fuse box!

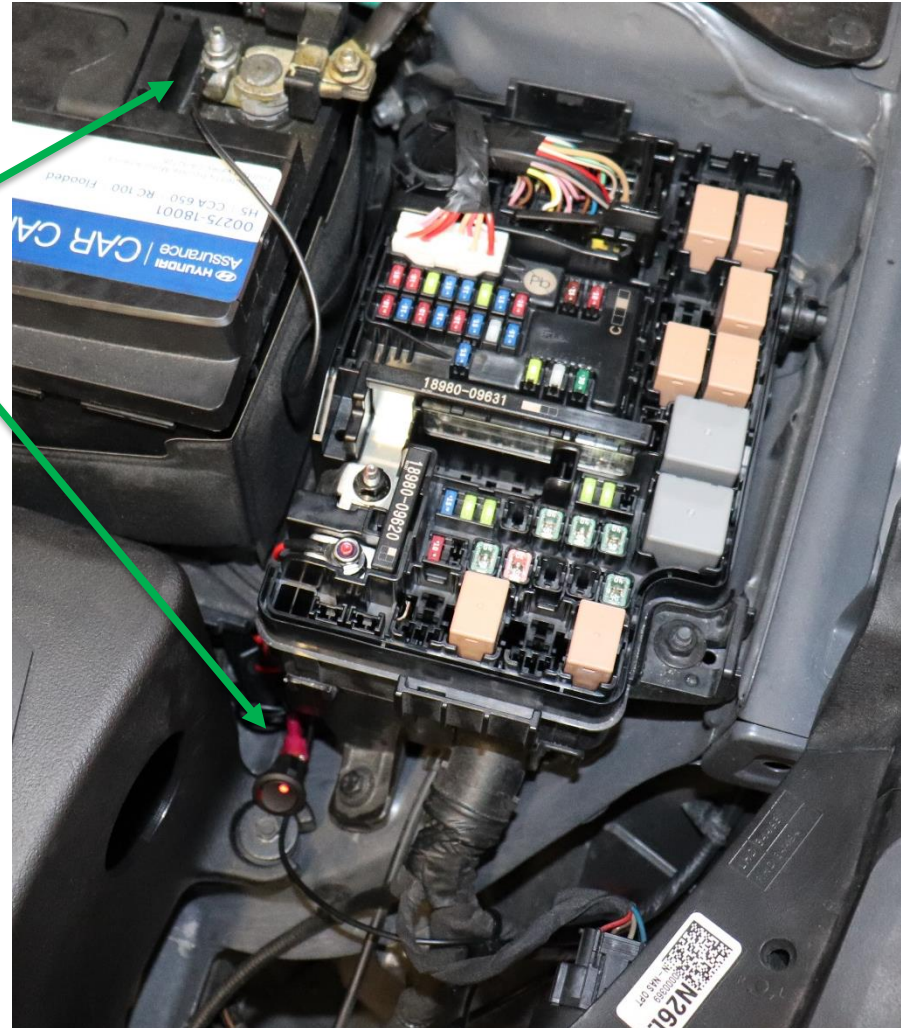

Phone App

Download the Diode Dynamics app and connect via Bluetooth.

How to connect to the app:

1. After installing the app from the app store, open the app on your device.
2. Cycle the power to the Bluetooth controller by unplugging it and plugging it back in or flick the power switch and wait a few seconds, then turn it back on.
3. Wait for the app to detect the controller, it will pop up on the app screen as a Bluetooth controller. If necessary, cycle the power once more to refresh the controller.
4. Once the controller shows up on the app, click it and connect. You have 30 seconds to select the controller once it shows up on the app. After 30 second you will need to refresh again to detect the controller again.
5. Note that if you mounted your controller behind a lot of metal components, this may degrade the signal and range.





VELOSSA TECH

Finalize

Re-install the bumper the same way it was removed and ENJOY!

