



**2022+ Ford Maverick BIG
MOUTH Lit Kit Installation Guide**

Kit Contents (Full Kit)

Please review this document before attempting installation.

You will need basic hand tools and 2 hours of installation time.

Kit Contents	Qty
M5 x 20mm Cap Screw	2
M5 lock nut	2
M5 large washer	2
Diode Dynamics RGBW Controller	1
Positive Cable w/ In-Line Fuse	1
Power Cable w/ Pigtail Connector	1
Switch	1
Switch Ground Cable w/ Crimped Connector	1
8" Zip Ties	8
Cable Clip	2
Assembled LIT KIT BIG MOUTH	1



Kit Contents (LIT Flare Only)

Please review the table below and make sure you have received the kit contents.

Kit Contents	Qty
Diode Dynamics RGBW Controller	1
Positive Cable w/ In-Line Fuse	1
Power Cable w/ Pigtail Connector	1
Switch	1
Switch Ground Cable w/ Crimped Connector	1
8" Zip Ties	8
Cable Clip	2
Assembled LIT KIT BIG MOUTH	1



If you already own the Velossa Tech Sonata N-Line BIG MOUTH, skip to slide 14 to see install and wiring instructions.

Stock Components Removal

It is best to Google “how to remove bumper” for your particular trim. Remove this duct by squeezing the two tabs along sides of the duct at the indicated points and pulling it off.

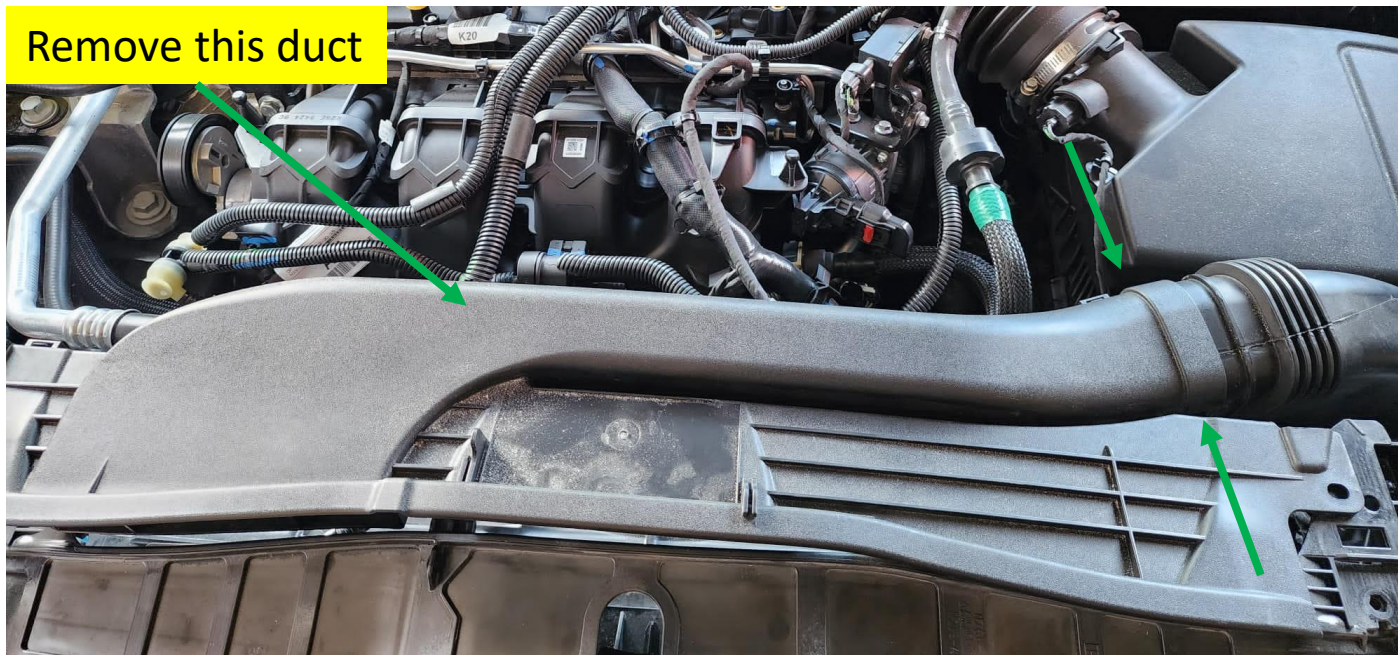

Disconnect Plug

Disconnect this plug (located near hood latch on the backside of the radiator shroud) to allow access to the hole concealed behind it.

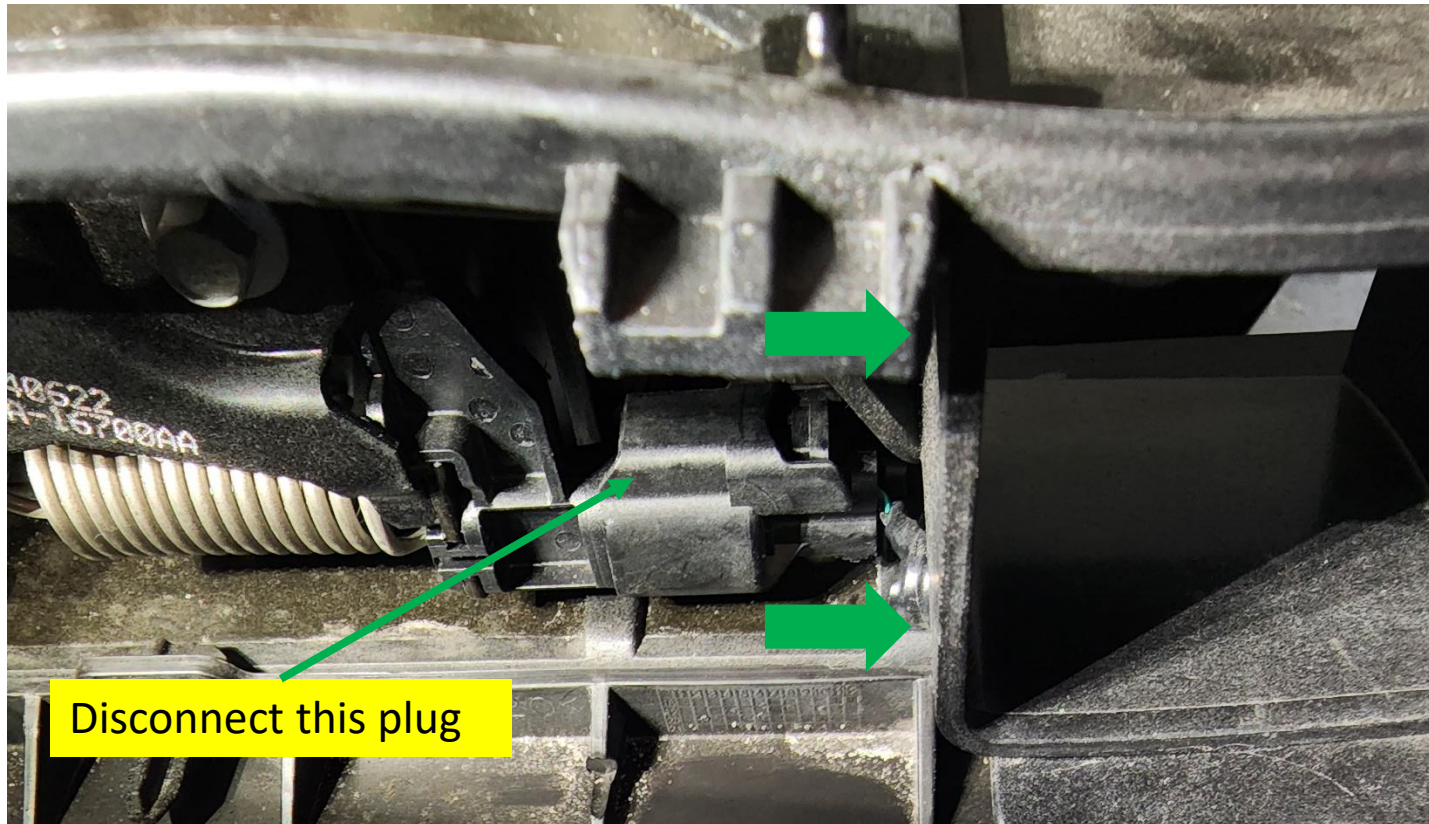

Remove Flaps

For the Big Mouth to fit, the top five grille shutters on the left half of the assembly will need to be removed. This can be done by flexing them enough such that the ends can be freed from their slots. Take precautions to avoid injury and damage to the radiator. These shutters will not be reinstalled but do not discard them.

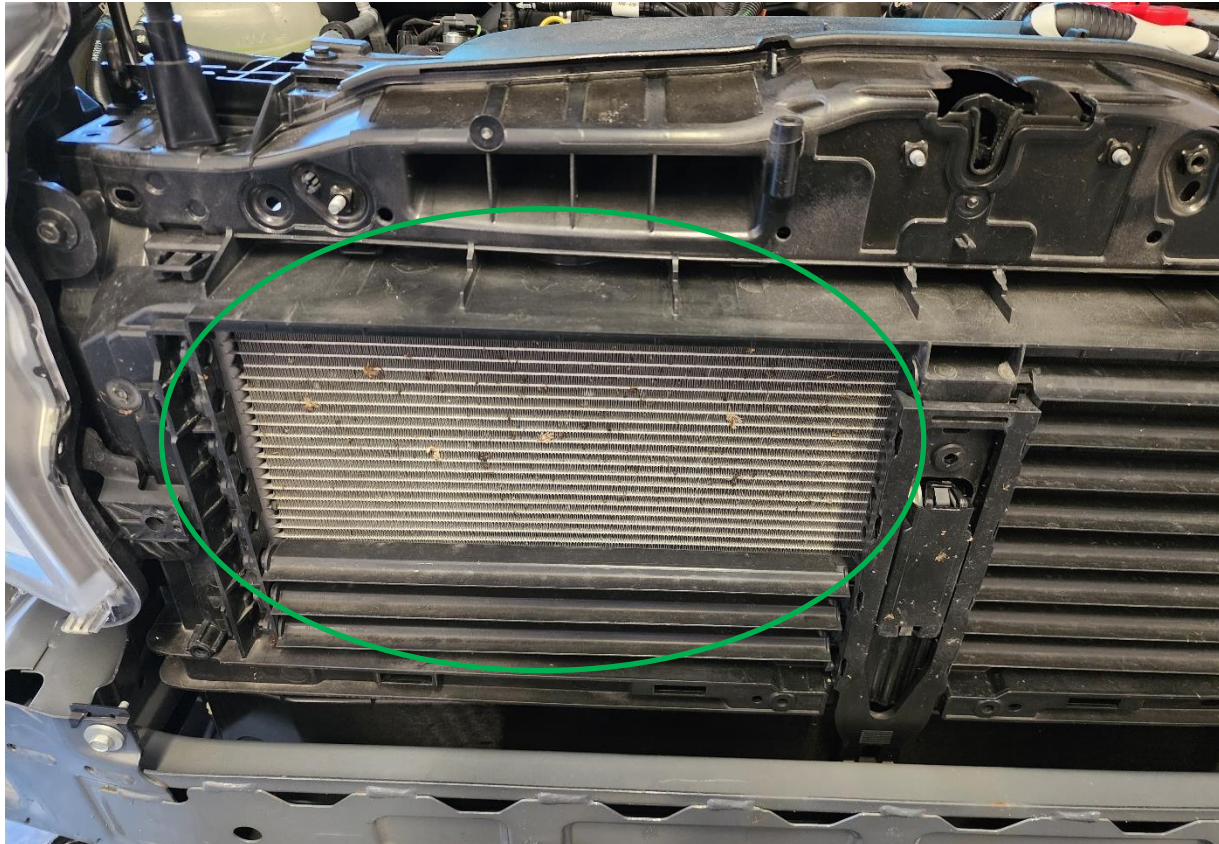

Trim Shroud

A requirement of the install is the trimming of the radiator shroud with the use of a Dremel and a cutoff blade. Use the references outlined in the images to mark the perimeter of the necessary cut and make the cut carefully. Enlarged versions of these images are provided in the next two slides. **Take the necessary precautions to protect yourself and the radiator.**





1

FT. & IN.
INCHES

2

25 FT.

3

4

Lafkin

5

6

MADE IN USA

7

FABRIQUÉ AUX
É.-U.

8

HECHO EN
E.U.A.

9

P.R. A
254



1
2
3
FT. & IN.
INCHES
25 FT.

Trim Cleanup

Use a deburring tool or file to clean up the edges left behind from the cut. The final cut should look like the one shown below.

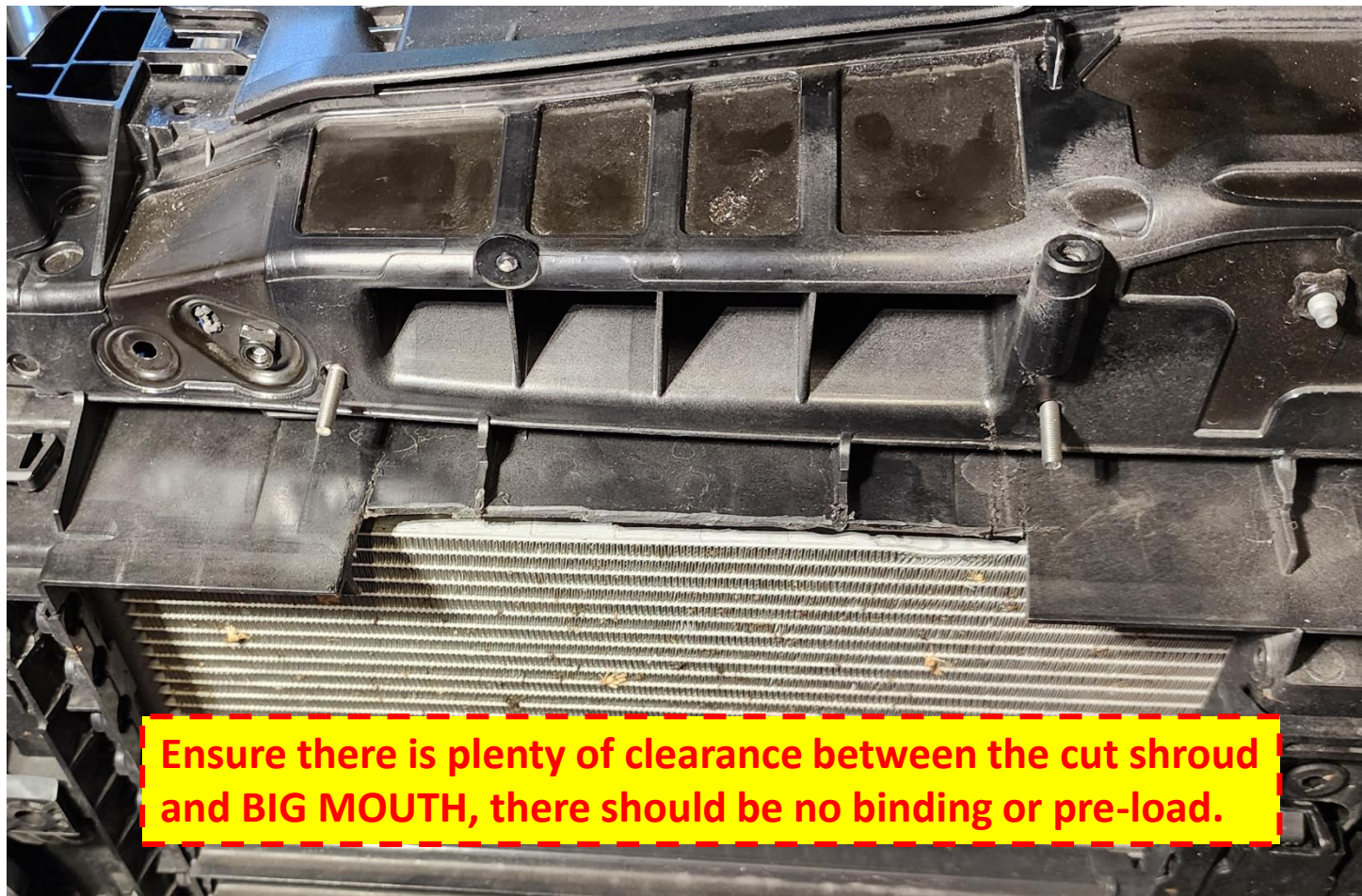

Fastening Points

The indicated holes are the ones that are being used to fasten the Big Mouth.

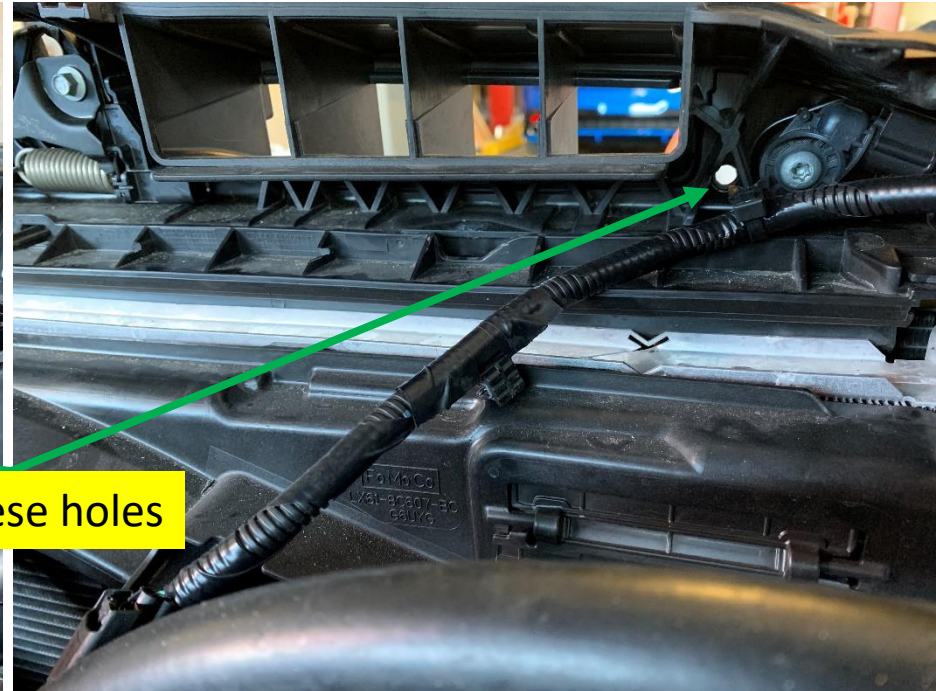
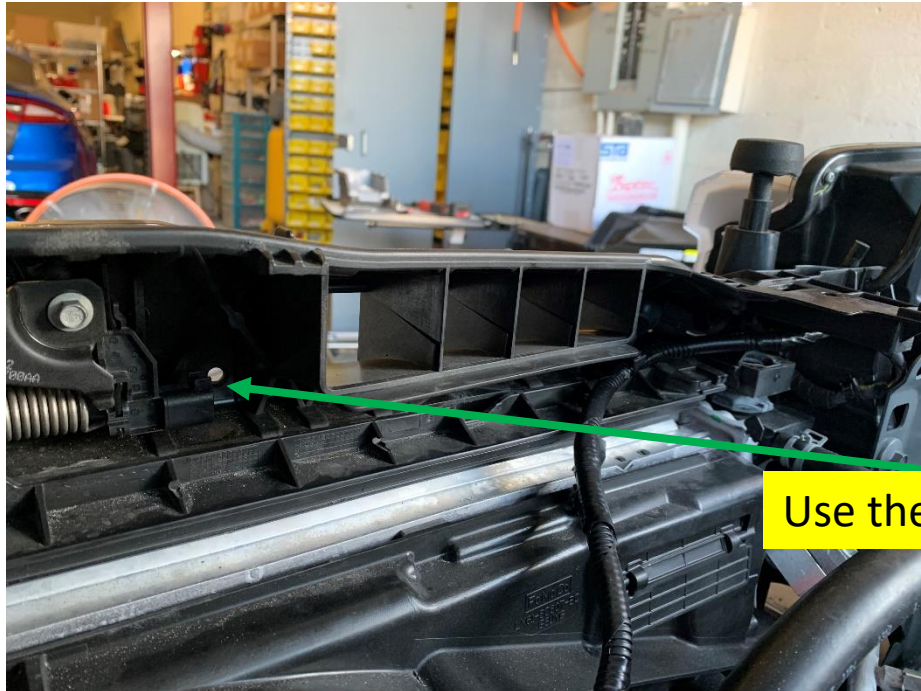

Use these holes

Install Big Mouth

Use the provided M5 x 20mm cap screws, washers and lock nuts to fasten the Big Mouth. **DO NOT OVERTORQUE.** It is not advised to tighten fully at this point until the Big Mouth is oriented correctly; the holes are oversized to allow for minor adjustments.

Bolt heads enters from the rear of the radiator support.

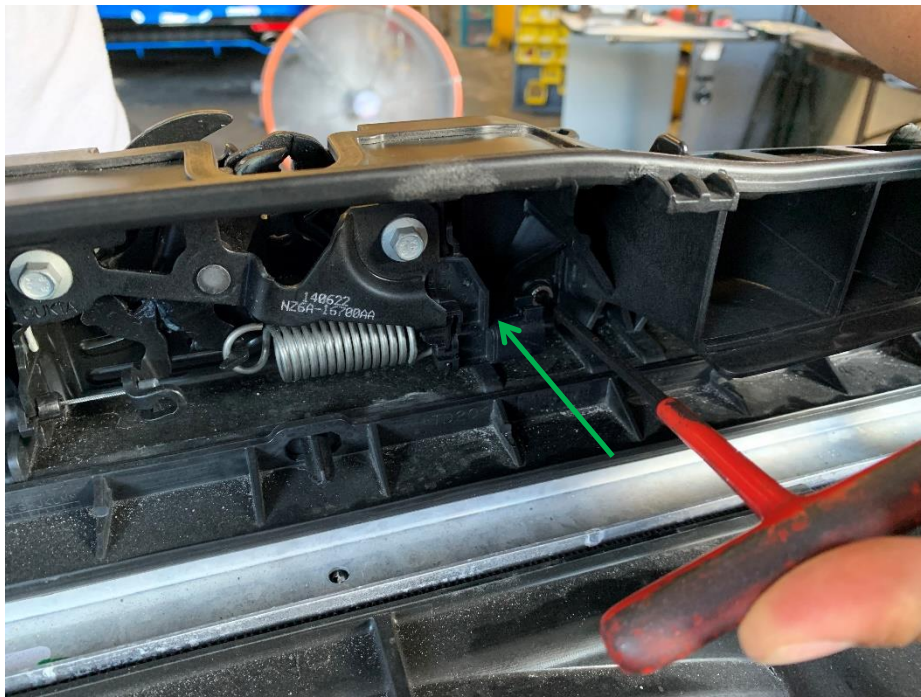

Adjust Big Mouth

Adjust the orientation of the Big Mouth by tightening the screws just enough to allow for minor tweaks. When it is properly positioned, tighten the screws. **DO NOT OVERTORQUE.**



Install the LIT BIG MOUTH Flare

SKIP THIS SLIDE IF YOU PURCHASED A FULL LIT KIT

Attach the supplied cable clip to your BIG MOUTH as shown. Fasten the cable and provide enough slack to not strain the cable.

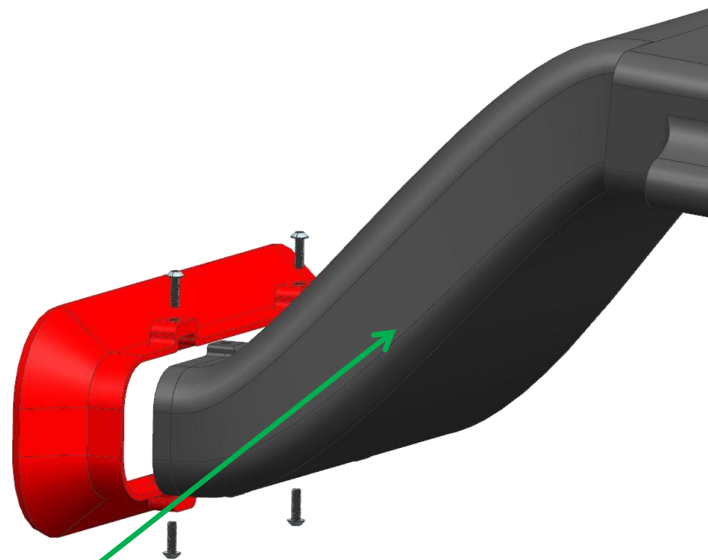

Attach the 3M cable clip here

If you purchased a LIT flare-only and already have a Gen 4 BIG MOUTH. Remove old flare and install the LIT flare with the 4 screws as shown.



VELOSSA TECH

Wiring Harness

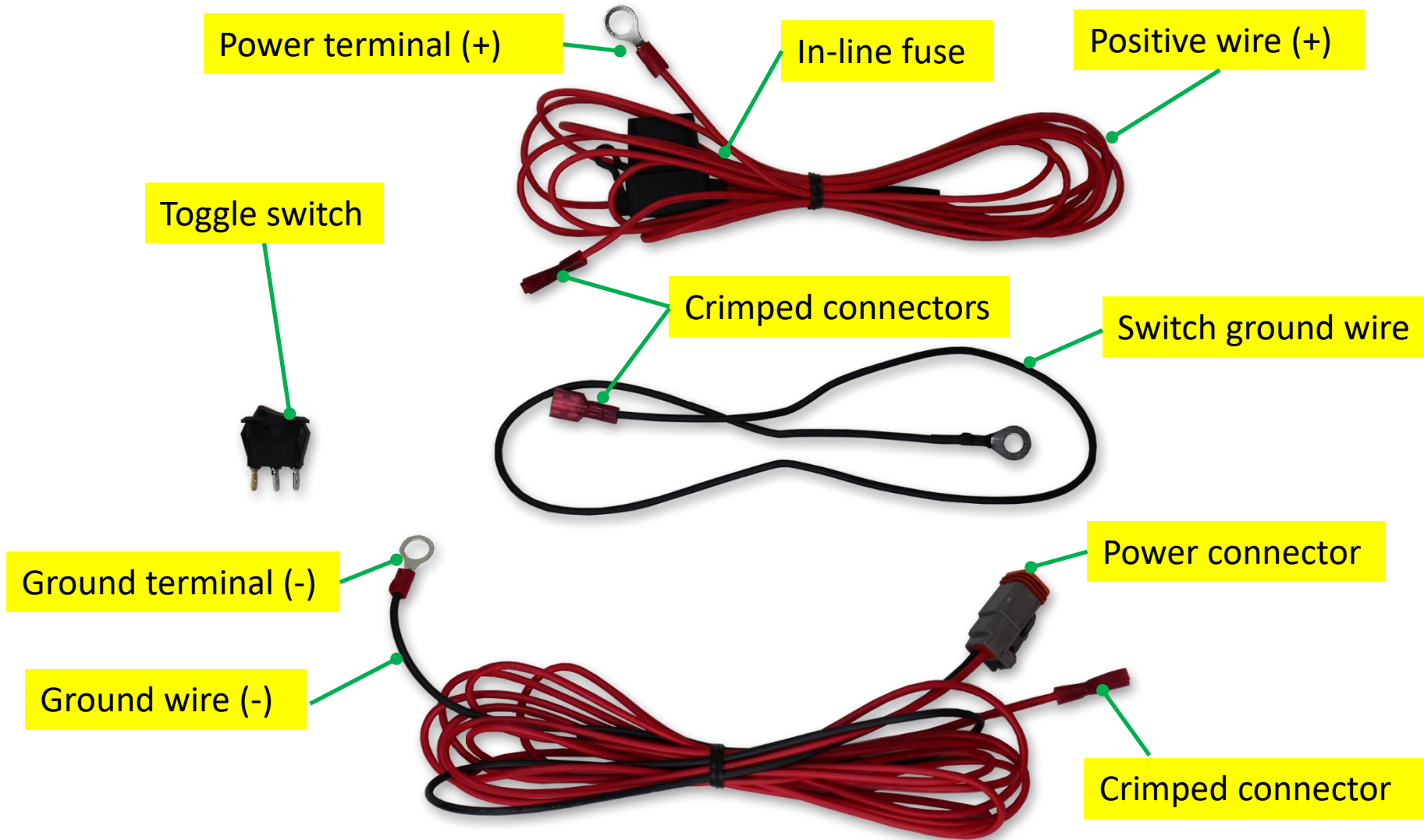



VELOSSA TECH

Wiring Harness Schematic

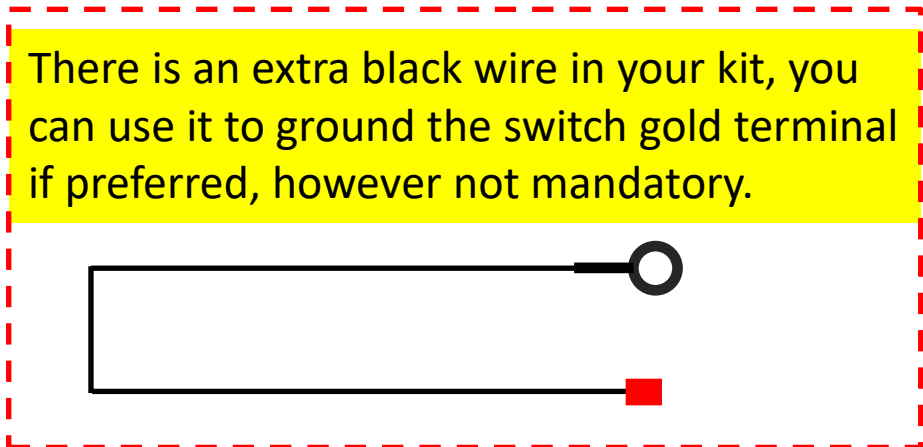
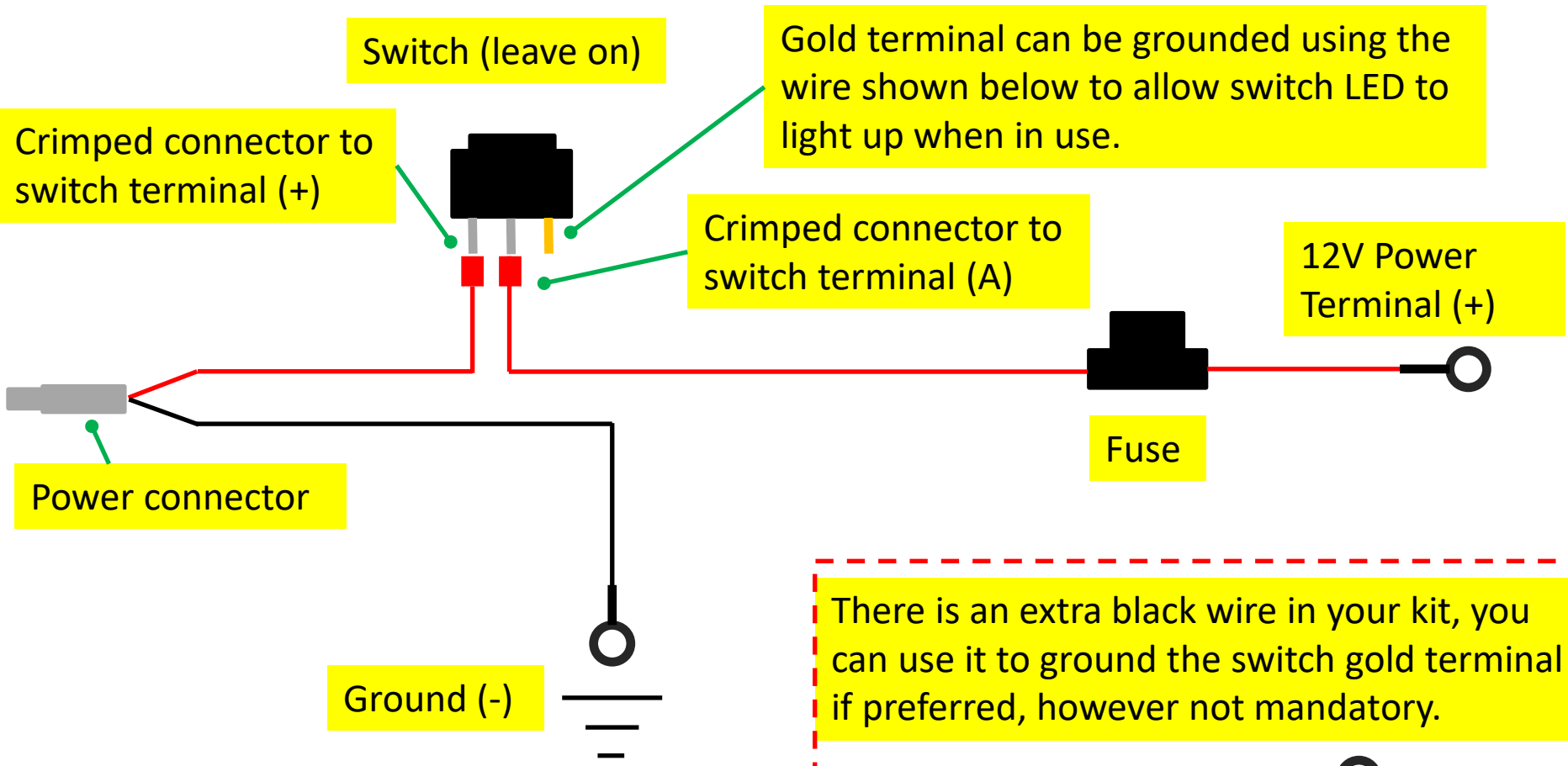

Drill Shroud

Drill a hole through the plastic radiator shroud to allow for proper routing of the wire. **From the back**, start with a small pilot hole (1/8") and incrementally increase bit size for an ultimate hole size of 3/8". **USE CAUTION.** Once the hole is drilled out, use a metal file to leave the hole free of burrs.

Pilot hole: 1/8"



It is not advised to go straight from a 1/8" to a 3/8" hole. Increase bit size incrementally to maintain control of the power tool and stay safe.

Controller Location

Clean the surface with a dry cloth and use the provided double-sided tape to adhere the Diode Dynamics controller to the shown location. **Ensure the cables are facing passenger side.**

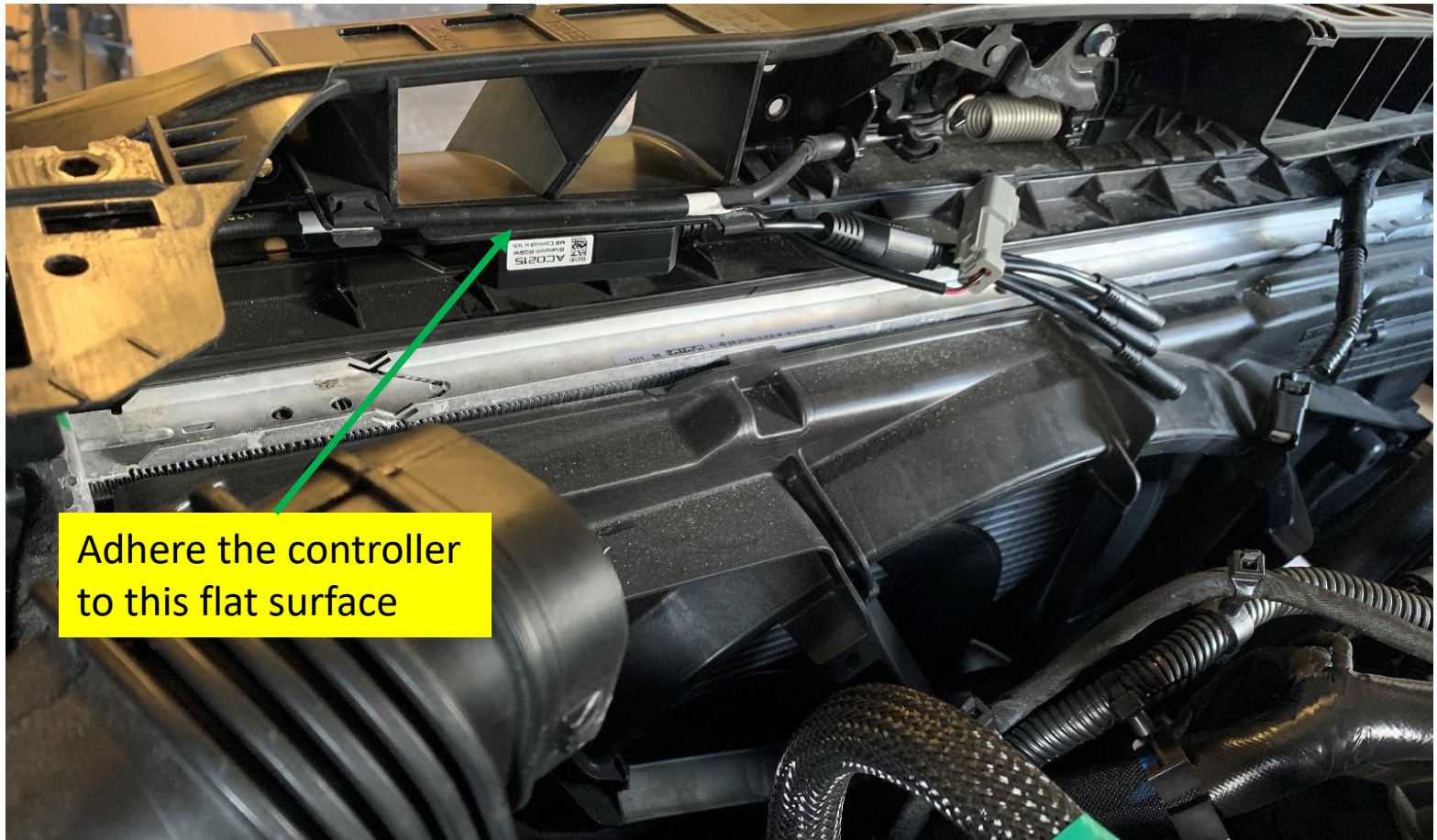

Big Mouth Wiring

Route the LED strip cable through the 3/8" hole and connect the LED strip to one of the controller ports (**line up the arrows on the connectors!**). The other 3 ports can accept any Diode Dynamics lighting strip for underglow or underhood lighting (sold separately).

Clean the surface and install one of the provided cable clips to fasten the cable.

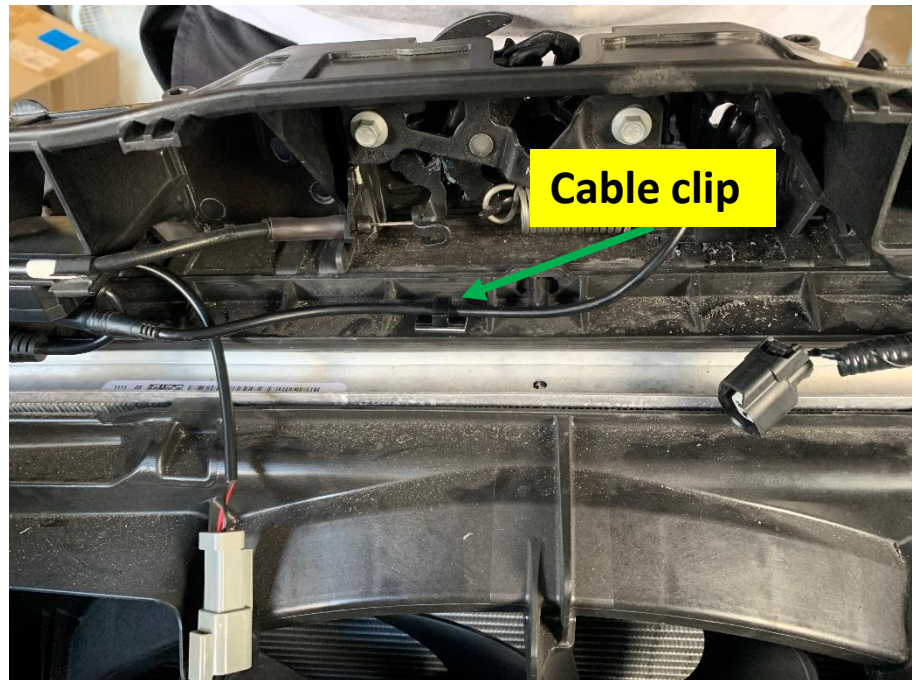
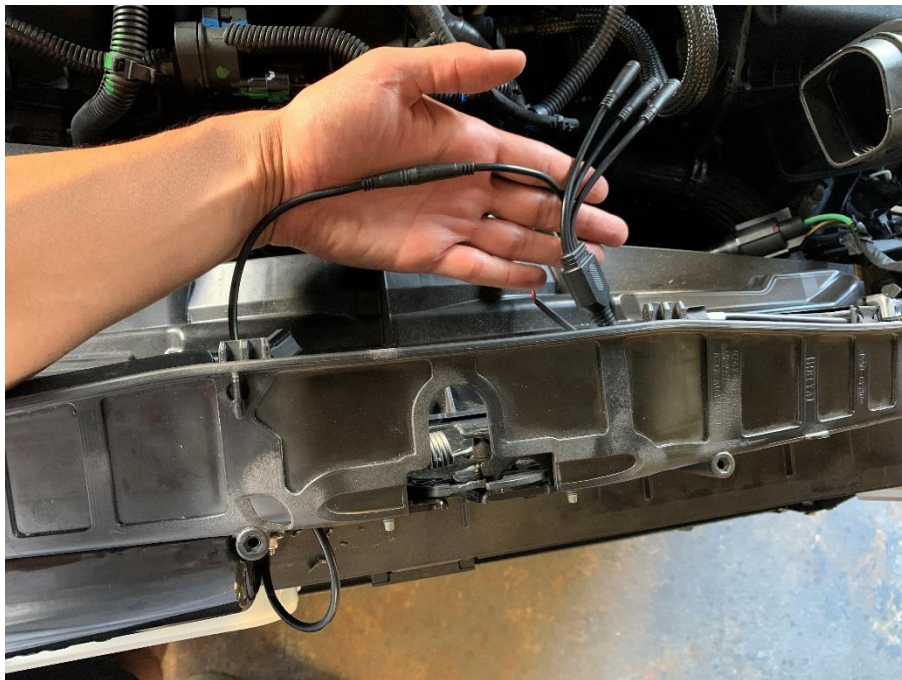

Big Mouth Wiring

Connect the grey pigtail connector to the controller and route all 3 spade connector ends of the wiring harness up through the indicated opening.

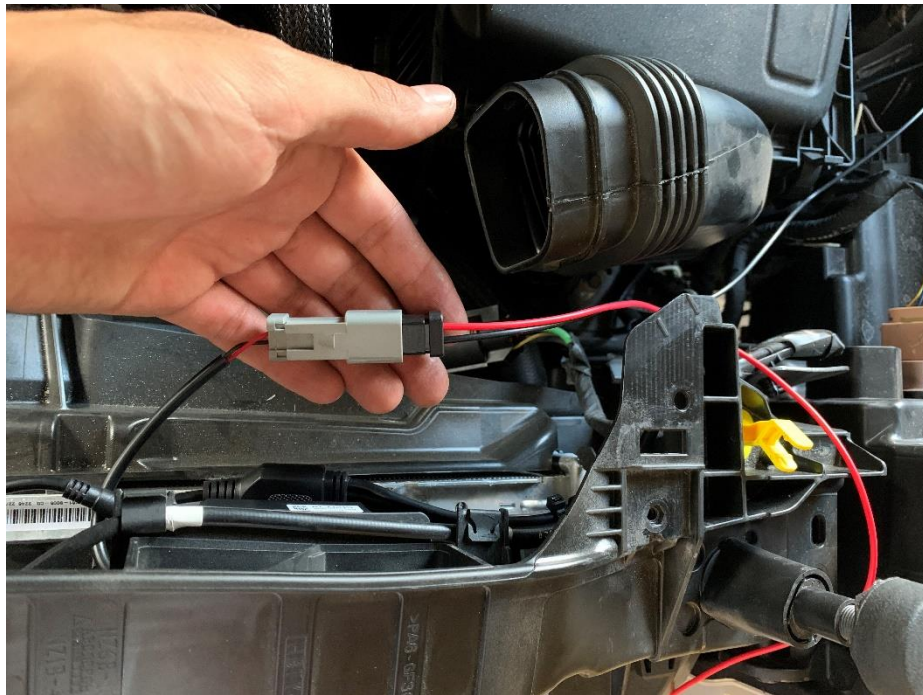

Big Mouth Wiring

Follow the wiring harness schematic (slide 16) to properly hook up the switch. Push firmly mount the switch in the opening.

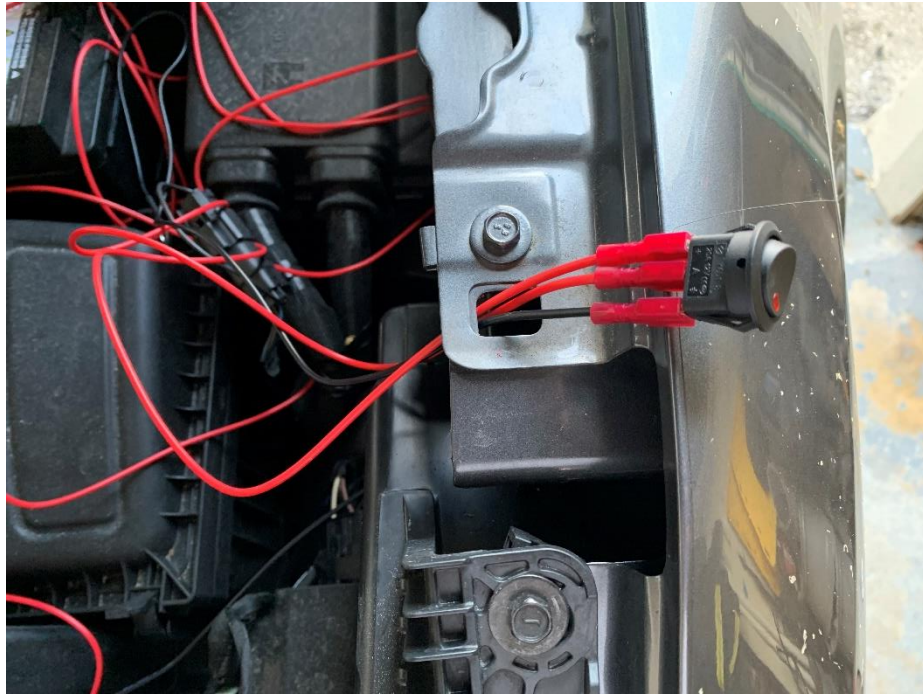

Big Mouth Wiring

Fasten the ground lugs to a point on the metal chassis. Use the provided zip ties to bundle the excess wire as shown below, making sure to leave approx. 2 ft of positive wire (red wire with the in-line fuse) to connect to the battery.

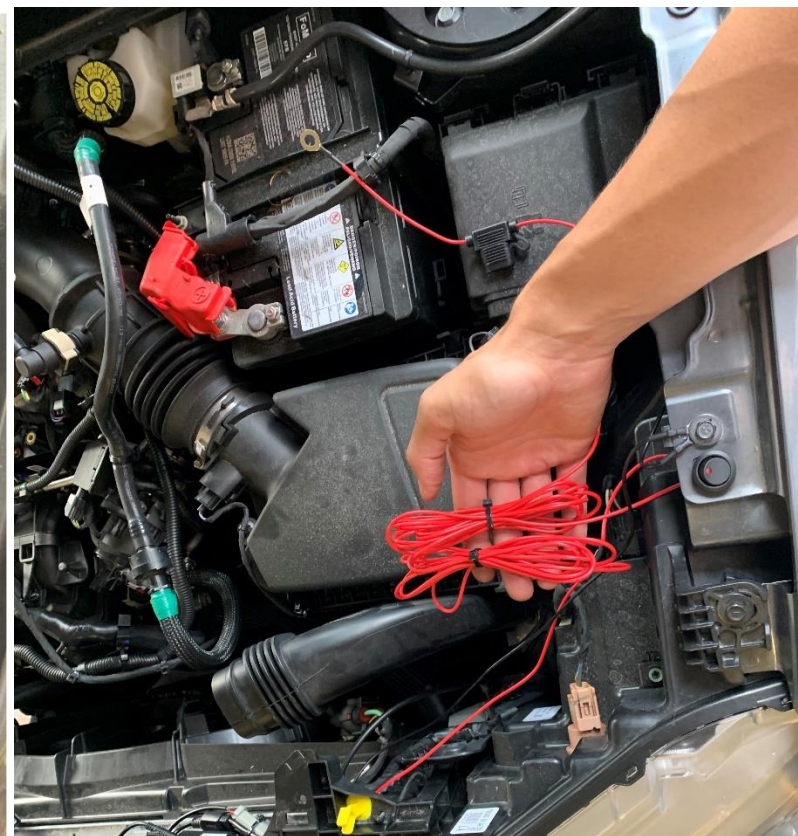
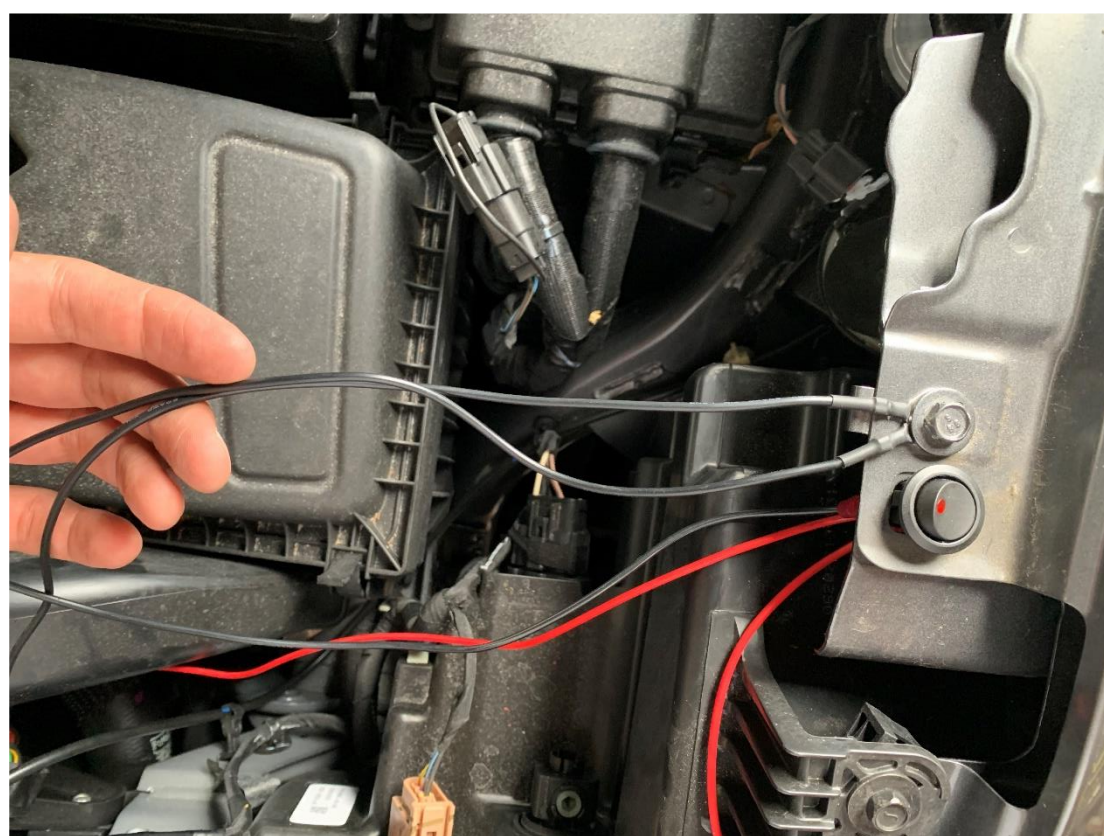

Big Mouth Wiring

Use the car battery to supply power to the Lit Kit. Undo the nut located on the positive terminal of the battery and fasten the power cable to it as shown. Take care to avoid damaging the wire when reinstalling the terminal cover.

Use any leftover zip ties and cable clips to organize and conceal any excess wire.

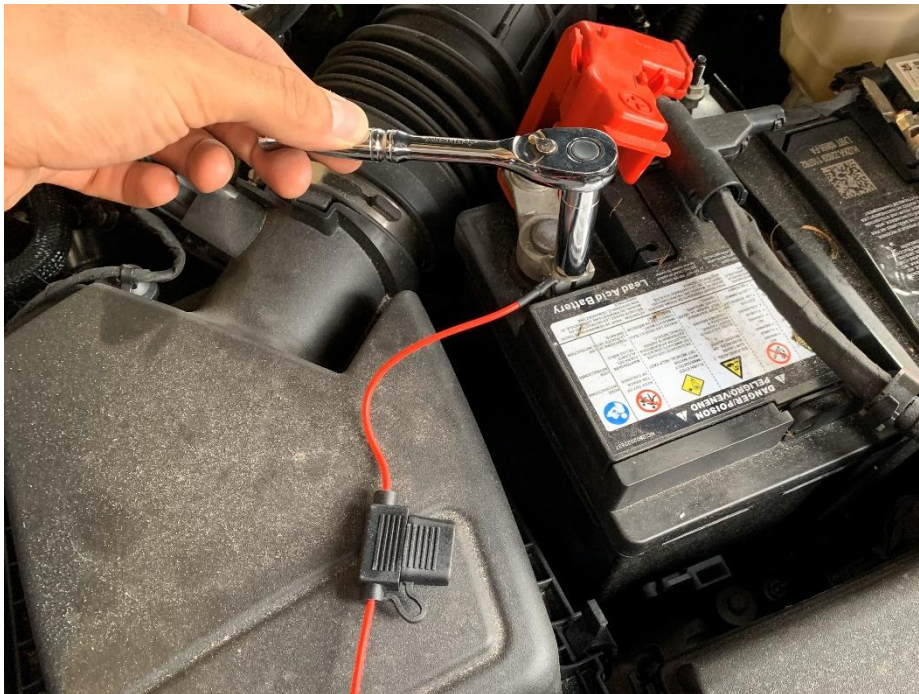

Phone App

Download the Diode Dynamics app and connect via Bluetooth.

How to connect to the app:

1. After installing the app from the app store, open the app on your device.
2. Cycle the power to the Bluetooth controller by unplugging it and plugging it back in or flick the power switch and wait a few seconds, then turn it back on.
3. Wait for the app to detect the controller, it will pop up on the app screen as a Bluetooth controller. If necessary, cycle the power once more to refresh the controller.
4. Once the controller shows up on the app, click it and connect. You have 30 seconds to select the controller once it shows up on the app. After 30 second you will need to refresh again to detect the controller again.
5. Note that if you mounted your controller behind a lot of metal components, this may degrade the signal and range.



Final Assembly Review

Review the install and make sure nothing is binding or causing any preload on any parts, loosen and retighten if adjustment is necessary.



Re-assemble the bumper the same way it was removed to complete installation.