

American Standard

HEATING & AIR CONDITIONING

ACONT602AF22MA

Programmable Comfort Control

Installation Instructions

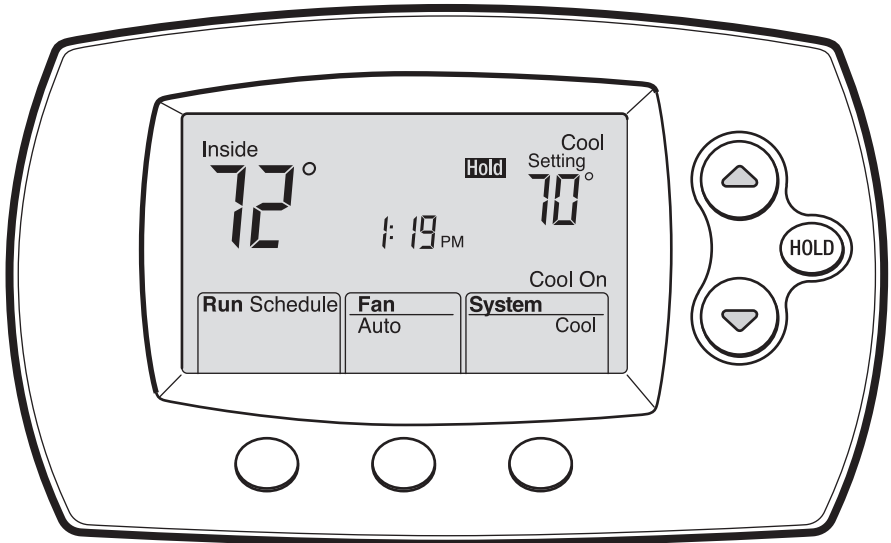

Pub. No. 11-HD02D11-3



69-1833-02



Product Application

This Comfort Control provides electronic control of 24 VAC single-stage and multi-stage heating and cooling systems.

System Types (up to 2 heat/2 cool)

- Gas, oil or electric heat with air conditioning
- Warm air, hot water, high-efficiency furnaces, heat pumps
- Heat only with fan
- Cool only

Power

- Common wire only
- Common wire with battery backup

Changeover Options

- Selectable manual or auto-changeover modes

System Settings

- Heat, Off, Cool, Auto, Em Heat

Fan Settings

- Auto, On

Must be installed by a trained, experienced technician

- Read these instructions carefully. Failure to follow these instructions can damage the product or cause a hazardous condition.
- Check the ratings in this booklet to verify that this product is suitable for your application (see page 14).
- Always test for proper operation after installation (see page 10).



CAUTION: ELECTRICAL HAZARD

Can cause electrical shock or equipment damage. Disconnect power before beginning installation.



MERCURY NOTICE

If this product is replacing a control that contains mercury in a sealed tube, do not place the old control in the trash. Contact your local waste management authority for instructions regarding recycling and proper disposal.

This thermostat contains a Lithium battery which may contain Perchlorate material. Due to State Law in CA, the following statement is required:
Perchlorate Material—special handling may apply,
See www.dtsc.ca.gov/hazardouswaste/perchlorate

Table of contents

Installation

Pre-installation checklist	2
Wallplate installation	3
Wiring	4
Wiring diagrams.....	5
Power options	7
Comfort Control mounting.....	7

Appendices

Quick reference to controls	12
Quick reference to display	12
Battery replacement	12
In case of difficulty	13
Accessories/replacement parts.....	14
Specifications	14

Setup and testing

Installer setup	8
Installer system test	10
Explanation of features.....	11

Installation tips

Install the Comfort Control about 5 feet (1.5m) above the floor in an area with good air circulation at average temperature.

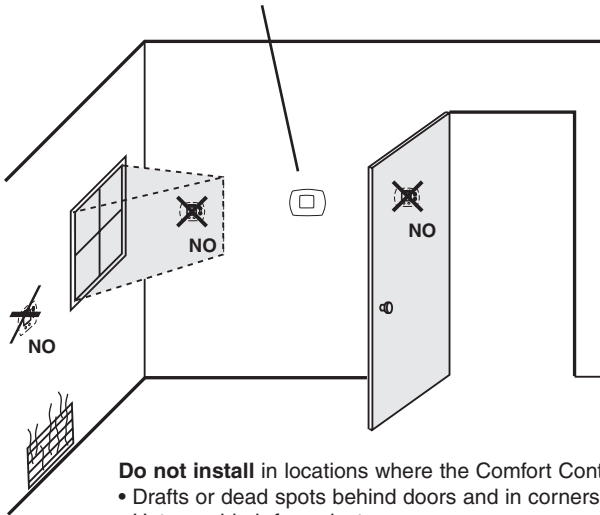

Do not install in locations where the Comfort Control can be affected by:

- Drafts or dead spots behind doors and in corners
- Hot or cold air from ducts
- Sunlight or radiant heat from appliances
- Concealed pipes or chimneys
- Unheated/uncooled areas such as an outside wall behind the Comfort Control

Pre-installation checklist

Package contents

Check to make sure your package includes the following items:

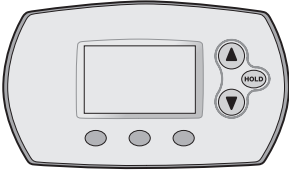

Programmable
Comfort Control
(wallplate attached to back)

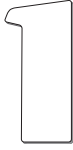

Quick
reference
card



Owner's Guide



Wall anchors and
mounting screws (2
each)



AA alkaline
batteries (2)

Required tools & supplies

- No. 2 Phillips screwdriver
- Small pocket screwdriver
- Drill
- Drill bit (3/16" for drywall, 7/32" for plaster)
- Hammer
- Pencil
- Electrical tape
- Level (optional)

Wallplate installation

Remove battery holder.

Pull here to remove wallplate from new Comfort Control.

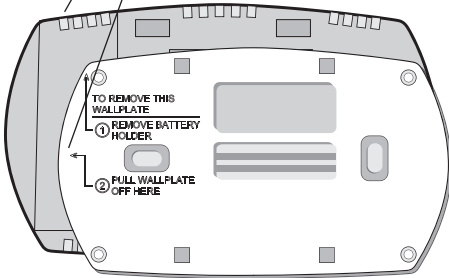

Insert quick reference card

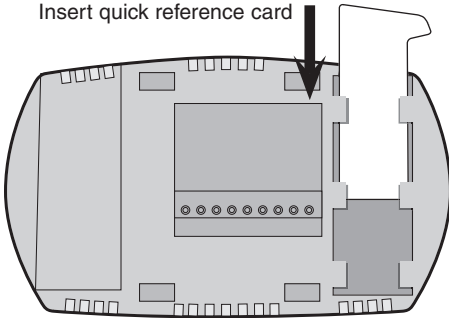

Drill 3/16" holes for drywall.
Drill 7/32" holes for plaster.

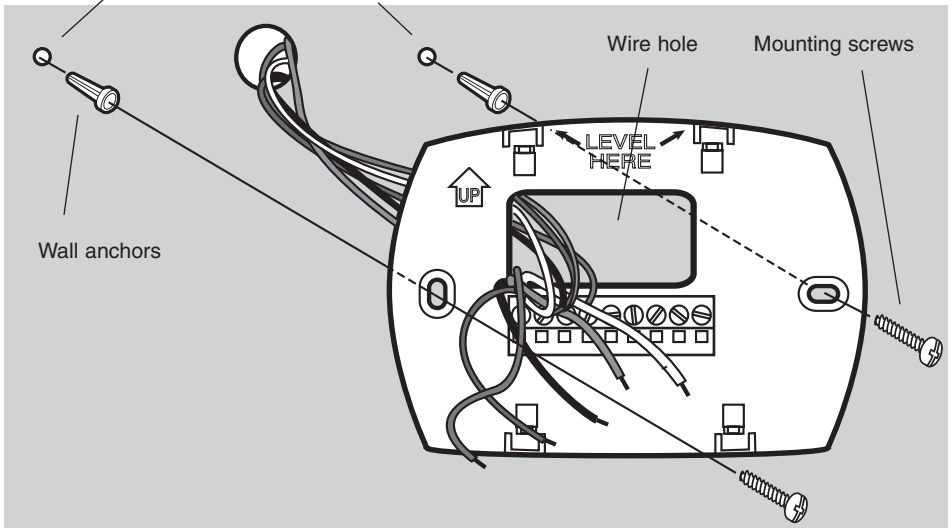

Remove the wallplate from the Comfort Control as shown at left, then follow directions below for mounting.

- 1 Insert quick reference card in slot in back of Comfort Control.
- 2 Pull wires through wire hole.
- 3 Position wallplate on wall, level and mark hole positions with pencil.
- 4 Drill holes at marked positions as shown below, then tap in supplied wall anchors.
- 5 Place wallplate over anchors, insert and tighten mounting screws.

Wiring

CAUTION: ELECTRICAL HAZARD. Can cause electrical shock or equipment damage. Disconnect power before wiring.

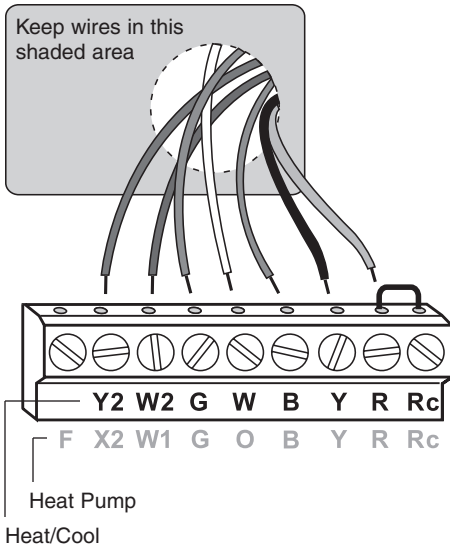

NOTES

R & Rc terminals

In single-transformer system, leave metal jumper in place between R & Rc. Remove metal jumper if two-transformer system.

B terminal

B is the common wire terminal.

W (O) terminal

If Comfort Control is configured for a heat pump in the Installer Setup, changeover valve is configured for cool ("O" factory setting).

F terminal (Output)

Heat pump reset. F terminal powered continuously when Comfort Control is set to Em Heat. Configure Comfort Control for 2 heat/1 cool heat pump in the Installer Setup.

Wire specifications

Use 18- to 22-gauge Comfort Control wire. Shielded cable is not required.

Wiring

- 1 Loosen screw terminals, insert wires into terminal block, then re-tighten screws.
- 2 Push excess wire back into the wall opening. Keep wires in shaded area as shown at left.
- 3 Plug the wall opening with non-flammable insulation to prevent drafts from affecting Comfort Control operation.

Terminal Designations

Conventional Terminal Letters:

- Y2** 2nd stage compressor contactor
- W2** 2nd stage heat relay
- G** Fan relay
- W** 1st stage heat relay
- B** Common wire from secondary side of cooling system transformer
- Y** 1st stage compressor contactor
- R** Heating power. Connect to secondary side of heating system transformer.
- Rc** Cooling power. Connect to secondary side of cooling system transformer.

Heat Pump Terminal Letters:

- F** Heat pump reset. F terminal powered continuously when System is set to Em Heat.
- X2** Emergency heat relay
- W1** Auxiliary heat relay
- G** Fan relay
- O** Changeover valve for heat pumps
- B** Common wire from secondary side of cooling system transformer.
- Y** Compressor contactor
- R** Heating power. Connect to secondary side of heating system transformer.
- Rc** Cooling power. Connect to secondary side of cooling system transformer.

Wiring diagrams

 Factory-installed jumper. Remove for 2-transformer systems only.

- Provide Power Supply disconnect means and overload protection as required.

Typical 1H/1C system: 1 transformer

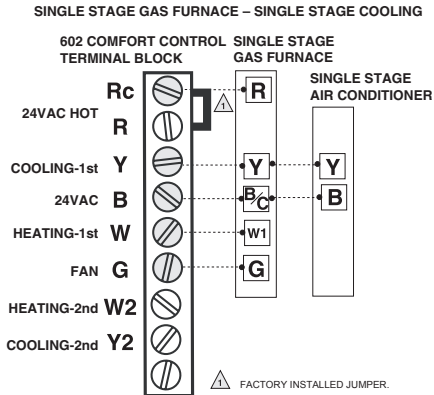

Typical 1H/1C system: 2 transformers

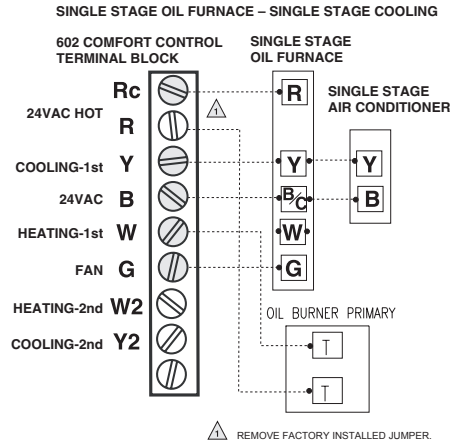

Typical 2H/1C system: 1 transformer

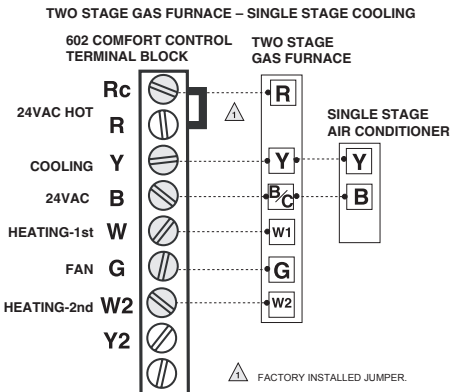

In Installer Setup, set system type to **2Heat/1Cool Conventional**.

Wiring diagrams

 Factory-installed jumper. Remove for 2-transformer systems only.

- Provide Power Supply disconnect means and overload protection as required

Typical 2H/2C system (1 transformer)

TWO STAGE VARIABLE SPEED GAS FURNACE – TWO STAGE COOLING

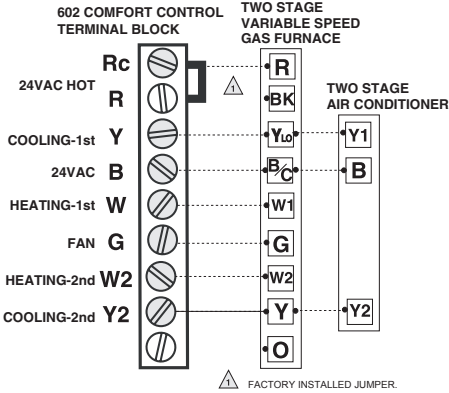

In Installer Setup, set system type to **2Heat/2Cool Conventional**.

Typical 2H/1C heat pump system

HEAT PUMP – AIR HANDLER -ELECTRIC HEATER 2H/1C

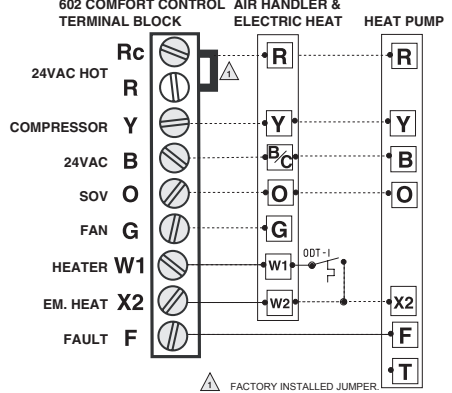

NOTE:
IF ODT-1 IS NOT USED, THEN CONNECT A JUMPER WIRE FROM W1 TO W2.

In Installer Setup, set system type to **2Heat/1Cool Heat Pump**.

F terminal is powered continuously when Comfort Control is set to Em Heat.

Install field jumper between W1 and X2 if there is no emergency heat relay.

2H/2C 16 SEER cooling system

TWO STAGE 16 SEER COOLING – TWO STAGE GAS FURNACE

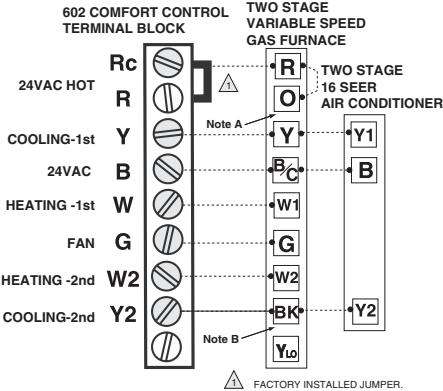

Note A - The installer must jumper at the LVTB "R" to "O"
Note B - Cut/remove the factory installed "BK" jumper.

In Installer Setup, set system type to **2Heat/2Cool Conventional**.

Power options & mounting

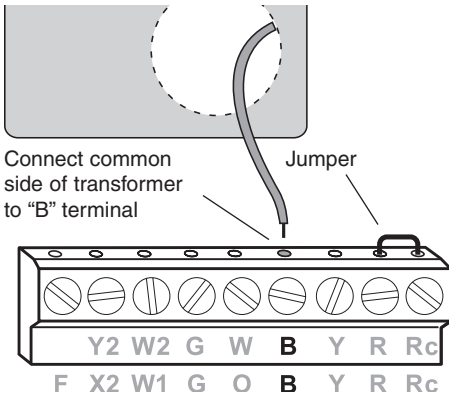

AC Power

The Comfort Control must be powered by 24 VAC power.

To wire the Comfort Control for AC power, connect the common side of the cooling transformer to the "B" terminal as shown at left.

Important: Remove R/Rc jumper for 2-transformer systems only. (See wiring diagram on page 5.)

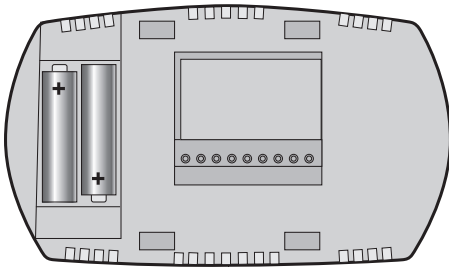

Battery Backup Power

The Comfort Control can be powered by backup batteries when used with AC power. During power interruptions the batteries will save time/day settings and power the display.

After installation, batteries can be changed without removing the Comfort Control from the wall (see page 12).

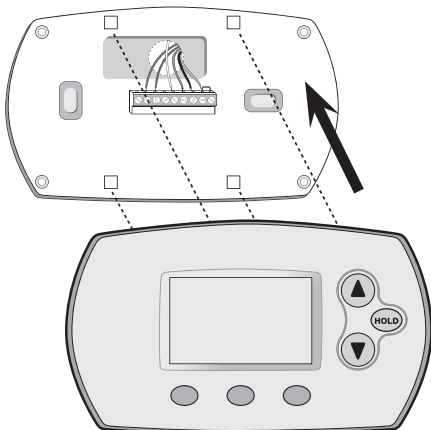

To Mount Comfort Control

Align the 4 tabs on the wallplate with corresponding slots on the back of the Comfort Control, then push gently until the Comfort Control snaps in place.

Installer setup

Follow the procedure below to configure the Comfort Control to match the installed heating/cooling system, and customize feature operation as desired.

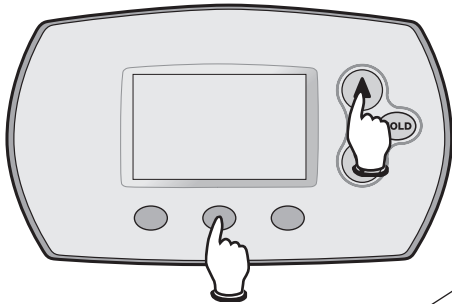

To begin, press and hold the ▲ and FAN buttons until the display changes

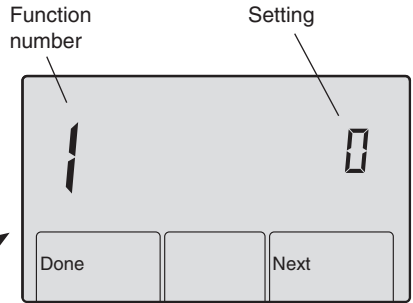

Press ▲ or ▼ to change settings
Press NEXT to advance to next function
Press DONE to exit and save settings

Setup Function

Settings & Options

1 System type

0 Gas, oil or electric heat with air conditioning

- 1 1 heat/1 cool heat pump
- 2 Heat only (2-wire systems/power to open & close zone valves/normally open zone valves)
- 3 Heat only with fan
- 4 Cool only
- 5 2 heat/1 cool heat pump
- 6 2 heat/2 cool conventional
- 7 2 heat/1 cool conventional
- 8 1 heat/2 cool conventional

3 Fan control (heating)

0 Gas or oil furnace — equipment controls fan in heating

- 1 Electric furnace — Comfort Control controls fan in heating

5 Heat cycle rate (CPH: cycles/hour)

5 For gas or oil furnaces of less than 90% efficiency

- 1 For steam or gravity systems
 - 3 For hot water systems & furnaces of over 90% efficiency
 - 9 For electric furnaces
- [Other cycle rate options: 2, 4, 6, 7, 8, 10, 11 or 12 CPH]

6 Second stage heat cycle rate/ Auxiliary heat (CPH)

5 For gas or oil furnaces of less than 90% efficiency

- 1 For steam or gravity systems
 - 3 For hot water systems & furnaces of over 90% efficiency
 - 9 For electric furnaces
- [Other cycle rate options: 2, 4, 6, 7, 8, 10, 11 or 12 CPH]

Continued on next page >

Installer setup

Follow the procedure below to configure the Comfort Control to match the installed heating/cooling system, and customize feature operation as desired.

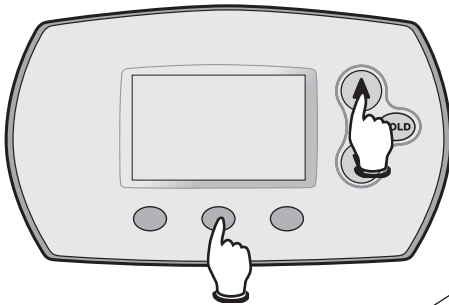

To begin, press and hold the ▲ and FAN buttons until the display changes

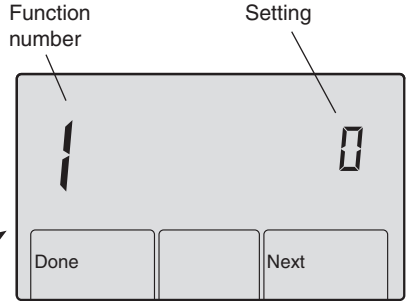

Press ▲ or ▼ to change settings
 Press NEXT to advance to next function
 Press DONE to exit and save settings

Setup Function

Settings & Options (BOLD is “as shipped” settings)

- | | |
|---|---|
| <p>8 Emergency heat cycle rate (CPH)</p> <p>9 Compressor cycle rate (CPH)</p> <p>10 Second stage compressor cycle rate (CPH)</p> <p>12 System setting adjustment</p> <p>13 Adaptive Intelligent Recovery™</p> <p>14 Temperature display</p> <p>15 Compressor protection</p> <p>16 Schedule format</p> <p>27 Heat temperature range stops</p> <p>28 Cool temperature range stops</p> <p>31 Dehumidification Control</p> | <p>9 For electric emergency heat
 1 For steam or gravity systems
 3 For hot water systems & furnaces of over 90% efficiency
 5 For gas or oil furnaces of less than 90% efficiency
 [Other cycle rate options: 2, 4, 6, 7, 8, 10, 11 or 12 CPH]</p> <p>3 Recommended for most compressors
 [Other cycle rate options: 1, 2, 4, 5 or 6 CPH]</p> <p>3 Recommended for most compressors
 [Other cycle rate options: 1, 2, 4, 5 or 6 CPH]</p> <p>0 Manual changeover (Heat/Cool/Off)
 1 Auto changeover (Heat/Cool/Auto/Off) **See page 11
 2 Auto changeover only (Auto) **See page 11</p> <p>1 On **See page 11
 0 Off</p> <p>0 Fahrenheit
 1 Celsius</p> <p>5 Five-minute compressor off time **See page 11
 [Other options: 0, 1, 2, 3 or 4-minute off time]</p> <p>0 5/2 (programmable weekdays and weekends)
 1 5/1/1 (weekdays, Saturday & Sunday programmable)</p> <p>90 Highest heating temperature setting
 40-89 Heating temperature range (increments of 1°F, or 0.5°C)</p> <p>60 Lowest cooling temperature setting
 61-99 Cooling temperature range (increments of 1°F, or 0.5°C)</p> <p>1 Cooling Droop
 2 Cooling Droop with Comfort-R™ (15 seconds Fan Delay)
 3 Cooling Droop with Comfort-R™ (30 seconds Fan Delay)
 0 None</p> |
|---|---|

Installer system test

Follow the procedure below to test the heating, cooling and fan.

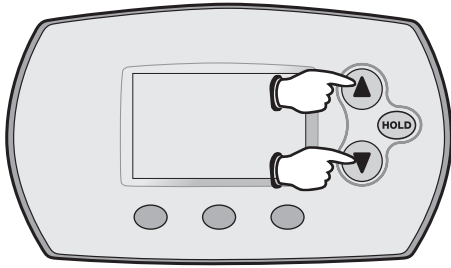

To begin, press and hold the ▲ and ▼ buttons until the display changes

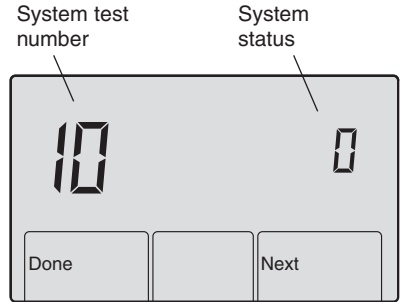

Press ▲ to turn on system
 Press ▼ to turn off system
 Press **NEXT** to advance to next test
 Press **DONE** to terminate system test

System Test

System Status

10 Heating system	0 Heat and fan turn off 1 Heat turns on. Fan also turns on immediately if Function 1 is set to "1" or "5," or if Function 3 is set to "1" **See page 8 2 Second stage heat turns on
20 Emergency heating system	0 Heat and fan turn off 1 Heat and fan turn on 2 Second stage heat turns on (Aux)
30 Cooling system	0 Compressor and fan turn off 1 Compressor and fan turn on 2 Second stage compressor turns on
40 Fan system	0 Fan turns off 1 Fan turns on
70 Comfort Control information (for reference only)	71 Software revision number (major revisions) 72 Software revision number (minor revisions) 73 Configuration identification code (major) 74 Configuration identification code (minor) 75 Production configuration date code (week) 76 Production configuration date code (year)



CAUTION: EQUIPMENT DAMAGE HAZARD

Compressor protection (minimum off time) is bypassed during testing. To prevent equipment damage, avoid cycling the compressor quickly.

Auto Changeover (Setup Function 12)

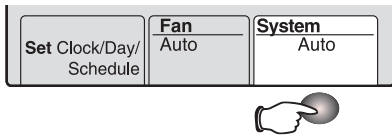

Auto Changeover is a feature used in climates where both air conditioning and heating are used on the same day. When the system is set to Auto, the Comfort Control automatically selects heating or cooling depending on the indoor temperature.

Heat and cool settings must be at least 3-degrees apart. The Comfort Control will automatically adjust settings to maintain this 3-degree separation (called “deadband”).

The 3-degree separation between heating and cooling set temperatures is fixed, and cannot be changed.

Adaptive Intelligent Recovery™ (Setup Function 13)

Adaptive Intelligent Recovery eliminates guesswork when setting your schedule. It allows the thermostat to “learn” how long your furnace and air conditioner take to reach the temperature you want.

Just set your program schedule to the time you want the house to reach your desired temperature. The Comfort Control then turns on the heating or cooling at just the right time to reach your scheduled temperature at your scheduled time.

For example: Set the Wake time to 6 am, and the temperature to 70°. The heat will come on before 6 am, so the temperature is 70° by the time you wake at 6.

Built-in compressor protection (Setup Function 15)

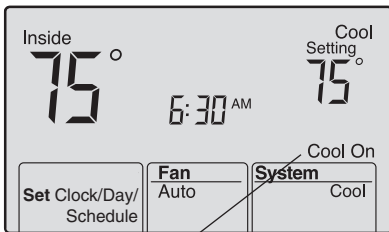

Message flashes until safe restart time has elapsed

This feature helps prevent damage to the compressor in your air conditioning or heat pump system.

Damage can occur if the compressor is restarted too soon after shutdown. This feature forces the compressor to wait for a few minutes before restarting.

During the wait time, the message Cool On or Heat On (heat pumps only) will flash on the display. When the safe wait time has elapsed, the message stops flashing and the compressor turns on.

Quick reference to controls

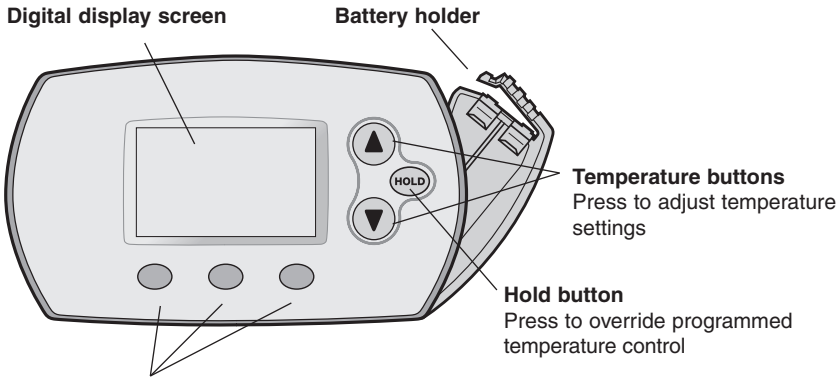

Function buttons

Press to select the function displayed just above each button.
(Functions change depending on the task.)

Quick reference to display screen

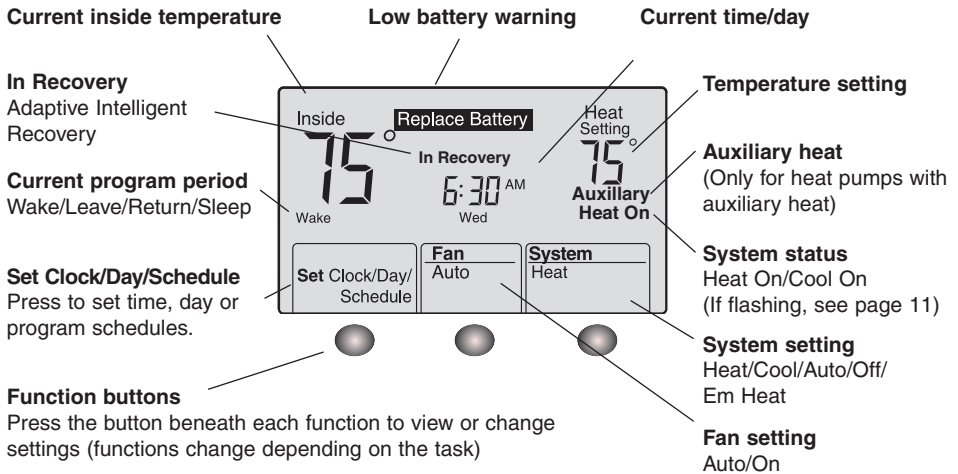

Battery replacement

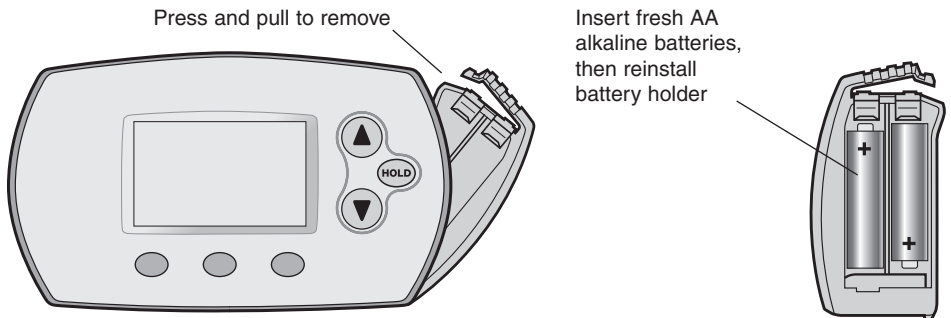

In case of difficulty

If you have difficulty with your Comfort Control, please try the suggestions below. Most problems can be corrected quickly and easily.

- Display is blank**
- Check circuit breaker and reset if necessary.
 - Make sure power switch at heating & cooling system is on.
 - Make sure furnace door is closed securely.
- Temperature settings do not change**
- Make sure heating and cooling temperatures are set to acceptable ranges:
- Heat: 40° to 90°F (4.5° to 32°C).
 - Cool: 60° to 99°F (15.5° to 37°C).
- Check temperature range stop settings (Function 27 & 28 on page 9).
- Heating system does not respond (“Heat On” appears on screen)**
- Check for 24 VAC at the equipment on the secondary side of the transformer between power and common. If voltage is not present, check the heating equipment to find the cause of the problem.
 - Check for 24 VAC between the heat terminal (W) and the transformer common. If 24 VAC is present, the Comfort Control is functional. Check the heating equipment to find the cause of the problem.
 - Check for loose or broken wires between the Comfort Control and the heating equipment.
- Cooling system does not respond (“Cool On” appears on screen)**
- Check for 24 VAC at the equipment on the secondary side of the transformer between power and common. If voltage is not present, check the cooling equipment to find the cause of the problem.
 - Check for 24 VAC between the cooling terminal (Y) and the transformer common. If 24 VAC is present, the Comfort Control is functional. Check the cooling system to find the cause of the problem.
 - Check for loose or broken wires between the Comfort Control and the cooling equipment.
- Fan does not turn on in a call for heat**
- Check Installer Setup, Function 3 (Fan Control), to make sure the fan control is properly set to match the type of system (see page 8).
- Heat/cool both on at same time, or heat does not turn off**
- Check Installer Setup, Function 1 (System Type), to make sure it is set to match the installed heating/cooling equipment (see page 8).
 - Check to make sure heating and cooling wires are not shorted together.
- Heating equipment is running in cool mode**
- Check Installer Setup, Function 1 (System Type), to make sure it is set to match the installed heating/cooling equipment (see page 8).
- Cannot change system setting to “Heat”**
- Check Installer Setup, Function 1 (System Type), to make sure it is set to match the installed heating equipment (see page 8).
 - Change Installer Setup, Function 12 (System Setting) to Manual or Auto Changeover (see page 9).

In case of difficulty

- Cannot change system setting to “Cool”**
 - Check Installer Setup, Function 1 (System Type), to make sure it is set to match the installed cooling equipment (see page 8).
 - Change Installer Setup, Function 12 (System Setting) to Manual or Auto Changeover (see page 9).
- “Heat On” is not displayed**
 - Change the System Setting to Heat, and set the temperature level above the current room temperature.
- “Cool On” is not displayed**
 - Change the System Setting to Cool, and set the temperature level below the current room temperature.
- “Cool On” or “Heat On” is flashing**
 - Compressor protection timeout is engaged. Wait 5 minutes for the system to restart safely, without damage to the compressor.

Accessories & replacement parts

Please contact your distributor to order replacement parts.

- Battery holder** Part Number THT02506
 - Cover plate assembly** Part Number BAYCOVER700A
- (Use to cover marks left by old thermostats.)

Specifications

Temperature Ranges

- Heat: 40° to 90°F (4.5° to 32°C)
- Cool: 60° to 99°F (15.5° to 37°C)

Operating Ambient Temperature

- 32° to 120°F (0° to 48.9°C)

Shipping Temperature

- -20° to 120°F (-28.9° to 48.9°C)

Operating Relative Humidity

- 5% to 90% (non-condensing)

Physical Dimensions

- 3-9/16" H x 5-13/16" W x 1-1/2" D
- 91 mm H x 147 mm W x 38 mm D

Electrical Ratings

Terminal	Voltage (50/60Hz)	Running Current
W (O) Heating	20-30 Vac	0.02-1.0 A
W1 W2 Heating	20-30 Vac	0.02-0.5 A
Y Cooling	20-30 Vac	0.02-1.0 A
Y2 Cooling	20-30 Vac	0.02-1.0 A
G Fan	20-30 Vac	0.02-0.5 A
X2 Emergency heat	20-30 Vac	0.02-1.0 A
F Heat pump reset	20-30 Vac	0.02-0.5 A

American Standard

HEATING & AIR CONDITIONING

6200 Troup Highway
Tyler, TX 75711-9010

www.americanstandardair.com

© U.S. Registered Trademark • Patents Pending
© 2008 American Standard Heating & Air Conditioning
All rights reserved
69-1833—02

Pub. No. 11-HD02D11-3 01/08