



S4 LED Light Kit DNL.S4.10000

Thank you for choosing DENALI

We know you would rather be riding your bike than wrenching on it, so we go the extra mile to make sure our instructions are clear and as easy to understand as possible. If you have any questions, comments, or suggestions don't hesitate to give our gear experts a call at 401.360.2550 or visit WWW.DENALIELECTRONICS.COM

Please Read Before Installing

DENALI products should always be installed by a qualified motorcycle technician. If you are unsure of your ability to properly install a product, please have the product installed by your local motorcycle dealer. DENALI takes no responsibility for damages caused by improper installation. **Caution:** When installing electronics it is extremely important to pay close attention to how wires are routed, especially when mounting products to the front fender, front forks, or fairing of your motorcycle. Always be sure to turn the handlebars fully left, fully right, and fully compress the suspension to ensure the wires will not bind and have enough slack for your motorcycle to operate properly.

Installation Tips

We strongly recommend using medium strength liquid thread locker on all screws, nuts, and bolts. It is also important to ensure that all hardware is tightened to the proper torque specifications as listed in your owner's manual. For included accessory hardware please refer to the default torque specifications provided below. Inspect all hardware after the first 30 miles to ensure proper torque specifications are maintained.

Bolt Size	in-lbs	ft-lbs	Nm
M3	10.0 in-lbs	-	1.0 Nm
M4	23.0 in-lbs	-	2.5 Nm
M5	44.5 in-lbs	3.5 ft-lbs	5.0 Nm
M6	78.0 in-lbs	6.5 ft-lbs	9.0 Nm
M8	-	13.5 ft-lbs	18.0 Nm
M10	-	30.0 ft-lbs	41.0 Nm
M12	-	52.0 ft-lbs	71.0 Nm

Hardware Sizing Guide

Not sure what size bolt you have? Use this ruler to measure screws, bolts, spacers, etc. Remember, the length of a screw or bolt is measured from the start of the "mounting surface" to the end of the screw, so only include the screw head when measuring countersunk screws.

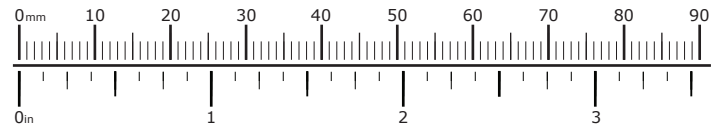

What's In The Box?

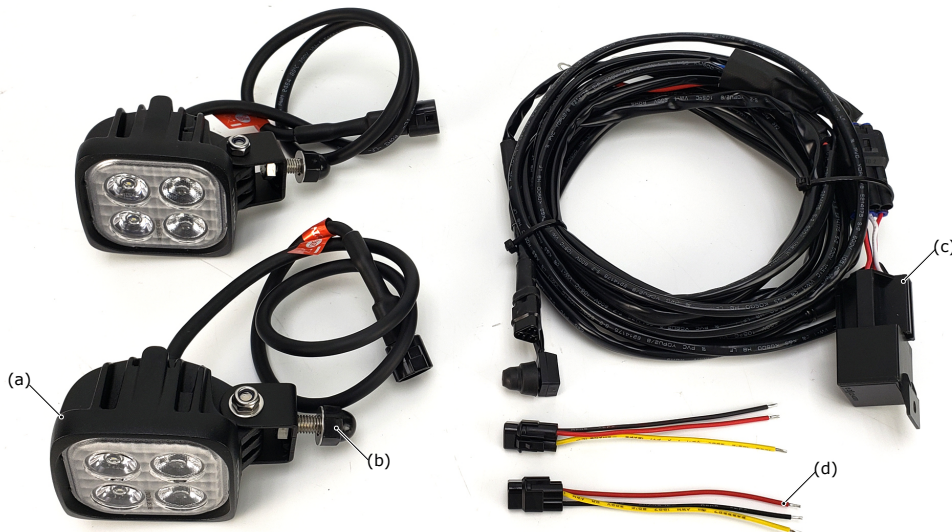

Kit Contents

- (a) LED Light Pod.....Qty 2
- (b) M8 Mounting Hardware.....Qty 2
- (c) HotSwap™ Single-Intensity Wiring Harness.....Qty 1
- (d) Wiring Pigtail.....Qty 1

Tools Required: 13mm Wrench, 10mm Wrench, 4mm Allen Key, Test Light

1. Mounting The Lights

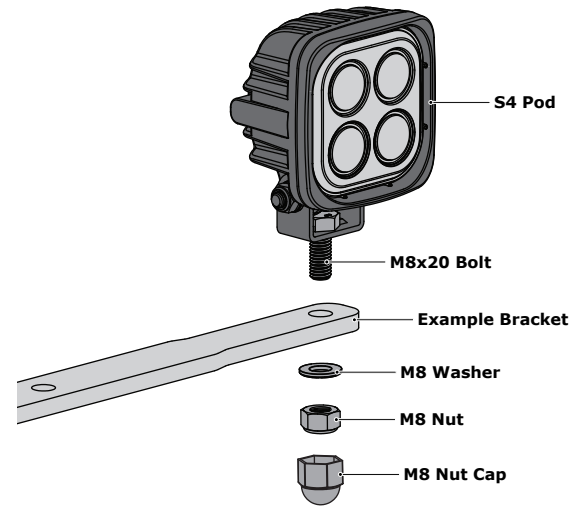
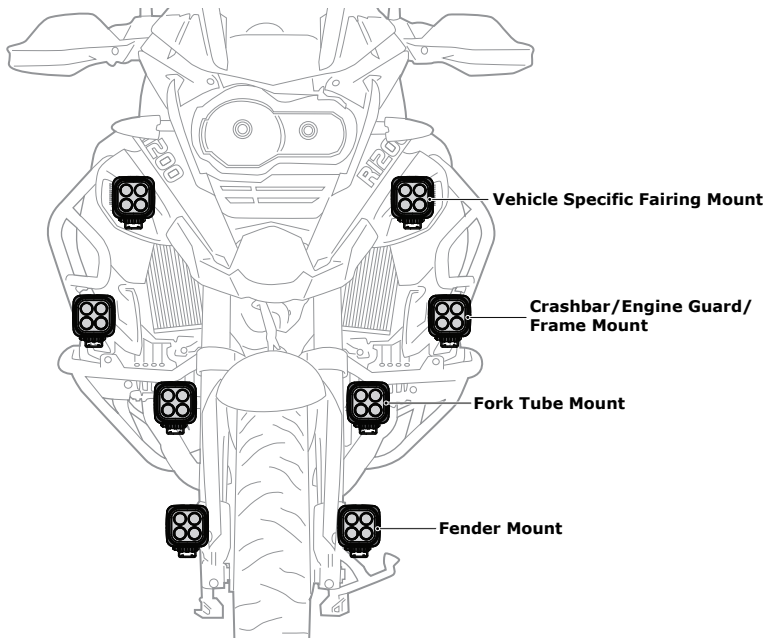

1.1 - Choosing The Mounting Location

DENALI offers dozens of universal and vehicle specific light mounts. To determine the best mounting location consider the following tips. For maximum beam distance at night, mount the lights higher up. For maximum day time visibility, mount the lights down low to increase your overall lighting footprint. To create the optimum lighting and visibility package, mount one pair of long distance spots up high for night time distance and one pair of flood or hybrid lights down low for day time visibility and night time fill.

Check out our full mounting application chart at DENALIELECTRONICS.COM to see all the mounting options available for your vehicle.

1.2 - Mounting The Light

Step One: Use a 13mm wrench and the included M8 screw, washer, nut and nut cap to attached the pods to the mounting bracket.

Step Two: Use the M8 plastic nut cap to cover the nut and exposed thread.

2. Wiring The Lights

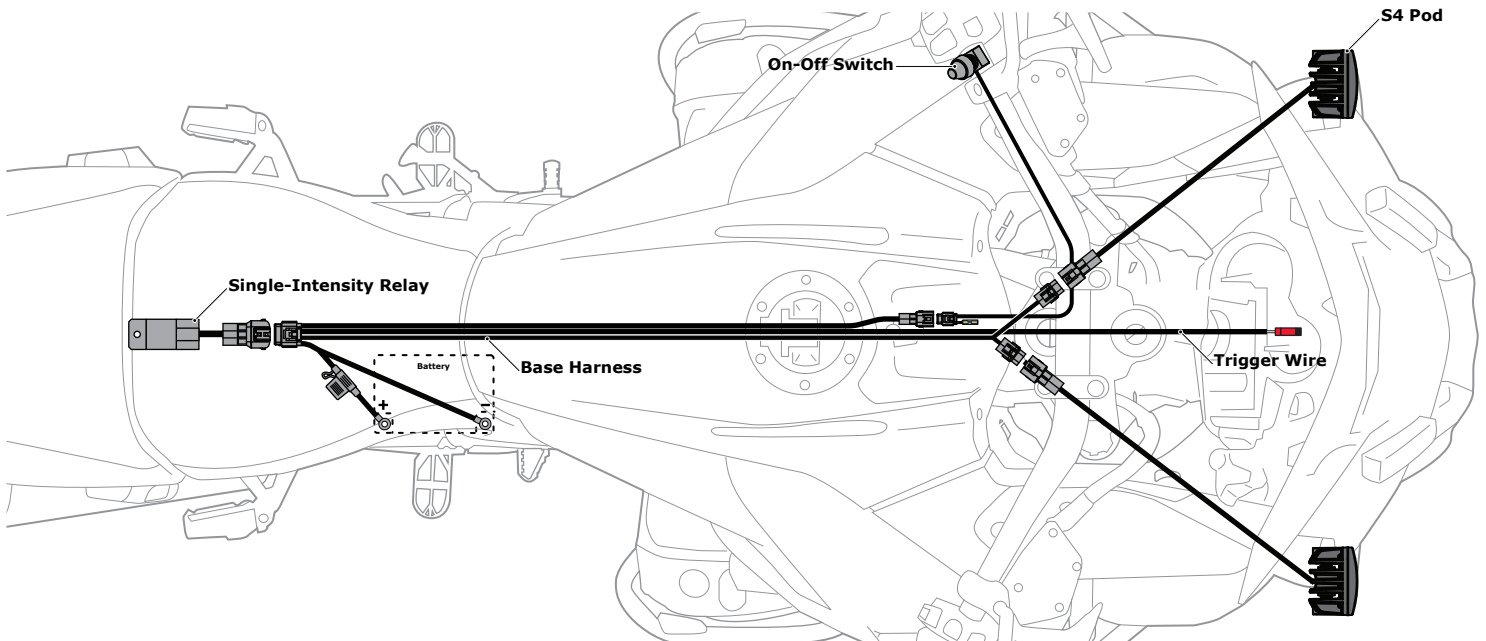

2.1 - Wiring Harness Overview

Our Standard Single Intensity Harness features high-quality waterproof components and a clever HotSwap™ design that enables an effortless swap from the standard Single-Intensity relay to our Dual-Intensity DataDim™ Controller (Sold Separately). If adding the DataDim™ Controller upgrade now, jump ahead and read Section 5 before returning to Section 2.2. If not, continue to Section 2.2 with peace of mind that you can always upgrade later, without having to rewire the lights.

Note: The DENALI harness with pods connected is 72 inches in length. DENALI Harness Extensions are available for purchase if extra length is required.

2.2 - Routing The Wiring Harness

Step One: Find a suitable location near the battery to store the Single-Intensity Relay.

Step Two: Begin routing the harness towards the mounted light pods. Secure the harness to the vehicle's frame along the way with the included zip ties. Be sure to avoid any moving components such as fan blades or suspension. Plug the light pods into the base harness.

Step Three: Route the switch wire to the location where the switch will be mounted and secure it to the vehicle using zip ties. See Section 3 for switch mounting options.

2. Wiring The Lights Continued

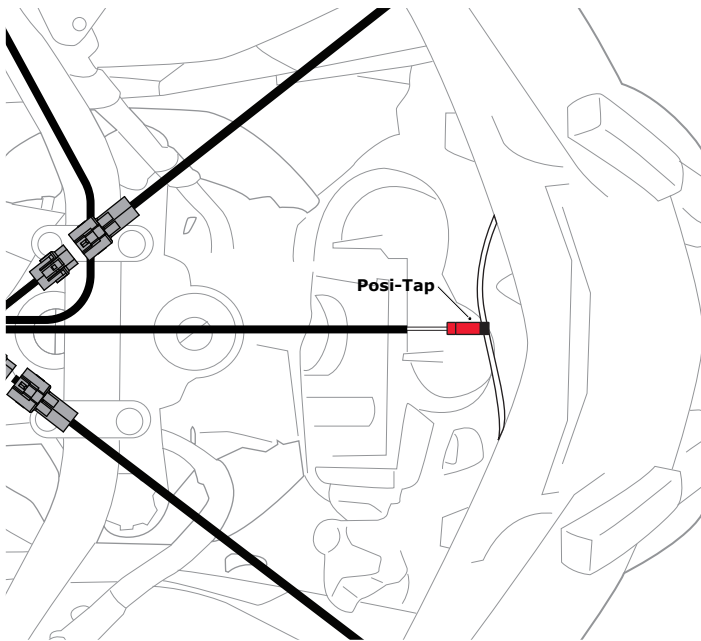

2.3 - Tapping Switched Power

Step One: Two examples of possible switched power sources are the low beam and tail light, however there are many other possible sources in most vehicles. The simplest way to identify switched power is to use a test light to probe connectors/wires while cycling the ignition. A clean switched power source will only be live when the ignition is cycled "ON", it should lose power when the ignition is cycled "OFF".

Step Two: Once a proper switched power source has been identified use the included Posi-Tap to tap the white trigger wire into the identified switched power source.

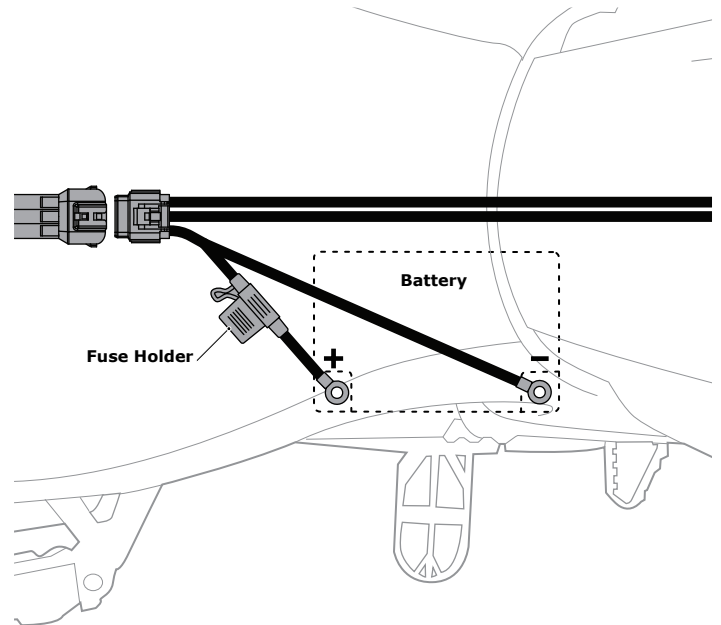

2.4 - Connecting To The Battery

Step One: Remove the fuse from the fuse holder.

Step Two: Access the vehicle's battery and disconnect the negative (-) and positive (+) terminals.

Step Three: Connect the DENALI wiring harness to the battery via the ring terminals, be sure the red wire lead with the fuse holder in-line goes to the positive (+) terminal of the battery.

Step Four: Re-install the fuse into the fuse holder.

Note: When possible, place the fuse holder in an easily accessible location for convenient service in the event of a blown fuse.

3. Mounting The Switch

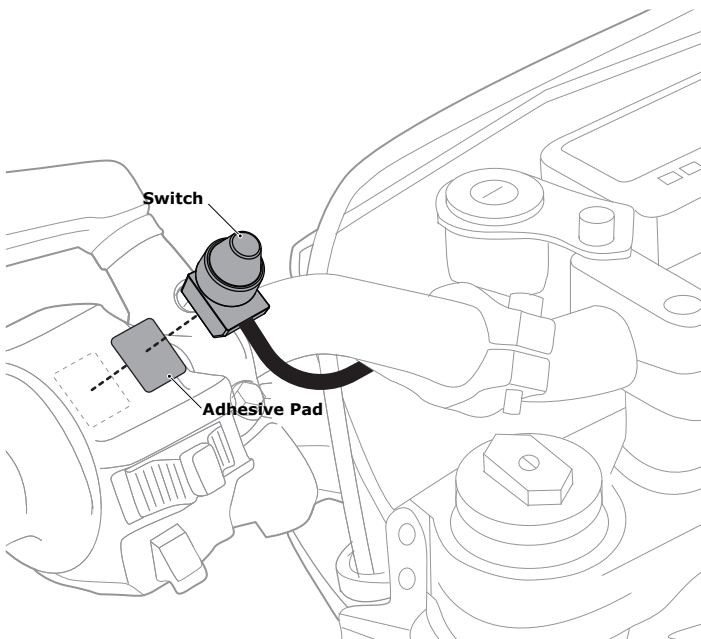

3.1 - Surface Mounting

Step One: Clean and prep the mounting surface and the bottom of the switch using an alcohol swab. Allow surfaces to fully dry.

Step Two: Peel away one side of the backing from the adhesive pad and adhere the pad to the bottom side of the switch.

Note: To ensure a stronger bond use a heat gun to warm the tape before applying to the surface.

Step Three: Peel away the remaining backing from the adhesive pad and adhere the switch to the mounting surface using moderate pressure.

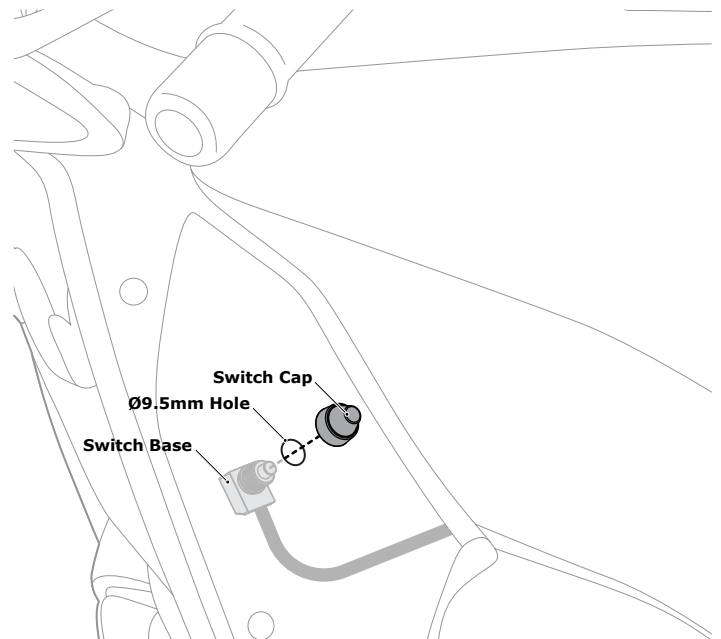

3.2 - Panel Mounting

Step One: Choose a suitable mounting location for the ON-OFF Switch. Be sure there are no wires, brackets or any other objects behind the panel that will prevent drilling of the mounting hole.

Step Two: Use a 9.5mm or 3/8" drill bit to drill the mounting hole into the panel.

Step Three: Unscrew the Switch Cap from the Switch Base.

Step Four: Pass the stem of the Switch Base up through the drilled hole and secure the switch into place by reinstalling the Switch Cap to the Switch Base.

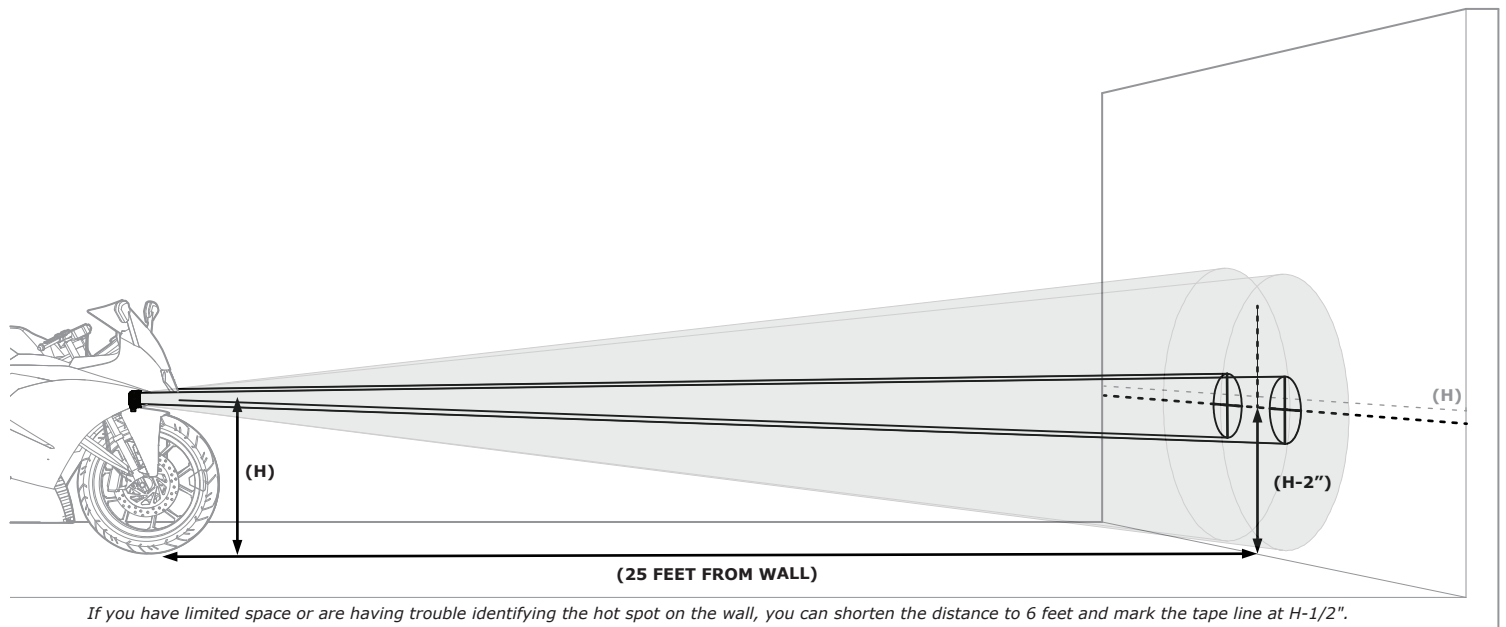

4.1 - Suggested Aiming Method

Step One: With someone sitting on the bike and holding it upright on level ground, position the vehicle 25 feet from a flat and vertical wall. Be sure the wall is large enough that both beams can be projected onto the wall. A garage door is a great place to perform this procedure.

Step Two: Measure the distance from the ground to the center of the light pods (H)

Step Three: Using tape, make a horizontal line that is 2 inches lower than the previous measurement from the ground to the center of the lights (H-2").

Step Four: Loosen the mounting and hinge bolts then aim each light so that the center of the hot spot aligns with the tape line on the wall. The lights should be aimed equidistant left and right from center line of the vehicle.

Step Five: Once final adjustments are made to the lights, tighten the mounting and hinge bolts.

Congratulations! The DENALI LED Light Kit has been successfully installed! Enjoy! Refer to *Figures 5 & 6* for detailed instructions for installing optional DENALI Light Kit accessories. To view a full list of accessories please visit WWW.DENALIELECTRONICS.COM

5. DataDim™ Controller Upgrade

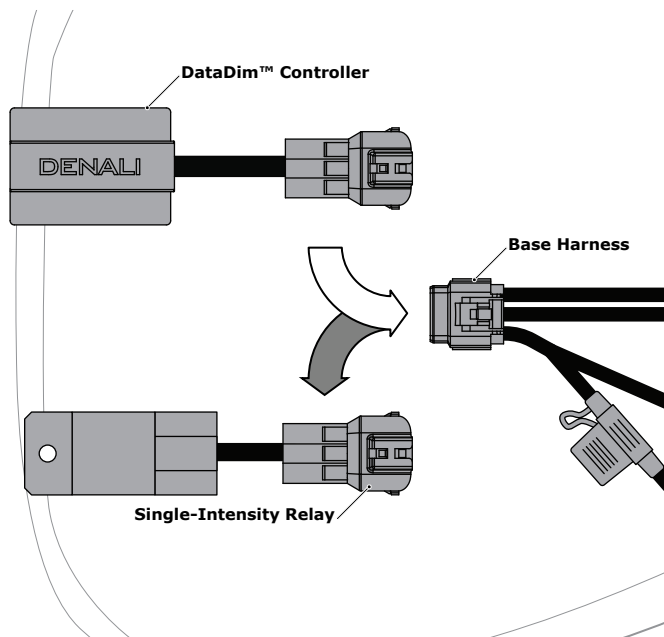

5.1 - DataDim™ Controller Overview

DENALI 2.0 Light pods are equipped with a dedicated 3rd-wire dimming circuit so we can use an external signal to reliably control the intensity of the LED chip at the source. Plug in our Dual-Intensity DataDim™ Controller to enable the DENALI lights to switch between half and full intensity with your vehicle's original high beam switch.

Step One: Unplug the Single-Intensity Relay from the Base Harness.

Step Two: Plug the Dual-Intensity DataDim™ Controller into the Base Harness.

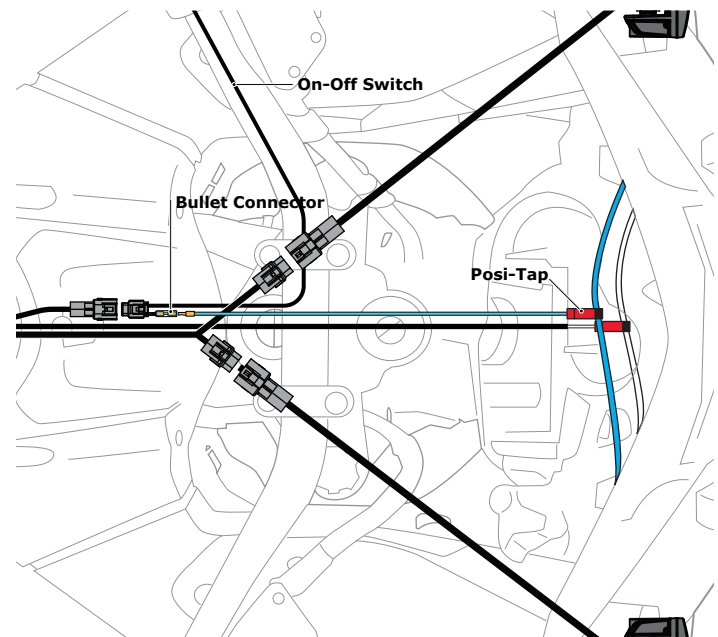

5.2 - Tapping The High Beam

Step One: Plug the blue Dual-Intensity Trigger wire into the bullet connector at the base of the On-Off Switch.

Step Two: Use a test light while toggling the vehicles high beam switch to identify the wire which receives power upon high beam activation.

Step Three: Once the high beam trigger has been identified, use the included Posi-Tap to tap into the wire.

Note: Some vehicles are equipped with LED headlights or other lighting systems that do not provide a clean 12v high beam trigger signal. See *Figure 6.1* for an overview of our independent dimming switch.

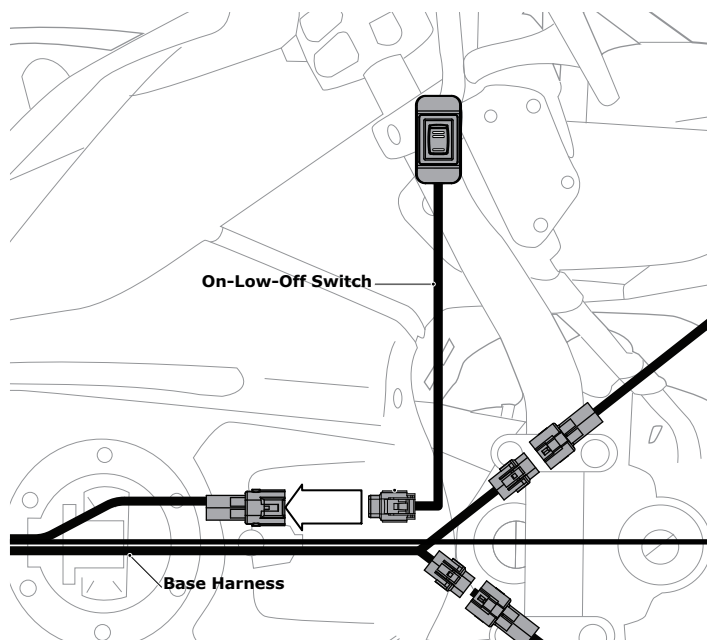

6.1 - Hi-Low-Off Switch Option

The DENALI Hi-Low-Off Switch enables independent dimming of the lights, separate from the vehicles OEM lighting system. This eradicates the issues presented by vehicles that do not provide a clean 12v high beam trigger signal. This switch is also a great option for those who want full independent control of their auxiliary lights.

Note: The Dual-Intensity DataDim™ Controller option is required to install this switch.

Step One: Unplug the standard On-Off switch from the base harness.

Step Two: Plug the Hi-Low-Off Switch into the base harness.

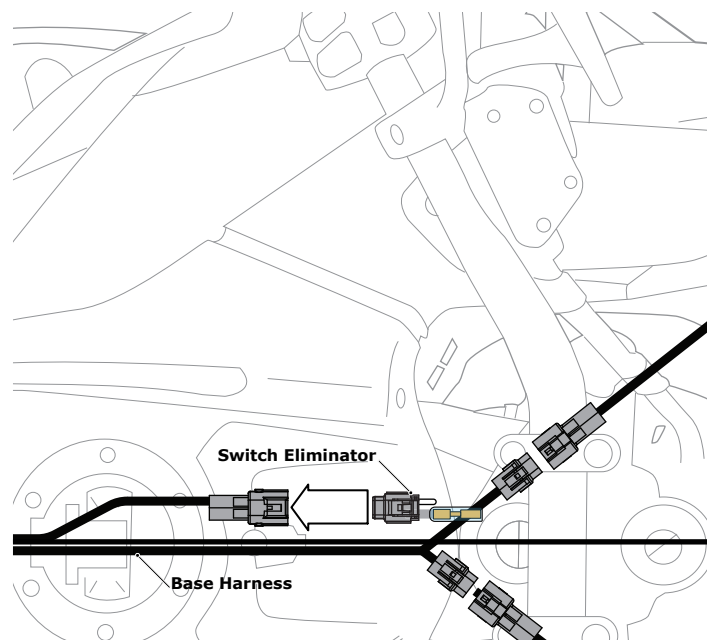

6.2 - Switch Eliminator Option

The DENALI Power Switch Eliminator plug replaces the standard On-Off switch so your lights will automatically power on and off with the vehicles ignition. Enjoy the convenience of having your lights on any time your bike is running and peace of mind knowing they will turn off with the ignition.

Note: This switch eliminator removes the ability to independently shut the auxiliary lights Off while the vehicle is running.

Step One: Unplug the standard On-Off switch from the base harness.

Step Two: Plug the Switch Eliminator into the base harness.