



V-Twin Wiring Harness For SoundBomb Horn

DNL.ELC.004

Thank you for choosing DENALI

We know you would rather be enjoying your vehicle than wrenching on it, so we go the extra mile to make sure our instructions are clear and as easy to understand as possible. If you have any questions, comments, or suggestions don't hesitate to give our gear experts a call at 401.360.2550 or visit WWW.DENALIELECTRONICS.COM

Please Read Before Installing

DENALI products should always be installed by a qualified technician. If you are unsure of your ability to properly install a product, please have the product installed by your local motorcycle dealer. DENALI takes no responsibility for damages caused by improper installation. **Caution:** When installing electronics it is extremely important to pay close attention to how wires are routed, especially when mounting products to the front fender, front forks, or fairing of a motorcycle. Always be sure to turn the handlebars fully left, fully right, and fully compress the suspension to ensure the wires will not bind and have enough slack for your motorcycle to operate properly.

Installation Tips

We strongly recommend using medium strength liquid thread locker on all screws, nuts, and bolts. It is also important to ensure that all hardware is tightened to the proper torque specifications as listed in your owner's manual. For included accessory hardware please refer to the default torque specifications provided below. Inspect all hardware after the first 30 miles to ensure proper torque specifications are maintained.

Bolt Size	in-lbs	ft-lbs	Nm
M3	10.0 in-lbs	-	1.0 Nm
M4	23.0 in-lbs	-	2.5 Nm
M5	44.5 in-lbs	3.5 ft-lbs	5.0 Nm
M6	78.0 in-lbs	6.5 ft-lbs	9.0 Nm
M8	-	13.5 ft-lbs	18.0 Nm
M10	-	30.0 ft-lbs	41.0 Nm
M12	-	52.0 ft-lbs	71.0 Nm

Hardware Sizing Guide

Not sure what size bolt you have? Use this ruler to measure screws, bolts, spacers, etc. Remember, the length of a screw or bolt is measured from the start of the "mounting surface" to the end of the screw, so only include the screw head when measuring countersunk screws.

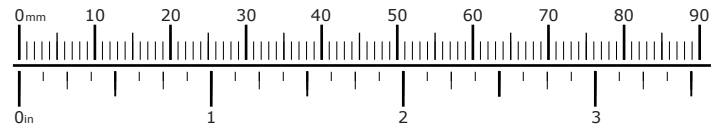

What's In The Box?



Kit Contents

- (a) Horn Wiring Harness.....Qty 1
- (b) Posi-Tap.....Qty 2
- (c) Female Spade Terminal.....Qty 2
- (d) Male Spade Terminal.....Qty 2

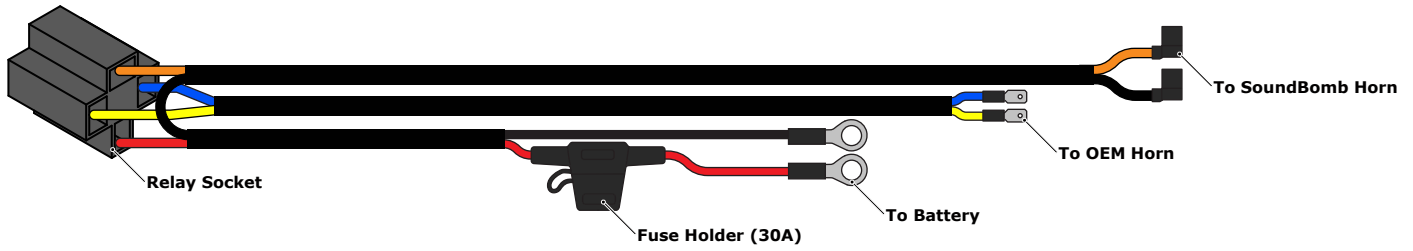

1.1 - Overview Of Horn Wiring Harness

The DENALI Horn Wiring Harness provides plug-n-play installation of a SoundBomb Compact Horn or SoundBomb Split Horn. The harness integrates with your vehicles OEM horn circuit, enabling the SoundBomb Horn to be operated right from the OEM horn button.

The Harness is 5½ feet long, giving you plenty of length for almost any application. In addition the kit includes all the necessary spare components to shorten the harness to the required length for your application.

2. Routing The Harness

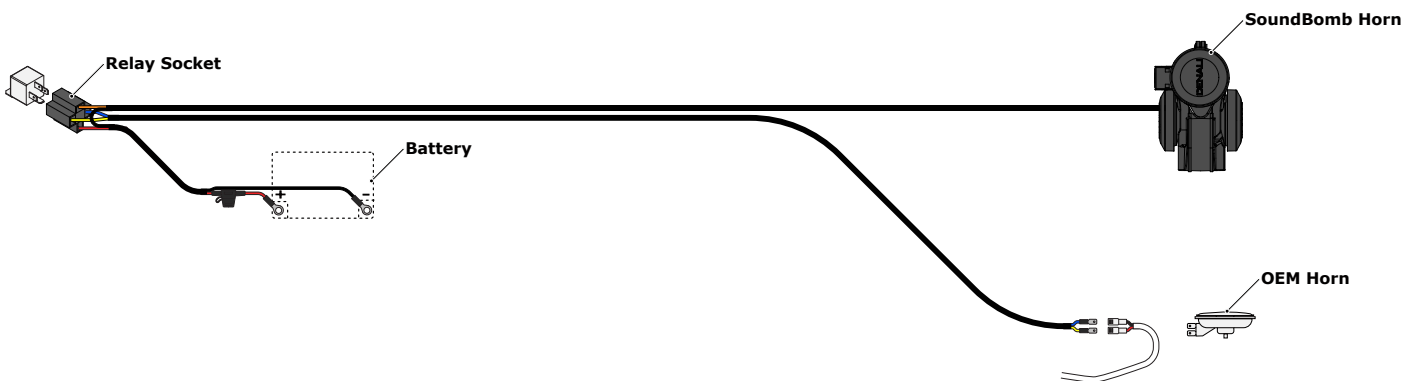

2.1 - Suggested Wire Routing

Step One: Start by positioning the Relay Socket in the vehicle, it will need to be located in close proximity to the battery so that the final connection to power can be made at the end of the install. (The battery terminal lead is 24 inches in length)

Note: Place the Relay Socket in an easily accessible location for convenient service in the event of a faulty relay.

Step Two: Route the lead for the SoundBomb Horn (Orange and Black Wires) towards the location in which you have installed your SoundBomb Horn. Secure the cable along the way using the supplied Zip Ties (e).

Step Three: Route the lead for the OEM Horn (Blue and Red Wires) towards the location of the OEM Horn. Secure the cable along the way using the supplied Zip Ties (e).

3. Connecting The Harness

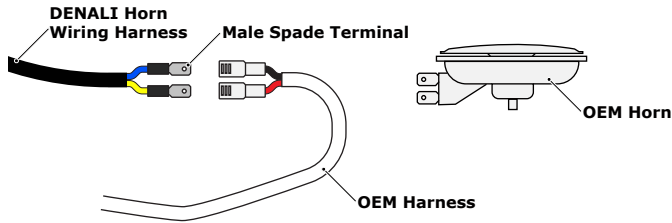

3.1 - Option One (Plug and Play to OEM Harness)

If your vehicle's OEM harness utilizes spade connectors you can plug and play connect the DENALI harness directly to your OEM harness. This wiring configuration will remove the OEM Horn from your vehicle's electrical system, only the SoundBomb Horn will emit sound. If you wish to leave the factory horn functioning, continue to Section 3.2.

Step One: Disconnect the OEM wiring harness from the OEM Horn.

Step Two: Identify which wire on the OEM harness is positive (+) and which wire is negative (-). Then connect the OEM wiring harness to the Male Spade Terminals on the DENALI Horn Wiring Harness. The Red Wire should be connected to the OEM positive (+) wire, the Blue Wire should be connected to the OEM negative (-) wire.

Note: If you need to shorten the DENALI Horn Harness simply cut the Red and Blue Wires to the desired length, then crimp the included spare Male Spade Terminals (d) onto the shortened wires.

Automotive Installation: Many modern vehicles use a specialty connector at the OEM horn connection. If your vehicle uses a specialty connector continue to Section 3.2 and use the Posi-Tap connectors to make the connection.

KTM Motorcycle Installation: The CAN bus system on most KTM motorcycles does not allow the OEM horn to be removed. It is required that you leave the OEM horn connected to prevent failure lights from appearing on the dash. Continue to Section 3.2 to connect to the harness leaving the horn installed.

BMW Motorcycle Installation: All modern BMW motorcycles use a specialty connector at the OEM horn connection. A DENALI Horn Wiring Adapter is necessary for plug-n-play connection with BMW Motorcycles and is available for purchase (P/N: DNL.WHS.10100). Alternatively you can continue to Section 3.2 and use the Posi-Tap connectors to make the connection.

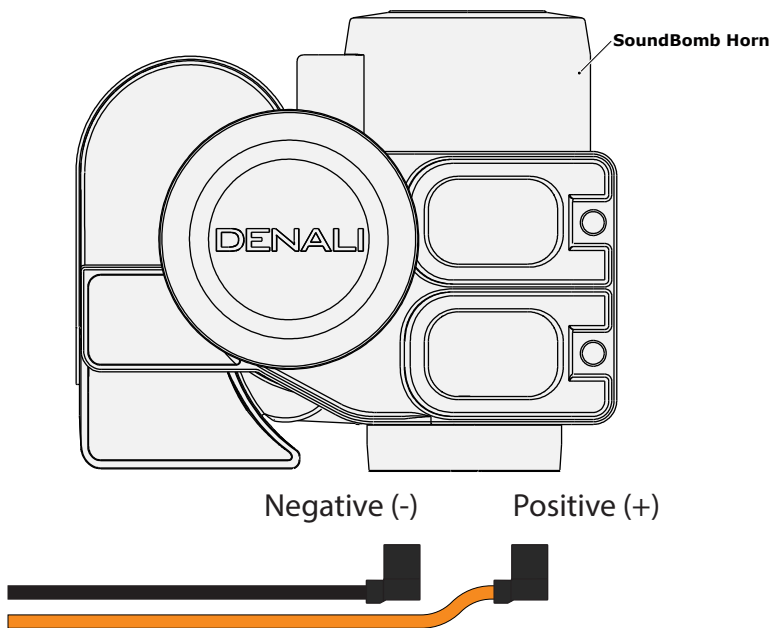

3.3 - Connecting The SoundBomb Horn

Step One: Connect the SoundBomb Horn to the Female Spade Terminals on the DENALI Horn Wiring Harness. Looking at the front of the horn, the negative (-) terminal will be on the left, and the positive (+) terminal will be on the right. The Orange Wire should be connected to the positive (+) terminal, the Black Wire should be connected to the negative (-) terminal.

Note: If you need to shorten the DENALI Horn Harness simply cut the Orange and Black Wires to the desired length, then crimp the included spare Female Spade Terminals (c) onto the shortened wires.

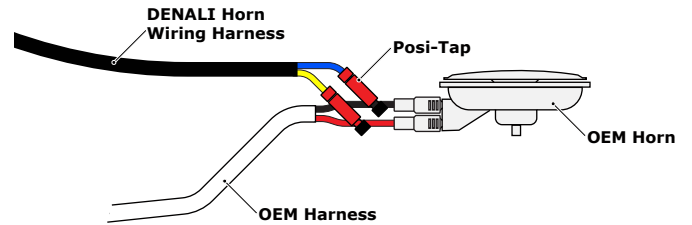

3.2 - Option Two (Posi-Tap to OEM Harness)

If your vehicle's OEM harness utilizes specialty connectors you will need to use the Posi-Tap connectors to connect the DENALI harness to the OEM harness. This wiring configuration will leave the OEM horn connected to your vehicle's electrical system, both the SoundBomb Horn and OEM horn will emit sound.

Step One: Cut the Male Spade Terminals off the ends of the Red and Blue wires on the DENALI Horn Harness and replace them with the Posi-Tap Connectors (b).

Note: If you need to shorten the DENALI Horn Harness simply cut the Red and Blue Wires to the desired length before attaching the Posi-Tap Connectors (b).

Step Two: Identify which wire on the OEM harness is positive (+) and which wire is negative (-). Then use the Posi-Tap Connectors (b) to tap the DENALI Horn Wiring Harness to the OEM harness. The Red Wire should be tapped to the OEM positive (+) wire, the Blue Wire should be tapped to the OEM negative (-) wire.

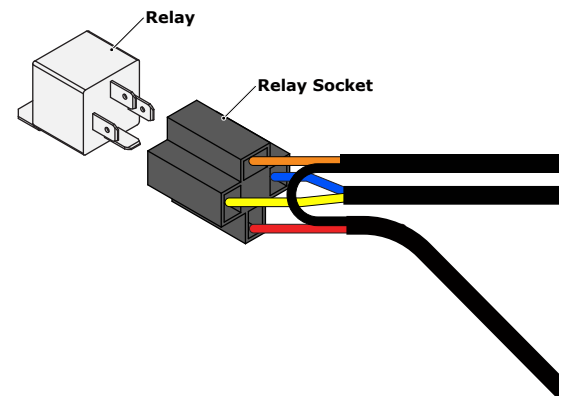

3.4 - Installing The Relay

Step One: Plug the relay that was included with your SoundBomb Horn into the Relay Socket on the DENALI Horn Wiring Harness.

3. Connecting The Harness (Continued) DENALIELECTRONICS.COM

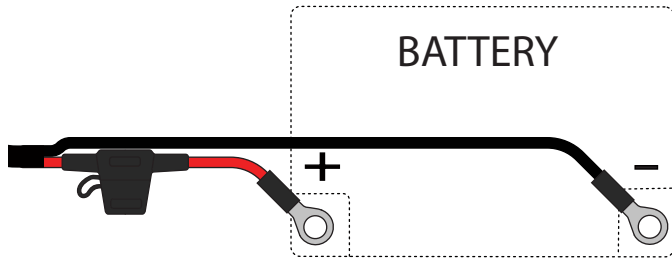

3.5 - Connecting To The Battery

Step One: Remove the fuse from the fuse holder.

Step Two: Gain access to the vehicle's battery and disconnect the negative (-) and positive (+) terminals.

Step Three: Connect the Horn Wiring Harness to the battery via the ring terminals. Be sure the Red Wire lead with the fuse holder goes to the positive (+) terminal of the battery.

Step Four: Re-install the fuse into the fuse holder.

Note: Place the fuse holder in an easily accessible location for convenient service in the event of a blown fuse.