

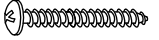







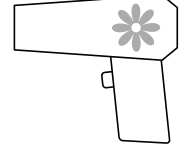
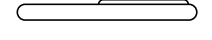
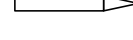

Please check components prior to assembly and then match the letters and numbers for each component with assembly diagrams overleaf.

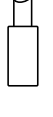
<p>Screws for assembly</p> <p>A  x 2</p> <p>B  x 8</p>	<p>C </p>	<p>D </p>	<p>E </p>	<p>F </p>	<p>G </p>	<p>H </p>	<p>I </p>
<p>J </p>	<p>1 </p>	<p>2 </p>					
<p>3  x 4</p>	<p>4 </p>	<p>5  x 4</p>	<p>6 </p>				

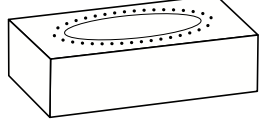
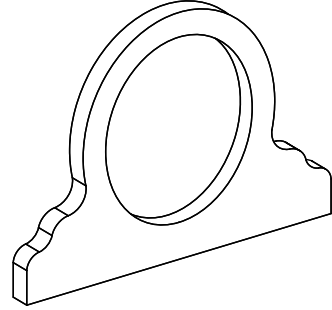
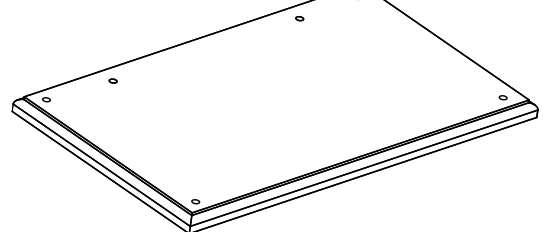
ATTENTION !

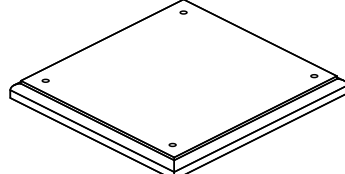
- The sharp tip of screws may scratch hands.
- Tighten all the screws before giving this toy to a child.
- Do not OVER tighten screws.
- Electric screwdrivers should NOT be used for assembly.
- Please be sure to remove packaging, all rubber bands, wire ties and tags or fastenings from the toy. They are not part of this toy and must be removed and discarded before giving it to your child.

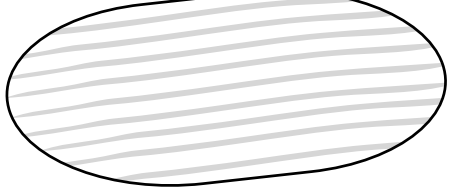
Please keep this packaging for future reference since it contains important information. Adult assembly required. Please read enclosed instructions before use. **SPECIFICATIONS, COLOURS AND CONTENTS MAY VARY FROM ILLUSTRATIONS.** Young children in play are unaware of potential dangers and hazards, therefore responsible adult supervision is essential.

WARNING:
CHOKING HAZARD - Small parts.
Not for children under 3 years.
Adult assembly required.



Kutoff Enterprises,
LLC 21930 Miles Road, Cleveland,
Ohio 44128
Made in China

Item No. 34036-1

A4 Size (Print Black only)

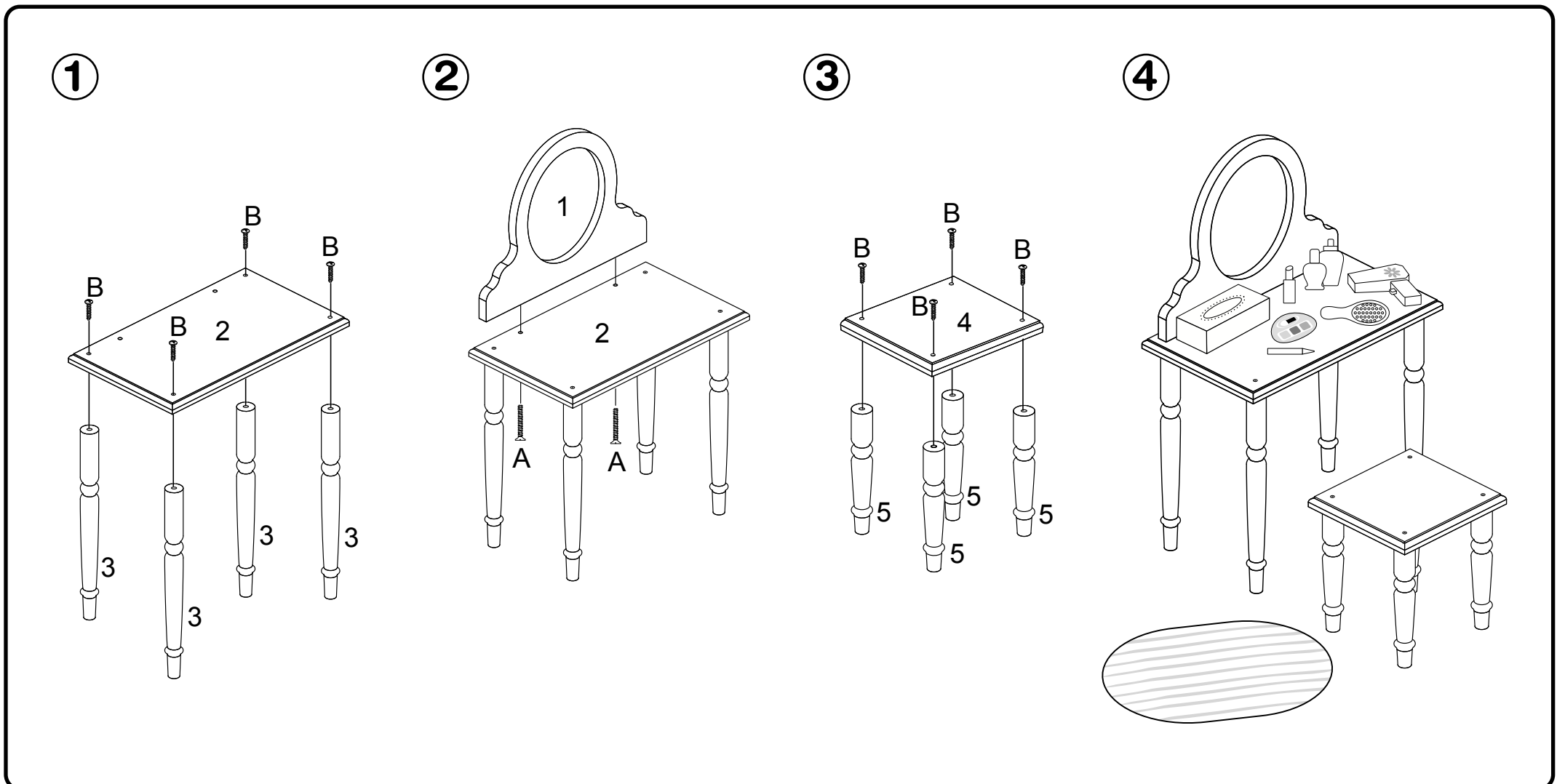

ATTENTION !

- The sharp tip of screws may scratch hands.
- Tighten all the screws before giving this toy to a child.
- Do not OVER tighten screws.
- Electric screwdrivers should NOT be used for assembly.
- Please be sure to remove packaging, all rubber bands, wire ties and tags or fastenings from the toy. They are not part of this toy and must be removed and discarded before giving it to your child.

Please keep this packaging for future reference since it contains important information. Adult assembly required. Please read enclosed instructions before use. **SPECIFICATIONS, COLOURS AND CONTENTS MAY VARY FROM ILLUSTRATIONS.** Young children in play are unaware of potential dangers and hazards, therefore responsible adult supervision is essential.

WARNING:
CHOKING HAZARD - Small parts.
Not for children under 3 years.
Adult assembly required.



Kutoff Enterprises,
LLC 21930 Miles Road, Cleveland,
Ohio 44128
Made in China

Item No. 34036-1

A4 Size (Print Black only)